

WEILER



75TH
ANNIVERSARY
1944 - 2019



Fifth Edition

Solutions for Cutting, Grinding, Cleaning and Finishing.



WHY WEILER



If you think Weiler is an old fashioned wire brush manufacturing company, you'd be dead wrong. In fact, today Weiler Abrasives is a global manufacturer of surface conditioning solutions with customers in over 80 countries and nearly 1,500 employees around the world.

Headquartered in the beautiful Pocono Mountains of Pennsylvania, we are proud of the fact that we have built a **progressive, innovative, and high growth company** headquartered right here in the USA. Our world class products are designed and built by Weiler co-workers who embrace our commitment to customers, the community, and to one another.

In 2019 we celebrate our **75th anniversary**. The celebration is focused on our customers, co-workers and community to thank them for contributing to the growth and longevity of the company — once a small jewelry polishing brush business and today a **global abrasives leader**.

At Weiler Abrasives, we want a culture where people have fun, are valued for their contributions and are encouraged to grow and try new ways of doing things. **Leading the Weiler Way** is our guide to making Weiler Abrasives both a great place to work and a great partner to our customers.

For those who want a competitive edge and productivity-enhancing solutions for cleaning, grinding, cutting, deburring and finishing, Weiler Abrasives is a premier manufacturer who forges collaborative, problem-solving relationships with our customers.

SOLUTIONS FOR ...

METAL FABRICATION



Time is money. The more time spent building a product, the more it costs. And every step adds time. Grinding. Cutting. Cleaning. Finishing.

You want solutions to get the job done. Done right — but done fast.

We hear you.

Before, during and after the weld, we have you covered. Superior performance means maximum aggression and long life. Saving more time. For more productivity. And more profit.

That's the Weiler Abrasives difference.

INDUSTRIAL PRODUCTION



There may be hundreds of differences between your industrial production operation and a competitor's. The ones that matter to you are far fewer.

Cost. Quality. Productivity.

Weiler helps sharpen your competitive edge. Like every production operation is different, so is every production challenge. One solution does not fit all. Weiler experts can examine your specific deburring, cleaning and grinding challenges and recommend customized solutions—solutions designed to optimize your operation.

Those solutions can reduce costs. Improve quality. Maximize productivity. And make your competition ... less competitive.

Don't compromise. Optimize.

MAINTENANCE, REPAIR & OPERATIONS



The facility doesn't run itself. In fact, keeping things going is more than a full-time job. So you depend on MRO supplies to be ready at a moment's notice — if not before.

Weiler has you covered. We know that when certain products are out of stock, certain activities come to a stop. You aren't going to let that happen on your watch — and neither are we.

No matter where you need them. No matter what they are. If they're Weiler products, they're only a click or a phone call away.

You keep the shop running – Weiler Abrasives stands ready.



INDUSTRIAL PRODUCTION



MRO

Weiler Abrasives works in various industrial settings across the globe to solve tough challenges, enabling businesses like yours to get more done, more efficiently.

Electronics
Railway
Steel
Aircraft
Construction
Painting
Food Processing
Pipeline
Transportation
Foundry

Heavy Equipment
Welding
Pharmaceutical
Nuclear
Trucking
Ship Building
Petroleum
Farming
Automotive
Primary Metals

Biomedical
Aerospace
Building Products
Recreational
Vehicles
Agricultural
Equipment
Machining
Fabricating
Gear



METAL FABRICATION



TABLE OF CONTENTS

New Products.....	6
Safety Information.....	8
Weiler Process Solutions (WPS).....	9
Workshops for Warriors Campaign.....	22

BONDED ABRASIVES 10-21

Technical Information.....	11-13
Cutting Wheels.....	14-17
Small Diameter Wheels.....	16-17
Grinding Wheels.....	18-19
Combo Wheels.....	20
Pipeline Wheels.....	21

COATED ABRASIVES 22-42

Technical Information.....	24-27
Flap Discs.....	28-33
Resin Fiber Discs.....	34-37
Blending Discs.....	38
Trim-Kut® Discs.....	39
Flap Wheels.....	40-41
Shop Rolls.....	42

NON-WOVEN ABRASIVES 43-46

Technical Information.....	44
Unitized Wheels.....	44
Interleaf Flap Wheels.....	45
Hand Pads.....	45
Surface Conditioning Discs.....	46

POWER BRUSHES 47-99

Technical Information.....	48-56
Knot Wire Wheels.....	57-63
Weld Cleaning Brushes.....	62-63
Crimped Wire Wheels.....	64-71
Nylon & Tampico Wheels.....	72
Cup Brushes.....	73-75
Stem-Mounted End Brushes.....	76-79
Crosshole Deburring Brushes.....	80
Power & Hand Tube Brushes.....	81-85
Crossflex Honing Brushes.....	86-89
Miniature Brushes.....	90-91
Non-Sparking Brushes.....	92-93
Strip Brushes.....	94-97
Wide Face Brushes.....	98-99

NYLOX® BRUSHES 100-128

Technical Information.....	102-110
Engineered Products & Solutions.....	111
Troubleshooting Guide.....	112
Small Feature Deburring Products.....	113-117
Flat Surface Deburring Products.....	118-121
Targeted Feature Deburring Products.....	122-124
Application Engineered Wheels.....	125
Adapters & Drive Arbors.....	126-127
FME Area Product Solutions.....	128

PACKAGED PRODUCTS 129-139

Vending-Ready Products.....	129-133
Display Packaged Products.....	134-139

MAINTENANCE 140-175

Technical Information.....	142-143, 168
Brooms, Sweeps & Handles.....	144-151
Upright Brooms, Dusters & Dust Pans.....	152-153
Squeegees & Window Brushes.....	154
Vehicle Care Products.....	155
Scrub Brushes.....	156-158
Mops & Accessories.....	159-160
Masonry & Applicator Brushes.....	161-162
Scratch Brushes.....	163-165
Flue Brushes.....	166
Tube Fitting Brushes.....	167
Paint & Parts Cleaning Brushes.....	169-171
Chip & Oil Brushes.....	172
Marking Brushes.....	173
Glue & Acid Brushes.....	174
Paint Rollers & Accessories.....	175

LEARN MORE:
WEILERABRASIVES.COM
 See Page 7 for Updated Capabilities!

HOW CAN WE HELP YOU? CONTACT US TODAY!

To place an order or locate a distributor in your area, contact our Customer Experience Team at 800-835-9999 or orders@weilerabrasives.com.

For more information and to schedule a consultation with a Weiler Process Solutions expert visit: weilerabrasives.com/wps. To discuss specific requirements with a specialist call: 800-835.9999.

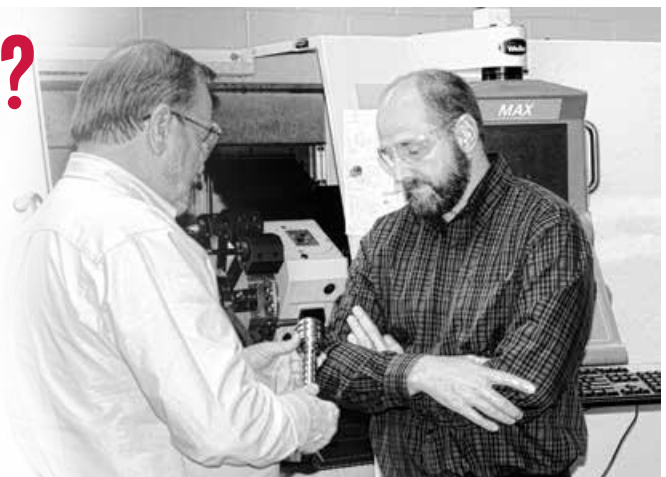

WHAT'S NEW?

BONDED ABRASIVES

SMALL DIAMETER WHEELS

We have expanded our line of small diameter cutting and snagging wheels for high-speed die grinders to include Tiger AO, Tiger Zirc and Tiger Ceramic. These wheels are designed for long life and fast cutting and provide end-users in the metal fabrication and shipbuilding industries with increasing levels of cutting performance to meet their needs.



Page 16-17

TIGER PIPELINER WHEELS

Designed to work right out of the box, aggressively digging in when grinding beads, facing the land or prepping transitions – throughout the life of the wheel. This eliminates operators' inclination to chip the wheels to gain a bite, reducing downtime and increasing safety. A unique design, along with a special mix of top-quality abrasive grains, delivers a fast cut rate and easily removes wagon tracks from the weld bead, while a strong bond delivers long wheel life without glazing on fresh welds. The bond has been formulated for reduced chatter and vibration, which provides more comfortable operator use and keeps the wheel from jumping out of the bevel.



Page 21

TIGER MECH WHEELS

These wheels are the first of their kind in the industry – manufactured slightly thinner than a 1/8-inch wheel to fit the thinner bevel. These high-performance wheels are capable of grinding the starts and stops of the weld bead without widening or scarring the narrower channel created by the mechanical pipe welding process. These ceramic-infused wheels for notching applications include a special blend of high-performance grains. They are designed to work on J and K bevels, while offering superior cut and product life.



Page 21

COATED ABRASIVES



Pages 34-37

RESIN FIBER DISCS

Our expanded line is designed to help our users optimize grinding time on a wide variety of applications. Weiler Tiger and Wolverine RFDs deliver serious grinding solutions.

POWER BRUSHES

ROUGHNECK® MAX WHEELS

Our re-engineered Roughneck Max brushes deliver MAXimum impact and up to twice the life. Combine that with the hardest, strongest wire and an improved knot design to MAXimize cleaning power and you have a brush that you can trust when your name is on the line.



Page 62

CROSSFLEX HONING BRUSHES

Our new brush line is designed to provide machinists with performance and value for their professional honing applications. Available in a large variety of diameters and with heavy-duty options, they provide a surface finish free of metal burrs and are ideal for manual or automated use in automotive; marine, oil and gas production; aerospace; and tube, pump and valve production applications.



Pages 86-89

INDUSTRIAL GRINDING SOLUTIONS

High performance industrial grinding products and engineered solutions that deliver a competitive edge through increased productivity and profitability.

World-class capabilities that deliver an impact on your business...

- ▶ Best in class performance
- ▶ Global R & D capabilities
- ▶ New platform technologies
- ▶ Advanced manufacturing capabilities
- ▶ Environmentally conscientious with a green footprint
- ▶ On-site engineering and technical support

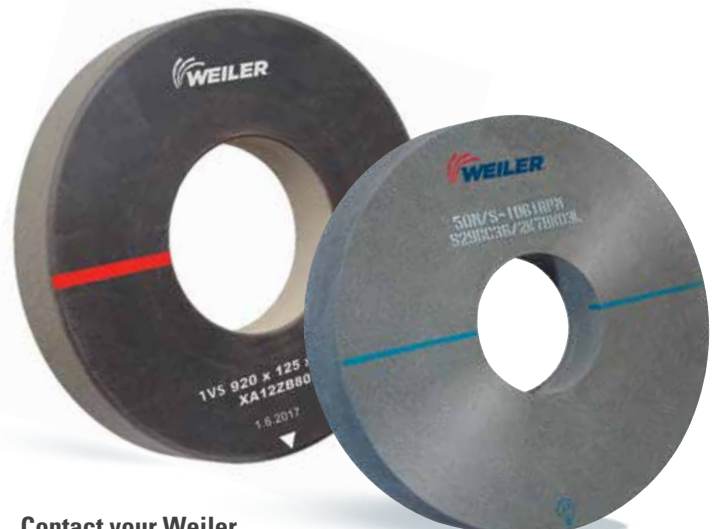

Contact your Weiler representative for more information

INTRODUCING THE NEW WEILERABRASIVES.COM

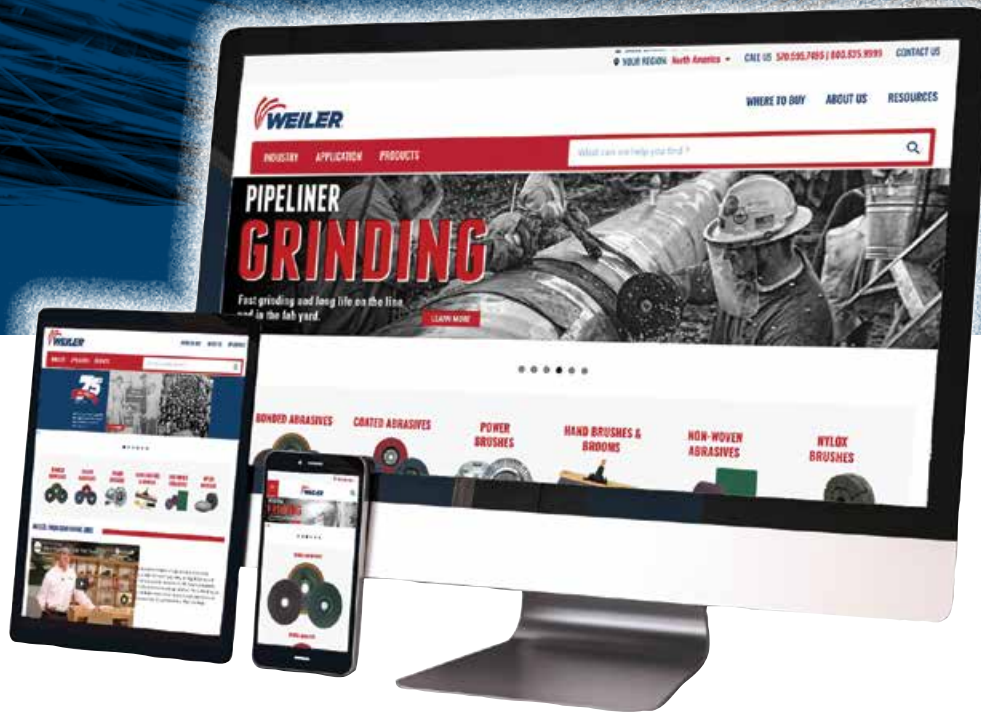

YOU ASKED. WE LISTENED.

The new website is built on a modern ecommerce platform that will significantly improve the user experience and provide a full path to purchase through select Weiler Abrasives distribution partners. Several of the most notable enhancements include:

- **Dynamic Search** – Quickly find products, solutions and resources for all your surface conditioning needs
- **Enhanced Content** – Improved product content, solution guides, and additional resources help users select the right product for their job and get the most out of their products
- **Mobile Friendly** – Mobile friendly technology ensures an exceptional user experience on any device
- **Where to Buy** – Improved "Where to buy" functionality allows visitors to quickly find a local branch or online seller of Weiler Abrasives products
- **Easy Access to Resources** - Find literature, Safety Data Sheets, videos, and articles directly on the product page with no more confusion

ABRASIVES
NON-WOVEN ABRASIVES
POWER BRUSHES
NYLOX BRUSHES
PACKAGED ITEMS
MAINTENANCE

SAFETY INFORMATION

All of Weiler's products are made to the strictest quality standards and specifications and are designed to provide superior work performance and safe operation when used properly.

WARNING: Failure to observe safety precautions may result in injury.

Many manufacturers mark some safety warnings, recommendations and usage restrictions directly on the product. However, it is not always practical to include even the most limited safety information on the product itself. Therefore, the operator **MUST READ** and **FOLLOW** all instructions supplied in or on the product container as well as those marked on the product.

SAFETY STANDARDS - ESTABLISHED BY THE AMERICAN NATIONAL STANDARDS INSTITUTE

Weiler power brushes and abrasives conform to the ANSI standards listed below. All operators of power brushes and abrasives must comply with these safety standards.

- ANSI B165.1 "Power Tools - Power Driven Brushing Tools - Safety Requirements for Design, Care and Use"
- ANSI B7.1 "Safety Requirements - For the Use, Care and Protection of Abrasive Wheels"

AVAILABILITY OF ANSI STANDARDS

Based on the collective experience of the American Brush Manufacturers Association Industrial Division members (ANSI B165.1) and the United Abrasives Manufacturers Association's Bonded Division (ANSI B7.1), both ANSI Standards are referenced and provided solely as a public service for the guidance of the users of the members' products. All Brush and Abrasive recommendations are not necessarily complete with respect to any particular application and common sense safety considerations should generally be followed. Any applicable federal, state, local law or regulation must be strictly adhered to and is controlling over any recommendation contained herein.

TOOL/WORK REST

On bench grinders, tool/work rests should be used to support the work-piece during use. It should have a maximum opening of 1/8" to the product face. Only adjust the rest when the product is not in motion.



Read Instructions



Safety Goggles



Face Shield



Protective Clothing



Hearing Protection



Gloves



Respiratory Protection

SAFETY TRAINING

Weiler products are designed and manufactured to the strictest standards to ensure the highest level of quality and safety. But safety doesn't stop there; raising awareness of basic safety practices and thinking about safety before the job starts — and after the job is complete — can help curb accidents and injuries in the shop. That's why Weiler offers customers a Safety Training Program based on the SPOT (Speed & Size, Pressure, Orientation, Time) methodology to help promote safe and proper product usage.

Deploying our **SPOT SAFETY TRAINING PROGRAM** in your facility helps improve safety, regardless of your application or work environment.

See page 54 for more information or contact your Weiler representative to request S.P.O.T. Training at your facility.



ASK THE EXPERTS



WHY WEILER

BONDED ABRASIVES

COATED ABRASIVES

NON-WOVEN ABRASIVES

POWER BRUSHES

NYLOX BRUSHES

PACKAGED ITEMS

MAINTENANCE

WPS Increasing Competitive Capability Through Process Improvements

Weiler Process Solutions (WPS) is a structured application engineering program designed to provide Weiler customers with engineering support to identify value added cost savings opportunities in their respective processes.

WPS is a comprehensive process where our expert application engineers accesses a specific process in order to identify improvement opportunities resulting in quantifiable cost savings.

WPS Benefits Include:

- Reduced cycle times
- Reduced consumable and tooling cost
- Reduced energy consumption
- Documented cost saving
- Elimination of process variability
- Elimination of bottlenecks
- Elimination of rejections and rework
- Reduced work in process
- Documented best practices

For more information and to schedule a consultation with a WPS expert visit: www.weilerabrasives.com/wps. To discuss specific requirements with a specialist call: 800-835.9999.



BONDED ABRASIVES

PERFORMANCE YOU EXPECT

Weiler's line of bonded abrasives deliver consistency and performance to Metal Fabrication professionals. This high quality line includes cutting, grinding and combination wheels that are available in performance tiers, offering a choice between long life, fast cut, or both.

Weiler raised the bar by adding Tiger Aluminum wheels to its bonded abrasives line. Tiger Aluminum wheels are specifically designed for high performance cutting on aluminum. These wheels blend abrasive grains with Weiler's non-loading formula, resulting in a fast and consistent cut rate on aluminum.

Technical Information	11-13
Cutting Wheels	14-17
Small Diameter Wheels	16-17
Grinding Wheels.....	18-19
Combo Wheels.....	20-21
Pipeline Wheels	21





REDUCING VIBRATION

Excessive vibration binds the wheel and makes it difficult to control through the cut.

Check the mounting/clamping point. Ensure that the work piece is clamped securely and as close as possible to the mounting point or vice to allow safe and adequate clearance of the tool, guard and hands.



PUSH VERSUS PULL

Weiler's Tiger grinding wheels are instantly aggressive out of the box. When possible, it is most effective to begin grinding on the pull stroke. This will minimize the risk of undercutting or gouging.

It is common to use more pressure through the push stroke and less pressure during the pull stroke. The most efficient grinding technique requires consistent pressure in both directions. Do not use excessive pressure in either direction and allow the grains to do the work. Overpowering a grinding disc will NOT increase cut rate and WILL break down at a faster rate, reducing disc life.



CUTTING ANGLE IRON OR SQUARE TUBING

When clamping angle iron on a table or bench, it is important to fix the piece with the corner perpendicular to the table. When clamping in a vise, the preferred approach is from the corner.

When cutting material with larger surface area like square tubing or angle iron, beginning the cut from a corner reduces friction and will minimize kick-back. After allowing the tool to reach full speed, engage the piece from the corner and work the wheel through the material using consistent pressure. Use light to moderate pressure to work through the cut being careful not to plunge the wheel too deeply into the tube. Depth of cut will depend on wall thickness.



ROUND BAR AND ROUND TUBE

Cutting round bar stock or tubing, is easier since the countered surface provides the same contact surface regardless of angle. Applying light to moderate pressure and consistent movement will provide the most efficient cut and minimize heat build-up.



HEAT DISCOLORATION

Heat is the enemy of any abrasive. To minimize discoloration, use a smooth, consistent rocking motion through the cut.

Approach from the corner and use light pressure and a consistent motion through the cut for the fastest cut-rate and prolonged wheel life. Applying too much pressure through the cut causes increased friction and heat build-up. This can cause increased heat discoloration of the work piece and reduced wheel life.

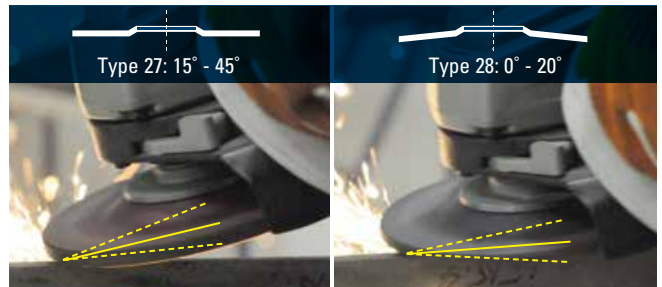

GRINDING ANGLES

The optimal grinding angle for a 1/4" Type 27 grinding wheel is between 15 and 30 degrees. Generally speaking, the steeper the grinding angle, the more aggressive the cut. Grinding at lower angles can prolong life, but will compromise cut rate. When grinding shallow on harder materials, chatter and vibration can become a factor.

When lower grinding angles are required, consider a Type 28 grinding wheel. Its unique saucer profile provides increased aggression at lower grinding angles while also allowing access in tighter areas, such as corners, fillets, and overhangs.

SELECTING THE RIGHT WHEEL

Weiler's cutting, grinding and combination wheels help Metal Fabrication professionals get the most demanding jobs done right, and done fast. Our high quality line helps you select the best solution for your toughest jobs. Whether you're looking for serious stock removal, beveling, grinding, notching, cutting or edge softening, Weiler will get it done for you.



<p>P MAX PERFORMANCE SUPERIOR LIFE & CUT</p>	<p>CUT RATE: ●●●●● LIFE: ●●●●●</p>	<p>TIGER® CERAMIC Self-sharpening and cool – grinds at lower temperatures with less friction and less effort, reducing heat discoloration of the work piece.</p>	<p>GRAIN TYPE Ceramic alumina</p> <p>CONTAMINANT FREE CONTAIN LESS THAN 0.1% IRON, SULFUR & CHLORINE</p>	<p>BEST ON STEEL / METAL STAINLESS HARD-TO-GRIND</p> <p>(Hard-to-Grind metals include tool steel, inconel, high nickel alloy, titanium and armored steel)</p>
<p>P HIGH PERFORMANCE FAST CUT & LONG LIFE</p>	<p>CUT RATE: ●●●●○ LIFE: ●●●●●</p>	<p>TIGER ZIRC Self-sharpening grains retain a high cut rate throughout the life of the wheel for exceptional performance.</p>	<p>GRAIN TYPE Cutting/Combo: Zirconia alumina Grinding/Pipeline: Zirconia alumina + ceramic alumina infusion</p>	<p>BEST ON STEEL / METAL</p> <p>(includes structural steel and cast iron)</p>
<p>TIGER INOX TIGER ALUMINUM</p>	<p>TIGER INOX CUT RATE: ●●●●○ LIFE: ●●●●●</p>	<p>TIGER INOX Tiger INOX wheels deliver a worry-free solution for stainless steel applications.</p>	<p>GRAIN TYPE White aluminum oxide</p> <p>INOX CONTAMINANT FREE CONTAIN LESS THAN 0.1% IRON, SULFUR & CHLORINE</p>	<p>BEST ON STAINLESS</p> <p>(and harder grade steel)</p>
<p>TIGER ALUMINUM</p>	<p>TIGER ALUMINUM CUT RATE: ●●●●○ LIFE: ●●●●●</p>	<p>TIGER ALUMINUM Weiler's non-loading formula delivers a fast and consistent cut rate on aluminum.</p>	<p>GRAIN TYPE Silicon carbide / aluminum oxide blend</p> <p>CONTAMINANT FREE CONTAIN LESS THAN 0.1% IRON, SULFUR & CHLORINE</p>	<p>BEST ON ALUMINUM</p>
<p>P PERFORMANCE LONG LIFE</p>	<p>CUT RATE: ●●●●○ LIFE: ●●●●●</p>	<p>TIGER AO Tiger wheels provide an even, sharp, clean cut and a hard bond extends wheel life.</p>	<p>GRAIN TYPE Aluminum oxide</p>	<p>BEST ON STEEL / METAL</p>
<p>V VALUE FAST CUT</p>	<p>CUT RATE: ●●●●○ LIFE: ●●●●○</p>	<p>WOLVERINE® Fast cut rate and consistent performance at a good value.</p>	<p>GRAIN TYPE Aluminum oxide</p>	<p>BEST ON STEEL / METAL</p>

Refer to ANSI B7.1 for storage & handling details

Key:

P PERFORMANCE LINE
Industrial Grade

V VALUE LINE
Professional Grade

All products meet ANSI B7.1

PRODUCT FEATURES

Weiler offers a small hub on 4-1/2" wheels to keep the wheel from gouging valuable parts as well as allowing for **30% more usable wheel area**



UltraCut true 1mm thickness delivers precise, consistent cuts on thin metal

Smooth outer layer reduces friction which translates to an effortless cut with less kickback



Small hub

Conventional hub size

Cut back provides instant aggressive grinding on new wheels



TYPE

Selecting the best wheel type for your application increases wheel effectiveness and user productivity.

CUTTING

Type 1
(Flat)



Flat profile allows for deep cuts

Type 27
(Depressed Center)



Added clearance when working at a constrained angle

GRINDING

Type 27
(Depressed Center)



Flat profile with depressed center allows for a wide range of grinding angles (0-45)

Type 28
(Depressed Center)



Designed for increased aggression at lower working angles and increased access

GRAIN / GRIT / GRADE

Selecting the best grain, grit and grade combination for your application can increase wheel effectiveness and user productivity. Use the charts below to help pick the right wheel for the job.

Grain

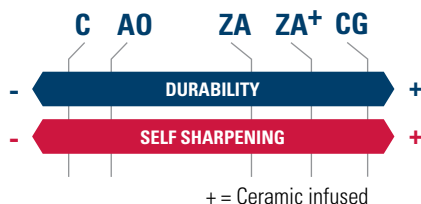

Grit

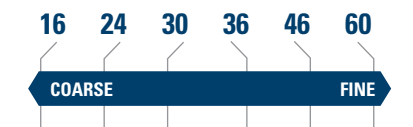

Hardness



APPLICATION

When selecting a wheel, always choose the thinnest wheel that will perform the cut while maintaining desired product life.

ULTRA THIN WHEEL
1mm

THIN WHEEL
.045"

THIN WHEEL
.060"

CUTTING WHEEL
3/32"

PIPELINE NOTCHING WHEEL
1/8"

COMBO WHEEL
1/8"

PIPELINE NOTCHING WHEEL
1/8"

GRINDING WHEEL
1/4"



Sheet metal, tubes, profiles and small cross-section rods

Tubes, bar stock and large cross-sections

Angle Iron, large cross-sections

Notching

Switching between cutting and grinding

For tough root pass notching & facing applications on the pipeline

Heavy stock removal, scale removal, weld removal, weld blending, edge beveling and torch-cut softening

WHY WEILER
BONDED ABRASIVES
COATED ABRASIVES
NON-WOVEN ABRASIVES
POWER BRUSHES
NYLON BRUSHES
PACKAGED ITEMS

CUTTING WHEELS



Cutting a piece of bar stock with an UltraCut wheel.

Weiler's diverse line of cutting wheels provide a consistent, well balanced, high quality solution. From our thin cutting wheels that slice through metal, to our large diameter wheels for the biggest cuts, professionals get the most demanding jobs done right and done fast.

FEATURES:

- **Ultracut 1mm** cutting wheels deliver lightning fast, super smooth, clean cuts on sheet metal, tubes, profiles, and small cross-section rods.
- **Smooth outer layer** on performance cutting wheels reduces friction that translates to an effortless cut and less kickback during operation.

TYPE 1 FOR GRINDERS



P HIGH PERFORMANCE THIN CUTTING

TYPE 1
7/8" Arbor

STEEL / METAL TIGER® ZIRC ULTRACUT 1MM / Fast Cut & Long Life

Diameter	Thickness	Grade	Max. RPM	Std. Pack	Item #
4-1/2"	1 mm	Z60T	13,300	50	58005
5"	1 mm	Z60T	12,200	50	58006

STAINLESS TIGER INOX ULTRACUT 1MM / Contaminant-free*

4-1/2"	1 mm	INOX60T	13,300	50	58130
5"	1 mm	INOX60T	12,200	50	58131

*Contaminant-free (Contains less than 0.1% Fe, S, Cl)

CUTS
20%
FASTER
than the closest
competitor

PROPRIETARY
SOLID
CORE
TECHNOLOGY

increases wheel density,
resulting in longer life,
reduced friction and
superior stability

A TRUE
1MM
THICKNESS

delivers precise, consistent
cuts you can count on



TRUE
1 MILLIMETER

STANDARD
.045"

TYPE 1 & 27 FOR GRINDERS

P MAX PERFORMANCE CUTTING

STEEL / METAL				TYPE 1 7/8" Arbor		TYPE 27 7/8" Arbor		TYPE 27 5/8"-11 Hub	
Diameter	Thickness	Grade	Max. RPM	Std. Pack	Item #	Std. Pack	Item #	Std. Pack	Item #
4-1/2"	.045"	CER60S	13,300	25	58300	25	58305	10	58306
5"	.045"	CER60S	12,200	25	58301	25	58307	10	58308
6"	.045"	CER60S	10,200	25	58302	25	58309	10	58310
7"	.060"	CER60S	8,500	25	58303	25	58311	10	58312



58300

P HIGH PERFORMANCE CUTTING

STEEL / METAL				TYPE 1 7/8" Arbor		TYPE 27 7/8" Arbor		TYPE 27 5/8"-11 Hub	
Diameter	Thickness	Grade	Max. RPM	Std. Pack	Item #	Std. Pack	Item #	Std. Pack	Item #
4-1/2"	.045"	Z60T	13,300	25	58000	25	58020	10	58030
5"	.045"	Z60T	12,200	25	58001	25	58021	10	58031
6"	.045"	Z60T	10,200	25	58002	25	58022	10	58032
7"	.060"	Z60T	8,500	25	58003	25	58023	10	58033

STAINLESS				TIGER INOX / Contaminant-free*					
Diameter	Thickness	Grade	Max. RPM	Std. Pack	Item #	Std. Pack	Item #	Std. Pack	Item #
4-1/2"	.045"	INOX60S	13,300	25	58100	25	58110	10	58109
5"	.045"	INOX60S	12,200	25	58101	25	58111	—	—
6"	.045"	INOX60S	10,200	25	58102	25	58112	10	58113
7"	.060"	INOX60S	8,500	25	58103	25	58107	—	—

ALUMINUM				TIGER ALUMINUM / Non-loading / Contaminant-free*					
Diameter	Thickness	Grade	Max. RPM	Std. Pack	Item #	Std. Pack	Item #	Std. Pack	Item #
4-1/2"	.045"	ALU60S	13,300	25	58200	25	58205	10	58206
5"	.045"	ALU60S	12,200	25	58201	25	58207	10	58208
6"	.045"	ALU60S	10,200	25	58202	25	58209	10	58210
7"	.060"	ALU60S	8,500	25	58203	25	58211	10	58212



58000



58110



58206

P PERFORMANCE CUTTING

STEEL / METAL				TYPE 1 7/8" Arbor		TYPE 27 7/8" Arbor		TYPE 27 5/8"-11 Hub	
Diameter	Thickness	Grade	Max. RPM	Std. Pack	Item #	Std. Pack	Item #	Std. Pack	Item #
4-1/2"	.045"	A60T	13,300	25	57020	25	57041	10	57040
	1/16"	A36T		25	57061	—	—	—	—
	3/32"	A36S		—	—	25	57081	10	57080
5"	.045"	A60T	12,200	25	57021	25	57043	10	57042
	3/32"	A36S		—	—	25	57083	10	57082
6"	.045"	A60T	10,200	25	57022	25	57045	10	57044
7"	.060"	A60T	8,500	25	57023	25	57046	10	57048
9"	1/16"	A60T	6,600	—	—	25	57047	10	57049 •



57040

• Non-stock product, contact Customer Service for lead times

V CUTTING

STEEL / METAL				TYPE 1 5/8" Arbor		TYPE 27 5/8" Arbor	
Dia.	Thickness	Grade	Max. RPM	Pack	Item #	Pack	Item #
4"	.035"	A60T	19,000	50	56271	—	—
4"	3/32"	A24T	15,200	—	—	25	56474
5"	.035"	A60T	12,200	100	56108	—	—



56474

V CUTTING

STEEL / METAL				TYPE 1 7/8" Arbor		TYPE 27 7/8" Arbor		TYPE 27 5/8"-11 Hub	
Diameter	Thickness	Grade	Max. RPM	Std. Pack	Item #	Std. Pack	Item #	Std. Pack	Item #
4-1/2"	.045"	A60T	13,300	50	56281	—	—	—	—
	.045"	A60S		—	—	25	56393	—	—
	1/16"	A60T		50	56103	—	—	—	—
	3/32"	A24T		—	—	25	56475	10	56385
5"	.045"	A60S	12,200	—	—	100	56392	—	—
	1/16"	A36T		100	56118	—	—	—	—
	3/32"	A24T		—	—	25	56476	10	56384
6"	.040"	A60T	10,200	25	56282	—	—	—	—
	.045"	A60T		25	56273	—	—	—	—
	.045"	A60S		—	—	25	56283	—	—
	3/32"	A24R		—	—	25	56277	10	56278
7"	.045"	A60T	8,500	25	56275	—	—	—	—
	.060"	A60S		—	—	25	56391	—	—
	3/32"	A24R		—	—	25	56383	10	56477
9"	1/8"	A24T	6,600	—	—	—	—	10	56423



56103

*Contaminant-free (Contains less than 0.1% Fe, S, Cl)

WHY WEILER

BONDED ABRASIVES

COATED ABRASIVES

NON-WOVEN ABRASIVES

POWER BRUSHES

NYLON BRUSHES

PACKAGED ITEMS

MAINTENANCE

TYPE 1 CUTTING WHEELS FOR DIE GRINDERS



P MAX PERFORMANCE CUTTING

STEEL / METAL TIGER® CERAMIC
STAINLESS Superior Life & Cut
HARD-TO-CUT Contaminant-free*

Dia.	Thickness	Grade	Max. RPM	TYPE 1 1/4" Arbor		TYPE 1 3/8" Arbor	
				Pack	Item #	Pack	Item #
3"	1/16"	CER36T	25,000	100	58345	100	58342
4"	1/16"	CER36T	19,000	25	58351	25	58348



P HIGH PERFORMANCE CUTTING

STEEL / METAL TIGER ZIRC / Fast Cut & Long Life

Dia.	Thickness	Grade	Max. RPM	TYPE 1 1/4" Arbor		TYPE 1 3/8" Arbor	
				Pack	Item #	Pack	Item #
3"	.035"	Z60T	25,000	100	58012	100	58011
4"	.035"	Z60T	19,000	25	58014	25	58013



P PERFORMANCE CUTTING

STEEL / METAL TIGER AO / Long Life

Dia.	Thickness	Grade	Max. RPM	TYPE 1 1/4" Arbor		TYPE 1 3/8" Arbor	
				Pack	Item #	Pack	Item #
2"	.035"	A60T	30,000	100	57014	100	57010
	1/16"	A36T			57015		57011
	1/8"	A36T			57016		57012
3"	.035"	A60T	25,000	100	57065	100	57001
	1/16"	A36T			57066		57060
	1/8"	A36T			57068		57063
4"	.035"	A60T	19,000	25	57075	25	57070
	1/16"	A36T			57076		57071
	1/8"	A36T			57077		57072



V VALUE CUTTING

STEEL / METAL WOLVERINE® AO / Fast Cut

Dia.	Thickness	Grade	Max. RPM	TYPE 1 1/4" Arbor		TYPE 1 3/8" Arbor	
				Pack	Item #	Pack	Item #
2"	.035"	A60T	30,000	100	56013	100	56128
	1/16"	A36T			50		56129
	1/8"	A36S			50		56130
3"	.035"	A60T	25,000	100	56061	100	56062
	1/16"	A36T		100	56065	100	56068
	1/16"	A60T		-	-	100	56070
	1/8"	A36T		-	-	50	56076
	1/8"	A36S		-	-	50	56060
4"	.035"	A60T	19,000	50	56165	50	56080
	1/16"	A36T		50	56166	50	56086
	1/8"	A36T		-	-	50	56099
	1/8"	A36S		50	56167	-	-

ACCESSORIES



ADAPTING NUTS & SPANNER WRENCH For 4-1/2" - 9" Angle Grinders.

Description	Adapts To	Min. Wheel Thickness	Standard Pack	Item Number
Adapting Nuts	5/8" to 3/8"-24	1/16"	1	56484
Adapting Nuts	7/8" to 5/8"-11	1/16"	1	56494
Spanner Wrench	-	-	1	56495

56495



MOUNTING MANDRELS 1/4" Stem. For Type 1 Wheels Only.

Arbor Size	Wheel Thickness	Standard Pack	Item Number
1/4"	.035" to 1/4"	10	56489
3/8"	.035" to 1/4"	10	56490
1/4", 3/8" *	.035" to 1/4"	10	56491*

*Combination pack



ADAPTER for mounting Large Cutting Wheels onto a 20mm arbor.

For Arbor Hole Size	Adapted Arbor Hole Size	Standard Pack	Item Number
1"	20mm	10	04455

TYPE 1 SNAGGING WHEELS FOR DIE GRINDERS

P PERFORMANCE SNAGGING

STEEL / METAL **TIGER® AO** / Long Life

Dia.	Thickness	Grade	Max. RPM	TYPE 1 1/4" Arbor		TYPE 1 3/8" Arbor	
				Pack	Item #	Pack	Item #
3"	1/4"	A24T	25,000	40	57069	40	57064
4"	1/4"	A24T	15,300	10	57078	10	57073

V VALUE SNAGGING

STEEL / METAL **WOLVERINE® AO** / Fast Cutting

Dia.	Thickness	Grade	Max. RPM	TYPE 1 3/8" Arbor	
				Pack	Item #
2"	1/4"	A60T	30,000	25	56131
3"	1/4"	A24T	25,000	25	56064
4"	1/4"	A36T	15,300	25	56163

TYPE 27 SNAGGING WHEELS FOR DIE GRINDERS

P PERFORMANCE SNAGGING

STEEL / METAL **TIGER AO** / Long Life

Dia.	Thickness	Grade	Max. RPM	TYPE 27 3/8" Arbor	
				Pack	Item #
4"	1/4"	A24T	15,300	10	57074



57064



56064



57074

TYPE 1 FOR CHOP SAWS / STATIONARY SAWS



P PERFORMANCE LARGE CUTTING

STEEL / METAL **TIGER AO** / Long Life

For Stationary Saws					
Diameter	Thickness	Grade	Max. RPM	Std. Pack	Item #
12"	3/32"	A36T	5,100	25	57090
14"	1/8"	A30R	4,400	10	57091*
	3/32"	A36T			57092
		A36R			57093 ◆

*Recommended for stationary saws only.

◆ Softer bond for smoother, faster cutting.



57090

V LARGE CUTTING

STEEL / METAL **WOLVERINE AO** / Fast Cutting

Dia.	Thickness	Grade	Max. RPM	Std. Pack	Item #
12"	3/32"	A46T	5,100	25	56239
14"	3/32"	A46T	4,400	10	56240
For Stationary Saws					
14"	1/8"	A30R	4,400	10	56230



56239

WHY WEILER

BONDED ABRASIVES

COATED ABRASIVES

NON-WOVEN ABRASIVES

GRINDING WHEELS 0-45°



Grinding on a platform for weld preparation.

Weiler's high quality line of grinding wheels help Metal Fabrication professionals get the most demanding jobs done right, and done fast.

FEATURES:

- Tiger type 27 grinding wheels are designed with fiberglass **cut back** from the edge to provide instant aggressive grinding on new wheels.
- Type 28 grinding wheels are designed for increased aggression at **lower working angles** and increased access to the work piece.

TYPE 27 FOR GRINDERS



58326

P MAX PERFORMANCE GRINDING

STEEL / METAL TIGER® CERAMIC / Superior Life & Cut Contaminant-free*
STAINLESS
HARD-TO-GRIND

Dia.	Thickness	Grade	Max. RPM	TYPE 27 5/8" Arbor		TYPE 27 7/8" Arbor		TYPE 27 5/8"-11 Hub	
				Std. Pack	Item #	Std. Pack	Item #	Std. Pack	Item #
4"	1/4"	CER24R	15,300	10	58335	—	—	—	—
4-1/2"	1/4"	CER24R	13,300	—	—	10	58325	10	58326
5"	1/4"	CER24R	12,200	—	—	10	58327	10	58328
6"	1/4"	CER24R	10,200	—	—	10	58329	10	58330
7"	1/4"	CER24R	8,500	—	—	10	58331	10	58332
9"	1/4"	CER24R	6,600	—	—	10	58333	10	58334



58079

P HIGH PERFORMANCE GRINDING

STEEL / METAL TIGER ZIRC / Ceramic-infused Fast Cut & Long Life

Dia.	Thickness	Grade	Max. RPM	TYPE 27 5/8" Arbor		TYPE 27 7/8" Arbor		TYPE 27 5/8"-11 Hub	
				Std. Pack	Item #	Std. Pack	Item #	Std. Pack	Item #
4"	1/4"	Z24T	15,300	10	58069	—	—	—	—
4-1/2"	1/4"	Z24T	13,300	—	—	10	58071	10	58070
5"	1/4"	Z24T	12,200	—	—	10	58073	10	58072
6"	1/4"	Z24T	10,200	—	—	10	58079	10	58078
7"	1/4"	Z24T	8,500	—	—	10	58075	10	58074
9"	1/4"	Z24T	6,600	—	—	10	58077	10	58076



58120

STAINLESS TIGER INOX / Contaminant-free*

4-1/2"	1/4"	INOX24R	13,300	—	—	10	58121	10	58120
5"	1/4"	INOX24R	12,200	—	—	10	58123	10	58122
6"	1/4"	INOX24R	10,200	—	—	10	58129	10	58128
7"	1/4"	INOX24R	8,500	—	—	10	58125	10	58124
9"	1/4"	INOX24R	6,600	—	—	10	58127	10	58126



58225

ALUMINUM TIGER ALUMINUM / Non-loading / Contaminant-free*

4-1/2"	1/4"	ALU24R	13,300	—	—	10	58225	10	58226
5"	1/4"	ALU24R	12,200	—	—	10	58227	10	58228
6"	1/4"	ALU24R	10,200	—	—	10	58229	10	58230
7"	1/4"	ALU24R	8,500	—	—	10	58231	10	58232
9"	1/4"	ALU24R	6,600	—	—	10	58233	10	58234



57120

P PERFORMANCE GRINDING

STEEL / METAL TIGER AO / Long Life

Dia.	Thickness	Grade	Max. RPM	TYPE 27 5/8" Arbor		TYPE 27 7/8" Arbor		TYPE 27 5/8"-11 Hub	
				Std. Pack	Item #	Std. Pack	Item #	Std. Pack	Item #
4"	1/4"	A24R	15,300	10	57119	—	—	—	—
4-1/2"	1/4"	A24R	13,300	—	—	10	57121	10	57120
5"	1/4"	A24R	12,200	—	—	10	57123	10	57122
6"	1/4"	A24R	10,200	—	—	10	57129	10	57128
7"	1/4"	A24R	8,500	—	—	10	57125	10	57124
9"	1/4"	A24R	6,600	—	—	10	57127	10	57126

*Contaminant-free (Contains less than 0.1% Fe, S, Cl)

V GRINDING

STEEL / METAL **WOLVERINE® AO** / Fast Cutting

Diameter	Thickness	Grade	Max. RPM	TYPE 27 5/8" Arbor		TYPE 27 7/8" Arbor		TYPE 27 5/8" Arbor	
				Std. Pack	Item #	Std. Pack	Item #	Std. Pack	Item #
4"	1/4"	A24R	15,200	25	56473	—	—	—	—
4-1/2"	1/4"	A24R	13,300	—	—	25	56464	10	56454
4-1/2"	1/4"	A24N	13,300	—	—	25	56457	10	56455
5"	1/4"	A24R	12,200	—	—	25	56466	10	56449
6"	1/4"	A24R	10,200	—	—	25	56280	10	56279
7"	1/4"	A24R	8,500	—	—	25	56467	10	56468
9"	1/4"	A24R	6,600	—	—	—	—	10	56470



56473

TYPE 28 FOR GRINDERS

P HIGH PERFORMANCE GRINDING

STEEL / METAL **TIGER® ZIRC** / Ceramic-infused
Fast Cut & Long Life

Diameter	Thickness	Grade	Max. RPM	TYPE 28 7/8" Arbor		TYPE 28 5/8"-11 Hub	
				Std. Pack	Item #	Std. Pack	Item #
7"	1/4"	Z24T	8,500	10	58081	10	58080
9"	1/4"	Z24T	6,600	10	58083	10	58082

58081



P PERFORMANCE GRINDING

STEEL / METAL **TIGER AO** / Long Life

Diameter	Thickness	Grade	Max. RPM	TYPE 28 7/8" Arbor		TYPE 28 5/8"-11 Hub	
				Std. Pack	Item #	Std. Pack	Item #
7"	1/4"	A24R	8,500	10	57135	10	57134
9"	1/4"	A24R	6,600	10	57137	10	57136

57134



WHY WEILER

BONDED ABRASIVES

COATED ABRASIVES

NON-WOVEN ABRASIVES

POWER BRUSHES



"The Tiger grinds real well, it's sharp, it grabs, and feels good."

- Brandon G., Oil Rig Welder, Texas

COMBO WHEELS



Weld removal with Tiger combo wheel.

Weiler's Combination Wheels offer flexibility and efficiency when switching between cutting and grinding applications. Our **Tiger reinforcement technology** provides the strength to hold up when grinding, while maintaining a fast cut.

TYPE 27 FOR GRINDERS

P MAX PERFORMANCE CUT / GRIND COMBO

STEEL / METAL TIGER® CERAMIC
STAINLESS Superior Life & Cut
HARD-TO-GRIND Contaminant-free*

TYPE 27
7/8" Arbor

TYPE 27
5/8"-11 Hub

Diameter	Thickness	Grade	Max. RPM	Std. Pack	Item #	Std. Pack	Item #
4-1/2"	1/8"	CER30T	13,300	25	58315	10	58316
5"	1/8"	CER30T	12,200	25	58317	10	58318
6"	1/8"	CER30T	10,200	25	58319	10	58320
7"	1/8"	CER30T	8,500	25	58321	10	58322
9"	1/8"	CER30T	6,600	25	58323	10	58324



58315



58054

P HIGH PERFORMANCE CUT / GRIND COMBO

STEEL / METAL TIGER ZIRC / Fast Cut & Long Life

TYPE 27
7/8" Arbor

TYPE 27
5/8"-11 Hub

Diameter	Thickness	Grade	Max. RPM	Std. Pack	Item #	Std. Pack	Item #
4-1/2"	1/8"	Z30T	13,300	25	58051	10	58050
5"	1/8"	Z30T	12,200	25	58053	10	58052
6"	1/8"	Z30T	10,200	25	58064	10	58054
7"	1/8"	Z30T	8,500	25	58056	10	58055
9"	1/8"	Z30T	6,600	25	58058	10	58057

STAINLESS TIGER INOX / Contaminant-free*

4-1/2"	1/8"	INOX30T	13,300	25	58115	10	58114
7"	1/8"	INOX30T	8,500	25	58117	10	58116
9"	1/8"	INOX30T	6,600	25	58119	10	58118

ALUMINUM TIGER ALUMINUM / Non-loading / Contaminant-free*

4-1/2"	1/8"	ALU30T	13,300	25	58215	10	58216
5"	1/8"	ALU30T	12,200	25	58217	10	58218
6"	1/8"	ALU30T	10,200	25	58219	10	58220
7"	1/8"	ALU30T	8,500	25	58221	10	58222

P PERFORMANCE CUT / GRIND COMBO

STEEL / METAL TIGER AO / Long Life

TYPE 27
7/8" Arbor

TYPE 27
5/8"-11 Hub

Diameter	Thickness	Grade	Max. RPM	Std. Pack	Item #	Std. Pack	Item #
4-1/2"	1/8"	A30S	13,300	25	57101	10	57100
5"	1/8"	A30S	12,200	25	57103	10	57102
6"	1/8"	A30S	10,200	25	57109	10	57108
7"	1/8"	A30S	8,500	25	57105	10	57104
9"	1/8"	A30S	6,600	25	57107	10	57106



58114



58215



57100

V CUT / GRIND COMBO

STEEL / METAL WOLVERINE® AO / Fast Cutting

TYPE 27
7/8" Arbor

TYPE 27
5/8" Arbor

Diameter	Thickness	Grade	Max. RPM	Std. Pack	Item #	Std. Pack	Item #
4-1/2"	1/8"	A24T	13,300	25	56430	10	56429
5"	1/8"	A24T	12,200	25	56428	10	56427
7"	1/8"	A24T	8,500	25	56426	10	56425



56425

*Contaminant-free (Contains less than 0.1% Fe, S, Cl)

PIPELINE WHEELS

TYPE 27 FOR PIPELINE

Fast grinding and long life on the line and in the fab yard.

NEW: Weiler's Pipeliner Grinding Wheels are designed specifically for pipeline applications. Whether grinding a bead, facing the land, prepping transitions, or fabricating in the yard, this wheel is ready to work out of the box, delivering consistent, aggressive grinding throughout the life of the wheel, eliminating the need to chip it.

FEATURES & BENEFITS:

Do NOT Chip

(Operators will no longer feel the need to chip the wheel to get it to bite.)

Reduced Chatter

Superior Cut & Life

One Wheel for

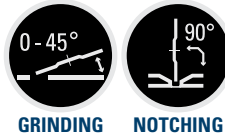

GRINDING

NOTCHING

NEW



58090



58094



P HIGH PERFORMANCE PIPELINER GRINDING WHEELS

STEEL / METAL TIGER® ZIRC / Ceramic-infused / Fast Grinding & Long Life on Pipe

Diameter	Thickness	Grade	Max. RPM	Std. Pack	Item #
4-1/2"	1/8"	Z30T	13,300	10	58090
6"	1/8"	Z30T	10,200	10	58092
7"	1/8"	Z30T	8,500	10	58094
9"	1/8"	Z30T	6,600	10	58095

TYPE 27
5/8"-11 Arbor

TYPE 27 FOR MECHANIZED PIPE WELDING

NEW: Weiler's Tiger Mech Wheels are designed for notching applications on mechanical pipe welds. These high-performance wheels are thinner than standard pipe notching wheels, allowing the operator to grind the bead without widening or scarring the bevel.

FEATURES & BENEFITS:

Designed to Fit

Tiger Mech reaches the bead without widening the bevel

Optimized Performance

Designed specifically to grind starts and stops on J and K bevels

Superior Cut & Life

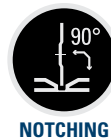

NOTCHING

NEW



58066



58067

P HIGH PERFORMANCE MECH NOTCHING WHEELS

STEEL / METAL TIGER ZIRC / Ceramic-infused / Notching Mechanized Pipe Welds

Diameter	Thickness	Grade	Max. RPM	Std. Pack	Item #
4-1/2"	3/32"+	Z30T	13,300	10	58066
5"	3/32"+	Z30T	12,200	10	58067
7"	3/32"+	Z30T	8,500	10	58068

TYPE 27
5/8"-11 Arbor

+ Specific size for mechanized pipe welds

**RISE'N
GRIND**
TM





*Claudia
Class of 2019*

LEADING A WARRIORS CHARGE



Rebuilding American Manufacturing One Veteran At A Time.™

Weiler Abrasives is proud to support Workshops for Warriors®, an organization that provides veterans and transitioning services members with training and certification for careers in welding, machining and fabrication at no cost to the veteran.

With the support of Weiler Abrasives and others, Workshops for Warriors will be able to increase its impact by expanding the current facility to accommodate an additional 450 students per year. The new facility will be a center for advanced manufacturing training and a place where veterans like Claudia can successfully transition into civilian life.

SUPPORT THE CAUSE: weilerabrasives.com



Celebrating 75 years of growth, innovation, and partnership with our customers, co-workers, and community.





WEILER WAS FIRST

From the company that brought flap discs to the US, Weiler coated abrasive products continue to set the standard. Our Premium Tiger® flap discs are engineered to conquer any material or application.

Weiler recently expanded it's Resin Fiber Disc line to deliver serious grinding solutions. Weiler Tiger and Wolverine RFDs are designed to help users optimize grinding time on a wide variety of applications.

Technical Information	24-27
Flap Discs	28-33
Resin Fiber Discs	34-37
Blending Discs	38
Trim-Kut® Discs	39
Flap Wheels	40-41
Shop Rolls	42

COATED ABRASIVES

SOLUTIONS SHOWCASE

STEEL PIPING

Problem: A clean bevel end free of any surface imperfections is critical to a strong joint when welding heavy-wall piping. Unfortunately, lengths of steel pipe can sit in yards for significant periods of time, and pitting of the bevel ends is usually the result.

Solution: Coated abrasive flap discs like Weiler's original Tiger Disc are ideal tools for quickly removing heavy corrosion and blending pitting from bevel ends. The chatter-free, compliant grinding action and smooth, consistent finish produced by these discs make them the preferred choice for this application.



STEEL CHANNEL

Problem: Burrs produced by cut-off operations are dangerous and can prevent parts from fitting together properly, which can cause potential structural weak points.

Solution: Weiler's coated abrasive flap wheels are flexible grinding products that are ideal for light stock removal applications. A 60 grit wheel can be used to remove a large burr and produce a smooth blended edge.



ALUMINUM FRAMES

Problem: Aluminum welds are particularly difficult to blend due to the tendency of the chips to become welded to the abrasive media. This causes the cut rate of the abrasive to fall rapidly and generates an expensive grinding operation.

Solution: Weiler's AL-tra Cut™ discs are specially formulated to prevent loading by lowering the grinding temperature. A 60 grit AL-tra Cut disc can blend an aluminum weld bead much faster than a conventional disc without loading.





STRUCTURAL STEEL BEAM

Problem: Grinding fillet welds is a difficult, time-consuming process that is often expensive to perform.

Solution: Tiger Angled flap discs are a great option for the metalworking professional looking for more versatility than a traditional flap disc can offer and ready to go to work right out of the box. They are ideal for applications that previously required either a carbide burr or trimmable flap disc in order to access welds. Tiger Angled also provides versatility in repair and re-work applications, where it is important to focus grinding in a small area while minimizing impact to the surrounding work piece(s).

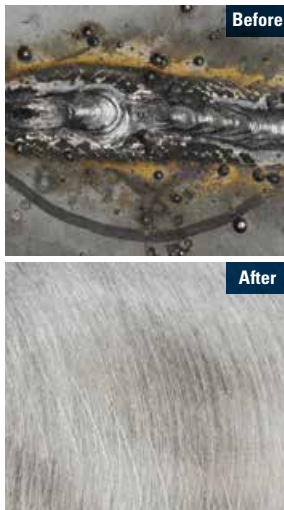

TANK AND PRESSURE VESSEL

Problem: The welds inside tanks and pressure vessels must be blended smooth prior to x-ray and pressure testing.

Solution: Weiler's Big Cat® High Density flap discs have the largest cloth area in the industry – 22% more cloth. The result is enhanced conformability on curved or irregular surfaces and up to 40% longer life.



STEEL RACK BRACES

Problem: To prevent weldments used in the construction of offshore oil platforms from "racking" under load, lengths of steel bar stock are added as braces during the fabrication of these structural members. Beveling or chamfering the ends of the bars increases weld penetration and strengthens the joint.

Solution: The requirement for fast stock removal and long wheel life makes this an ideal application for a good quality Type 27 grinding wheel like those in Weiler's Vortec Pro® line of general-purpose bonded abrasives.

SELECTING THE RIGHT FLAP DISC

Weiler's abrasive flap discs grind and finish in one step, saving you time and money. There's no switching from a type 27 grinding wheel to a resin fiber disc.







P MAX PERFORMANCE	TIGER® CERAMIC <ul style="list-style-type: none"> • TOP COAT for cool grinding • Protects from heat discoloration • Prevents loading on soft alloys 	GRAIN TYPE Ceramic alumina CONTAMINANT FREE CONTAIN LESS THAN 0.1% IRON, SULFUR & CHLORINE	STYLES  	BEST ON STEEL / METAL ALUMINUM STAINLESS HARD-TO-GRIND (Hard-to-grind metals include tool steel, inconel, high nickel alloy, titanium and armored steel)
P HIGH PERFORMANCE	TIGER X <ul style="list-style-type: none"> • FLAT SURFACE GRINDING • Less effort required • Fast grinding & long life 	GRAIN TYPE Ceramic & zirconia alumina CONTAMINANT FREE CONTAIN LESS THAN 0.1% IRON, SULFUR & CHLORINE	STYLES    *Big Cat	BEST ON STEEL / METAL STAINLESS (Metal includes structural steel and cast iron)
P PERFORMANCE	TIGER PAW <ul style="list-style-type: none"> • SUPERIOR EDGE GRINDING • Aggressive stock removal 	GRAIN TYPE 100% zirconia alumina CONTAMINANT FREE CONTAIN LESS THAN 0.1% IRON, SULFUR & CHLORINE	STYLES   	BEST ON STEEL / METAL STAINLESS (Metal includes structural steel and cast iron)
V VALUE	WOLVERINE® <ul style="list-style-type: none"> • Fast stock removal • Consistent performance 	GRAIN TYPE Zirconia alumina	STYLES   	BEST ON STEEL / METAL

*Big Cat is a zirconia alumina flap disc and does not contain any ceramic alumina.

SPECIALTY FLAP DISCS



		MAX PERFORMANCE	HIGH PERFORMANCE	PERFORMANCE	VALUE
ANGLED (Fillet Welds) 		✓	✓		
TRIMMABLE (Non-Marking) 		✓	✓		
ALUMINUM BACK (Rigid Support) 			✓		✓
MINI (Tight Spaces) 				✓ (Bobcat)	

Refer to ANSI B7.1 for storage & handling details

KEY: ✓ PERFORMANCE LINE ✓ VALUE LINE

All products meet ANSI B7.1

STYLE



CONICAL (Type 29)
15° – 35°



Angled flaps maximize surface contact for aggressive stock removal on flat surfaces.



FLAT (Type 27)
0° – 15°



Smooth grinding, blending and finishing on flat surfaces and slight contours.



HIGH DENSITY (Type 27)
0° – 15°



Conformable to irregular surfaces. Smooth grinding, blending and finishing on flat surfaces.



ANGLED (Type 27 / Hybrid)
0° – 35°

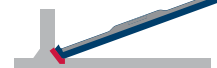

Curved flaps for grinding fillet welds, T-joints and hard-to-reach areas.

GRIT

Coarse Grit

36

40

60

80

Fine Grit

120

HEAVY STOCK REMOVAL

EDGE BEVELING / CHAMFERING

WELD GRINDING / BLENDING

DEBURR / DEFLASH

RUST REMOVAL / BLENDING

CLEANING / FINISHING

GRAIN



CERAMIC ALUMINA (CA)

- Self-sharpening micro fracturing crystals expose sharp edges
- Maintains a high cut-rate for the life of the grain
- Longest cutting life under moderate to high pressure
- Exceptional performance on hard-to-grind metals



ZIRCONIA ALUMINA (ZA)

- Self-sharpening crystals
- Holds up under high temperatures and extreme pressure
- Sharp, fast cutting, long lasting grain



ALUMINUM OXIDE (AO)

- Single crystal that dulls during use
- Good initial cut rate
- Hard, durable grain

BACKING

PHENOLIC



Prevents backing from scratching the workpiece.

ALUMINUM



Rigid support for maximum aggression; recyclable.

COMPOSITE*



Trimmable, non-marking backing; allows access to hard-to-reach areas.

*BobCat™ Discs are not Trimmable.

ARBOR

5/8" - 11 NUT

- Quick change over
- Eliminates cross-threading experienced with plastic backs
- Metal nut eliminates the disc from sticking to the grinder due to heat build up



OPEN ARBOR

- Requires adapting nuts
- 5/8" option for 4" grinders
- 7/8" option for 4-1/2" and larger grinders



MOUNTING DISCS WITH OPEN ARBORS



- Adapting Nut
- Abrasive Flap Disc
- Adapting Nut
- Right Angle Grinder

MANDRELS & METAL HUB PADS

- For quick-change on tools with 1/4" collets



- Type R hub pad + mandrel
- Type S hub pad + mandrel
- Type S mandrel

STANDARD DENSITY FLAP DISCS



Grinding & blending a weld between two Steel plates.



MADE IN
USA
WITH GLOBAL
MATERIALS

Weiler's Tiger discs are engineered to maximize productivity and minimize operating costs for professionals who demand more. Get the right flap disc for your application and **get more done with Tiger.**



P MAX PERFORMANCE / TIGER® CERAMIC (SABER TOOTH)

Top Coated for Cool Grinding / Ceramic Alumina / Phenolic Back

STEEL / METAL		STAINLESS		HARD-TO-GRIND		ALUMINUM		TYPE 29 7/8" Arbor		TYPE 29 5/8"-11 Hub	
Diameter	Grit	Max. RPM	Std. Pack	Item #	Item #	Item #	Item #	Item #	Item #	Item #	Item #
4-1/2"	36	13,000	10	50100	50104*						
	40			50101	50105*						
	60			50102	50106*						
	80			50103	50107*						
5"	40	12,000	10	50538 •	—						
	60			50539 •	—						
	80			50540 •	—						
	36			50108	50112*						
7"	40	8,600	10	50109	50113*						
	60			50110	50114*						
	80			50111	50115*						

• Non-stock product, contact Customer Service for lead times



P HIGH PERFORMANCE / TIGER X

Fast Grinding & Long Life on Flat Surfaces / Ceramic & Zirconia Alumina / Phenolic Back

STEEL / METAL		STAINLESS		TYPE 29 7/8" Arbor		TYPE 29 5/8"-11 Hub		TYPE 27 7/8" Arbor		TYPE 27 5/8"-11 Hub	
Diameter	Grit	Max. RPM	Std. Pack	Item #	Item #	Item #	Item #	Item #	Item #	Item #	Item #
4-1/2"	36	13,000	10	51200	51204*	—	—	—	—	—	—
	40			51201	51205*	51223	51226*	—	—		
	60			51202	51206*	51224	51227*	—	—		
	80			51203	51207*	51225	51228*	—	—		
5"	36	12,000	10	51208	—	—	—	—	—	—	—
	40			51209	51212*	—	—	—	—		
	60			51210	51213*	—	—	—	—		
	80			51211	51214*	—	—	—	—		
7"	36	8,600	10	51215	51219*	—	—	—	—	—	—
	40			51216	51220*	51229	51232*	—	—		
	60			51217	51221*	51230	51233*	—	—		
	80			51218	51222*	51231	51234*	—	—		



Industry First
X3
Technology

grain anchoring system, dual flap design, and engineered backing.



Ceramic Alumina and Zirconia Alumina grain mix
Grinds Faster and Lasts Longer.

P PERFORMANCE / ORIGINAL TIGER®

High cut rate & long life / Zirconia Alumina / Phenolic Back

STEEL / METAL	STAINLESS		TYPE 29	TYPE 29	TYPE 29	TYPE 27	TYPE 27	TYPE 27	
	Max. RPM	Std. Pack	5/8" Arbor	7/8" Arbor	5/8"-11 Hub	5/8" Arbor	7/8" Arbor	5/8"-11 Hub	
4"	36	15,000	10	50592	—	—	—	—	
	40			50593	—	—	50693	—	
	60			50594	—	—	50694	—	
	80			50595	—	—	50695	—	
	120			—	—	—	50696	—	
4-1/2"	24	13,000	10	—	50601	—	—	—	
	120			—	50606	—	—	50706	50699*
5"	40	12,000	10	—	—	—	—	—	
	60			—	—	—	50713	—	
	80			—	—	—	50714	—	
	120			—	50616	—	—	50715	—
	—			—	—	—	—	—	—
6"	40	10,200	10	—	50649	50659	—	—	
	60			—	50650	—	—	—	
	80			—	50651	50660	—	—	
7"	120	8,600	10	—	—	—	—	—	
	—			—	—	—	—	—	
	—			—	—	—	—	—	50746* •

• Non-stock product, contact Customer Service for lead times



50601



51126



51140

P PERFORMANCE / TIGER PAW

Aggressive Stock Removal for Edge Grinding / 100% Zirconia Alumina / Phenolic Back

STEEL / METAL	STAINLESS		TYPE 29	TYPE 29	TYPE 29	TYPE 27	TYPE 27	TYPE 27	
	Max. RPM	Std. Pack	5/8" Arbor	7/8" Arbor	5/8"-11 Hub	5/8" Arbor	7/8" Arbor	5/8"-11 Hub	
4"	40	15,000	10	51104	—	—	51101	—	
	60			51105	—	—	51102	—	
4-1/2"	36	13,000	10	—	51118	51123*	—	51107	
	40			—	51119	51124*	—	51108	51112*
	60			—	51120	51125*	—	51109	51113*
	80			—	51121	51126*	—	51110	51114*
5"	36	12,000	10	—	51128	51153*	—	51182	
	40			—	51129	51132*	—	51183	51155*
	60			—	51130	51133*	—	51135	51156*
	80			—	51131	51154*	—	51183	51157*
7"	36	8,600	10	—	—	51149*	—	—	
	40			—	51145	51146*	—	51137	51139*
	60			—	51150	51147*	—	51138	51140*
	80			—	—	51148*	—	—	51142*

51140

V WOLVERINE®

Consistent Performance / Zirconia Alumina / Phenolic Back

STEEL / METAL	STAINLESS		TYPE 29	TYPE 29	TYPE 29	TYPE 27	TYPE 27	
	Max. RPM	Std. Pack	5/8" Arbor	7/8" Arbor	5/8"-11 Hub	7/8" Arbor	5/8"-11 Hub	
4"	36	15,000	10	31337	—	—	—	—
	40			31338	—	—	—	—
	60			31339	—	—	—	—
	80			31340	—	—	—	—
4-1/2"	36	13,000	10	—	31343	31349*	31401	31407*
	40			—	31344	31350*	31402	31408*
	60			—	31345	31351*	31403	31409*
	80			—	31346	31352*	31404	31410*
	120			—	31347	31353*	—	—
5"	36	12,000	10	—	31355	—	—	—
	40			—	31356	—	—	—
	60			—	31357	—	—	—
	80			—	31358	—	—	—
7"	36	8,600	10	—	31361	31367*	—	31419*
	40			—	31362	31368*	31414	31420*
	60			—	31363	31369*	31415	31421*
	80			—	31364	31370*	—	31422*



31338



31343

Key:

P PERFORMANCE LINE Industrial Grade

V VALUE LINE Professional Grade

*Patent # 6,945,863

WHY WEILER
BONDED ABRASIVES

COATED ABRASIVES

NON-WOVEN ABRASIVES

POWER BRUSHES

NYLON BRUSHES

PACKAGED ITEMS

MAINTENANCE

HIGH DENSITY FLAP DISCS



MADE IN
USA
WITH GLOBAL
MATERIALS

High density flap discs last up to 40% longer than standard density. They are ideal for grinding and blending uneven or irregular surfaces.



Blending and finishing a weld with a Big Cat flap disc.



INDUSTRY-LEADING FOOTPRINT

30mm flaps on Big Cat and Tiger Paw increases surface area grinding



50134

P MAX PERFORMANCE / TIGER® CERAMIC HD (SABER TOOTH)

Top Coated for Cool Grinding on Irregular Surfaces / Ceramic Alumina / Phenolic Back

STEEL / METAL STAINLESS HARD-TO-GRIND ALUMINIUM

Diameter	Grit	Max. RPM	Std. Pack	TYPE 27	
				7/8" Arbor	5/8"-11 Hub
4-1/2"	40	13,000	10	Item #	Item #
	60			50130	50133*
	80			50131	50134*
7"	40	8,600	10	50132	50135*
	60			50136	50139*
	80			50137	50140*
				50138	50141*



50804

P HIGH PERFORMANCE / TIGER BIG CAT® HD

Fast Grinding & Long Life on Irregular Surfaces / Zirconia Alumina / Phenolic Back

STEEL / METAL STAINLESS

Diameter	Grit	Max. RPM	Std. Pack	TYPE 27	
				7/8" Arbor	5/8"-11 Hub
4-1/2"	40	13,000	10	Item #	Item #
	60			50803	50808*
	80			50804	50809*
	120			50805	50810*
7"	40	8,600	10	50806	—
	60			50823	50843*
	80			50824	50844*
	120			50825	50845*
				—	50846*



51165

P PERFORMANCE / TIGER PAW™ HD

Aggressive Stock Removal on Irregular Surfaces / 100% Zirconia Alumina / Phenolic Back

STEEL / METAL STAINLESS

Diameter	Grit	Max. RPM	Std. Pack	TYPE 27	
				7/8" Arbor	5/8"-11 Hub
4-1/2"	36	13,000	10	Item #	Item #
	40			51160	51164*
	60			51161	51165*
	80			51162	51166*
7"	40	8,600	10	51163	51167*
	60			51170	51168*
				51171	51169*



31388

V WOLVERINE® HD

Consistent Performance on Irregular Surfaces / Zirconia Alumina / Phenolic Back

STEEL / METAL

Diameter	Grit	Max. RPM	Std. Pack	TYPE 27	
				7/8" Arbor	5/8"-11 Hub
4-1/2"	40	13,000	10	Item #	Item #
	60			31387	31390*
	80			31388	31391*
				31389	31392*

SPECIALTY FLAP DISCS



ALUMINUM BACK

Aluminum backed flap discs are ideal for demanding applications that require extra strength and rigid support. The aluminum backing plate is also 100% recyclable.

MADE IN
USA
WITH GLOBAL
MATERIALS



Blending fillet welds to ensure proper penetration prior to inspection.

P HIGH PERFORMANCE / **TIGER® ALUMINUM BACK**

Fast Grinding & Long Life / Zirconia Alumina / Backing Plate Provides Rigid Support

STEEL / METAL	STAINLESS	Max. RPM	Std. Pack	TYPE 29	TYPE 29	TYPE 29
				5/8" Arbor	7/8" Arbor	5/8"-11 Hub
Diameter	Grit			Item #	Item #	Item #
4"	36	15,000	10	50502	-	-
	40			50503	-	-
	60			50504	-	-
	80			50505	-	-
	120			50506	-	-
4-1/2"	24	13,000	10	-	50511	50510
	36			-	50512	50517
	40			-	50513	50518
	60			-	50514	50519
	80			-	50515	50520
5"	120	-	-	50516	50509	-
	36	12,000	10	-	50522	-
	40			-	50523	-
	60			-	50524	-
	80			-	50525	-
120	-			50526	-	
7"	24	8,600	10	-	-	50541
	36			-	50532 •	50542
	40			-	50533 •	50543
	60			-	50534 •	50544
	80			-	-	50545
	120			-	-	50546

• Non-stock product, contact Customer Service for lead times



"Weiler products are very rugged consumables. They have a long life."

- **Dave Porzuczek**, Assistant Foreman, Karnel Incorporated

Key:

P PERFORMANCE LINE Industrial Grade **V** VALUE LINE Professional Grade

S NYLOX BRUSHES
PACKAGED ITEMS
MAINTENANCE

ANGLED DISCS

The 90° angled flap design is ideal for grinding fillet welds, T-joints and other hard-to-reach places. The flaps wrap around the edge of the backing plate, optimizing flap-to-metal contact and providing exceptional feel and control while grinding.



Angled flaps are ideal for fillet welds and hard-to-reach places



51313

P MAX PERFORMANCE / TIGER® CERAMIC ANGLED

Top Coated for Cool Grinding on Fillet Welds / Ceramic Alumina / Phenolic Back

Diameter	Grit	Max. RPM	Std. Pack	Type 29	
				7/8" Arbor	5/8"-11 Hub
4-1/2"	40	13,000	10	Item #	Item #
	60			51312	51315
	80			51313	51316
5"	40	12,000	10	51314	51317
	60			51318	51321
	80			51319	51322
				51320	51323



51303

P HIGH PERFORMANCE / TIGER ANGLED

Fast Grinding & Long Life on Fillet Welds / Zirconia Alumina / Phenolic Back

Diameter	Grit	Max. RPM	Std. Pack	Type 29	
				7/8" Arbor	5/8"-11 Hub
4-1/2"	40	13,000	10	Item #	Item #
	60			51300	51303
	80			51301	51304
5"	40	12,000	10	51302	51305
	60			51306	51309
	80			51307	51310
				51308	51311

TRIMMABLE DISCS

A trimmable backing plate allows the operator to increase flap overhang. This feature provides the versatility to adjust for hard-to-reach areas such as fillet welds and irregular shapes.

MADE IN USA
WITH GLOBAL MATERIALS



50121

P MAX PERFORMANCE / TIGER CERAMIC TRIM (SABER TOOTH)

Top Coated for Cool Grinding / Ceramic Alumina / Trimmable Composite Back for Versatility

Diameter	Grit	Max. RPM	Std. Pack	Type 29	
				7/8" Arbor	5/8"-11 Hub
4-1/2"	40	13,000	10	Item #	Item #
	60			50117	50121*
	80			50118	50122*
				50119	50123*



50003

P PERFORMANCE / TIGER TRIM

Long Grinding Life / Zirconia Alumina / Trimmable Composite Back for Versatility

Diameter	Grit	Max. RPM	Std. Pack	Type 29	
				7/8" Arbor	5/8"-11 Hub
4-1/2"	40	13,000	10	Item #	Item #
	60			50002	50006*
	80			50003	50007*
	120			50004	50008*
				50005	50009*
5"	40	12,000	10	50010	50014
	60			50011	50015
	80			50012	50016

Key:

P PERFORMANCE LINE Industrial Grade **V** VALUE LINE Professional Grade

*Patent # 6,945,863



MINI DISCS

The expanded mini flap disc line now offers a threaded button R mount in addition to the current S mount for greater versatility to fit the most popular styles of hub pads. These discs are designed for use on die grinders to provide smooth grinding and enhanced conformability in tight areas.

Weiler BobCat Mini Flap Discs are designed and compatible for use on both industry standard hub pads.



S Mount



R Mount



Edge chamfering a fabricated stainless component.

P PERFORMANCE / TIGER® BOBCAT™

Grinding Hard-to-Reach Places
Zirconia Alumina / Composite Back

Diameter	Grit	Max. RPM	Std. Pack	S MOUNT* TYPE 29		R MOUNT+ TYPE 29	
				Item #	Item #	Item #	Item #
2"	36	30,000	10	50922	50932	50946	50956
	40			50923	50933	50947	50957
	60			50924	50934	50948	50958
	80			50925	50935	50949	50959
	120			50926	50936	50950	50960
3"	36	20,000	10	50902	50912	50951	50961
	40			50903	50913	50952	50962
	60			50904	50914	50953	50963
	80			50905	50915	50954	50964
	120			50906	50916	50955	50965

* Back-up pad not required if used with S mount mandrel. 3" discs are compatible with Norton Speed-Lok® TS back-up pads.

+ Back-up pad required. Also compatible with 3M Roloc™ back-up pads.



COATED ABRASIVES

NON-WOVEN ABRASIVES

POWER BRUSHES

NYLOX BRUSHES

PACKAGED ITEMS

MAINTENANCE

ACCESSORIES

BOBCAT DRIVE MANDRELS & METAL HUB PADS

For quick-change on tools with 1/4" collets.

Description	Std. Pack	Item #
2" & 3" S mount mandrel	1	07766
2" S mount hub pad + mandrel	1	60508
3" S mount hub pad + mandrel	1	60509
2" R mount hub pad + mandrel	1	51551
3" R mount hub pad + mandrel	1	51552



ADAPTING NUTS & SPANNER WRENCH

For use with standard, HD and specialty flap discs.

Description	Thread Size	For Use With	Std. Pack	Item #
Adapting Nuts	3/8" - 24	4" flap disc with 5/8" arbor hole (can be used with an adjustable or combination wrench)	1 Pair	56484
Adapting Nuts	5/8" - 11	4-1/2", 5" & 7" flap discs with 7/8" arbor hole	1 Pair	56494
Spanner Wrench	-	Item No. 56494 only	1	56495

When mounting, adapters must be nested, see illustration at left.



RESIN FIBER DISCS



Smoothing the edges of rollercoaster track with a resin fiber disc.

NEW! Faced with the challenge of working on everything from pressure vessels to roller coasters, professionals need a solution they can count on. That's why we've expanded our line up to deliver the options needed to optimize grinding time on a wide variety of applications. With premium grain mixes that aggressively remove metal and a superior design that locks the grain in, Weiler Tiger and Wolverine RFDs are designed to deliver serious grinding solutions.

- Advanced grain formulas designed to maximize cut rate on metals.
- Superior design minimizes loading, glazing, and grain stripping.
- Heavy duty vulcanized fiber backing holds up to the toughest jobs.
- Quick change hub option reduces down time and eliminates interference from adapter rings.
- Spiral molded backing pad design runs cool by increasing airflow and fits on all right-angle grinders.

SELECTING THE RIGHT RFD

<p>P MAX PERFORMANCE</p> 	<p>TIGER® CERAMIC TOP COAT for cool, fast grinding protects from heat discoloration and prevents loading on soft alloys</p>	<p>GRAIN TYPE Ceramic alumina</p> <p>CONTAMINANT FREE CONTAIN LESS THAN 0.1% IRON, SULFUR & CHLORINE</p>	<p>BEST ON</p> <p>STEEL / METAL ALUMINUM</p> <p>STAINLESS HARD-TO-GRIND</p> <p>(Hard-to-grind metals include tool steel, inconel, high nickel alloy, titanium and armored steel)</p>
<p>P HIGH PERFORMANCE</p> 	<p>TIGER ALUMINUM TOP COATING grinds cool and eliminates loading resulting in higher cut rates, long life and a superior finish</p>	<p>GRAIN TYPE Aluminum oxide</p> <p>CONTAMINANT FREE CONTAIN LESS THAN 0.1% IRON, SULFUR & CHLORINE</p>	<p>BEST ON</p> <p>ALUMINUM</p> <p>(Aluminum and other non-ferrous metals)</p>
<p>P HIGH PERFORMANCE</p> 	<p>TIGER ZIRC INFUSED WITH CERAMIC for faster grinding and longer life. Disc design optimizes grain shedding and promotes cool grinding on stainless</p>	<p>GRAIN TYPE Ceramic & zirconia alumina</p> <p>CONTAMINANT FREE CONTAIN LESS THAN 0.1% IRON, SULFUR & CHLORINE</p>	<p>BEST ON</p> <p>STEEL / METAL STAINLESS</p> <p>(Metal includes structural steel and cast iron)</p>
<p>V VALUE PERFORMANCE</p> 	<p>WOLVERINE® ZIRC FAST CUT RATE and consistent performance over the life of the disc, resulting in a great value</p>	<p>GRAIN TYPE Zirconia alumina</p> <p>CONTAMINANT FREE CONTAIN LESS THAN 0.1% IRON, SULFUR & CHLORINE</p>	<p>BEST ON</p> <p>STEEL / METAL STAINLESS</p> <p>(Metal includes structural steel and cast iron)</p>
<p>V VALUE PERFORMANCE</p> 	<p>WOLVERINE AO PREMIUM GRAINS provide an even, sharp, clean cut rate and consistent performance at a great value.</p>	<p>GRAIN TYPE White aluminum oxide</p>	<p>BEST ON</p> <p>STEEL / METAL</p>

TIGER® CERAMIC RESIN FIBER DISCS Ceramic Alumina / Superior Life & Cut Rate on Metal

Self-sharpening Ceramic Alumina grain delivers a superior combination of life and cut rate. Top coat grinds cool and eliminates loading.



P

STEEL / METAL STAINLESS ALUMINUM HARD-TO-GRIND

Diameter	Grit Size	Standard Pack	TYPE 27 7/8" Arbor	TYPE 27 5/8"-11 Hub
			Item Number	Item Number
4-1/2"	24	25	69850	69880
	36		69851	69881
	50		69852	69882
	60		69853	69883
	80		69854	69884
5"	24	25	69857	69887
	36		69858	69888
	50		69859	69889
	60		69860	69890
	80		69861	69891
7"	24	25	69864	69894
	36		69865	69895
	50		69866	69896
	60		69867	69897
	80		69868	69898
9"	24	25	69871	69901
	36		69872	69902
	50		69873	69903
	60		69874	69904
	80		69875	69905

Do not exceed maximum RPM of back-up pad.



BONDED ABRASIVES

COATED ABRASIVES

NON-WOVEN ABRASIVES

POWER BRUSHES

ADVANCED CERAMIC GRAIN
delivers greater stock removal with a finer scratch pattern

LESS PRESSURE
for consistent material removal, reducing operator fatigue

TOP COAT
grinds cool and eliminates loading, glazing & dulling

WIDE RANGE
of grit options professionals need to get a desired finish



TIGER ALUMINUM RESIN FIBER DISCS Aluminum Oxide / Non-Loading on Non-Ferrous Metals

A top coating grinds cool and eliminates loading, which results in higher cut rates, long life and a superior finish.



P

ALUMINUM

Diameter	Grit Size	Standard Pack	TYPE 27 7/8" Arbor	TYPE 27 5/8"-11 Hub
			Item Number	Item Number
4-1/2"	24	25	60400	60600
	36		60401	60601
	50		60402	60602
	60		60403	60603
	80		60404	60604
	120		60406	60606
5"	24	25	60410	60610
	36		60411	60611
	50		60412	60612
	60		60413	60613
	80		60414	60614
	120		60416	60616
7"	24	25	60420	60620
	36		60421	60621
	50		60422	60622
	60		60423	60623
	80		60424	60624
	120		60426	60626

Do not exceed maximum RPM of back-up pad.



NYLOX BRUSHES

PACKAGED ITEMS

MAINTENANCE

TIGER® ZIRC RESIN FIBER DISCS Zirconia Alumina / Ceramic Infused for Faster, Longer Grinding



P

A unique blend of self-sharpening Zirconia Alumina and Ceramic Alumina grains deliver a fast, consistent cut rate. A superior design extends disc life by minimizing grain shedding and promotes cool grinding.

STEEL / METAL **STAINLESS**



Diameter	Grit Size	Standard Pack	TYPE 27 7/8" Arbor	TYPE 27 5/8"-11 Hub
			Item Number	Item Number
4-1/2"	24	25	59731	59931
	36		59732	59932
	50		59733	59933
	60		59734	59934
	80		59735	59935
	100		59736	59936
5"	120		59737	59937
	24	25	59701	59901
	36		59702	59902
	50		59703	59903
	60		59704	59904
	80		59705	59905
100	59706		59906	
7"	120		59707	59907
	24	25	59711	59911
	36		59712	59912
	50		59713	59913
	60		59714	59914
	80		59715	59915
100	59716		59916	
	120		59717	59917

Do not exceed maximum RPM of back-up pad.

WOLVERINE® ZIRC RESIN FIBER DISCS Zirconia Alumina / Fast Grinding on Metal



V

Self-sharpening Zirconia Alumina grain delivers a fast cut rate and consistent performance over the life of the disc, resulting in a great value.

STEEL / METAL **STAINLESS**

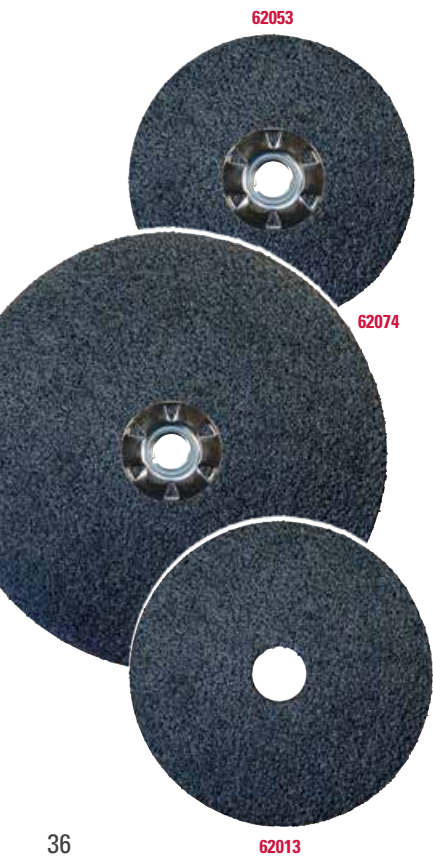

Diameter	Grit Size	Standard Pack	TYPE 27 7/8" Arbor	TYPE 27 5/8"-11 Hub
			Item Number	Item Number
4-1/2"	24	25	62002	62052
	36		62003	62053
	50		62004	62054
	60		62005	62055
	80		62006	62056
	100		62007	62057
	120		62008	62058
	5"		24	25
36		62013	62063	
50		62014	62064	
60		62015	62065	
80		62016	62066	
100		62017	62067	
120		62018	62068	
7"		24	25	
	36	62023		62073
	50	62024		62074
	60	62025		62075
	80	62026		62076
	100	62027		62077
	120	62028		62078
	9"	24		25
36		62033	62083	
50		62034	62084	
60		62035	62085	
80		62036	62086	
100		62037	62087	
120		62038	62088	

Do not exceed maximum RPM of back-up pad.

WOLVERINE® AO RESIN FIBER DISCS White Aluminum Oxide / Fast Grinding on Metal

Premium Aluminum Oxide grains provide an even, sharp, clean cut rate and consistent performance at a great value.



V

STEEL / METAL

Diameter	Grit Size	Standard Pack	TYPE 27 5/8" Arbor	
			Item Number	
4"	24	25	59491	
	36		59492	
	50		59493	
	60		59494	
	80		59495	
	100		59496	
	120		59497	
Diameter	Grit Size	Standard Pack	TYPE 27 7/8" Arbor	TYPE 27 5/8"-11 Hub
			Item Number	Item Number
4-1/2"	24	25	59571	59971
	36		59573	59973
	50		59575	59975
	60		59576	59976
	80		59577	59977
	100		59578	59978
	120	59579	59979	
5"	24	25	59501	61501
	36		59503	61503
	50		59505	61505
	60		59506	61506
	80		59507	61507
	100		59508	61508
	120	59509	61509	
7"	24	25	59521	61521
	36		59523	61523
	50		59525	61525
	60		59526	61526
	80		59527	61527
	100		59528	61528
	120	59529	61529	
9"	24	25	59541	61541
	36		59543	61543
	50		59545	61545
	60		59546	61546
	80		59547	61547
	100		59548	61548
	120	59549	61549	

Do not exceed maximum RPM of back-up pad.



59492



59973



61501

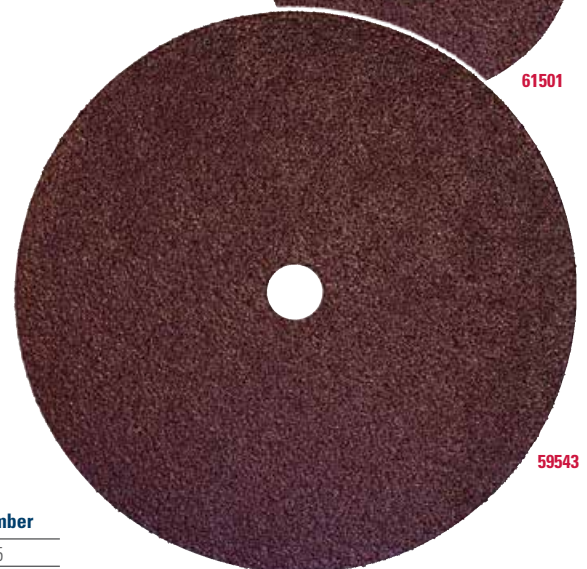

59543



59601



59604



59603

ACCESSORIES FOR RESIN FIBER DISCS

Description	Thread Size	Max. RPM	Standard Pack	Item Number
4" Back-up Pad	5/8"-11*	12,000	1	59605
4-1/2" Back-up Pad	5/8"-11*	11,000	1	59611
5" Back-up Pad	5/8"-11*	10,000	1	59600
7" Back-up Pad	5/8"-11	8,500	1	59601
9" Back-up Pad	5/8"-11	6,500	1	59602
Spanner Wrench	-	-	1	59603
Disc Nut	5/8"-11	-	1	59604

* Other thread sizes available on special orders.

WHY WEILER

BONDED ABRASIVES

COATED ABRASIVES

NON-WOVEN ABRASIVES

POWER BRUSHES

NYLOX BRUSHES

PACKAGED ITEMS

MAINTENANCE

BLENDING DISCS



Blending surface imperfections prior to painting.

Weiler's cloth backed coated abrasive discs are for use on right angle air tools. Available with either a metal hub or a plastic button fastening system, the flexible back-up pads give the discs a great deal of conformability. Weiler's blending discs are suitable for a wide range of light fabrication, repair and maintenance applications.

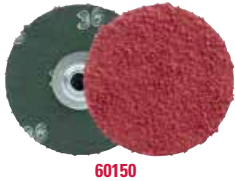

P TIGER® CERAMIC ALUMINA BLENDING DISCS

For aluminum, stainless and other hard-to-grind metal applications.

Diameter	Grit Size	Standard Pack	Item Number	
			Type S Hub Style	Type R Hub Style
2"	36	50	60150	60170
	60		60151	60171
	80		60152	60172
3"	36	25	60155	60175
	60		60156	60176
	80		60157	60177

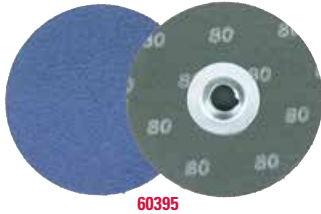

P TIGER BLENDING DISCS - Type S Hub Style

Compatible with Norton Speed-Lok® TS back-up pads.

Diameter	Grit Size	Standard Pack	Item Number	
			Zirconia Alumina	Aluminum Oxide
2"	36	100	60378	60040
	60		60381	60043
	80		60382	60044
	120		60384	60046 •
3"	36	50	60391	60053
	60		60394	60056
	80		60395	60057
	120		60397	60059



P TIGER BLENDING DISCS - Type R Hub Style - Compatible with 3M Roloc™ back-up pads.

Diameter	Grit Size	Standard Pack	Item Number - Aluminum Oxide
2"	36	100	60118
	60		60121
	80		60122
	120		60124
3"	36	50	60131
	60		60134
	80		60135
	120		60137

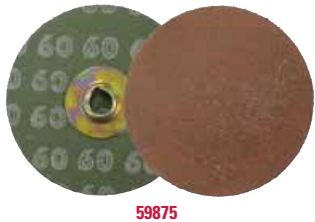

P TIGER ALUMINUM BLENDING DISCS - Aluminum Oxide

Diameter	Grit Size	Standard Pack	Item Number	
			Type R Hub Style*	Type S Hub Style +
2"	36	50	59806	59869
	60		59807	59870
	80		59808	59871
	120		59809	-
	3"		36	59811
3"	60	25	59812	59875
	80		59813	59876
	120		59814	59877 •



P BACK-UP PADS - 1/4" Stem

Diameter	Max. RPM	Std. Pack	Item No.	
			Type R Hub Style*	Type S Hub Style+
2"	25,000	1	51551	60508
3"	20,000	1	51552	60509

Do not exceed maximum RPM of back-up pad.

* Compatible with 3M Roloc™ back-up pads. (Roloc™ is a trademark of 3M.)

+ Compatible with Norton Speed-Lok® TS back-up pads. (Speed-Lok® TS is a registered trademark of Norton Co.)

• Non-stock product, contact Customer Service for lead times

TRIM-KUT® DISCS

Trim-Kuts are abrasive discs designed for light grinding and blending applications on a variety of materials. The abrasive grains are fused directly onto a wearable polymer backing, resulting in a disc that requires no back-up pad. The polymer backing trims during use to expose new grains to the work surface. 3" discs are designed for use on right angle air die grinders, and 4-1/2" discs are for use on right angle grinders.

APPLICATIONS

- Edge blending
- Preparation for painting and surface finishing
- Light weld and stock removal
- Deburring



Deburring and chamfering a section of pipe after cutting.

P TRIM-KUT® DISCS - Aluminum Oxide

Diameter	Arbor Hole	Grit Size	Max. RPM	Standard Pack	Item Number
3"	5/16" - 18	36	21,000	25	59300
		60			59305
		120			59315

Do not use TRIM-KUT discs in temperatures lower than 48° fahrenheit. Store at 50% relative humidity.



COATED ABRASIVES

P TRIM-KUT DISC - Aluminum Oxide

Diameter	Arbor Hole	Grit Size	Max. RPM	Standard Pack	Item Number
4-1/2"	7/8"	36	13,000	25	59403

Do not use TRIM-KUT discs in temperatures lower than 48° fahrenheit. Store at 50% relative humidity.



P TRIM-KUT ADAPTERS

Description	For Use With	Standard Pack	Item Number
1/4" Mandrel	3" TRIM-KUT Discs	25	59327
3/8"-24 UNF Adapter	3" TRIM-KUT Discs	25	59326 •
Adapting Nuts	4-1/2" TRIM-KUT Discs	1	56485
Spanner Wrench	Item No. 56485 only	1	56496 •

• Non-stock product, contact Customer Service for lead times



POWER BRUSHES

NYLON BRUSHES

PACKAGED ITEMS

MAINTENANCE



NOTE

If you are using a blending disc or TRIM-KUT Disc, ask our Application Engineering Department if Weiler's BobCat Abrasive Flap Discs can enhance your productivity. BobCats dramatically outperform blending and TRIM-KUT Discs by reducing changeovers and providing consistently high cut rates and extended life. See page 33 for more information.

Key:

P Performance line
Industrial Grade

V Value line
Professional Grade

COATED ABRASIVE FLAP WHEELS



Weiler's abrasive flap wheels are designed with a solid hub construction that enables wheels to be rated at higher RPMs and provide more aggressive cutting action and increased productivity. They provide perfect balance leading to smooth, chatter-free finishing.

Applications

- Internal diameter cleaning
- Finishing metal surfaces
- Deburring machined parts
- Cleaning and reconditioning pipe threads
- Polishing, blending & finishing
- Prepping surface for painting or plating
- Edge blending



Removing burrs from the inside diameter of a cut tube.



52010



52027



52621



53286

P TIGER® MOUNTED FLAP WHEELS - 1/4" Stem - Aluminum Oxide

A premium line designed to provide long life. Ideal for medium to high production environments.



Diameter	Width	Grit Size	Max. RPM	Standard Pack	Item Number
1"	1"	60	30,000	10	52003
		80			52004
		120			52005
1-1/2"	1"	60	25,000	10	52009
		80			52010
		120			52011
2"	1/2"	60	25,000	10	52366
	80	52367			
2"	1"	60	25,000	10	52015
		80			52016
		120			52017
2-1/2"	1"	60	23,000	10	52486
		80			52487
3"	1/2"	60	23,000	10	52024
		80			52025
3"	1"	60	23,000	10	52027
		80			52028
		120			52029

P TIGER MOUNTED FLAP WHEELS - 1/4"-20 Threaded Stem - Aluminum Oxide

A premium line designed to provide long life. Ideal for medium to high production environments.



Diameter	Width	Grit Size	Max. RPM	Standard Pack	Item Number
1"	1"	60	30,000	10	52601
		80			52603
		120			52605
2"	1"	60	25,000	10	52611
		80			52613
3"	1"	60	20,000	10	52621
		80			52623

P TIGER UNMOUNTED FLAP WHEELS - Aluminum Oxide



Diameter	Width	Arbor Hole	Grit Size	Max. RPM	Standard Pack	Item Number
6"	1"	1"	60	6,000	5	53286
			80			53287
6"	2"	1"	60	5,700	3	53326 •
			80			53327

• Non-stock product, contact Customer Service for lead times

NOTE

- Drive arbor is used individually and must be ordered individually.
- Drive arbor is to be used with Weiler flap wheels only.
- Stems must be fully chucked before using and should not be run above the maximum RPM listed.

Key:

P Performance line
Industrial Grade

V Value line
Professional Grade



GREAT VALUE AT THE RIGHT PRICE

Wolverine Flap Wheels offer a high cut rate at a cost-effective price. The smart option for use in medium production environments.

APPLICATIONS

- Internal diameter cleaning
- Finishing metal surfaces
- Deburring machined parts
- Cleaning and reconditioning pipe threads
- Polishing, blending & finishing
- Prepping surface for painting or plating
- Edge blending

V WOLVERINE® 1/4" STEM MOUNTED FLAP WHEELS

Provide fast cutting action at a value price. Ideal for low to medium production environments.



Diameter	Width	Grit Size	Max. RPM	Standard Pack	Item Number
					Aluminum Oxide
5/8"	5/8"	40	30,000	10	30711
		60			30712
		80			30713
3/4"	3/4"	40	30,000	10	30715
		60			30716
		80			30717
1"	1"	40	30,000	10	30719
		60			30720
		80			30721
		120			30722
1-1/2"	1"	40	25,000	10	30771
		60			30772
2"	1"	40	25,000	10	30732
		60			30723
		80			30724
		120			30725
2-1/2"	1"	40	23,000	10	30778
3"	1"	40	23,000	10	30729
		60			30726
		80			30727
		120			30728



V WOLVERINE 1/4"-20 THREADED STEM MOUNTED FLAP WHEELS

Provide fast cutting action at a value price. Ideal for low to medium production environments.



Diameter	Width	Grit Size	Max. RPM	Standard Pack	Item Number
					Aluminum Oxide
1"	1"	60	30,000	10	30745
		80			30746
2"	1"	60	25,000	10	30737
		80			30738
3"	1"	60	20,000	10	30735
		80			30736



DRIVE ARBOR - For 1/4"-20 Mounted Flap Wheels

Thread Size	Adapted Size	Standard Pack	Item Number
1/4"-20	1/4"	5	07756



METAL ADAPTERS - For Unmounted Flap Wheels. Used in pairs and priced per pair.

Wheel Arbor Hole Size	Adapted Arbor Hole Size	Standard Pack	Item Number
1"	1/2"	1	03833
	5/8"		03834
	3/4"		03835 •



• Non-stock product, contact Customer Service for lead times

COATED ABRASIVE SHOP ROLLS



Polishing the O.D. of a part turning in a lathe.

Weiler's Shop Rolls are resin over resin bonded - providing a stronger, heat and moisture resistant bond that better utilizes the abrasive grains. The cotton cloth provides a tougher, durable backing for longer life. J-flex cloth provides a higher degree of flexibility to conform to contoured parts.

APPLICATIONS

- Off-hand polishing of metal surfaces
- Off-hand deburring
- General purpose machine shop use
- Cleaning stock that is being turned in a lathe

P TIGER® SHOP ROLLS - Aluminum Oxide - 50 Yards. One roll per box.

Roll Width	Grit Size	Standard Pack	Item Number
1"	50	1	65204
	60		65205
	80		65206
	100		65207 •
	120		65208
	150		65209 •
	180		65210 •
	240		65212 •
1-1/2"	320	1	65213
	60		65218
	80		65219
	100		65220
	120		65221
	150		65222
	180		65223
	240		65225
2"	320	1	65226
	60		65231
	80		65232
	100		65233
	120		65234
	150		65235
	180		65236
	240		65238
	320		65239

• Non-stock product, contact Customer Service for lead times



65204

NOTE

Use light machine oil with shop rolls as a lubricant for finer finishes and quicker cut.

Key:

P Performance line
Industrial Grade

V Value line
Professional Grade

NON-WOVEN ABRASIVES

FINEST AT THE FINISH

Non-woven abrasive products can be used in a broad range of surface-conditioning applications from cleaning and finishing to deburring and light blending. Unlike bonded and coated abrasives, they cannot be used for applications requiring heavy stock removal such as grinding and weld blending.

Non-Woven Abrasives Overview	44
Unitized Wheels	44
Interleaf Flap Wheels	45
Hand Pads	45
Surface Conditioning Discs.....	46



SELECTING THE RIGHT PRODUCT

The various grades of non-woven products produce scratch patterns that can be compared to those produced by coated abrasive products. However, their pliable nature results in a softer, less pronounced scratch-line pattern. The strength of these products is producing decorative finishes ranging from satin to near-mirror polish.

Denser non-woven products are suitable for applications requiring light stock removal such as removing large, well-attached burrs and blending minor tool marks and imperfections.

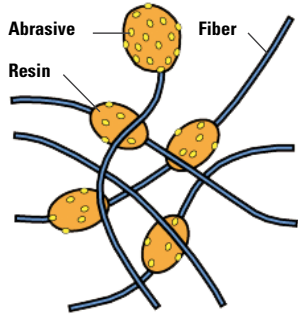

All non-woven products are fabricated from base materials that are composed of a random "web" of nylon fibers that have been bonded together with synthetic resins and impregnated with abrasive grains. Although these materials vary in fiber density, their three dimensional nature results in specialty abrasive products that are pliable, conformable to the work surface, and limited in their ability to remove base stock.

Non-woven products resist loading and perform consistently as new, fresh abrasive grains are exposed as the nylon fibers wear away from the product during use. Non-woven abrasives can be used either wet or dry on a range of materials including ferrous and non-ferrous metals, ceramics, plastics, composites, and wood. Non-woven products are designed for use where stock removal is not required. Non-wovens begin where coated abrasives leave off.

Grade	Grit Range
Ultra Fine	600
Very Fine	240-360
Fine	180-220
Medium	100-150
Coarse	50-80

UNITIZED WHEELS



55512



55541

P **UNITIZED WHEELS** - Designed for use on die grinders and are ideal for a variety of cleaning, finishing, deburring and edge blending applications.



Diameter	Face Width	Arbor Hole	Grain	Grade	Max. RPM	Standard Pack	Item Number
Series 2 - Cleaning & Finishing - Hardness: Soft							
3"	1/4"	1/4"	Aluminum Oxide	Fine	12,000	10	55512
	1/4"		Silicon Carbide	Fine			55513 •
Series 6 - Deburring - Hardness: Medium/Hard							
1"	1"	3/16"	Aluminum Oxide	Fine	30,000	10	55531 •
3"	1/4"	1/4"	Aluminum Oxide	Fine	18,000		54492
Series 8 - HD Deburring & Polishing - Hardness: Hard (Heavy-Duty)							
3"	1/8"	1/4"	Aluminum Oxide	Coarse	18,000	10	55546
	1/4"			Medium			55541
	1/2"			Medium			55542

• Non-stock product, contact Customer Service for lead times

MANDRELS



56489

Stem Diameter	For Wheel Diameter	For Wheel Thickness	Standard Pack	Item Number
1/4"	2" - 3"	1/2"	1	07761
	1"	1"	1	07764 •
	2" - 3"	1/8" - 1/4"	10	56489

• Non-stock product, contact Customer Service for lead times

INTERLEAF FLAP WHEELS

Interleaf Flap Wheels provide a combination of non-woven and coated abrasive material to produce a very conformable product compared to a standard coated abrasive flap wheel. They are designed to be a finishing and surface blending tool as compared to a material-removing coated abrasive flap wheel. They are ideal for producing satin or decorative finishes on irregular or contoured surfaces.

APPLICATIONS

- General decorative finishing
- Applying satin finishes
- Producing antique finishes
- Final sandings
- Soft metal finishing
- Removing oxides from precious metals
- Fine burr removal

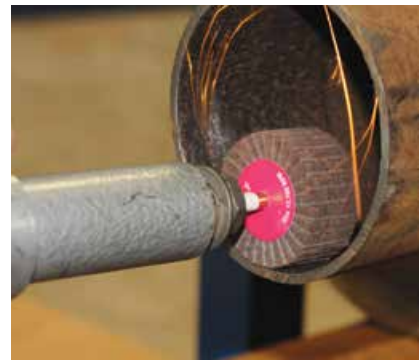

Deburring the I.D. of a steel pipe with an interleaf flap wheel.

P STEM-MOUNTED INTERLEAF FLAP WHEELS - Aluminum Oxide

Diameter	Face Width	Grit Size	Stem Size	Max. RPM	Standard Pack	Item Number
2"	1"	120	1/4"	13,700	10	54500
		180				54501
		320				54502
3"	1"	120	1/4"	8,600	5	54506
		180				54507
		320				54508
3"	2"	120	1/4"	8,600	5	54509
		180				54510
		320				54511



54500



54510

COATED ABRASIVES

NON-WOVEN ABRASIVES

HAND PADS

Industrial Grade:

- Producing satin finishes on aluminum and stainless steel
- Light deburring
- Surface preparation
- Blending light scratches

Commercial Grade:

- Cleaning and removing stains from stainless steel
- Removing rust, corrosion and oxidation



Polishing a rail axle journal with a non-woven hand pad.

POWER BRUSHES

NYLOX BRUSHES

P HAND PADS - For cleaning and conditioning surfaces by hand. Unlike steel wool, hand pads are non-metallic, and do not produce "after-rust" on work surfaces. Hand pads can be used in wet applications.

Size	Grain	Grade	Description	Standard Pack	Item Number
Industrial Grade					
6" x 9"	Silicon Carbide	Ultra Fine	Finishing (Grey)	60	51434
6" x 9"	Aluminum Oxide	Medium	Economy General Purpose (Maroon)	60	51460
6" x 9"	Aluminum Oxide	Med/ Coarse	General Purpose (Maroon)	60	51444
6" x 9"	Aluminum Oxide	Heavy-Duty	Heavy-Duty (Tan)	40	51454
Commercial Grade					
6" x 9"	Aluminum Oxide	Fine	Economy (Green)	400	51456
6" x 9"	Aluminum Oxide	Medium	Standard-Duty (Green)	60	51457
6" x 9"	Aluminum Oxide	Heavy-Duty	Heavy-Duty (Green) 20% thicker than Standard Duty	60	51458

51460

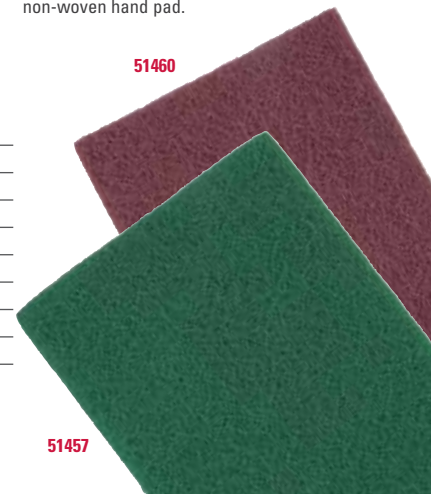

51457



SURFACE CONDITIONING DISCS

Surface Conditioning Discs have an open construction, scrim reinforcement and a superior resin system. These features minimize loading, heat build-up, fraying of disc edges, grain shedding and extend disc life, providing superior performance.

APPLICATIONS

- Light deburring
- Surface preparation
- Blending light scratches
- Removing rust, corrosion and oxidation
- Cleaning and removing stains from stainless steel
- Producing satin finishes on aluminum and stainless steel

Finishing the surface for a stainless steel part for the food service industry.



51532



51533



51552

P TYPE R HUB STYLE DISCS - General Purpose

Compatible with 3M Roloc™ back-up pads.



Diameter	Grade	Standard Pack	Item Number
2"	Very Fine (Blue)	50	51530
	Medium (Maroon)		51531
	Coarse (Brown)		51532
3"	Very Fine (Blue)	25	51533
	Medium (Maroon)		51534
	Coarse (Brown)		51535

TYPE R HUB STYLE BACK-UP PADS - 1/4" Stem

Diameter	Max. RPM	Standard Pack	Item Number
2"	30,000	1	51551
3"	20,000	1	51552

Do not exceed maximum RPM of back-up pad.

P HOOK & LOOP STYLE DISCS



51508

Diameter	Grade	Standard Pack	Item Number
3"	Very Fine (Blue)	25	51506 •
	Medium (Maroon)		51507 •
	Coarse (Brown)		51508 •
4-1/2"	Very Fine (Blue)	10	51512
	Medium (Maroon)		51513
	Coarse (Brown)		51514
5"	Very Fine (Blue)	10	51515
	Medium (Maroon)		51516
	Coarse (Brown)		51517
7"	Very Fine (Blue)	10	51521
	Medium (Maroon)		51522
	Coarse (Brown)		51523

• Non-stock product, contact Customer Service for lead times



51578

HOOK & LOOP STYLE BACK-UP PADS

Diameter	Arbor Hole or Stem Size	Max. RPM	Standard Pack	Item Number
3"	1/4" Stem	18,000	1	51562
4-1/2"	5/8"-11 Arbor	13,000	1	51569
5"	5/8"-11 Arbor	10,000	1	51575
7"	5/8"-11 Arbor	6,000	1	51578



CHOOSE QUALITY

Superior construction, the highest quality materials, state of the art manufacturing, and exacting quality standards deliver the most consistent brush performance. Each Weiler brush is designed to provide the best performance at the lowest cost-of-use.

That's why we re-engineered our 4" stringer bead brush to deliver MAXimum impact, letting the wire do the work. Our beefed up Roughneck® Max brush delivers up to twice the life. Combine that with the hardest, strongest wire and an improved knot design to MAXimize cleaning power and you have a brush that you can trust when your name is on the line.

Technical Information	48-56
Knot Wire Wheels.....	57-63
Weld Cleaning Brushes	62-63
Crimped Wire Wheels.....	64-71
Nylon & Tampico Wheels	72
Cup Brushes	73-75
Stem-Mounted End Brushes.....	76-79
Crosshole Deburring Brushes	80
Power & Hand Tube Brushes.....	81-85
Crossflex Honing Brushes.....	86-89
Miniature Brushes.....	90-91
Non-Sparking Brushes	92-93
Strip Brushes.....	94-97
Wide Face Brushes.....	98-99

POWER BRUSHES

SOLUTIONS SHOWCASE

TUBE END DEBURRING

Problem: Structural tubing is fabricated into an abundance of different forms. In order to facilitate safer handling and proper fit, the ends of the tubing must frequently be deburred.

Solution: Wide face crimped wire wheel brushes are an extremely effective solution for tube end deburring. Brushes can deburr the OD and ID of tubing at an extremely high rate and produce a media-cost-per-part of considerably less than \$0.01 per part.



GEAR DEBURRING

Problem: Power transmission components like gears cannot function properly when burrs prevent correct engagement. Further, burrs that become detached from gears can become lodged in critical transmission components causing premature wear and potential failure.

Solution: Knot wire wheel brushes with surface speed in excess of 6,000 SFPM are an excellent solution for deburring gears prior to heat treatment. The high energy filament tips are able to separate burrs from base material and produce a uniform edge break, which protects the edge of the gear.



Photos courtesy of On-Line Services.

REMOVAL OF MILL SCALE

Problem: Mill processing of steel often involves heat treating and oil quenching operations that produce an adherent scale, which must be removed prior to joining or finishing operations.

Solution: Wire brushes are capable of quickly cleaning material to white metal and producing varying degrees of surface roughening to promote adhesion. Brushing operations are often preferred over blasting and chemical processes that generate an expensive waste stream and can be costly to operate and maintain.



INTER-PASS PIPELINE WELD CLEANING



Problem: To prevent voids and inclusions when welding multi-pass joints, the surface of each bead must be completely cleaned of slag and other residuals. Performing inter-pass weld cleaning as quickly and as thoroughly as possible is critical to avoiding costly repair work and delays.

Solution: Weiler's Roughneck® and Dually® stringer bead wheels have been engineered to maximize efficiency and minimize costs and are the preferred choice of welders' helpers on the pipeline. From hot pass to cap pass, these premium weld cleaning brushes excel at quickly and thoroughly removing slag, spatter, and oxidation without damaging the filler material.

CLEANING THREADED CONNECTIONS



Problem: The box ends of drill string and other oilfield tubular goods are examples of connections that must be periodically cleaned without altering the geometry of the threads. Abrasive products all remove base material to some extent and are capable of damaging threads, resulting in unreliable connections and the risk of potential failures.

Solution: The conformability and impact action of small diameter crimped wire wheels make them ideal tools for cleaning threads without fear of damage. When used on a high-speed die grinder, these radial wheel brushes quickly remove residual dope as well as rust, corrosion and scale from male or female thread ends.

REMOVAL OF EXCESS MOLDED RUBBER



Problem: Mechanical rubber components such as motor mounts are produced through a process that commonly leaves flash and excess rubber on critical surfaces. In order for the component to function properly, this unwanted material must be removed.

Solution: The non-loading nature of wire brushes makes them the best available solution in the marketplace for removal of rubber from targeted surfaces. This solution can be implemented off-hand or using automated equipment.

SELECTING THE RIGHT BRUSH

SELECTION BY TOOL

	Crimped Wheels	Knot Wheels	Crimped Cups	Knot Cups	Crimped Stem-Mtd. Wheels	Knot Stem-Mtd. Wheels	Crimped Stem-Mtd. End	Knot Stem-Mtd. End	Encapsulated Brushes	Power & Hand Tube Brushes	Mini Brushes
Right Angle Grinder	✓	✓	✓	✓					✓		
Straight Grinder	✓	✓			✓	✓	✓	✓	✓		
Die Grinder	✓	✓			✓	✓	✓	✓	✓		
Corded/Cordless Hand Drill					✓	✓	✓	✓		✓	
High Speed Pencil Grinder											✓
Bench/Pedestal Grinder	✓	✓							✓		
Drill Press					✓	✓	✓	✓		✓	
CNC/Milling/Automatic Machine	✓	✓	✓	✓	✓	✓	✓	✓	✓	✓	

WIRE SIZE

To maximize brush life and reduce costs, always use the finest wire that will accomplish the job without requiring excessive applied pressure or engagement with the brush face.

Wire	Coarse		Medium to Coarse		Medium		Fine		Very Fine	
Gauge #	20	24	25	30	33	34	35	38	43	47
Dia. in Inches	.035	.023	.020	.014	.0118	.0104	.0095	.008	.006	.005
Dia. in Millimeters	0,89	0,58	0,51	0,36	0,30	0,26	0,24	0,20	0,15	0,13

Wire sizes in decimals of an inch are shown in all tables throughout this catalog. American Steel Wire Equivalent Gauge (Formerly Washburn & Moen)

LARGE DIAMETER WIRE

- Aggressive brushing action
- Fatigues and breaks more quickly

SMALL DIAMETER WIRE

- Resists fatigue and breakage
- Less aggressive
- Flexible brushing action

CRIMPED VS. KNOT WIRE

CRIMPED WIRE BRUSHES:



- Wire is crimped to allow individual filaments to support each other.
- Provide flexibility for light/medium duty applications.
- Use on parts that could be damaged by the impact of a knot brush.
- Use for a broad range of applications.

KNOT WIRE BRUSHES:



- Straight wire filaments that are twisted as a single unit like a piece of cable or wire rope.
- Provide less flexibility and more aggressive brushing action in heavy-duty applications.
- Use on parts requiring high-impact action.
- Use to remove large burrs and heavy contamination, such as multiple layers of rust, scale, paint or oxides.

KNOT TWIST CONFIGURATIONS



STANDARD

Provides some flexibility for use on irregular surfaces. Sharp wire tips make this knot aggressive right from the start.



HURRICANE®

Provides smoother operation but sacrifices much of the cleaning action.



CABLE

Provides very aggressive brushing action. Sharp wire tips make this knot aggressive right from the start.



STRINGER BEAD

High-impact action, primarily for weld cleaning. Sharp wire tips make this knot aggressive right from the start.

TRIM LENGTH & FILL DENSITY

To maximize brush life and reduce costs, always use the shortest trim, highest density brush that will adequately conform to the surface or part edges.

LONG TRIM, LOW DENSITY BRUSHES

- Flexibility that is ideal for applications such as cleaning surfaces that are somewhat irregular
- Lower fill density can result in shorter brush life and less consistent performance in production environments.

SHORT TRIM, HIGH DENSITY BRUSHES

- Less flexible and faster action requires less applied pressure
- Consistent performance and longer life

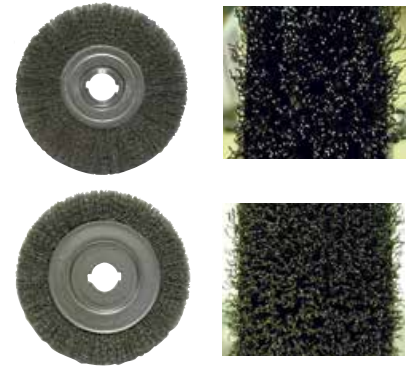

POLYFLEX® ENCAPSULATED

These brushes are suitable for extremely demanding applications that do not require a high degree of conformability. They are especially well-suited for users with the following types of requirements:

Extreme brushing pressure - Encapsulation protects wires from over-flexing and extends brush life relative to conventional knot and crimped wire brushes.

Severe cleaning operations - Encapsulation holds the wire tips rigidly in place and creates the most aggressive brushing action that can be achieved with a wire brush.

BURGUNDY (STANDARD)



General purpose elastomer; suitable for most manufacturing applications.

ORANGE (HEAVY-DUTY)



A more heavy-duty elastomer than burgundy; used for more demanding applications.

BLACK (EXTRA HEAVY-DUTY)



A heat stabilized elastomer that does not wear easily; used primarily for cleaning welds.

ARBOR HOLE VARIATIONS

FOR WEILER PERFORMANCE LINE WHEELS

If an arbor hole size other than the size listed in the product table is required, change the last digit of the Item Number as indicated in the Table.

Arbor Hole Diameter	Arbor Hole Features	Change Last Digit of Item # To:
1/2"-3/8"	Plastic Snap-Out Adapter	4
5/8"-1/2"	Plastic Snap-Out Adapter	5
5/8"-11 UNC	Threaded Nut (6", 7" & 8" Wheels Only)	6
5/8"	3", 4" & 6" Wheels Only	7
3/4"	—	8
7/8"	—	0 - 11
1"	1/4"*x 1/8"+ double keyway	0 - 12
1-1/4"	5/16"*x 5/32"+ double keyway	9
1-1/2"	3/8"*x 3/16"+ double keyway	0 - 13
1-3/4"	3/8"*x 3/16"+ double keyway	0 - 16
2"	1/2"*x 1/4"+ double keyway	0 - 14
2-1/4"	3/4"*x 3/8"+ double keyway	0 - 17
2-1/2"	1/2"*x 1/4"+ double keyway	0 - 15

* Width of keyway

+ Depth of keyway

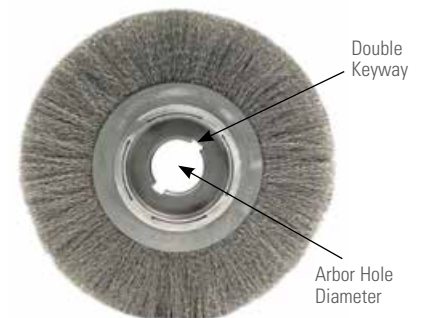

Example: Item Number 01228 has a listed, standard size arbor hole of 3/4". If an 1-1/4" arbor hole is desired, drop the 8 from 01228 and add 9. The Item Number becomes 01229. If a 2" arbor hole is desired, drop the 8 from 01228 and add 0-14. The Item Number becomes 01220-14.

PRODUCT ADVANTAGES

PRODUCT LINE STRUCTURE

P PERFORMANCE LINE (INDUSTRIAL GRADE)

Engineered and manufactured to maximize performance and minimize operating costs in the most demanding surface conditioning applications. The use of superior construction, the highest quality materials and the most stringent manufacturing processes deliver the lowest cost-of-use and most consistent performance in heavy production environments.

V VALUE LINE (PROFESSIONAL GRADE)

Weiler's value line is manufactured using similar product construction and the same exacting standards as other Weiler power brushes, but engineered to provide cost-effective use in less demanding environments. Wolverine™ brushes (Formerly Vortec Pro®) are an economical choice for the construction trades, low volume production shops and light duty industrial MRO use.

OPERATIONAL ADVANTAGES

POWER BRUSHES DO NOT REMOVE BASE MATERIAL

- The impact action of the wire tips of a rotating brush behave in the same manner as the media in a blasting operation and they have the same ability to separate surface contaminants without damaging the substrate.
- Due to its compliant nature, a power brush is the ideal tool for removing burrs and blending sharp edges without changing overall part dimensions after sawing, cutting, grinding and machining operations.

Grinding Wheel



Wire Wheel



POWER BRUSHES DO NOT LOAD

Unlike bonded, coated and non-woven abrasive products, power brushes will not load when used on softer materials or when removing paint or similar coatings from a harder surface. Because a power brush consists of a collection of individual wire filaments, there is no place for debris to accumulate and prevent the sharp wire tips from striking the work.

Resin Fiber Disc



Wheel Brush



POWER BRUSHES ARE SELF-SHARPENING

As a power brush is used, the wire tips will naturally tend to wear to a point due to contact with the working surface. It is possible to take advantage of this self-sharpening action by periodically switching the mounting position of wheel brushes to maintain their speed and effectiveness.

WEILER SUPERIOR CONSTRUCTION



WEILER'S SOLID RING CONSTRUCTION

Our crimped wire brushes are constructed using solid rings to retain the fill material and our manufacturing process results in an even, consistent distribution of wire strands around the entire brush diameter. This ensures that our crimped wire products run smoother and last longer than the competition – even in the toughest applications.



WEILER'S INDIVIDUAL KNOT HOLE CONSTRUCTION

Weiler's knot wheels are constructed with an internal steel plate that has equally spaced individual holes around the perimeter. Wire is inserted through each hole and twisted into a knot. Each hole has precisely the same wire count, thereby assuring perfect balance. This eliminates vibration, reduces operator fatigue and increases brush life.

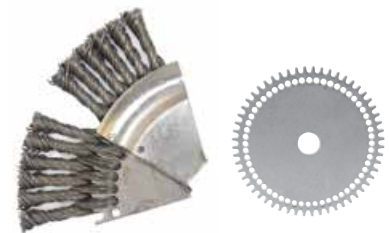

WEILER'S ROUGHNECK® WELD CLEANING BRUSH CONSTRUCTION

Each knot is twisted through its own hole and locked into an individual sprocket tooth. This prevents the knots from moving, providing a stronger striking action on the work surface, longer brush life and less operator fatigue. This results in the most aggressive weld cleaning in the market with the lowest cost-per-piece brushed.

PRODUCT CHARACTERISTICS

WHEEL BRUSH

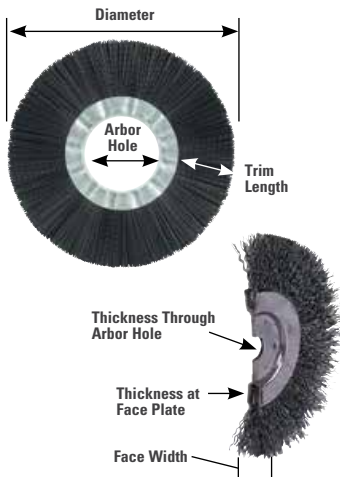

CUP BRUSH



END BRUSH



TUBE BRUSH

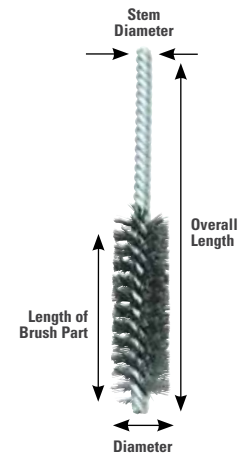

FILL MATERIALS



Steel Wire - Carbon steel wire is the most durable power brush fill material for metalworking and heavy-duty cleaning applications. **Weiler industrial grade brushes** utilize heat treated, high tensile steel wire that has been drawn to the most exacting industry standards for superior fatigue resistance and aggressive brushing action. **Vortec Pro® professional grade brushes** utilize more cost-effective grades of steel wire to deliver reliable performance in less demanding applications.



Stainless Steel Wire - Stainless steel wire is only recommended when brushing corrosion-resistant or non-ferrous metals such as stainless or aluminum or when the brush is being used in a wet environment. Stainless steel wire is not any more durable or aggressive than the highest grades of steel wire. All Weiler stainless steel brushes are manufactured with Type 302 stainless wire, but select items are also available with Type 316 wire by special order.



Non-Ferrous Wire - Brass, bronze and aluminum wire are available in assorted Weiler industrial grade power brush items. These non-ferrous materials will not generate a spark in use, but they lack the durability of carbon steel and stainless steel wire. Due to their soft brushing action, these materials may also be used in special applications such as decorative finishing.



Animal Hair - Natural hair bristle is used primarily in miniature power brushes for scratch-free cleaning and polishing. Depending on the animal species and type of hair, this fill material can range from relatively stiff to relatively soft, making it suitable for a variety of applications from removing dust from optical lenses to buffing precious metals using abrasive compounds.



Vegetable Fiber - Tampico, a natural fiber produced from the Mexican agave plant, is a common natural fill material used in wet scrubbing and cleaning applications as well as buffing and polishing metals. It is heat, alkali and acid resistant. Its natural color is off-white but it may be dyed or bleached.



Synthetic - Nylon is typically the most durable synthetic bristle material for use in power brushes and can be used in a variety of applications due to its flexibility, high fatigue strength and resistance to abrasion, heat, acids and alkali. Polypropylene is less durable and used primarily in strip brushes.

STAINLESS STEEL BRUSHES

Weiler's stainless steel wire brushes are manufactured using wire drawn from Type 302 stainless steel. Although 302 stainless is typically a non-magnetic material, it is important to remember that the amount of cold-working that it experiences during the wire-drawing process causes it to become magnetic. For this reason, proper storage and handling of stainless steel brushes is critical to prevent cross-contamination and "after rust" issues. Type 302 is widely used in the manufacture of power brushes for its relative durability

and aggressive action as well as for its austenitic properties that insure the corrosion resistance of the materials on which it is applied. The use of a different grade of stainless steel wire is typically required in critical weld preparation and cleaning applications, but it will not address "after rust" and other cross-contamination issues. To insure the corrosion resistance of any stainless steel surface after brushing, passivating it with a 10-20% solution of nitric acid is recommended.

WORK SAFER WITH PROPER BRUSH USAGE

Weiler products are designed and manufactured to the strictest standards to ensure the highest level of quality and safety. But safety doesn't stop there; raising awareness of basic safety practices and thinking about safety before the job starts — and after the job is complete — can help curb accidents and injuries in the shop. That's why Weiler offers customers a Safety Training Program based on the **SPOT (Speed & Size, Pressure, Orientation, Time)** methodology to help promote safe and proper product usage.



Deploying our **SPOT Safety Training Program** in your facility helps improve safety, regardless of your application or work environment.

For **SPOT Safety Training** contact your Weiler representative.

SPEED & SIZE

- Power brushes, operate most effectively when the speed and pressure of the operation are properly matched to the demands of the application. In most operations, the highest speed and lightest pressure will ensure the fastest brushing action and longest brush life.
- Increasing brush speed increases the face hardness and brushing action; therefore, a fine wire brush rotating at a higher speed will often produce the same results as a coarser wire brush rotating at a slower speed. Finer wire operating at a higher speed is generally preferred and will provide a longer brush life.
- MSFS - Maximum Safe Free Speed (RPM) is the maximum speed at which the brushes may be used safely but is not necessarily the optimum speed for a given application. Operating speed should be determined by the application. When running a wire

brush, a rule of thumb is to run it a "mile a minute" or a minimum of 5,000 Surface Feet Per Minute (SFPM). However, never exceed the Maximum Safe Free Speed of the brush.

- Make sure spindle size and motor of machine are large enough to accommodate the diameter of brush to be used (see table on pg. 55).



Match the RPM rating of the power brush to the tool being used. The RPM of the tool should never exceed the RPM of the power brush.

RECOMMENDED SURFACE SPEEDS FOR BRUSHING APPLICATIONS

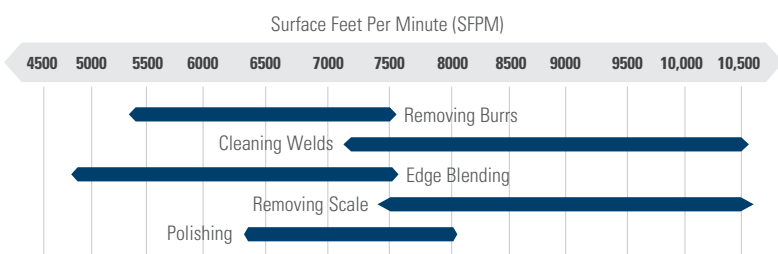

$$\text{SFPM} = \frac{\pi \text{ Dia. (Inches)} \times \text{RPM}}{12}$$

SURFACE SPEEDS (PERIPHERAL SPEED IN FT./MIN.)

RPM	Diameter (Inches)							
	2	3	4	6	8	10	12	15
1000	525	785	1,050	1,575	2,100	2,625	3,150	3,925
1500	785	1,175	1,575	2,350	3,150	3,925	4,725	5,900
1750	915	1,375	1,850	2,750	3,650	4,550	5,500	6,800
2500	1,300	1,950	2,625	3,925	5,250	6,550	7,850	9,825
3000	1,575	2,350	3,125	4,725	6,275	7,850	9,425	11,775
3450	1,800	2,700	3,600	5,400	7,200	9,000	11,000	13,500
4000	2,100	3,150	4,175	6,275	8,375	10,475	—	—
6000	3,125	4,700	6,275	9,425	—	—	—	—
10,000	5,250	7,850	10,500	—	—	—	—	—
15,000	7,850	11,775	15,750	—	—	—	—	—
20,000	10,450	15,700	20,950	—	—	—	—	—

Example: A 6" diameter wheel running at 3,450 RPM has a surface speed of 5,400 SFPM.

MINIMUM RECOMMENDED SPINDLE DIAMETER (From ANSI Standard B165.1)

Outside Dia. of Wheel Brush	Maximum Face Width of Wheel Brush	Minimum Outside Dia. of Spindle (Shaft)
2"	1/4"	1/4"
3"	3/4"	1/4"
3" (heavy-duty)	1"	3/8"
4"	1"	3/8"
6"	1-1/4"	1/2"
8"	1-1/4"	5/8"
10"	2"	3/4"
12"	3"	1"
14"	3"	1-1/4"
15"	3"	2"
16"	3"	2"

Note: These diameters are based on the wheel brush being mounted next to the supported end of the shaft rather than the unsupported end in order to minimize overhang.

RECOMMENDED MOTOR SIZES (Based on 1" Brush Face)

Brush Diameter	Motor Size	RPM
4"	1/4 HP	3,450
6"	1/2 HP	3,450
8"	3/4 HP	3,450
10"	1 HP	1,750
12"	1 HP	1,750
15"	1-1/2 HP	1,750

PRESSURE

Avoid excessive pressure when using a wire brush. Excessive pressure causes over-bending of the filaments and heat build-up resulting in filament breakage, rapid dulling and reduced brush life.

INSTEAD OF GREATER PRESSURE, TRY:

- A brush with more aggressive action (increase filament diameter, decrease trim length, different brush type, i.e.; knot type instead of crimped type).
- Higher surface speed (increase RPM or brush diameter)

Never exceed the recommended Maximum Safe Free Speed or RPM rating of the brush.



Correct
Wire Tips Doing the Work

Incorrect
Excessive Pressure Causes Wire Breakage

ORIENTATION

WORKING ANGLE BY BRUSH TYPE

Never stray more than 15° from the suggested working angles of the brush configurations below.

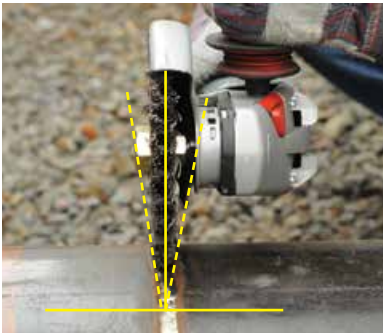

WHEEL +/- 15°



CUP +/- 15°

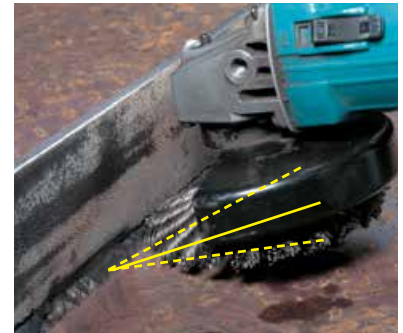

BEVEL +/- 15°

TIME

Reduce the time it takes to get the job done by choosing the most appropriate product configuration. (See page 53 for product selection information.)

SELF-SHARPENING OF WIRE WHEEL BRUSHES

When using wire wheel brushes without nuts, periodically reverse the direction of rotation to take advantage of the self-sharpening action that will result. Remove the brush from the spindle, flip the wire brush 180° and remount the brush securely.



Remove



Flip 180°



Remount Securely

POWER BRUSH TROUBLESHOOTING GUIDE

There are many variables in power brush applications. If the power brush you are using does not accomplish the desired results, select a solution from the suggestions below for your specific application or call Weiler's Application Engineering Hotline at 888-299-2777.

Problem	Recommended Solutions
Brush works too fast	<ul style="list-style-type: none"> • Select a brush with longer filaments and/or lower fill density • Select a brush with a smaller diameter wire • Select a brush with a narrower face and/or lower fill density • Select a brush with a smaller outside diameter • Operate the brush at a slower RPM
Brush works too slowly	<ul style="list-style-type: none"> • Select a brush with shorter filaments and/or higher fill density • Select a brush with a larger diameter wire • Select a brush with a wider face and/or higher fill density • Select a brush with a larger outside diameter • Operate the brush at a faster RPM
Brushing action rolls or peens the burr over instead of removing burr	<ul style="list-style-type: none"> • Select a brush with a larger diameter wire • Select a brush with shorter filaments and/or higher fill density • Operate the brush at a faster RPM • Replace the crimped wire brush with a knot wire brush
Finer final finish required	<ul style="list-style-type: none"> • Select a brush with longer filaments • Select a brush with a smaller diameter wire • Operate the brush at a higher RPM • Replace the wire brush with a nylon abrasive brush (Nylox[®])
Coarser final finish required	<ul style="list-style-type: none"> • Select a brush with shorter filaments • Select a brush with a larger diameter wire • Operate the brush at a slower RPM
Non-uniform brushing action	<ul style="list-style-type: none"> • Select a brush with longer filaments • Select a brush with a larger diameter wire • Automate the operation to reduce human variables
Filaments break off	<ul style="list-style-type: none"> • Reduce applied pressure or engagement • Select a brush with a smaller diameter wire • Select a brush with a lower fill density
Short brush life	<ul style="list-style-type: none"> • Reduce applied pressure or engagement • Select a brush with a smaller diameter wire • Select a brush with a higher fill density

NEED HELP?

Call our Application Engineering Hotline at 888-299-APPS (2777). If the problem is too complex to be solved over the phone, we will determine if an evaluation should be conducted at our in-house lab or your facility. Either way, Weiler will provide the most cost-effective solution for your specific application.

KNOT WIRE WHEELS WITH ARBOR HOLE

Knot wire wheels with arbor holes are intended for use on straight grinders and stationary machines such as bench or pedestal grinders and buffing lathes. Featuring Weiler's individual knot hole construction, these radial brushes are available in heat-treated steel, Type 302 stainless steel, and bronze wire for use in a wide variety of applications.

APPLICATIONS

- Removing rust, scale and heavy corrosion
- Surface roughening and preparation
- Coating removal
- Removing excess molded rubber or plastic
- Heavy deburring

MADE IN USA



Removing rubber coating from a hydraulic hose.

P STANDARD TWIST WHEELS provide heavy-duty brushing action with some flexibility; ideal for demanding cleaning applications on somewhat irregular surfaces.



Dia.	Wire Size	Arbor Hole	No. of Knots	Face Width	Trim Length	Max. AH Avail.	Thickness at Face Plates	Max. RPM	Std. Pack	Item Number	
										Steel	Stainless
3"	.0118	1/2"-3/8"	20	3/8"	5/8"	1/2"	7/16"	25,000	10	08004	08254
	.014									08014 ■	08264 ■
	.020									08024 ▲	08274
4"	.0118	1/2"-3/8"	24	1/2"	7/8"	1/2"	7/16"	20,000	10	08034	08284
	.014									08044 ■	08294
	.020									08064	08314
4"	.014	5/8"-1/2"	24	1/2"	7/8"	7/8"	7/16"	20,000	10	08045	—
6"	.0118	5/8"-1/2"	24	1/2"	1-3/8"	1-1/4"	9/16"	9,000	10	08075	08325
	.014									08085 ■	—
	.016									08095	08345
	.023									08105	—
6"	.016	5/8"-1/2"	30	5/8"	1-1/4"	1-1/4"	5/8"	9,000	5	08975	—
7"	.014	5/8"	24	5/8"	1-7/8"	1-1/4"	9/16"	9,000	2	08835	—
8"	.0118	5/8"	38	5/8"	1-5/8"	2"	1/2"	6,000	2	08125	08375
	.014									08135	—
	.016									08145	08395
	.023									08155	—
8"	.014	3/4"	38	5/8"	1-5/8"	2"	1/2"	6,000	2	08138	—
10"	.014	3/4"	52	3/4"	1-3/4"	2-1/2"	3/4"	4,500	2	08178	—
10"	.014	1-1/4"★	52	3/4"	1-3/4"	2-1/2"	3/4"	4,500	2	08179	—
	.016									08189	—
12"	.014	1-1/4"★	52	3/4"	2-3/4"	2-1/2"	11/16"	3,600	1	08209	—
	.016									08219	—
12"	.014	2"◆	52	3/4"	2-3/4"	2-1/2"	11/16"	3,600	1	08200-14	—
12"	.020	1-1/4"★	56	5/8"	2-3/4"	3"	13/16"	4,500	2	09719	—
12"	.023	2"◆	66	3/4"	2-1/4"	3"	13/16"	5,000	2	09870	—

★ 5/16" x 5/32" Double Keyway

◆ 1/2" x 1/4" Double Keyway

▲ Available in non-sparking bronze wire, see page 92-93 for details.

■ Packaged product available. See pages 136-139 for details.



COATED ABRASIVES
NON-WOVEN ABRASIVES
NYLON BRUSHES

V WOLVERINE® STANDARD TWIST WHEELS provide aggressive brushing action for general-purpose surface cleaning applications.



Dia.	Wire Size	Arbor Hole	No. of Knots	Face Width	Trim Length	Max. AH Avail.	Thickness at Face Plates	Max. RPM	Std. Pack	Item Number	
										Steel	Stainless
3"	.014	1/2"-3/8"	20	3/8"	3/8"	1/2"	7/16"	25,000	10	36290	—
4"	.014	1/2"-3/8"	20	5/8"	7/8"	1/2"	9/16"	20,000	10	36226 •	—
			24							—	36293
6"	.014	5/8"-1/2"	24	1/2"	1-1/4"	5/8"	9/16"	9,000	10	36227	—
8"	.014	5/8"	34	9/16"	1-5/8"	5/8"	1/2"	6,000	2	36228 •	—
			38							36279	—

• Non-stock product, contact Customer Service for lead times

NOTE

If a different arbor hole is required (than listed in the tables) refer to Arbor Hole Table shown on Pg. 51.

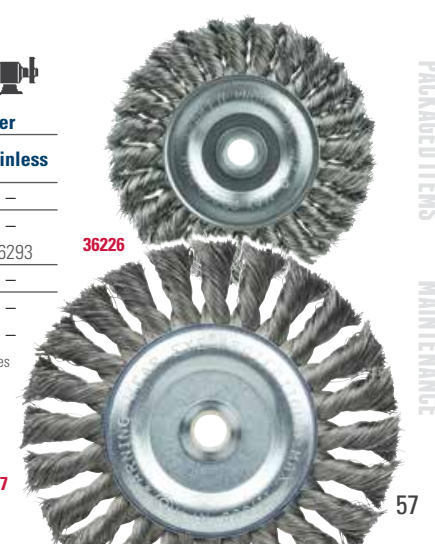

PACKAGED ITEMS
MAINTENANCE

36227



08339

P STANDARD TWIST WHEELS - High Density & Extra High Density - Engineered for maximum performance in production applications; for use on automated equipment such as dedicated gear deburring machines.

Diameter	Wire Size	Arbor Hole	Face Width	Trim Length	Thickness at Face Plates	Max. RPM	Standard Pack	Item Number
								Steel
80 KNOTS								
14"	.0118	1-1/4"★	3/4"	2-1/2"	5/8"	5,000	2	08309
	.0118	2"◆						08300
	.014	1-1/4"★						08319 •
	.014	2"◆						08310
	.020	1-1/4"★						08339
	.020	2"◆						08330 •
15"	.014	2"◆	3/4"	3"	5/8"	5,000	2	09980 •
	.020	2"◆						09990
90 KNOTS								
14"	.014	2"◆	3/4"	1-1/2"	5/8"	5,000	2	09020* •
	.016	2"◆						09790 •
	.016	1-1/4"★						09799
	.020	2"◆						09800 •
	.020	1-1/4"★						09809 •
	.020	1-1/4"★						09049* •
15"	.020	2"◆	3/4"	2"	5/8"	5,000	2	09840
	.020	2"◆						09080* •

★ 5/16" x 5/32" Double Keyway ◆ 1/2" x 1/4" Double Keyway * Economy • Non-stock product, contact Customer Service for lead times



09460

09104

P STANDARD TWIST WHEELS - Two Section - Provide heavy-duty brushing action with some flexibility; feature a double row of knotted wire for a wider brush face.



Diameter	Wire Size	Arbor Hole	No. of Knots	Face Width	Trim Length	Thickness at Face Plates	Max. RPM	Standard Pack	Item Number
									Steel
3"	.0118	1/2"-3/8"	40	3/4"	5/8"	3/4"	22,000	5	09104
4"	.0118	1/2"-3/8"	48	3/4"	7/8"	3/4"	20,000	5	09134
6"	.0118	2"	60	7/8"	1-3/8"	7/8"	8,000	5	09160
	.016								09180
8"	.0118	2"	76	1"	1-5/8"	1"	6,000	1	09410
	.016								09430
	.023								09440
10"	.0118	2"	104	1-1/4"	1-3/4"	1-1/4"	4,500	1	09460
	.016								09480
	.023								09490
12"	.0118	2"	104	1-1/4"	2-3/4"	1-1/4"	3,600	1	09510
	.016								09530
	.023								09540

See Metal Adapters on page 66 for brushes with 2" arbor holes.



94000

P STANDARD TWIST WHEEL - Four Section - Featuring four rows of knotted wire; for use in automated cleaning processes such as removing light mill scale from metal rod and wire.

Diameter	Wire Size	Arbor Hole	No. of Knots	Face Width	Trim Length	Thickness at Face Plates	Max. RPM	Standard Pack	Item Number
									Steel
12"	.014	2"	208	2"	2-3/4"	1-3/4"	3,600	1	94000

See Metal Adapters on page 66 for brushes with 2" arbor holes.

P **CABLE TWIST WHEELS** provide maximum brushing action with minimal flexibility; ideal for demanding cleaning and coating removal applications on relatively smooth surfaces.



Dia.	Wire Size	Arbor Hole	No. of Knots	Face Width	Trim Length	Max. AH Avail.	Thickness at Face Plates	Max. RPM	Std. Pack	Item Number	
										Steel	Stainless
4"	.020	1/2"-3/8"	24	1/4"	7/8"	1/2"	7/16"	20,000	10	08534 ■	—
6"	.023	5/8"-1/2"	24	3/8"	1-3/8"	1-1/4"	9/16"	9,000	10	08565 ■	08695 *
8"	.023	5/8"	38	1/2"	1-5/8"	2"	1/2"	6,000	2	08615	—
10"	.023	3/4"	52	1/2"	1-3/4"	2-1/2"	3/4"	4,500	2	08878	—
		1-1/4"★								08879	—
12"	.023	1-1/4"★	52	7/16"	2-3/4"	3"	3/4"	3,600	2	09379 ●	—

If a different arbor hole is required (than listed) refer to the Arbor Hole Variations Table on page 51.

★ 5/16" x 5/32" Double Keyway

*Standard Pack 2

■ Packaged product available. See pages 136-139 for details.

● Non-stock product, contact Customer Service for lead times

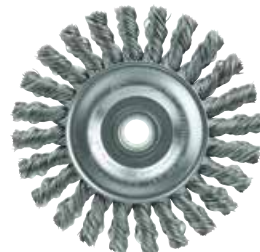

08534



94008

P **CABLE TWIST WHEEL - Four Section** - Featuring four rows of tightly knotted wire; for use in demanding automated applications such as cleaning the OD of drill pipe and other oilfield tubular goods.

Dia.	Wire Size	Arbor Hole	No. of Knots	Face Width	Trim Length	Max. AH Avail.	Thickness at Face Plates	Max. RPM	Std. Pack	Item Number
										Steel
10"	.023	2"	208	1-3/4"	1-3/4"	2"	1-7/8"	4,500	1	94008

P **JOINT & CRACK CLEANING WHEELS** feature heavy-duty construction and an extra long trim length for cleaning expansion joints and cracks in concrete and asphalt.



Dia.	Wire Size	Arbor Hole	No. of Knots	Face Width	Trim Length	Thickness at Face Plates	Max. RPM	Standard Pack	Item Number
									Steel
10"	.035	1" with two drive holes★	38	3/8"	2-5/8"	1/2"	5,000	2	94199 ●
12"	.035	1" with two drive holes★	38	3/8"	3-5/8"	1/2"	5,000	2	94224
12"	.035	1" with two drive holes★	52	3/8"	2-3/4"	3/4"	6,000	2	94026

*Drive holes are 3/8" diameter with 1/4" x 1/8" double keyway.

● Non-stock product, contact Customer Service for lead times

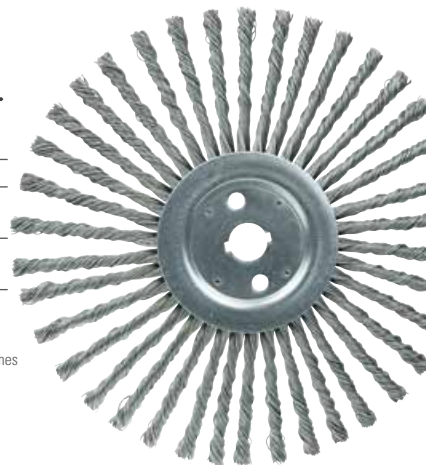

94224

ADAPTER for mounting Joint & Crack Cleaning Wheels onto a 20mm arbor.

For Brush Arbor Hole Size	Adapted Arbor Hole Size	Standard Pack	Item Number
1"	20mm	10	04455



04455

Cleaning a crack on an airport runway with a joint & crack cleaning brush prior to filling.



NOTE

If a different arbor hole is required (than listed in the tables) refer to Arbor Hole Table shown on Pg. 51.

Key:

P Performance line Industrial Grade

V Value line Professional Grade

WHY WEILER
BONDED ABRASIVES
COATED ABRASIVES

NYLON BRUSHES

PACKAGED ITEMS

MAINTENANCE

KNOT WIRE WHEELS WITH NUT



Cleaning a corner weld with a bevel brush.

MADE IN USA

Knot wire wheels with a threaded nut are intended for use primarily on small and large right angle grinders. Featuring Weiler's individual knot hole construction, these radial brushes are available in heat-treated steel, Type 302 stainless steel and bronze wire for use in a wide variety of applications.

APPLICATIONS

- Removing powder-coating, epoxy-based paints, and rubberized coatings
- Weld preparation and cleaning
- Cleaning scale and heavy corrosion
- Removing heavy burrs from large pieces after cutting

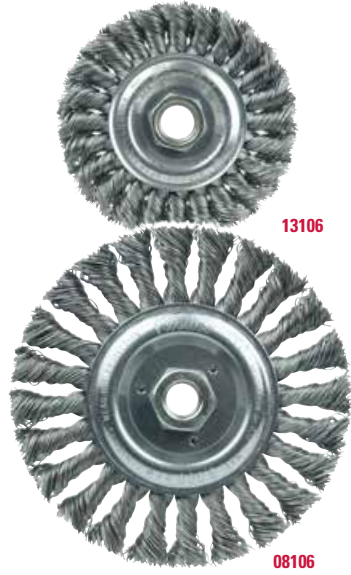

P STANDARD TWIST WHEELS provide heavy-duty brushing action with some flexibility; ideal for deburring and demanding cleaning applications on somewhat irregular surfaces.



Dia.	Wire Size	Arbor Hole	No. of Knots	Face Width	Trim Length	Max. RPM	Std. Pack	Item Number	
								Steel	Stainless
3"	.014	3/8"-24 UNF	20	3/8"	5/8"	25,000	5	13201	13208 •
4"	.014	M10 x 1.25	24	1/2"	7/8"	20,000	5	13100 •	13107 •
		M10 x 1.50						13101 •	13108 •
		M14 x 2.0						13102	13109 •
		3/8"-24 UNF						13103	13110
		1/2"-13 UNC						13105	—
5/8"-11 UNC	13106 ■	13113 ■							
4"	.020	M10 x 1.25	24	1/2"	7/8"	20,000	5	13114 •	—
		M10 x 1.50						13115 •	—
		M14 x 2.0						13116 •	—
		3/8"-24 UNF						13117	—
		1/2"-13 UNC						13119 •	—
		5/8"-11 UNC						13120 ▲ ■	—
6"	.016 .023	5/8"-11 UNC	24	1/2"	1-3/8"	9,000	2 5	—	08346
								08106	—

■ Packaged product available. See pages 136-139 for details.

▲ Available in non-sparking bronze wire, see page 92-93 for details.

• Non-stock product, contact Customer Service for lead times



36224

V WOLVERINE® STANDARD TWIST WHEELS provide an aggressive brushing action for general purpose deburring, cleaning, and surface preparation applications.



Dia.	Wire Size	Arbor Hole	No. of Knots	Face Width	Trim Length	Max. RPM	Std. Pack	Item Number	
								Steel	Stainless
4"	.014	5/8"-11 UNC	20	1/2"	7/8"	20,000	5	36212	36213
		M10 x 1.25						36215 •	—
		M10 x 1.50						36216 •	—
		M14 x 2.0						36217 •	—
6"	.025	5/8"-11 UNC	24	3/4"	1-1/4"	11,000	10	36224	—

• Non-stock product, contact Customer Service for lead times



13266

P CABLE TWIST WHEELS provide maximum brushing action with minimal flexibility; ideal for demanding cleaning and surface preparation applications on relatively smooth surfaces.



Dia.	Wire Size	Arbor Hole	No. of Knots	Face Width	Trim Length	Max. RPM	Std. Pack	Item Number	
								Steel	Stainless
4"	.020	M10 x 1.25	24	1/4"	7/8"	20,000	5	13261 •	—
		M10 x 1.50						—	13272 •
		5/8"-11 UNC						13266 ■	13276

■ Packaged product available. See pages 136-139 for details.

• Non-stock product, contact Customer Service for lead times



36255

V WOLVERINE CABLE TWIST WHEELS provide the most aggressive brushing action for general purpose cleaning and surface preparation applications.



Dia.	Wire Size	Arbor Hole	No. of Knots	Face Width	Trim Length	Max. RPM	Std. Pack	Item Number	
								Steel	Stainless
4"	.020	5/8"-11 UNC	20	1/4"	7/8"	20,000	5	36255	36257 •
		M10 x 1.50						36258 •	—
		M10 x 1.25						—	—

• Non-stock product, contact Customer Service for lead times

P **STANDARD TWIST BEVEL BRUSHES** are saucer-shaped radial wheels that provide a heavy-duty brushing action with some flexibility; ideal for cleaning fillet welds and into corners.



Diameter	Wire Size	Arbor Hole	No. of Knots	Face Width	Trim Length	Max. RPM	Std. Pack	Item Number	
								Steel	Stainless
4"	.014	M10 x 1.25	20	3/8"	3/4"	12,500	1	13401	—
		M10 x 1.50						13402	—
		5/8"-11 UNC						13406	13416
4"	.020	M14 x 2.0	20	3/8"	3/4"	12,500	1	13423	—
		5/8"-11 UNC						13426	13436
4-1/2"	.014	5/8"-11 UNC	20	3/8"	1"	12,500	1	13456	13466
4-1/2"	.020	5/8"-11 UNC	20	3/8"	1"	12,500	1	13476	13486

• Non-stock product, contact Customer Service for lead times



13456

P **THREADED ADAPTERS** for mounting brushes with a 5/8"-11 UNC nut to other threaded spindles.

Fixed Thread Size	Adapted Thread Size	Standard Pack	Item Number
5/8"-11 UNC	M10 x 1.25	10	07771 ■
5/8"-11 UNC	M10 x 1.50	10	07772 ■
5/8"-11 UNC	3/8"-16 UNC	10	07769
5/8"-11 UNC	3/8"-24 UNF	10	07746

■ Packaged product available. See pages 136-139 for details.



07771

KNOT WIRE WHEELS WITH STEM

MADE IN USA

Knot wire wheels with a permanently attached 1/4" stem or shank are primarily intended for use on high-speed die grinders. Although they can also be mounted onto a drill, the speed and power of that tool will limit the effectiveness of the brush. Featuring Weiler's individual knot hole construction, these radial wheels are available in heat-treated steel and Type 302 stainless steel wire.

APPLICATIONS

- Removing powder-coating, epoxy-based paints, and rubberized coatings
- Weld preparation and cleaning
- Cleaning scale and heavy corrosion
- Removing heavy burrs from large pieces after cutting

P **STANDARD TWIST WHEELS 1/4" Stem** - Provide heavy-duty brushing action with some flexibility; ideal for deburring and demanding cleaning applications on somewhat irregular surfaces.

Diameter	Wire Size	No. of Knots	Face Width	Trim Length	Max. RPM	Standard Pack	Item Number	
							Steel	Stainless
3-1/4"	.0118	20	3/8"	5/8"	25,000	5	17680	—
	.014						17681 ■	17684
	.020						17682	—
4"	.0118	24	1/2"	7/8"	20,000	5	17686	—
	.014						17687 ■	17691
	.020						17689	—

■ Packaged product available. See pages 136-139 for details.



17684

"We get a competitive edge with Weiler because their prices are competitive but they last far longer."

- **Jim Martin**, Vice President, Karnel Incorporated



Key:

P Performance line
Industrial Grade

V Value line
Professional Grade

WHY WEILER

BONDED ABRASIVES

COATED ABRASIVES

NON-WOVEN ABRASIVES

POWER BRUSHES

NYLON BRUSHES

PACKAGED ITEMS

MAINTENANCE

WELD CLEANING BRUSHES

Weiler's stringer bead wheels are the most effective weld cleaning tools for the most demanding users. Our premium weld cleaning brushes are manufactured to the most stringent quality standards, utilizing the highest quality wire available. The twist puts all the sharp tips at the end of the knots, making them the fastest, most aggressive weld cleaning tools on the market.



UP TO
2X
THE LIFE

ROUGHNECK[®] MAX

MADE IN
USA

Roughneck Max wheels have been re-engineered to MAXimize life, efficiency and consistency. But that is only a small part of what makes this brush better...

- **Smooth & Responsive** — Improved feel and comfort during use makes brush operation effortless
- **No Long Wire Breakage** — Stronger, sharper wire delivers consistency and performance you can count on
- **Cleans 40% Faster** — Unmatched cleaning power compared to competitors
- **Less Force Required** — The operator can apply less pressure to clean, letting the wire do the work

P **ROUGHNECK[®] MAX STRINGER BEAD WHEELS** deliver unmatched weld cleaning performance by maximizing life, efficiency and consistency. The 4" brushes are recommended for cleaning root pass welds, surface prep and other cleaning applications.



13131



13124

Diameter	Wire Size	Arbor Hole	No. of Knots	Face Width	Trim Length	Thickness at Face Plates	Max. RPM	Std. Pack	Item Number	
									Steel	Stainless
4"	.020	5/8"-11 UNC	32	3/16"	7/8"	7/16"	20,000	5	13131 ■	13138 ■

■ Packaged product available. See pages 136-139 for details.

ROUGHNECK[®]

MADE IN
USA

P **ROUGHNECK STRINGER BEAD WHEELS** are the standard for high-performance weld cleaning brushes. Narrow face brushes are suitable for cleaning root and hot passes and reaching into corners; wider face wheels can be used for cleaning filler and cap passes as well as for other surface prep and cleaning applications.



09000

08776

Diameter	Wire Size	Arbor Hole	No. of Knots	Face Width	Trim Length	Thickness at Face Plates	Max. RPM	Std. Pack	Item Number		
									Steel	Stainless	
Root Pass Brushes											
4"	.020	1/2"-3/8" M10 x 1.25 M10 x 1.50 M14 x 2.0 3/8"-24 UNF 1/2"-13 UNC	32	3/16"	7/8"	7/16"	20,000	5	13124	08954*	
									13125 ■	13132	
									13126	—	
									13127	13134	
									13128	13135	
									13130	13137	
4-1/2"	.020	5/8"-11 UNC 7/8"	38	3/16"	13/16"	3/8"	15,000	5	13232	13238	
									13234	13249	
5"	.020	5/8"-11 UNC 7/8"	38	3/16"	7/8"	3/8"	12,500	5	08756	08806	
									08750	—	
6"	.020	5/8"-11 UNC	48	3/16"	1-1/8"	3/8"	12,500	10	08766†	—	
			38		1-3/8"				—	08786†•	
			56		1-1/8"				7/16"	09400 ■	09500
			76		1-1/8"				7/16"	09000 ■	09200
7"	.020	5/8"-11 UNC	56	3/16"	1-1/8"	7/16"	9,000	10	09000 ■	09200	
									09100	—	
Filler Pass Brushes											
5"	.023	5/8"-11 UNC	24	1/2"	7/8"	3/8"	12,500	5	09856	09866	
6"	.023	5/8"-1/2"	24	1/2"	1-3/8"	9/16"	12,500	10	08775	—	
		5/8"-11 UNC	24		1-3/8"	9/16"			08776 ■	08796•	
		5/8"-11 UNC	30		1-1/4"	5/8"			08916	08926•	
		5/8"-11 UNC	30		1-3/8"	1/2"			09386	09396•	

† Light Duty • Standard Pack 5 * Standard Pack 10

■ Packaged product available. See pages 136-139 for details.

NOTE

If a different arbor hole is required (than listed in the tables) refer to Threaded Adapter Chart shown on Pg. 61.

THE DUALLY®



MADE IN USA

- **Maximum Cleaning Action** — Featuring a knot twist with the most aggressive cutting action, the new dual-hex nut makes it easier for the user to regularly switch mounting position and keep the brush running at peak performance.
- **Long Wheel Life** — Utilizing the highest quality heat-treated Steel wire and construction that virtually eliminates knot movement, the Dually delivers smooth operation and long life for the lowest cleaning costs in demanding multi-pass welding applications such as pipeline construction.
- **Improved User Safety** — The one-piece, dual-hex nut is designed to provide adequate tool clearance so there is no need to remove the guard from the grinder in order to change the position of the wheel.



Removing weld slag before the next weld pass.

P **DUALLY® STRINGER BEAD WHEELS** feature a dual-hex nut design that simplifies periodic flipping of the wheel for maximum cleaning action, long life, and safer use.

Diameter	Wire Size	Arbor Hole	No. of Knots	Face Width	Trim Length	Thickness at Face Plates	Max. RPM	Standard Pack	Item Number	
									Steel	Stainless
Root Pass Brushes										
4-1/2"	.020	5/8"-11 UNC	38	3/16"	13/16"	3/8"	15,000	5	79801	79811
5"	.020	5/8"-11 UNC	38	3/16"	7/8"	3/8"	12,500	5	79802	79812 •
6"	.020	5/8"-11 UNC	56	3/16"	1-1/8"	7/16"	12,500	5	79805	79815
7"	.020	5/8"-11 UNC	56	3/16"	1-1/8"	7/16"	9,000	5	79800	79810 •
Filler Pass Brushes										
5"	.023	5/8"-11 UNC	24	1/2"	7/8"	3/8"	12,500	5	79803	79813 •
6"	.023	5/8"-11 UNC	30	1/2"	1-1/4"	5/8"	12,500	5	79804	79814

• Non-stock product, contact Customer Service for lead times



79802

COATED ABRASIVES

P **POLYFLEX™ ENCAPSULATED WELD CLEANING WHEELS** Black Elastomer* Feature a heat-stabilized encapsulation that gradually wears away to expose a consistent short trim for higher aggression, controlled brushing action, and longer life; suitable for cleaning hot welds.

Diameter	Wire Size	Arbor Hole	No. of Knots	Face Width	Trim Length	Thickness at Face Plates	Max. RPM	Standard Pack	Item Number	
									Steel	
4"	.020	5/8"-11 UNC	32	3/16"	7/8"	7/16"	20,000	5	35800 ▲	
6"	.014	5/8"-11 UNC	—	3/16"	1-7/16"	3/8"	9,000	5	35206 ◆	
7"	.020	5/8"-11 UNC	56	3/16"	1-1/8"	7/16"	9,000	10	35600 ▲	35216 ◆
	.014									

* See Elastomer Color Code Chart on page 51 for more information. ▲ Stringer Bead Wheels ◆ Crimped wire



35800

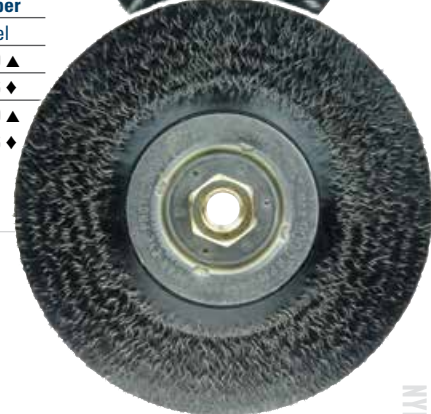

35216

NYLON BRUSHES

WOLVERINE®

Wolverine wheels offer professional grade quality and performance at a great value. Re-engineered, these 32 knot wheels deliver 20% MORE life while maintaining aggressive cleaning power for weld cleaning applications.

MADE IN USA

V **WOLVERINE® STRINGER BEAD WHEELS** have upgraded to 32 knots to deliver 20% longer life. The 4" wheels are manufactured using similar product construction and to the same exacting standards as other Weiler weld cleaning brushes; they have been engineered for cost-effective use in less demanding cleaning applications.

Diameter	Wire Size	Arbor Hole	No. of Knots	Face Width	Trim Length	Thickness at Face Plates	Max. RPM	Standard Pack	Item Number	
									Steel	Stainless
4"	.020	5/8"-11 UNC	32	3/16"	7/8"	7/16"	20,000	5	36218	36219



36218

PACKAGED ITEMS

V **WOLVERINE STRINGER BEAD WHEELS** are manufactured using similar product construction and to the same exacting standards as other Weiler weld cleaning brushes; they have been engineered for cost-effective use in less demanding applications.

Dia.	Wire Size	Arbor Hole	No. of Knots	Face Width	Trim Length	Max. RPM	Item Number	
							Steel	Stainless
5"	.020	5/8"-11 UNC	38	3/16"	7/8"	12,500	36295	36296
6"	.020	5/8"-11 UNC	48	1/4"	1-1/4"	12,500	36225	—
			38	3/16"	1-3/8"	36307†	—	
7"	.020	5/8"-11 UNC	56	3/16"	1-1/8"	9,000	36297	—

† Light Duty



36297

CRIMPED WIRE WHEELS WITH ARBOR HOLE

MADE IN
USA

Crimped Wire Wheels with Arbor Hole are intended for use on straight grinders and stationary machines such as bench or pedestal grinders and buffing lathes. Featuring Weiler's solid ring construction, these radial brushes are available in heat-treated steel, Type 302 stainless steel and brass wire for use in a wide variety of applications.

APPLICATIONS

- Removing rust and light corrosion
- Paint removal and surface cleaning
- Decorative finishing
- Removing heat discoloration
- Light deburring



Removing heat discoloration from a stainless steel canister.



NOTE

If a different arbor hole is required (than listed in the tables) refer to Arbor Hole Table shown on Pg. 51.

P **CRIMPED WIRE WHEELS - Narrow Face** - provide a flexible brushing action and consistent performance for demanding light-duty cleaning and deburring applications.



Dia.	Wire Size	Arbor Hole	Face Width	Trim Length	Max. AH Avail.	Thickness at Face Plates	Max. RPM	Std. Pack	Item Number	
									Steel	Stainless
3"	.006	1/2"-3/8"	7/16"	1/2"	3/4"	7/16"	12,500	2	00204	00244 •
	.008								00214	—
	.0118								00234	00264 •
	.014								00274	—
4"	.006	1/2"-3/8"	1/2"	7/8"	3/4"	7/16"	12,500	2	00104	00154
	.006								00105	—
	.008								00114	—
	.0095	5/8"-1/2"	1/2"-3/8"	—	—	—	—	—	00124	—
	.0118								00134	00184
	.0118								00135	—
.014	5/8"-1/2"	1/2"-3/8"	—	—	—	—	—	00144	—	
6"	.006	5/8"-1/2"	3/4"	1-7/16"	1-1/4"	7/16"	6,000	10	01035 ▲	01675*
	.008								01045	—
	.008	1-1/4" ★	5/8"-1/2"	—	—	—	—	—	01049	—
	.0104								01055	01695*
	.0118								01065 ▲	01705*
	.014								01075 ■	—
.0118	3/4"	3/4"	1-7/16"	1-1/4"	7/16"	6,000	10	01068	—	
8"	.006	5/8"	3/4"	2-1/16"	1-1/4"	1/2"	6,000	2	01135	01775
	.008								01145	—
	.0104								01155	01795
	.0118								01165	01805
	.014								01175 ■	—
	8"								.006	3/4"
.008		01148	—							
.0104		01158	—							
.0118		01168	—							
.014		01178	—							
8"	.0118	1-1/4" ★	3/4"	2-1/16"	1-1/4"	1/2"	6,000	2	—	01809
	.014								01179	—
	10"								.006	3/4"
.0104		01238	—							
.0118		01248	—							
.014		01258	01898							
.014		1" •	01250-12	—						
10"	.014	1-1/4" ★	3/4"	2-1/2"	2"	5/8"	4,000	2	01259	—
	12"								.006	1-1/4" ★
.0104		01309 •	01949 •							
.0118		01319	—							
.014		01329	—							
.014		2" ◆	3/4"	2-15/16"	2-1/2"	1/2"	3,000	2	01320-14 •	
15"	.0118	1-1/4" ★	3/4"	4-7/16"	2-1/2"	1/2"	3,000	2	01339 •	—
	.014								01349	—

◆ 1/2" x 1/4" Double Keyway

★ 5/16" x 5/32" Double Keyway

• 1/4" x 1/8" Double Keyway

▲ Available in non-sparking brass wire, see page 92-93 for details.

* Standard Pack 2

■ Packaged product available. See pages 136-139 for details.

• Non-stock product, contact Customer Service for lead times

V **WOLVERINE® CRIMPED WIRE WHEELS - Narrow Face** - provide a flexible brushing action and cost-effective performance in general purpose cleaning and deburring applications.

Dia.	Wire Size	Arbor Hole	Face Width	Trim Length	Max. AH Avail.	Max.RPM	Std. Pack	Item Number	
								Steel	Stainless
4"	.014	1/2"-3/8"	1/2"	3/4"	1/2"	6,000	2	36262	—
6"	.014	5/8"-1/2"	3/4"	1-1/4"	5/8"	6,000	2	36200	36201 •
8"	.014	5/8"	3/4"	2"	5/8"	6,000	2	36205	—

• Non-stock product, contact Customer Service for lead times



36205

35105

P **POLYFLEX™ ENCAPSULATED CRIMPED WIRE WHEELS** feature an encapsulation that gradually wears away to expose a consistent short trim for higher aggression, controlled brushing action, and longer life.

Dia.	Wire Size	Arbor Hole	Face Width	Trim Length	Max. AH Avail.	Thickness at Face Plates	Max. RPM	Standard Pack	Item Number Steel
Burgundy Elastomer* - Standard									
4"	.0095	1/2"-3/8"	3/8"	7/8"	3/4"	7/16"	6,000	2	35084
6"	.0104	5/8"-1/2"	1/2"	1-7/16"	1-1/4"	7/16"	6,000	2	35105
	.014								35117 •
8"	.014	5/8"	1/2"	2-1/16"	1-1/2"	1/2"	6,000	2	35135
Orange Elastomer* - Heavy-Duty									
6"	.0104	5/8"-1/2"	1/2"	1-7/16"	1-1/4"	7/16"	6,000	2	35520 •

* See Elastomer Color Code chart on page 51 for more information.

• Non-stock product, contact Customer Service for lead times



35520

P **BENCH GRINDER WHEELS** feature a shorter trim length, narrower face width, and the same durable construction as other Weiler crimped wire wheels; designed specifically for use on small bench grinders for reduced flaring and long life in a broad range of applications.

Dia.	Wire Size	Arbor Hole	Face Width	Trim Length	Max. AH Avail.	Thickness at Face Plates	Max. RPM	Standard Pack	Item Number Steel
6"	.006	5/8"-1/2"	1/2"	1-1/16"	1-1/4"	7/16"	6,000	10	01085
	.008								01095
	.0118								01115
	.014								01125



01115

P **CRIMPED WIRE WHEELS - High Density** - Feature an increased fill density for greater brushing action, more consistent performance, and longer life in the most demanding applications requiring the flexibility of a crimped wire wheel.

Dia.	Wire Size	Arbor Hole	Face Width	Trim Length	Max. AH Avail.	Thickness at Face Plates	Max. RPM	Std. Pack	Item Number	
									Steel	Stainless
4-1/4"	.0118	5/8"-1/2"	3/4"	5/8"	3/4"	9/16"	6,000	1	01501 •	—
	.014								01502 •	
6"	.008	5/8"-1/2"	3/4"	1-1/8"	1"	9/16"	6,000	1	01503 •	—
	.0118								01504 •	01508 •
	.014								01505 •	01509 •
	.020								01506 •	—
	01511								—	
7"	.014	5/8"	7/8"	1-5/8"	1"	9/16"	6,000	1	01511	—
8"	.006	5/8"	7/8"	1-1/2"	1-1/4"	11/16"	4,500	1	01512 •	—
	.0104								01513 •	—
	.0118								01514	—
	.014								01515	—
10"	.0118	3/4"	1"	2-1/2"	1-1/4"	11/16"	4,500	2	01517 •	—
	.014								01518 •	—

• Non-stock product, contact Customer Service for lead times



01501



01515

WHY WEILER

BONDED ABRASIVES

COATED ABRASIVES

NON-WOVEN ABRASIVES

POWER BRUSHES

NYLON BRUSHES

PACKAGED ITEMS

P

CRIMPED WIRE WHEELS - Medium Face - Provide a flexible brushing action and consistent performance for demanding light-duty cleaning and deburring applications; feature a wider face width to cover more area.



06020

06040

Dia.	Wire Size	Arbor Hole	Face Width	Trim Length	Thickness at Face Plates	Max. RPM	Standard Pack	Item Number	
								Steel	Stainless
4-1/2"	.0118	2"	15/16"	3/4"	7/8"	6,000	1	06020	—
6"	.006	2"	1"	1-1/8"	15/16"	6,000	1	06040	—
	.008							06050	—
	.0104							06060	06440
	.0118							06070	06450
	.014							06080	—
8"	.006	2"	1"	1-3/8"	1"	4,500	1	06090	—
	.0104							06100	—
	.0118							06110	06490
	.014							06120	—
	.020							06620	—
10"	.0118	2"◆	1-1/8"	2"	1"	3,600	1	06150	06530
	.014							06160	—
	.020							06170	—
12"	.0118	2"◆	1-1/4"	3"	1"	3,600	1	06180	—
	.014							06190	—
	.014							06200	—
	.020							06200	—

◆ 1/2" x 1/4" Double Keyway
For arbor hole reducing adapters, see Metal Adapter Table below.

V

WOLVERINE® CRIMPED WIRE WHEELS - Medium Face - Provide a flexible brushing action and cost-effective performance in general purpose cleaning and deburring applications; feature a wider face width to cover more area.



02335

Dia.	Wire Size	Arbor Hole	Face Width	Trim Length	Thickness at Face Plates	Max. RPM	Standard Pack	Item Number	
								Steel	Stainless
6"	.014	5/8"-1/2"	5/8"	1-1/16"	1/2"	6,000	1	02325	—
			3/4"	1-7/16"	7/16"			36203	—
7"	.014	5/8"	3/4"	1-9/16"	1/2"	6,000	1	02335	—

P

METAL ADAPTERS for Medium & Wide Face Brushes. Used in pairs & priced per pair.



03809

For Brush Arbor Hole Size	Adapted Arbor Hole Size	Item Number
2"	1/2"	03809
	5/8"	03810
	3/4"	03811
	7/8"	03824
	1"	03812
	1-1/4"	03813
	1-1/2"	03814

P

PLATER'S WIRE WHEELS feature a longer trim length and very small diameter fill material for producing fine satin and antique finishes on non-ferrous and precious metals.



22241

Dia.	Wire Size	Arbor Hole	Face Width	Trim Length	Number of Rows	Max. RPM	Std. Pack	Item Number	
								Brass*	Stainless
3"	.003	1/4"	1/2"	1"	2	6,000	12	22021	•
4"	.004	1/4"	1"	1-1/4"	4	4,000	5	22061	•
6"	.005	1/4"	1"	1-7/8"	4	3,600	1	22241	—

* Also available in carbon steel, stainless steel and nickel silver wire.

• Non-stock product, contact Customer Service for lead times

P

CRIMPED WIRE WHEELS - Wide Face - Provide a flexible brushing action and consistent performance for demanding light-duty cleaning and deburring applications; feature a wider face width to cover more area.



Dia.	Wire Size	Arbor Hole	Face Width	Trim Length	Thickness at Face Plates	Max. RPM	Standard Pack	Item Number	
								Steel	Stainless
4-1/2"	.006	2"	1-1/4"	3/4"	7/8"	6,000	1	03000 •	—
	.0118							03010 •	—
	.014							03020 •	—
6"	.006	2"	1-1/4"	1-1/8"	1"	6,000	1	03030	03480
	.008							03040	—
	.0104							03050	—
	.0118							03060	03510
	.014							03070	03520
7"	.0118	2"	1-1/4"	1-5/8"	1"	6,000	1	03090	—
	.014							03100	—
8"	.006	2"	1-1/2"	1-3/8"	1-3/8"	4,500	1	03110	—
	.0095							03130 •	—
	.0118							03140	03590 •
	.014							03150	—
	.020							03160	—
10"	.0104	2"	2"	1-7/8"	1-5/8"	4,000	1	03180	—
	.0118							03190	—
	.014							03200	—
	.020							03210	—
12"	.0118	2"	2"	2-7/8"	1-9/16"	3,000	1	03220	—
	.014							03230	03680
	.020							03240	—

For arbor hole reducing adapters, see Metal Adapter Table on page 66.

• Non-stock product, contact Customer Service for lead times



WHY WEILER

BONDED ABRASIVES

COATED ABRASIVES

NON-WOVEN ABRASIVES

V

WOLVERINE® CRIMPED WIRE WHEELS - Wide Face - Provide a flexible brushing action and cost-effective performance in general purpose cleaning and deburring applications; feature a wider face width to cover more area.



Dia.	Wire Size	Arbor Hole	Face Width	Trim Length	Thickness at Face Plates	Max. RPM	Standard Pack	Item Number	
								Steel	
6"	.014	2"-5/8"-1/2"	7/8"	1-1/8"	7/8"	6,000	1	06645	
								36204	
7"	.014	2"-5/8"-1/2"	7/8"	1-5/8"	7/8"	6,000	1	06655	
8"	.014	2"-5/8"	1"	1-3/8"	1"	4,000	1	36206	
10"	.014	2"-3/4"	1-1/8"	2"	1"	3,600	1	36265 •	

• Non-stock product, contact Customer Service for lead times



POWER BRUSHES

P

POLYFLEX™ ENCAPSULATED CRIMPED WIRE WHEEL - Wide Face - Burgundy*
Elastomer* - Features an encapsulation that gradually wears away to expose a consistent short trim for higher aggression, controlled brushing action, and longer life. Wider face width covers more area.



Dia.	Wire Size	Arbor Hole	Face Width	Trim Length	Thickness at Face Plates	Max. RPM	Std. Pack	Item Number	
								Steel	
6"	.0118	2"	1"	1-1/8"	1"	6,000	1	35160	

* See Elastomer Color Code Chart on page 51 for more information.
 For arbor hole reducing adapters, see Metal Adapter Table on page 66.



NYLON BRUSHES

PACKAGED ITEMS

MAINTENANCE

SMALL DIAMETER "COPPER CENTER" WHEELS



Removing casting flash from ductile-iron housing with an encapsulated brush.

**MADE IN
USA**

Weiler's small diameter crimped wire wheels feature a plain arbor hole for use on a variety of portable tools and stationary machines. Featuring Weiler's solid ring construction for high-speed use, these radial brushes are available in heat-treated steel, Type 302 stainless steel, and brass wire.

APPLICATIONS

- Removing carbon build-up and deposits
- Removing rust and light corrosion
- Cleaning and finishing ID's and recessed areas
- Cleaning boiler tubes and internal passages
- Cleaning threads
- Wire stripping
- Light deburring

P **SMALL DIAMETER WHEELS** provide a flexible brushing action and consistent performance for light-duty cleaning and deburring applications requiring a small wheel.



Dia.	Wire Size	Arbor Hole	Face Width	Trim Length	Max. RPM	Standard Pack	Item Number	
							Steel	Stainless
1"	.003	1/4"	3/16"	1/4"	20,000	10	—	16461
	.005						—	16471
	.006						15071	—
1-1/4"	.003	1/4"	1/4"	3/8"	20,000	10	15101 •	—
	.006						—	16511 •
	.008						—	16521
1-3/8"	.008	3/8"	1/4"	5/16"	20,000	10	15732	—
	.006						15131	—
	.008						15141	—
1-1/2"	.0104	1/4"	1/4"	7/16"	20,000	10	15151	—
	.006						15302 ▲	—
	.008						15312	16712
2"	.008	3/8"	3/8"	1/4"	20,000	10	15753 •	—
	.008	3/8"		7/16"			—	
	.0104	3/8"		7/16"			—	
	.0118	3/8"		7/16"			—	
	.014	3/8"		7/16"			—	
	.003	1/4"		3/4"			—	
	.003	1/2"		1/2"			99307	—
.005	1/2"	—	15863 •	—				
.006	1/2"	—	—	16833				
.008	1/2"	—	15433 ▲	—				
.0104	1/2"	—	15443	16843				
.0118	1/2"-3/8"	—	15453	16853				
.014	1/2"-3/8"	—	15463 ▲	—				
—	1/2"-3/8"	—	15473	16873				
2-1/2"	.0118	1/2"-3/8"	1/2"	3/4"	20,000	10	15513	—
	.014						15523	—
3"	.003	1/2"	5/8"	1"	20,000	10	99551	—
	.006	1/2"-3/8"		1"			15533	16933
	.006	5/8"		15/16"			—	
	.008	1/2"-3/8"		1"			15543	16943
	.008	5/8"		15/16"			15647 •	—
	.0104	1/2"		1"			15553	—
	.0118	1/2"-3/8"		1"			15563	16963
	.0118	5/8"		15/16"			15667 •	—
	.014	1/2"-3/8"		1"			15573 ▲	16973
	.014	5/8"		15/16"			15677	—
	4"	.006		1/2"			1/2"	1-1/2"

▲ Available in non-sparking brass wire, see page 92-93 for details.

• Non-stock product, contact Customer Service for lead times



P **POLYFLEX™ ENCAPSULATED SMALL DIAMETER WHEELS -**

Burgundy Elastomer* - Feature an encapsulation that gradually wears away to expose a consistent short trim for higher aggression, controlled brushing action, and longer life.



Diameter	Wire Size	Arbor Hole	Face Width	Trim Length	Max. RPM	Standard Pack	Item Number
							Steel
1-1/4"	.008	3/8"	3/16"	5/16"	20,000	10	35293
	.014						35294 •
2"	.0104	1/2"	1/4"	1/2"	20,000	10	35240
	.014						35070
3"	.008	1/2"	1/4"	1"	20,000	10	35808 •
	.0118						35250
	.014						35260

* See Elastomer Color Code chart on page 51 for more information.

• Non-stock product, contact Customer Service for lead times



WIRE STRIPPING BRUSHES

Used for removing insulation from electrical wire. These brushes are made to order according to the specifications needed for the specific application.

When ordering, please specify:

- Brush diameter
- Brush face width
- Arbor hole size
- Wire size

For application assistance, call our Application Engineering Hotline toll-free at: 888-299-APPS (2777)



NOTE

- The adapters and drive arbors listed on this page are for use with small diameter wheel brushes only; do not attempt to use them with cutting or grinding wheels, buffing wheels, or any type of abrasive wheel or disc.
- Do not adapt a wheel brush for use on a shaft diameter less than that specified by ANSI B165.1 (see page 55) or exceed the maximum wheel diameter specified for a drive arbor.
- Never mount a drive arbor onto a tool that operates above the maximum RPM rating of either the arbor or the brush (whichever may be lower) and be sure that the stem of the arbor is properly secured in the collet or chuck before use.

P **DRIVE ARBORS** for mounting small diameter wheels into a collet or chuck.



Arbor Dia.	Stem Dia.	Stem Length	Length of Shaft	For Brushes with a Max. Dia. of	Overall Length	Max. RPM	Standard Pack	Item Number
Unthreaded Shaft								
1/4"	1/4"	1-1/8"	3/16"	2"	2-1/16"	20,000	5	07723
3/8"	1/4"	1-1/8"	3/16"	4"	1-15/16"	20,000	5	07722
Threaded Shaft								
1/4"	1/4"	1-1/16"	1-1/8"	2"	2-9/16"	20,000	5	07725
3/8"	1/4"	3/4"	3/4"	3"	1-9/16"	25,000	5	07727
3/8"	1/4"	1"	1-1/8"	3"	2-9/16"	20,000	5	07726
1/2"	1/4"	3/4"	3/4"	3"	1-3/4"	25,000	5	07724
1/2"	1/4"	7/8"	3/4"	3"	1-11/16"	20,000	5	07721
5/8"	1/4"	3/4"	3/4"	3"	1-13/16"	25,000	5	07729



P **PLASTIC ADAPTERS** for mounting small diameter wheels onto various arbor sizes.

Fixed Arbor Hole Size	Adapted Arbor Hole Size	Standard Pack	Item Number
3/8"	1/4"	10	04403 •
1/2"	1/4"	10	04400
1/2"	3/8"	10	04401
5/8"	1/2"	10	04402

• Non-stock product, contact Customer Service for lead times



WHY WEILER BONDED ABRASIVES COATED ABRASIVES NON-WOVEN ABRASIVES POWER BRUSHES NYLON BRUSHES PACKAGED ITEMS MAINTENANCE

CRIMPED WIRE WHEELS WITH NUT OR STEM

MADE IN USA

Crimped wire wheels with a threaded nut are intended for use primarily on small angle grinders. Featuring Weiler's solid ring construction, these radial brushes are available in heat-treated steel and Type 302 stainless steel wire.

APPLICATIONS

- Removing rust and light corrosion
- Surface prep prior to welding
- Removing heat discoloration and welding residuals



Removing flash from a sand-cast iron engine block.

P

CRIMPED WIRE WHEELS provide a flexible brushing action and consistent performance for demanding light-duty cleaning and deburring applications.



Dia.	Wire Size	Arbor Hole	Face Width	Trim Length	Max. RPM	Std. Pack	Item Number	
							Steel	Stainless
4"	.006	5/8"-11 UNC	1/2"	7/8"	14,000	5	—	00156
4"	.014	M14 x 2.0	1/2"	7/8"	14,000	5	13077 •	—
		3/8"-24 UNF					13078 •	—
		5/8"-11 UNC					13081	13085
4"	.014	5/8"-11 UNC	1/2"	7/8"	14,000	5	35416*	—

* Polyflex™ encapsulated - Burgundy elastomer. See Elastomer Color Code Chart on page 51 for more information.

- Non-stock product, contact Customer Service for lead times

V

WOLVERINE® CRIMPED WIRE WHEEL provides a flexible brushing action and cost-effective performance in general purpose cleaning and deburring applications.



Diameter	Wire Size	Arbor Hole	Face Width	Trim Length	Max. RPM	Standard Pack	Item Number
							Steel
4"	.014	5/8"-11 UNC	1/2"	3/4"	14,000	5	36207 •

- Non-stock product, contact Customer Service for lead times



13085



36207

Crimped wire wheels with a permanently attached 1/4" stem or shank are primarily intended for use on high-speed die grinders. Although they can also be mounted onto a drill, the speed and power of that tool will limit the effectiveness of the brush. Featuring Weiler's solid ring construction, these radial wheels are available in heat-treated steel, Type 302 stainless steel, and brass wire.

APPLICATIONS

- Cleaning and finishing ID's and recessed areas
- Paint removal and surface cleaning
- Cleaning threads
- Light deburring

P

CONFLEX BRUSHES Narrow Face - 1/4" Stem - Provide a very flexible brushing action.



Diameter	Wire Size	Face Width	Trim Length	Max. RPM	Standard Pack	Item Number	
						Steel	Stainless
2"	.006	3/8"	1/2"	20,000	10	17609	—
	.0118					17610 ■	17611 ■
2-1/2"	.006	3/8"	3/4"	20,000	10	17612	—
	.014					17614	—
3"	.008	1/2"	1"	20,000	10	17615 ■	—
	.0118					17616 ▲ ■	—
	.014					17617	17618 ■

■ Packaged product available. See pages 136-139 for details.

▲ Available in non-sparking brass wire, see page 92-93 for details.



17616

P

POLYFLEX™ ENCAPSULATED CONFLEX BRUSHES - Burgundy Elastomer* - 1/4" Stem - Feature an encapsulation that gradually wears away to expose a consistent short trim for higher aggression, controlled brushing action, and longer life.



Diameter	Wire Size	Face Width	Trim Length	Max. RPM	Standard Pack	Item Number
						Steel
2"	.0118	1/4"	1/2"	20,000	10	35305
3"	.008	1/4"	1"	20,000	10	35310
	.0118					35315

* See Elastomer Color Code Chart on page 51 for more information.



35310

P

CONFLEX BRUSHES - Wide Face - 1/4" Stem - Provide a flexible brushing action and consistent performance for demanding light-duty cleaning and deburring applications; feature a wider face width to cover more area.



Diameter	Wire Size	Face Width	Trim Length	Max. RPM	Standard Pack	Item Number	
						Steel	Stainless
1-1/4"	.006	1/2"	3/8"	20,000	10	17600	—
	.008					17601	—
	.0118					17602	—
1-1/2"	.006	1/2"	1/2"	20,000	10	17603	—
	.008					17604	—
	.0118					—	—
1-3/4"	.006	1/2"	5/8"	20,000	10	17605	—
.008	—					17608	
2"	.0118	3/4"	7/16"	20,000	10	17619	—
2-1/2"	.014	3/4"	11/16"	20,000	10	17620	—
3"	.008	1"	15/16"	20,000	10	17621	17637
	.0118					—	—
	.014					17623	—



17603

P

CRIMPED WIRE RADIAL WHEELS 1/4" Stem - Feature side plates for a shorter trim length and more controlled brushing action in a stem-mounted crimped wire wheel.



Diameter	Wire Size	Face Width	Trim Length	Max. RPM	Standard Pack	Item Number	
						Steel	Stainless
1-1/2"	.006	1/4"	3/8"	20,000	10	17950	17971
	.008					17951	17972 •
	.0118					17952 •	17973
	.014					17953	—
						—	—
2"	.006	3/8"	7/16"	20,000	10	17954	—
	.008					17955	17974
	.0118					17956	—
	.014					17957	17975
	.020					17958 •	—
2-1/2"	.008	7/16"	9/16"	20,000	10	17959	17976 •
	.0118					17961	—
	.014					17962	17977 •
	.020					17963 •	—
						—	—
3"	.008	1/2"	13/16"	20,000	10	17964	17978
	.0118					17965	—
	.014					17966	17979
	.020					17967	—
						—	—
4"	.008	9/16"	1-5/16"	15,000	10	17968	17981
	.014					17969	17982
						—	—



17971



17978

• Non-stock product, contact Customer Service for lead times

V

WOLVERINE® CRIMPED WIRE RADIAL WHEELS 1/4" Stem - Designed to be a flexible and economic small diameter brushing tool for a broad range of general purpose applications.



Diameter	Wire Size	Face Width	Trim Length	Max. RPM	Standard Pack	Item Number	
						Steel	Stainless
1-1/2"	.0118	1/4"	3/8"	20,000	10	36208*	—
2"	.014	3/8"	7/16"	20,000	10	36209*	—
3"	.008	7/16"	13/16"	20,000	10	36259*	—
	.014					36211*	—

* Globally sourced products



36211

P

CONCAVE BRUSHES 1/4" Stem - Saucer-shaped radial wheels provide flexible brushing action for addressing corners and hard-to-reach areas.



Diameter	Wire Size	Face Width	Trim Length	Max. RPM	Standard Pack	Item Number	
						Steel	Stainless
1-1/2"	.006	1/4"	3/8"	20,000	10	17901	17930
	.008					17902	—
	.0118					17903	17931 •
2"	.008	3/8"	1/2"	20,000	10	17906	—
	.014					17907	17933
						—	—
2-1/2"	.006	7/16"	5/8"	20,000	10	17909	—
	.014					17912	17935
						—	—
3"	.006	1/2"	15/16"	20,000	10	17914	17936
	.008					17915	—
	.014					17917	17937
						—	—
4"	.008	9/16"	1-1/4"	20,000	10	17922	—
	.014					17923	—



17907

• Non-stock product, contact Customer Service for lead times

WHY WEILER

BONDED ABRASIVES

COATED ABRASIVES

NON-WOVEN ABRASIVES

POWER BRUSHES

NYLON BRUSHES

PACKAGED ITEMS

MAINTENANCE

NYLON AND TAMPICO WHEELS

MADE IN
USA



Deburring a plastic part using a nylon brush.

NYLON WHEELS

Wheel brushes filled with non-metallic filaments are primarily intended for light-duty surface cleaning and scrubbing applications as well as scratch-free finishing and polishing. Synthetic filaments such as nylon are durable and provide a very flexible brushing action in applications requiring less aggression than a wire brush. The softer fill material allows them to be used on materials that a wire brush would scratch or gouge.

APPLICATIONS

- Wet or dry cleaning and scrubbing
- Removing burrs and die flash from plastic parts
- Sweeping loose chips and debris



P **NYLON WHEELS** feature a chemical-resistant synthetic fill material with excellent bend recovery for use in applications requiring a soft, durable fill material.



Diameter	Fill Diameter	Arbor Hole	Face Width	Trim Length	Max. RPM	Standard Pack	Item Number
2"	.010	1/2"	3/8"	1/2"	20,000	10	17223
	.014						17233
2-1/2"	.022	5/8"	3/8"	11/16"	20,000	10	99346
3"	.010	1/2"	3/8"	1"	20,000	10	29070
	.016						17263
6"	.016	2"	3/4"	1-1/2"	6,000	2	20490
8"	.020	2"	3/4"	2-1/2"	5,000	2	20510 •

For arbor hole reducing adapters, see Metal Adapter Table below and plastic adapters on page 69.

• Non-stock product, contact Customer Service for lead times

TAMPICO WHEELS

MADE IN
USA

Wheel brushes filled with non-metallic filaments are primarily intended for light-duty surface cleaning and scrubbing applications as well as scratch-free finishing and polishing. Natural vegetable fibers such as Tampico hold abrasive compounds well and can be used for deburring, edge blending, and polishing applications.

APPLICATIONS

- Wet or dry cleaning and scrubbing
- Buffing and polishing non-ferrous and precious metals
- Removing burrs and blending edges with abrasive compounds

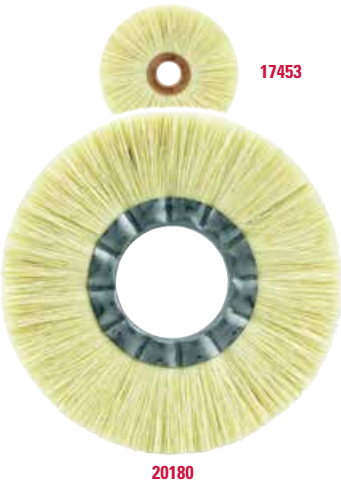

P **TAMPICO WHEELS** feature a durable vegetable fiber fill material that is chemical and heat resistant and also holds abrasive compounds well.



Diameter	Arbor Hole	Face Width	Trim Length	Max. RPM	Standard Pack	Item Number
2-1/2"	1/2"	1/2"	3/4"	20,000	10	17443
3"	1/2"	1/2"	1"	20,000	10	17453
6"	2"	5/8"	1-1/2"	6,000	10	20180
8"	2"	5/8"	2-1/2"	5,000	5	20190

For arbor hole reducing adapters, see Metal Adapter Table below and plastic adapters on page 69.

P **METAL ADAPTERS** for 6" & 8" Brushes. Used in pairs & priced per pair.



For Brush Arbor Hole Size	Adapted Arbor Hole Size	Standard Pack	Item Number
2"	1/2"	1 pair	03809
	5/8"	1 pair	03810
	3/4"	1 pair	03811
	7/8"	1 pair	03824
	1"	1 pair	03812
	1-1/4"	1 pair	03813
	1-1/2"	1 pair	03814

KNOT WIRE CUP BRUSHES

Cup brushes are for use on portable power tools for addressing larger surface areas more efficiently than a wheel brush. Cup brushes featuring a threaded nut are designed for smooth, efficient operation on angle grinders to make quick work of large jobs. Utility cup brushes featuring a permanently-attached 1/4" stem are more suitable for smaller jobs and are recommended for use on high-speed air tools for the most effective brushing action and longest life. Cup brushes are manufactured with individual knot hole and solid ring construction for high performance and long life.

APPLICATIONS

- Removal of slag from the edges of plasma or flame-cut plates
- Removing paint and coatings
- Cleaning rust, scale, and corrosion
- Deburring
- Weld prep and cleaning

CUP BRUSH SIZE SELECTION GUIDE

Brush Sizes	Angle Grinder Size
2-3/4" & 3"	4"
2-3/4", 3" & 3-1/2"	4-1/2"
2-3/4", 3" & 3-1/2"	5"
3-1/2" & 4"	6"
4", 5" & 6"	7"
4", 5" & 6"	9"

MADE IN
USA

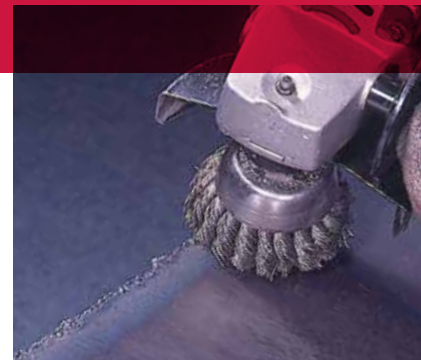

Removing slag from a flame-cut steel plate.

P **KNOT WIRE CUP BRUSHES - Single Row** - Provide heavy-duty brushing action with some flexibility; ideal for demanding cleaning applications on relatively flat surfaces.



Diameter	Wire Size	Arbor Hole	Trim Length	Max. RPM	Standard Pack	Item Number		
						Steel	Stainless	
2-3/4"	.014	M10 x 1.25	1"	14,000	1	13015	—	
		M10 x 1.50				13016 •	—	
		M14 x 2.0				13020	—	
		3/8"-24 UNF				13021	—	
		5/8"-11 UNC				13025 ■	13009	
2-3/4"	.020	M10 x 1.25	1"	14,000	1	13281 ■	13253	
		M10 x 1.50				13282	13254 •	
		M14 x 2.0				13283	13255	
		3/8"-24 UNF				13284	13256	
		1/2"-13 UNC				13285	13257	
5/8"-11 UNC	13286 ▲ ■	13258 ■						
3-1/2"	.023	M10 x 1.25	7/8"	13,300	1	13150	—	
		M10 x 1.50				13151	—	
		M14 x 2.0				13152	13159 •	
		3/8"-24 UNF				13153	13160	
		1/2"-13 UNC				13155	—	
5/8"-11 UNC	13156 ■	13163 ■						
3-1/2"	.014	5/8"-11 UNC	1-1/4"	9,000	1	12736	—	
						.020	12746	—
4"	.014	5/8"-11 UNC	1-1/4"	10,200	1	12306 ▲	12406	
						.023	12316 ■	12416
						.035	12326	—
4"	.023	5/8"-11 UNC	1-1/4"	10,200	1	12206 ❖	—	
						.023	12826*	—
5"	.014	5/8"-11 UNC	1-3/8"	7,000	1	12256*	—	
						.023	12276 ■*	—
6"	.014	5/8"-11 UNC	1-3/8"	6,600	1	12356 ■	12456	
						.023	12376 ■	12476
						.035	12396	—
6"	.023	5/8"-11 UNC	1-3/8"	6,600	1	12816*	—	
6"	.014	5/8"-11 UNC	1-5/8"	6,000	1	12846	—	
						.023	12856	12886
						.035	12866	—

* With internal nut ❖ Cable Twist ■ Packaged product available. See pages 136-139 for details. • Non-stock product, contact Customer Service for lead times
▲ Available in non-sparking bronze wire, see page 92-93 for details.



13021



13156



12316



12276



13711

NOTE

If a different arbor hole is required (than listed in the tables) refer to Threaded Adapter Chart shown on Pg. 61.

P **KNOT WIRE CUP BRUSHES - Hurricane Twist** - Very smooth brushing action and extended life with reduced cleaning action.



Diameter	Wire Size	Arbor Hole	Trim Length	Max. RPM	Standard Pack	Item Number
						Steel
2-3/4"	.014	M10 x 1.25	3/4"	14,000	1	13715 •
		M10 x 1.50				13716 •
		M14 x 2.0				13717 •
		5/8"-11 UNC				13718
2-3/4"	.020	M10 x 1.25	3/4"	14,000	1	13709 •
		M10 x 1.50				13710 •
		M14 x 2.0				13711 •
		5/8"-11 UNC				13712

• Non-stock product, contact Customer Service for lead times

COATED ABRASIVES

NON-WOVEN ABRASIVES

POWER BRUSHES

NYLON BRUSHES

PACKAGED ITEMS

MAINTENANCE



V

WOLVERINE® KNOT WIRE CUP BRUSHES - Single Row

Provide an aggressive brushing action for general-purpose surface cleaning applications.



Dia.	Wire Size	Arbor Hole	Trim Length	Max. RPM	Standard Pack	Item Number	
						Steel	Stainless
3"	.020	5/8"-11 UNC	1"	14,000	1	36238	36239
4"	.025	5/8"-11 UNC	1-1/4"	10,200	1	36244	—
6"	.025	5/8"-11 UNC	1-3/8"	6,600	1	36245	—



P

KNOT WIRE CUP BRUSHES - Banded - Single Row - Feature a removable metal band around fill material to reduce the exposed trim length and limit brush flaring at operating speed to provide a very aggressive, controlled brushing action.



Diameter	Wire Size	Arbor Hole	Trim Length	Max. RPM	Standard Pack	Item Number	
						Steel	Stainless
2-3/4"	.014	5/8"-11 UNC	5/8"	12,500	1	13300	—
	.020					13301	13302
4"	.023	5/8"-11 UNC	7/8"	10,200	1	12301	—
5"	.023	5/8"-11 UNC	7/8"	6,600	1	12120	—



P

KNOT WIRE CUP BRUSH - 1-1/2 Rows - Features an internal nut for use on dedicated equipment such as line traveling machines that clean and prep OD of pipe prior to coating.



Diameter	Wire Size	Arbor Hole	Trim Length	Max. RPM	Standard Pack	Item Number
						Steel
4"	.023	5/8"-11 UNC	1-1/4"	7,000	1	94012



P

KNOT WIRE CUP BRUSHES - Double Row - Provide very aggressive brushing while still maintaining some flexibility; ideal for severe cleaning applications.



Diameter	Wire Size	Arbor Hole	Trim Length	Max. RPM	Standard Pack	Item Number	
						Steel	Stainless
4"	.014	5/8"-11 UNC	1-1/4"	9,000	1	12756	—
	.020					12766	12726
	.023					12536	—
6"	.014	5/8"-11 UNC	1-3/8"	6,600	1	12556	12636
	.023					12576	—
	.035					12906	—
6"	.014	5/8"-11 UNC	1-1/2"	6,000	1	12916	—
	.023					12916	—
	.035					12926	—

• Non-stock product, contact Customer Service for lead times



P

KNOT WIRE CUP BRUSHES - Banded - Double Row - Feature a removable metal band around fill material to reduce the exposed trim length and limit brush flaring to provide an extremely aggressive, controlled brushing action for the most severe applications.



Diameter	Wire Size	Arbor Hole	Trim Length	Max. RPM	Standard Pack	Item Number
						Steel
4"	.020	5/8"-11 UNC	7/8"	9,000	1	12796
6"	.023	5/8"-11 UNC	7/8"	6,600	1	12676
	.035					12686



P

POLYFLEX™ ENCAPSULATED CRIMPED WIRE CUP BRUSHES feature fill material that has been encapsulated in an elastomer that gradually wears away to keep only the wire tips exposed; ideal for applications on flat surfaces that require maximum aggression but no flexibility in the brushing action.



Diameter	Wire Size	Arbor Hole	Trim Length	Max. RPM	Standard Pack	Item Number
						Steel
Burgundy Elastomer* - Standard						
3-1/2"	.014	5/8"-11 UNC	7/8"	12,000	1	35406
4"	.020	5/8"-11 UNC	1-1/8"	9,000	1	35186
6"	.020	5/8"-11 UNC	1-1/4"	6,000	1	35006
Orange Elastomer* - Heavy-Duty						
6"	.020	5/8"-11 UNC	1-1/4"	6,000	1	35530 ▲
Black Elastomer* - Heavy-Duty - Heat-Resistant						
6"	.020	5/8"-11 UNC	1-1/4"	6,000	1	35760 ▲ •

* See Elastomer Color Code Chart on page 51 for more information.

• Non-stock product, contact Customer Service for lead times

▲ With internal nut

P **CRIMPED WIRE CUP BRUSHES** provide very flexible brushing action and the most consistent performance for demanding light-duty cleaning applications; feature a threaded nut for use on angle grinders.



Diameter	Wire Size	Arbor Hole	Trim Length	Max. RPM	Standard Pack	Item Number	
						Steel	Stainless
3"	.014	M10 x 1.25	1"	14,000	1	13240 ■▲	—
		M10 x 1.50				13241	—
		M14 x 2.0				13242	—
		3/8"-24 UNF				13243	—
		1/2"-13 UNC				13244	—
		5/8"-11 UNC				13245 ■	—
3-1/2"	.014	M10 x 1.25	7/8"	13,300	1	13175	13182
		M10 x 1.50				13176 •	—
		M14 x 2.0				13177 •	13184 •
		3/8"-24 UNF				13178	13185
		1/2"-13 UNC				—	13187 •
		5/8"-11 UNC				13181 ■	13188
4"	.0118	5/8"-11 UNC	1-3/8"	10,200	1	14016	—
	.014					14026 ■	—
	.020					14036 ■▲	14126
5"	.014	5/8"-11 UNC	1-1/4"	9,000	1	14206 ■▲	—
	.020					14216	14256
6"	.014	5/8"-11 UNC	1-1/4"	6,600	1	14066 ■*	—
	.020					14076 ■▲*	14166*

* With internal nut ▲ Available in non-sparking brass & bronze wire, see page 92-93 for details. ■ Packaged product available. See pages 136-139 for details. • Non-stock product, contact Customer Service for lead times



Removing paint from a steel surface with a crimped wire cup brush.



13245



36237

NOTE

If a different arbor hole is required (than listed in the tables) refer to Threaded Adapter Chart shown on Pg. 61.

V **WOLVERINE® CRIMPED WIRE CUP BRUSHES** provide flexible brushing action and cost-effective performance in general purpose cleaning applications.



Diameter	Wire Size	Arbor Hole	Trim Length	Max. RPM	Standard Pack	Item Number
						Steel
3"	.014	5/8"-11 UNC	1"	14,000	1	36231
		1/2"-13 UNC				36232 •
4"	.020	5/8"-11 UNC	1-1/8"	9,000	1	36236
6"	.020	5/8"-11 UNC	1-1/2"	6,600	1	36237 *

* With internal nut • Non-stock product, contact Customer Service for lead times

CUP BRUSHES WITH STEM

Designed primarily for use on high speed die grinders, cup brushes with permanently attached stems can also be used on drills.



P **UTILITY CRIMPED WIRE CUP BRUSHES** are smaller diameter cup brushes which provide flexible brushing action and consistent performance for more demanding light-duty cleaning applications; featuring a 1/4" stem for use on air tools.



Diameter	Wire Size	Trim Length	Overall Length	Max. RPM	Standard Pack	Item Number	
						Steel	Stainless
1-3/4"	.006 .0118	3/4"	2-5/16"	13,000	10	14300 ▲	14303 •
						14301 ▲■	14304
2"	.008 .0118	5/8"	2-7/8"	13,000	10	14313 •	14318 •
						14306	14319 •
2-1/2"	.008 .014	7/8"	3-1/8"	13,000	10	14315 •	14320 •
						14317	14321 •
2-3/4"	.0118	7/8"	2-1/2"	6,000	1	14302 ■▲	—

■ Packaged product available. See pages 136-139 for details. ▲ Available in non-sparking brass wire, see page 92-93 for details. • Non-stock product, contact Customer Service for lead times



14301



36230

V **WOLVERINE UTILITY CRIMPED WIRE CUP BRUSH** is a flexible and economic small diameter brushing tool for a broad range of general purpose applications using air tools or drills. 1/4" Stem.



Diameter	Wire Size	Trim Length	Overall Length	Max. RPM	Standard Pack	Item Number
3"	.014	1"	3-1/4"	13,000	1	36230

COATED ABRASIVES
NON-WOVEN ABRASIVES
POWER BRUSHES
NYLON BRUSHES
PACKAGED ITEMS
MAINTENANCE

STEM-MOUNTED END BRUSHES



Cleaning hard-to-reach fillet welds on a gusseted base plate.

Wire end brushes are for use on high-speed portable power tools for addressing smaller surfaces and recessed areas. End brushes feature an integral 1/4" steel stem for safe operation at high speed and quick mounting into the collet or chuck of either electric or pneumatic die grinders.

End brushes are available in a variety of knot wire and crimped wire configurations for use in a broad range of applications, and they are manufactured with the highest quality construction for smooth, efficient performance and long life. Weiler's end brushes are available in heat-treated steel, Type 302 stainless steel, and bronze or brass wire.

APPLICATIONS

- Cleaning ID's, internal passages and recessed areas
- Deburbing internal edges and crosshole intersections
- Removal of die flash and excess molded material
- Spot facing

MADE IN
USA

P

KNOT WIRE END BRUSHES feature a hollow end and heavy-duty brushing action with some flexibility; ideal for more demanding cleaning applications in recessed areas.



10026

Diameter	Wire Size	Trim Length	Overall Length	Max. RPM	Standard Pack	Item Number	
						Steel	Stainless
1/2"	.006	1-1/8"	2-7/8"	20,000	10	-	10215 *
	.0104					10208	10216
	.014					10217	10218
3/4"	.006	1-1/8"	2-7/8"	20,000	10	-	10220 *
	.0104					10210	10211
	.014	7/8"	2-5/8"	22,000	10025 ■	10029 ■	
	.020				10026 ■	10030	
1-1/8"	.006	1-1/8"	2-9/16"	20,000	10	10141 ■ *	10142 • *
	.0104					10212	10213
	.0118	7/8"	2-5/8"	22,000	10187	-	
	.014				10027 ■	10031 ■	
	.020				10028 ▲ ■	10032	

• Coated cup ■ Packaged product available. See pages 136-139 for details. ▲ Available in non-sparking bronze wire, see page 92-93 for details.

* Globally sourced product

P

KNOT WIRE END BRUSHES - Nickel-plated Cup compliant with DOD MIL STD 2041D(SH)

Feature a hollow end and heavy-duty brushing action with some flexibility; ideal for more demanding cleaning applications in recessed areas.



10392

Diameter	Wire Size	Trim Length	Overall Length	Max. RPM	Standard Pack	Item Number	
						Steel	Stainless
3/4"	.014	7/8"	2-5/8"	22,000	10	10387 •	
	.020					10388 •	
1-1/8"	.014	7/8"	2-5/8"	22,000	10	10392	
	.020					10393 •	

• Non-stock product, contact Customer Service for lead times

V

WOLVERINE® KNOT WIRE END BRUSHES feature similar hollow-end construction and heavy-duty brushing action, but they have been engineered to provide cost-effective use for less demanding applications.



36251

Diameter	Wire Size	Trim Length	Overall Length	Max. RPM	Standard Pack	Item Number	
						Steel	Stainless
3/4"	.014	7/8"	2-5/8"	22,000	10	36286	36287 •
	.020		2-9/16"			36250	-
1"	.014	7/8"	2-5/8"	22,000	10	36288	36289
	.020		2-9/16"			36251	-

• Non-stock product, contact Customer Service for lead times

P

KNOT WIRE END BRUSHES - Banded - Feature a pair of bands around the fill to reduce the exposed trim length and limit brush flaring to provide a very aggressive, controlled brushing action.



11141

Diameter	Wire Size	Trim* Length	Overall Length	Max. RPM	Standard Pack	Item Number	
						Steel	Stainless
1-1/8"	.014	3/8"	2-5/8"	18,000	10	11140	
	.020					11141	

* Trim length from bands

P **CRIMPED WIRE END BRUSHES** feature a solid end construction and very flexible brushing action ideal for more demanding light-duty cleaning applications in corners and hard-to-reach areas.



Diameter	Wire Size	Trim Length	Overall Length	Max. RPM	Standard Pack	Item Number	
						Steel	Stainless
3/8"	.0118	7/8"	2-1/2"	20,000	10	10188	—
1/2"	.006	7/8"	2-9/16"	25,000	10	10001 ▲ ■	10013 ■
	.0104					10002	10014
	.014					10003	10015
	.020					10004	10016
3/4"	.006	7/8"	2-9/16"	22,000	10	10005 ■	10017 ■
	.0104					10006	10018
	.014					10007	10019
	.020					10008 ■	10020
1"	.006	1"	2-3/16"	22,000	10	10009 ▲ ■	10021 ■
	.0104					10010 ■	10022 ■
	.014	1-1/8"	2-15/16"	10011 ▲	10023		
	.020			10012 ■	10024		

■ Packaged product available. See pages 136-139 for details. ▲ Available in non-sparking brass wire, see page 92-93 for details.

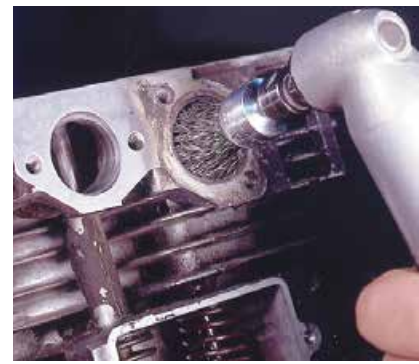

Cleaning the exhaust port of a gasoline engine.



10002

P **CRIMPED WIRE END BRUSHES - Coated Cup** - Feature a solid end construction and very flexible brushing action ideal for more demanding light-duty cleaning applications in corners and hard-to-reach areas. The plastic sleeve covering the cup protects the work surface from being scratched or marked.



Diameter	Wire Size	Trim Length	Overall Length	Max. RPM	Standard Pack	Item Number	
						Steel	Stainless
1/2"	.006	7/8"	2-9/16"	25,000	10	11000	11010
	.0104					11001	11011
3/4"	.006	7/8"	2-9/16"	22,000	10	11003	11013
	.0104					11004	11014
1"	.006	7/8"	2-3/4"	22,000	10	11006	11016
	.0104					1" 11007	11017



11013

P **CRIMPED WIRE END BRUSHES - Nickel-plated Cup** - Feature a solid end construction and very flexible brushing action ideal for more demanding light-duty cleaning applications in corners and hard-to-reach areas. **The nickel-plated cup is compliant with DOD MIL STD 2041D(SH).**



Diameter	Wire Size	Trim Length	Overall Length	Max. RPM	Standard Pack	Item Number	
						Steel	Stainless
1/2"	.006	7/8"	2-9/16"	25,000	10	10370 ●	10371 ●
	.0104					10372 ●	10373 ●
	.014					10374 ●	10375 ●
	.020					10376 ●	10377 ●
3/4"	.006	7/8"	2-9/16"	22,000	10	10374 ●	10375 ●
	.0104					10376 ●	10377 ●
	.014					10378	10379
	.020					10380 ●	10381
1"	.006	1"	2-7/8"	22,000	10	10378	10379
	.0104					10380 ●	10381
	.014	1-1/8"	2-15/16"	10379	10380 ●		
	.020			10381	10382		

● Non-stock product, contact Customer Service for lead times



10374

V **WOLVERINE® CRIMPED WIRE END BRUSHES** feature similar solid end construction and flexible brushing action, but they have been engineered to provide cost-effective use for less demanding applications.



Diameter	Wire Size	Trim Length	Overall Length	Max. RPM	Standard Pack	Item Number	
						Steel	Stainless
1/2"	.0104	7/8"	2-9/16"	25,000	10	36282	—
3/4"	.006	7/8"	2-9/16"	22,000	10	—	36283
	.0104					36247	—
	.014					36246	—
1"	.006	7/8"	2-3/4"	22,000	10	36284	36285
	.0104					36249	—
	.014					36248	—



36247

COATED ABRASIVES

NON-WOVEN ABRASIVES

POWER BRUSHES

NYLON BRUSHES

PACKAGED ITEMS

MAINTENANCE



11112

P **CRIMPED WIRE END BRUSHES - Banded** - Feature bands around the fill to reduce the exposed trim length and limit brush flaring at operating speed to provide an aggressive, controlled brushing action.



Diameter	Wire Size	Trim Length*	Overall Length	Max. RPM	Standard Pack	Item Number	
						Steel	Stainless
1/2"	.006	9/16"	2-9/16"	20,000	10	11100	11110
	.0104					11101	-
3/4"	.006	7/16"	2-11/16"	20,000	10	11102	11112
	.0104	3/8"				11103	11113
1"	.006	3/8"	2-5/8"	13,000	10	-	11114
	.0104					11105	11115

* Trim length from bands



10310

P ***CONTROLLED FLARE END BRUSHES** feature uniquely trimmed crimped wire fill for more effective brushing action and greatly enhanced durability when cleaning corners and fillet welds.



Diameter	Wire Size	Trim Length	Overall Length	Max. RPM	Standard Pack	Item Number	
						Steel	Stainless
1/2"	.0104	7/8"	2-9/16"	25,000	10	10301	10313
	.014					10302	10314
	.020					10303	10315
3/4"	.0104	7/8"	2-9/16"	22,000	10	10305	10317
	.014					10306	-
	.020					10307	10319
1"	.0104	1"	2-7/8"	22,000	10	10309	10321
	.014					10310	10322
1"	.020	1-1/8"	2-15/16"	22,000	10	10311	10323

* Patent #8,186,000 B2

The unique trim of a controlled flare end brush is designed specifically to address hard-to-reach areas, reducing filament fatigue and breakage typically associated with a standard end brush when cleaning corners and fillet welds.



Standard Crimped Wire End Brush



Controlled Flare End Brush



10059

P **CRIMPED WIRE PILOT BONDING BRUSHES - Banded - Solid end.** Originally designed to clean around rivet holes in aluminum aircraft panels but may be used in other similar applications.



Diameter	Wire Size	Trim Length	Overall Length	Pilot Diameter	Max. RPM	Standard Pack	Item Number	
							Steel	Stainless
1/2"	.005	3/8"	2-1/4"	3/32"	20,000	10	10056*	
				1/8"			10057*	
				5/32"			10058*	
				3/16"			10059*	

* Globally sourced product



35350

P **POLYFLEX® ENCAPSULATED CRIMPED WIRE END BRUSHES**
Burgundy Elastomer* - Feature fill material that has been encapsulated in an elastomer that gradually wears away to keep only the wire tips exposed; ideal for applications such as spot facing that may require maximum aggression and no flaring.

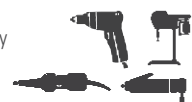

Diameter	Wire Size	Trim Length	Overall Length	Max. RPM	Standard Pack	Item Number	
						Steel	Stainless
Burgundy Elastomer* - Standard							
1/2"	.0104	7/8"	2-9/16"	18,000	10	35340	35500
3/4"	.0104	7/8"	2-9/16"	16,000	10	35345	35505 •
1"	.0104	7/8"	2-3/4"	14,000	10	35350	-
Orange Elastomer* - Heavy-Duty							
1/2"	.0104	7/8"	2-9/16"	18,000	10	35535	-
3/4"	.0104	7/8"	2-9/16"	16,000	10	35540	-
1"	.0104	7/8"	2-3/4"	14,000	10	35545	-

* See Elastomer Color Code Chart on page 51 for more information.

• Non-stock product, contact Customer Service for lead times

P **CIRCULAR FLARED END BRUSHES** feature crimped wire fill that has been “pre-flared” to match the working angle of the brush at operating speed; suited for addressing broad and slightly contoured surfaces.

Diameter	Wire Size	Max. RPM	Standard Pack	Item Number	
				Steel	Stainless
1"	.006	25,000	1	10033	10042
	.008			10034	10043
	.020			10099	—
1-1/4"	.006	20,000	1	10076	—
	.008			10035	—
	.020			—	—
1-1/2"	.006	20,000	1	10044	10045
	.008			10037	10046
	.020			10038	10047
2"	.014	25,000	2	11142	—
2-3/4"	.008	16,000	2	10039	10048
	.020			10040	—
	.014			—	—
3"	.006	16,000	2	10150	10151
	.008			10041 ■	10050
	.014			10134	—
	.020			10073	10074
4"	.008	15,000	1	—	96705

■ Packaged product available. See pages 136-139 for details.



P **POLYFLEX® ENCAPSULATED CIRCULAR FLARED END BRUSHES**

Black Elastomer* - Crimped wire fill that has been encapsulated in a heavy-duty elastomer that gradually wears away to keep only the wire tips exposed. Their saucer-shape, narrow face, and aggressive brushing action make them suitable for addressing edges, corners, and confined areas.

O.D. Diameter	Wire Size	Cup Size	Overall Length	Max. RPM	Standard Pack	Item Number	
						Steel	Stainless
1-3/4"	.006	3/4"	2"	25,000	2	35222	—
	.0104					35223	35226
	.020					35224	—
2"	.0104	3/4"	1-1/8"	20,000	2	35233	—
	.020					35234	—
	—					—	—

* See Elastomer Color Code Chart on page 51 for more information.



P **PENCIL END BRUSHES** contain straight wire fill material retained in a small diameter steel tube. They provide a light-duty brushing action suitable for very small recessed areas.

Tube Diameter	Wire Size	Trim Length	Overall Length	Max. RPM	Standard Pack	Item Number	
						Steel	Stainless
1/4"	.0104	3/4"	3-3/4"	8,000	10	99825	99823



When brushing a recessed area or the inside diameter of a tube, use an End Brush in the following manner: Insert the brush, start the brush rotating. Turn off the power before removing the brush. This will prevent the brush from flaring out and enable it to fit into the recessed area again.



1. Insert Brush 2. Apply Power 3. Shut-Off Power 4. Remove Brush



MOUNT END BRUSHES SAFELY

When mounting end brushes, the amount of overhang from the tool should be minimized by clamping on as much of the straight portion of the stem as possible. However, the collet or chuck should NOT clamp on the radius at the base of the stem to insure a secure hold before use. See photo above for the correct brush orientation.

BORE-RX™ CROSSHOLE DEBURRING BRUSHES



Deburring intersecting oil passages in an engine block.

**MADE IN
USA**

Designed for automated use in CNC machining centers and dedicated equipment. They are densely filled for high aggression and long tool life and feature a 3/8" diameter steel stem with a flat for use in a collet or end-mill holder.

Bore-Rx brushes are ideal tools for removing burrs from internal edges. Since they can eliminate manual deburring operations, these internal brushing tools help to improve part-to-part consistency and reduce direct labor costs. Bore-Rx brushes are available in sizes ranging from 3/4" to 4" in diameter, and they are designed to be interpolated within bore sizes that are larger than the brush diameter.

Operating Parameters For Wire Bore-Rx Brushes

Brush Diameter	Recommended RPM	Recommended Feed Rate
5/8" - 7/8"	8,000	20"/min
1" - 1-1/2"	8,000	20"/min
2" - 2-1/2"	6,000	20"/min
3" - 4"	3,000	20"/min

Tool Paths for Crosshole Deburring

An effective tool path for most crosshole deburring jobs is circular interpolation using the following guidelines to determine diameter of interpolation. The interpolation should be performed at a depth where the center of the brush face is at the center of the intersecting hole.

$$\text{Diameter of Interpolation} = \text{Hole Diameter} - \text{Brush Diameter}$$



17205



BORE-RX™ BRUSHING TOOLS - Crimped wire fill - Feature dense wire fill for aggressive deburring action on ductile metals and other hard-to-deburr materials.

Diameter	Wire Size	Face Width	Overall Length	Max. RPM	Standard Pack	Item Number
						Steel*
3/4"	.005	3/8"	4-3/8"	8,000	1	17202
		3/4"	4-3/4"			17203
7/8"	.006	3/4"	4-3/4"	8,000	1	17205
1"	.006	3/4"	5"	8,000	1	17207 •
1-1/4"	.006	3/4"	4-3/4"	8,000	1	17209 •
1-1/2"	.006	1"	5"	8,000	1	17211 •
2"	.006	1"	4-1/4"	6,000	1	17214 •
2-1/2"	.008	1"	4-3/4"	6,000	1	17216 •
3"	.008	1"	5-1/4"	6,000	1	17218 •
4"	.0118	1"	6-1/4"	6,000	1	17219

* Stainless Steel fill is available by special order.

• Non-stock product, contact Customer Service for lead times



17218

Note: All Bore-Rx brush stems have a 2" long flat for use in end mill holders. Alternatively, they can be mounted in 3/8" collets. Bore-Rx extension holder is available. Contact Application Engineering at 888-299-APPS (2777).

CUSTOMIZABLE CROSSHOLE DEBURRING SOLUTIONS

Replacement Bore-Rx Brush Heads and Reusable Bore-Rx Arbors

In high production applications, reusable arbors reduce manufacturing costs by allowing the use of inexpensive brush head replacements. Brush heads are made-to-order in diameters ranging from 3/4" to 1-1/2" with face widths of 1/4" to 1". They are available on 3/16" and 1/4" pins. The pin diameter is based on the application and determines brush density. Contact Application Engineering at 888-299-APPS (2777) for more information.



Replacement Head



Reusable Extension 03991 •



Reusable Arbor 03993 •

POWER AND HAND TUBE BRUSHES

Weiler offers a comprehensive line of power and hand tube brushes for internal cleaning and deburring applications in tubing, pipe, drilled-and-tapped holes, and machined bores and passages. Due to their twisted-in-wire construction, the use of power tube brushes is limited to low-speed power tools such as drills and drill presses and to CNC and manual machine tools in which the RPM can be precisely programmed or set. In addition, they should not be used in reverse rotation to prevent unraveling of the stem wire. Available in a wide variety of brush configurations and fill materials, Weiler can supply a tube brush for any application. If you do not see what you need in this catalog, see the Special Tube Brush Design Specification Sheet on page 85, or call our toll-free Application Engineering Hotline at 888-299-APPS (2777) for assistance.

APPLICATIONS

- Deburring and cleaning drilled-and-tapped holes and other internal threads
- Cleaning and finishing the ID of tubing and pipe
- Crosshole deburring
- Removing burrs and chips from internal keyways, slots, and grooves
- Removing paint, coatings, and build-up other foreign material from the surfaces of bores and passages

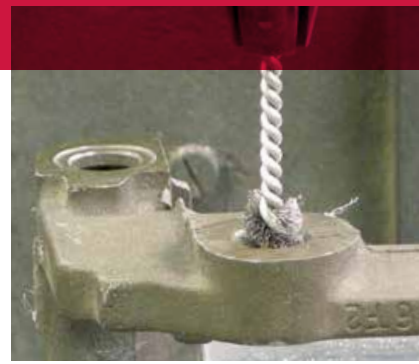

Removing zinc coating from holes in a brake bracket.

MADE IN USA

POWER AND HAND TUBE BRUSH SELECTION TIPS

- A flat burr style tube brush is most effectively used with a holder on blind, threaded holes.
- A round tube brush is most effectively used fully chucked on smooth or threaded blind holes.
- A single stem, single spiral tube brush is most effectively used for manual or hand cleaning applications.
- A double stem, double spiral tube brush is most effectively used with power tools for heavy-duty cleaning and deburring.
- A polyflex encapsulated double stem, double spiral tube brush is most effectively used on power tools for very aggressive cleaning and deburring applications.



P **DOUBLE STEM, DOUBLE SPIRAL** feature four stem wires and a double spiral of straight wire fill material to provide aggressive cleaning and deburring action.



Diameter	Wire Size	Brush Part	Stem Diameter	Overall Length	Max. RPM	Standard Pack	Item Number	
							Steel	Stainless
3/8"	.003	1-1/2"	1/8"	4"	2,000	10	21342	—
	.006	2-1/8"		6"			21232	—
1/2"	.004	2"	5/32"	5"	2,000	10	21106	21116
	.006						21107 ▲ ■	21117
	.0104						21252	—
5/8"	.005	2"	7/32"	5"	2,000	10	21108 ■	21118
	.008						21109 ▲	21119
	.0104						21184	—
3/4"	.006	2-1/2"	1/4"	5-1/2"	2,000	10	21110 ▲ ■	21120
	.008						21247	—
	.0104						21111	21121
7/8"	.006	2-1/2"	1/4"	5-1/2"	2,000	10	21112	21122
	.0104						21113	21123
1"	.006	2-1/2"	1/4"	5-1/2"	2,000	10	21114 ▲ ■	21124
	.0104						21115	21125
1-1/4"	.006	2-1/2"	1/4"	5-1/2"	2,000	10	21164	21245
	.0104						21167 ★	21236
1-1/2"	.014	2-1/2"	1/4"	5-1/2"	2,000	10	—	21413

■ Packaged product available. See pages 136-139 for details. ★ 5" Overall length

▲ Available in non-sparking brass wire, see page 92-93 for details.



COATED ABRASIVES

NON-WOVEN ABRASIVES

POWER BRUSHES

NYLON BRUSHES

PACKAGED ITEMS

MAINTENANCE

P POLYFLEX™ ENCAPSULATED DOUBLE STEM, DOUBLE SPIRAL

Burgundy Elastomer* - Encapsulated with an elastomer that leaves only the sharp wire tips exposed for maximum aggression and a very rigid brushing action.



Diameter	Wire Size	Brush Part	Stem Diameter	Overall Length	Max. RPM	Standard Pack	Item Number	
							Steel	
1/2"	.006	2"	5/32"	5"	2,000	10	35821	
5/8"	.0104	2"	7/32"	5"	2,000	10	35822	
3/4"	.0104	2-1/2"	1/4"	5-1/2"	2,000	10	35823	
1"	.0104	2-1/2"	1/4"	5-1/2"	2,000	10	35825	•

* See Elastomer Color Code Chart on page 51 for more information.

• Non-stock product, contact Customer Service for lead times

P ROUND - Feature a single continuous length of stainless steel stem wire and a single spiral of crimped wire fill for a more flexible brushing action; for use on smooth or threaded blind holes.



Diameter	Wire Size	Brush Part	Stem Diameter	Overall Length	Max. RPM	Standard Pack	Item Number	
							Steel	Stainless
1/4"	.004	1"	1/8"	3-1/2"	2,000	10	21072 ▲	21081 ■
5/16"	.005	1"	1/8"	3-1/2"	2,000	10	21175	–
3/8"	.004	1"	1/8"	3-1/2"	2,000	10	21073 ■	21082
	.006						–	
	.008						21264	21240
7/16"	.005	1"	1/8"	3-1/2"	2,000	10	21142	21181
1/2"	.005	1"	3/16"	3-1/2"	2,000	10	21074 ▲ ■	21083
							–	–
9/16"	.005	1"	3/16"	3-1/2"	2,000	10	21143	–
							–	21404
5/8"	.005	1"	3/16"	3-1/2"	2,000	10	21075 ■	21084
							21265	–
11/16"	.005	1"	3/16"	3-1/2"	2,000	10	21144	–
3/4"	.006	1"	7/32"	3-1/2"	2,000	10	21076	21085
							21266	–
13/16"	.005	1"	7/32"	3-1/2"	2,000	10	21146	–
7/8"	.006	1"	7/32"	3-1/2"	2,000	10	21077 ■	21086
							21267	–
15/16"	.005	1"	7/32"	3-1/2"	2,000	10	21148 •	–
1"	.005	1"	1/4"	3-1/2"	2,000	10	21149	21340
							21078 ■	21087
1-1/8"	.005	1"	1/4"	3-1/2"	2,000	10	21150	–
							21079	21088
1-1/4"	.008	1"	1/4"	3-1/2"	2,000	10	21080	21089
							–	–
1-1/2"	.008	1"	1/4"	3-1/2"	2,000	10	21203 ▲	–
							21269	–
2-1/4"	.008	1"	1/4"	3-1/2"	2,000	10	21322	–

■ Packaged product available. See pages 136-139 for details. ▲ Available in non-sparking brass wire, see page 92-93 for details.

• Non-stock product, contact Customer Service for lead times

Correct Mounting in Chuck



Incorrect Mounting in Chuck



TUBE BRUSH OPERATING RECOMMENDATIONS

The stems in power tube brushes are not as strong as the stems in most other brushes. Therefore, it is very important to avoid any load conditions and brush speeds that can cause excessive stem deflections and destructive bending.

A suggested guideline to avoid this unsafe condition is minimizing the overhang of the stem to under an inch, and running the brush at speeds below 2,000 RPM.

Increasing overhang could decrease the safe speed at which the brush can operate. To reach into deeper holes, use drill extension rods instead of increasing stem overhang.

BEFORE STARTING THE BRUSH:

- Secure brush in chuck.
- Ensure clockwise brush rotation (running the brush counter-clockwise could cause the brush to fall apart.)
- Clamp work securely.
- Position all guards in place.
- Align brush with the work so the brush rotates on its true centerline to prevent any stem deflections.
- Guide the brush into the hole before starting the brush rotation.
- Always wear eye protection.

P

BURRITE - Feature a single continuous length of stainless steel stem wire and filled with a tuft of crimped wire to provide an aggressive flat side action; ideal for cleaning and deburring internal threads.

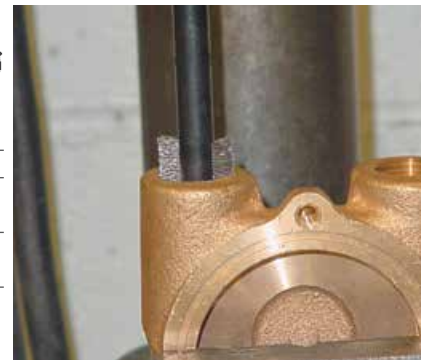

Deburring the threads of a tapped hole using a burrite brush in a holder.

Diameter	Wire Size	Brush Part	Stem Diameter	Overall Length	Max. RPM	Standard Pack	Item Number	
							Steel	Stainless
1/4"	.003	9/16"	3/32"	2-1/8"	2,000	10	21000	-
	.005						21001	21050
5/16"	.003	9/16"	3/32"	2-1/8"	2,000	10	21004	-
	.005						21005	-
3/8"	.003	9/16"	3/32"	2-1/8"	2,000	10	21008	-
	.005		1/8"				21009	21051
	.005		1/8"				21023	-
7/16"	.003	9/16"	3/32"	2-1/8"	2,000	10	21014	-
	.005						21015	-
1/2"	.003	9/16"	3/32"	2-1/8"	2,000	10	21020	-
	.005		1/8"				21021	21053
	.005		1/8"				21025	-
9/16"	.003	5/8"	1/8"	2-1/4"	2,000	10	21027	-
	.005						21028	-
5/8"	.003	5/8"	1/8"	2-1/4"	2,000	10	21030	-
	.005						21031	21055
3/4"	.005	5/8"	1/8"	2-1/4"	2,000	10	21034	21056
	.008						21035	-
7/8"	.005	5/8"	1/8"	2-1/4"	2,000	10	21036	21057
1"	.005	5/8"	1/8"	2-1/4"	2,000	10	21040	21058
	.008						21041	-
1-1/8"	.005	5/8"	1/8"	2-1/4"	2,000	10	21044	-

• Non-stock product, contact Customer Service for lead times



21014

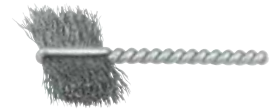

21040

P

BURRITE HOLDERS - Feature a 1/4" stem for convenient mounting into the chuck of a drill or the collet of a machine tool and allow the brush to be used in either direction of rotation. They allow the brush to be used in a standard tapping cycle for deburring threaded holes in CNC machining centers.



For Brush Stem Dia.	Holder Diameter	Overall Length	Standard Pack	Item Number
3/32"	1/4"	3-1/8"	5	95202
1/8"	3/8"	3-3/8"	5	95203



95203

P

SINGLE STEM, SINGLE SPIRAL - Feature a single continuous length of galvanized steel stem wire with a formed eye loop for convenient hand use. The single spiral of straight wire fill allows for easy manual insertion into the ID.

Diameter	Wire Size	Brush Part	Stem Diameter	Overall Length	Standard Pack	Item Number	
						Steel	Stainless
1/8"	.003	1"	3/32"	6"	10	21246	21249
3/16"	.003	1-1/2"	3/32"	7"	10	21090 ▲	21098
	.005					21091	21099
1/4"	.003	1-1/2"	3/32"	7"	10	21092 ▲	21100
	.005					21093 ▲	21101
	.006					21161	-
3/8"	.004	2"	1/8"	8"	10	21094 ▲	21414
	.006					21095	21103
1/2"	.004	2"	1/8"	8"	10	21096 ▲	21104
	.006					21097	21105
	.008					21162	-
9/16"	.005	2-1/2"	5/32"	9"	10	21233	-

▲ Available in non-sparking brass wire, see page 92-93 for details.



21096

COATED ABRASIVES

NON-WOVEN ABRASIVES

POWER BRUSHES

NYLON BRUSHES

PACKAGED ITEMS

MAINTENANCE

P NYLON HAND TUBE BRUSHES feature a single continuous length of galvanized steel stem wire with a formed eye loop for convenient hand use. The single spiral of straight nylon fill allows for easy manual insertion and scratch-free cleaning of the ID.



Diameter	Fill Diameter	Brush Part	Stem Diameter	Overall Length	Standard Pack	Item Number
						Nylon
1/4"	.005	2"	3/32"	6-1/4"	36	44110*
3/8"	.005	2"	3/32"	6-1/4"	36	44213*
1/2"	.010	3"	1/8"	8-1/2"	36	44111*
3/4"	.012	3"	1/8"	8-1/2"	36	44112*
1"	.014	4"	5/32"	12-1/4"	36	44113*
1-1/4"	.014	4"	5/32"	13"	36	44114*
2"	.014	5"	3/16"	16-3/4"	36	44115*

* Globally sourced product

P PERCOLATOR BRUSH features single stem, single spiral construction with an eye loop and straight white nylon fill. Intended for cleaning the internal passages in coffee percolators, this brush can be also be used in other similar manual cleaning applications.



Diameter	Fill Diameter	Brush Part	Stem Diameter	Overall Length	Standard Pack	Item Number
						Nylon
7/16"	.010	3-1/2"	5/32"	11-1/2"	10	44316

P VALVE GUIDE BRUSHES are made with single stem, single spiral construction and have a permanently-attached 1/4" diameter long steel handle for convenient hand use or for mounting into a chuck. Intended for removing heavy deposits from valve guides in gas and diesel engines, these brushes can also be used in a range of other similar applications.



Diameter	Fill Diameter / Material	Brush Part	Overall Length	Max. RPM	Standard Pack	Item Number
1/4"	.0104 Steel	2"	10"	2,000	10	95563 •
5/16"						95027
11/32"						95566 •
3/8"						95028
7/16"						95665 •
1/2"	95029					
11/32"	.008 Nylon	2-1/2"	10"	2,000	10	95660 •
3/8"	.012 Nylon					95567 •

• Non-stock product, contact Customer Service for lead times

P GUN CLEANING BRUSHES - Rifle Brushes - Constructed using a continuous piece of stem wire and fine bronze wire fill for a scratch-free cleaning action in gun barrels, these flexible tube brushes are designed to be attached to extension rods using the 8-32 male coupling.



Caliber	Brush Part	Overall Length	Coupling Size	Standard Pack	Item Number
					Bronze
22	2-1/4"	3-1/4"	8-32	10	95301
30	2-1/4"	3-1/4"	8-32	10	99786 •
35	2-1/4"	3-1/4"	8-32	10	99788 •
45	2-1/4"	3-1/4"	8-32	10	99791 •

• Non-stock product, contact Customer Service for lead times

P GUN CLEANING BRUSHES - Shotgun Brushes - Constructed using a continuous piece of stem wire and fine bronze wire fill for a scratch-free cleaning action in gun barrels, these flexible tube brushes are designed to be attached to extension rods using the 5/16"-27 male coupling.



Gauge	Brush Part	Overall Length	Coupling Size	Standard Pack	Item Number
					Bronze
12	1-5/8"	2-7/8"	5/16-27	10	99714 •
16	1-5/8"	2-7/8"	5/16-27	10	99694 •
20	1-5/8"	2-7/8"	5/16-27	10	95084
410	1-5/8"	2-7/8"	5/16-27	10	95129 •

• Non-stock product, contact Customer Service for lead times

SPECIAL TUBE BRUSH SPECIFICATION SHEET:

(Use the illustration on this page as a guide)

1. Brush diameter _____
2. Length of brush part _____
3. Overall brush length _____
4. Special stem diameter (if required) _____
5. Stem material:
 - Galvanized Steel Stainless Other
6. Application _____
7. Brush fill material:
 - Steel wire Stainless wire
 - Nylon Abrasive Filament (Nylox®)
 - Brass wire Other _____
8. Fill material diameter _____
9. Special tip style (if required) _____
10. Single stem Double stem
11. Order Quantity _____

* Special tube brushes are not returnable, as they are manufactured to order.

Name: _____
 Company Name: _____
 Address: _____
 Phone: (____) _____
 Fax: (____) _____
 E-mail: _____

End-User Name: _____
 City: _____
 State: _____ Zip: _____

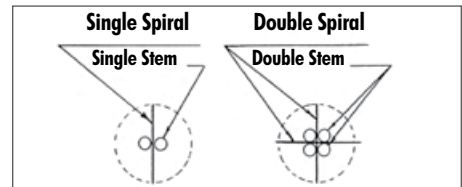
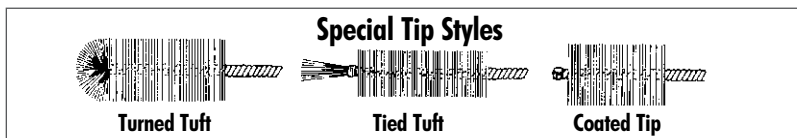
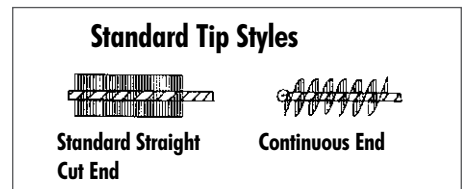
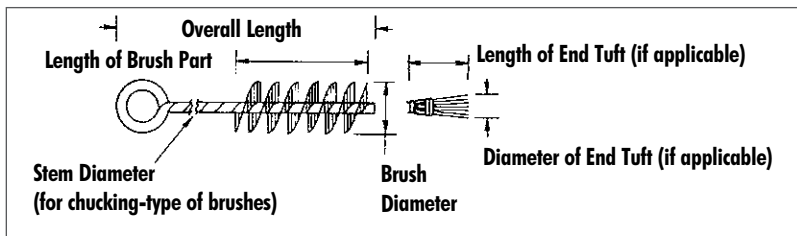

FOR ADDITIONAL INFORMATION CALL:

Weiler's Application Engineering
 Hotline toll free at:
 888-299-APPS (2777)

FAX SPECIFICATION SHEET TO:

Application Engineering
 Fax: 800-635-3615



NEW!

CROSSFLEX™

Cross hole deburring and honing solutions for off-hand and automated applications.

See pages 86-89

WHY WEILER BONDED ABRASIVES COATED ABRASIVES NON-WOVEN ABRASIVES POWER BRUSHES NYLOX BRUSHES PACKAGED ITEMS MAINTENANCE

CROSSFLEX™ HONING BRUSHES

CrossFlex offers machinists the right combination of performance and value for professional honing applications. Flexible filaments provide the correct pressure to create an ideal hone; one bore after another. It's the ideal tool to create cross-hatch patterns for improved oil retention and increased part efficiency. The strong self-centering system leaves a smooth, even surface finish free of metal burrs whether used in a manual or automated application.



Deburring cross holes in a firearms component.

No matter what type or size cylinder, Weiler's CrossFlex brushes deliver the options you need to solve your toughest deburring and honing challenges.

FEATURES & BENEFITS:

- **Desired Finish**
CrossFlex offers a wide range of grits and sizes allowing machinists to achieve the desired finish.
- **Heavy Burr Removal**
Increased brush to part contact ensures that the heaviest burrs will be removed, outperforming standard nylon tube brushes.
- **Long Life**
CrossFlex brushes have a long operational life, lowering total cost of use compared to other brush options.
- **Flexible Nylon Stems**
Distribute pressure evenly and self centers within the part to create an ideal hone.
- **Consistent Cross Hatch Pattern**
Helps to seat piston rings and retains oil for lubrication in a combustion cylinder.
- **Collet Ready Brushes**
Deliver a true center rotation and exceptional brush balance for automated applications or hand held use.



Deburring mounting holes on a machined component.

CROSSFLEX ABRASIVE GRITS: Every individual brush end tip is colored to indicate the grit of that brush.



COLLET READY BENEFITS FOR SMALL DIAMETER BRUSHES:

- Reduces brush run-out
- Strengthens and sturdies brush shaft for better stability and overall reach
- Strong positive engagement with tool holder



Collet ready CrossFlex brush in a CNC machine.

NEW!

SMALL DIAMETER CROSSFLEX HONING BRUSHES

Silicon carbide cross-honing brushes for standard use. Ideal for deburring small diameter cross hole intersections.



For Hole Sizes in Inches	For Hole Sizes in mm	Length of Brush Part	Overall Length	Shank Diameter	Max RPM	120 Grit Item No.	180 Grit Item No.	240 Grit Item No.	320 Grit Item No.
0.177"	4.5 mm	0.787"	6"	0.083"	1,000	—	34105	34106	34107
0.1857"	4.7625 mm			—		34108	34109	34110	
0.197"	5 mm			34111		34112	34113	34114	
0.217"	5.5 mm			34115		34116	34117	34118	
0.236"	6 mm			34119		34120	34121	34122	
0.25"	6.35 mm			34123		34124	34125	34126	
0.276"	7 mm	1.969"	7.875"	0.13"	900	34127	34128	34129	34130
0.315"	8 mm			0.142"		34131	34133	34134	34135
0.354"	9 mm			34136		34137	34138	34139	
0.375"	9.5 mm			34141		34142	34143	34144	
0.394"	10 mm			34145		34146	34147	34148	
0.433"	11 mm			34149		34150	34151	34152	
0.472"	12 mm	2.48"	7.875"	0.157"	900	34153	34154	34155	34156
0.5"	12.7 mm			0.173"		34158	34159	34160	34161
0.552"	14 mm			0.197"		34162	34163	34164	34165
0.625"	16 mm			34166		34167	34168	34169	
0.709"	18 mm			34170		34171	34172	34173	
0.75"	19mm			34174		34175	34176	34177	
0.787"	20 mm	3"	7.875"	0.213"	900	34178	34179	34180	34181
0.875"	22 mm					34182	34183	34184	34185
0.9375"	23.8 mm					34186	34187	34188	34189



NEW!

COLLET READY – SMALL DIAMETER CROSSFLEX HONING BRUSHES

Silicon carbide cross-honing brushes for standard use within automated applications and to reduced brush run-out.



For Hole Sizes in Inches	For Hole Sizes in mm	Length of Brush Part	Overall Length	Shaft Diameter	Max RPM	120 Grit Item No.	180 Grit Item No.	240 Grit Item No.	320 Grit Item No.
0.177"	4.5 mm	0.75"	6"	5/32"	1,000	—	34298	34299	34359
0.188"	4.763 mm					—	34300	34301	34302
0.197"	5 mm					34303	34304	34305	34306
0.217"	5.5 mm	1.5"	7.875"	5/32"	1,000	34307	34308	34309	34310
0.236"	6 mm					34311	34312	34313	34314
0.25"	6.35 mm					34315	34316	34317	34318
0.276"	7 mm	2"	7.875"	1/4"	900	34319	34320	34321	34322
0.315"	8 mm					34323	34324	34325	34326
0.354"	9 mm					34327	34328	34329	34330
0.375"	9.5 mm					34331	34332	34333	34334
0.394"	10 mm					34335	34336	34337	34338
0.433"	11 mm					34339	34340	34341	34342
0.472"	12 mm	2.5"	7.875"	8 mm	900	34343	34344	34345	34346
0.5"	12.7 mm					34347	34348	34349	34350
0.552"	14 mm					34351	34352	34353	34354
0.625"	16 mm					34355	34356	34357	34358

COATED ABRASIVES
 NON-WOVEN ABRASIVES
 POWER BRUSHES
 NYLON BRUSHES
 PACKAGED ITEMS
 MAINTENANCE



Cleaning burrs out of an automotive head port.



NEW!

MEDIUM DIAMETER CROSSFLEX HONING BRUSHES

Silicon carbide cross-honing brushes for standard use. Ideal for changing the surface finish in machined bores and deburring the ID of castings.



For Hole Sizes in Inches	For Hole Sizes in mm	Length of Brush Part	Overall Length	Shank Diameter	Max RPM	120 Grit Item No.	180 Grit Item No.	240 Grit Item No.	320 Grit Item No.
1"	25.4 mm	3"	7.875"	0.213"	900	34190	34191	34192	34193
1.125"	29 mm			0.224"	800	34194	34195	34196	34197
1.25"	31.8 mm			0.252"	34198	34199	34200	34201	
1.375"	35 mm			34202	34203	34204	34205		
1.5"	38 mm			34206	34207	34208	34209		
1.625"	41 mm			34210	34211	34212	34213		
1.75"	45 mm			34214	34215	34216	34217		
1.875"	47.6 mm			34218	34219	34220	34221		
2"	51 mm			34222	34223	34224	34225		
2.125"	54 mm			0.283"	700	34226	34227	34228	34229
2.25"	57 mm					34230	34231	34232	34233
2.375"	60 mm					34234	34235	34236	34237
2.5"	64 mm					34238	34239	34240	34241
2.625"	67 mm					34242	34243	34244	34245
2.75"	70 mm					34246	34247	34248	34249
2.875"	73 mm					34250	34251	34252	34253
3"	76 mm	34254	34255			34256	34257		



34257

NEW!

HEAVY-DUTY MEDIUM DIAMETER CROSSFLEX HONING BRUSHES

Silicon carbide cross-honing brushes for heavy-duty use. Ideal for changing the surface finish in machined bores and deburring the ID of castings.

For Hole Sizes in Inches	For Hole Sizes in mm	Length of Brush Part	Overall Length	Shank Diameter	Max RPM	120 Grit Item No.	180 Grit Item No.	240 Grit Item No.	320 Grit Item No.
3"	76 mm	5.5"	13.5"	0.311"	700	34258	34259	34260	34261
3.25"	83 mm					34262	34263	34264	34265
3.5"	89 mm					34266	34267	34268	34269



34274



34294



Engine cylinder head honing.

NEW!

HEAVY-DUTY LARGE DIAMETER CROSSFLEX HONING BRUSHES

Silicon carbide cross-honing brushes for heavy-duty use. Ideal for cross hatching in combustion cylinders.



For Hole Sizes in Inches	For Hole Sizes in mm	Length of Brush Part	Overall Length	Shank Diameter	Max RPM	120 Grit Item No.	180 Grit Item No.	240 Grit Item No.	320 Grit Item No.
3.75"	95 mm	5.5"	13.5"	0.311"	700	34270	34271	34272	34273
4"	101 mm	6.5"		0.346	600	34274	34275	34276	34277
4.25"	108 mm					34278	34279	34280	34281
4.5"	114 mm					34282	34283	34284	34285
5"	127 mm	18"	0.402"	34286	34287	34288	34289		
5.5"	140 mm			34290	34291	34292	34293		
6"	152 mm			34294	34295	34296	34297		

SPECIALTY BRUSHES

Weiler understands that not all your finishing or deburring applications have a standard solution. For instances where applications require unique sizes, lengths or abrasives; Weiler Process Solutions (WPS) specialists work with you to provide custom CrossFlex brushes for your specific application.

- Custom sized for your specific bore diameters
- Brushes with shorter or longer stems for your particular application
- Collet ready or other connection methods
- Options in a variety of abrasives including **silicon carbide, aluminum oxide, zirconia alumina** and **ceramic** grains



Custom large diameter ceramic CrossFlex brush.



An application engineering program designed to provide Weiler customers with engineering support to identify value added opportunities in their processes.

To learn more about Weiler's specialty solutions go to: weilerabrasives.com/wps

COATED ABRASIVES

NON-WOVEN ABRASIVES

POWER BRUSHES

NYLON BRUSHES

PACKAGED ITEMS

MAINTENANCE

MINIATURE BRUSHES



Removing galled spots from a metal forming die.

THE WEILER FAMILY began producing miniature brushes for the jewelry industry in 1898, and their tradition of providing the highest quality, most cost-effective products continues to this day.

Weiler's line of miniature brushes are designed for precision cleaning, light deburring, and finishing applications in a variety of crafts, trades, and industries. In addition to use in jewelry production and in dental and optical labs, miniature brushes have many applications in modern industries such as electronics and instrumentation production, aerospace and aircraft manufacture, and precision tool and die shops. They are permanently mounted on 1/8" or 3/32" stems for quick mounting and efficient use on high-speed electric rotary tools and air-powered pencil die grinders.

APPLICATIONS

- Decorative finishing
- Light deburring and edge blending
- Buffing and polishing of small parts
- Light-duty cleaning



P WIRE WHEEL BRUSHES - Fine crimped wire fill for light-duty cleaning and deburring.



Diameter	Wire Size	Trim Length	Stem Size	Stem Length	Max. RPM	Standard Pack	Item Number		
							Steel	Stainless	Brass
5/8"	.005	1/8"	1/8"	1-1/2"	37,000	144	—	99554	—
3/4"	.003	3/16"	1/8"	1-1/2"	37,000	144	26000	—	26001 •
	.005						26003	26005	26004 •
3/4"	.003	3/16"	3/32"	1-1/2"	37,000	144	26140 •	—	26141 •
	.005						26143	—	26144
1"	.003	5/16"	1/8"	1-1/2"	37,000	144	26012	26014	—
	.005						26015	26017	26016
	.005	5/16"	3/32"				26155 •	—	—
1-1/4"	.005	3/8"	1/8"	1-1/2"	37,000	144	26021	—	—
1-1/2"	.005	1/2"	1/8"	1-1/2"	25,000	144	26296	26294	—

• Non-stock product, contact Customer Service for lead times

P BRISTLE WHEEL BRUSHES - Natural hair fill for scratch-free cleaning of small parts or for buffing and polishing of features such as slots and grooves using abrasive compounds.



Diameter	Fill Type	Trim Length	Stem Size	Stem Length	Max. RPM	Standard Pack	Item Number
3/4"	Stiff Hair	3/16"	3/32"	1-1/2"	37,000	144	26041
	Soft Hair						26042
	Stiff Hair*						26043
	Stiff Hair		1/8"	26059			

* Double thick

P WIRE CUP BRUSHES - Fine crimped wire fill for light-duty cleaning or deburring in confined areas.



Dia.	Wire Size	Trim Length	Stem Size	Stem Length	Overall Length	Max. RPM	Standard Pack	Item Number		
								Steel	Stainless	Brass
5/8"	.003	1/4"	1/8"	1-1/2"	2"	37,000	144	26071	—	26072
	.005							26074	26076	26075

P BRISTLE CUP BRUSHES - Natural hair fill for scratch-free cleaning of confined areas or for buffing and polishing of small recessed surfaces using abrasive compounds.



Dia.	Fill Type	Trim Length	Stem Size	Stem Length	Overall Length	Max. RPM	Standard Pack	Item Number
1/2"	Stiff Hair	7/32"	3/32"	1-1/2"	2"	37,000	144	26091
9/16"	Stiff Hair	1/4"	1/8"	1-1/2"	2"	37,000	144	26093
	Soft Hair							26094 •
1"	Stiff Hair	7/16"	1/8"	1-1/2"	2-3/8"	25,000	144	26095
	Soft Hair							26096 •

• Non-stock product, contact Customer Service for lead times

P WIRE END BRUSHES - Fine crimped wire fill for light-duty cleaning or deburring in very small recessed areas or ID's.



Dia.	Wire Size	Trim Length	Stem Size	Stem Length	Overall Length	Max. RPM	Standard Pack	Item Number		
								Steel	Stainless	Brass
3/16"	.003	1/4"	1/8" 3/32"	1-1/4"	1-7/8"	37,000	144	26098 26101	26099 -	26097 -
1/4"	.005	7/16"	1/8"	1-1/4"	2-1/8"	37,000	144	26107	26108	26106
5/16"	.005	9/16"	1/8"	1-1/4"	2-3/8"	25,000	144	26113	26114	-

• Non-stock product, contact Customer Service for lead times



P BRISTLE END BRUSHES - Natural hair fill for scratch-free cleaning or for buffing and polishing of very small recesses using abrasive compounds.



Dia.	Fill Type	Trim Length	Stem Size	Stem Length	Overall Length	Max. RPM	Standard Pack	Item Number
3/16"	Stiff Hair Soft Hair Stiff Hair	1/4"	1/8" 3/32"	1-1/4"	1-7/8"	37,000	144	26115 26122 26116
1/4"	Stiff Hair	3/8"	1/8"	1-1/4"	2-1/8"	37,000	144	26119
5/16"	Stiff Hair	9/16"	1/8"	1-1/4"	2-3/8"	25,000	144	26121



P BRISTLE END BRUSHES - Plastic Ferrule

Feature a plastic ferrule or cup to protect internal surfaces during use.



Dia.	Fill Type	Trim Length	Stem Size	Stem Length	Overall Length	Max. RPM	Standard Pack	Item Number
3/16"	Stiff Hair	1/4"	1/8"	1-1/4"	1-7/8"	37,000	144	26128
1/4"	Stiff Hair	3/8"	1/8"	1-1/4"	2-1/8"	37,000	144	26131
5/16"	Stiff Hair	9/16"	1/8"	1-1/4"	2-3/8"	25,000	144	26133



P ABRASIVE NYLON END BRUSHES - Plastic Ferrule - Nylox® abrasive nylon fill for buffing and polishing without compounds. They can also be used in automated applications for precision deburring and finishing of small part features.



Dia.	Filament Dia./Grit	Trim Length	Stem Size	Stem Length	Overall Length	Max. RPM	Standard Pack	Item Number
3/16"	.018/500	1/4"	1/8"	1-1/4"	1-7/8"	37,000	144	26136
1/4"	.018/500	3/8"	1/8"	1-1/4"	2-1/8"	37,000	144	26138
5/16"	.018/500	9/16"	1/8"	1-1/4"	2-3/8"	25,000	144	26146



Deburring the I.D. of a small machined part with miniature wire end brush.



WHY WEILER
BONDED ABRASIVES
COATED ABRASIVES
NON-WOVEN ABRASIVES
POWER BRUSHES
NYLOX BRUSHES
PACKAGED ITEMS
MAINTENANCE

NON-SPARKING BRUSHES



Creating an antique finish on a brass plate.

Weiler offers an assortment of wire non-sparking brushes featuring high-quality bronze or brass wire that offer a very soft brushing action in comparison to steel and stainless steel and will not generate a spark when used on metal surfaces. These products are available in a variety of knot wire and crimped wire configurations for use in a broad range of surface cleaning applications, and they are manufactured with individual knot hole and solid ring construction for high performance and long life. Weiler's non-sparking power brushes are available with plain arbor holes, nuts, and permanently-attached stems for use on a variety of tools.

APPLICATIONS

- Light to medium duty cleaning of surfaces, recesses, and ID's
- Deburring component parts machined from soft, non-ferrous metals
- Cleaning molds and dies in the injection-molding and extrusion of plastics
- Maintenance activities in areas where flammable or potentially explosive materials are present, such as refineries and petrochemical plants.

**MADE IN
USA**



13121

P STANDARD TWIST WHEELS provide a heavy-duty brushing action with some flexibility; ideal for more demanding cleaning applications.



Dia.	Wire Size	Arbor Hole	No. of Knots	Face Width	Trim Length	Max. AH Avail.	Thickness at Face Plates	Max. RPM	Std. Pack	Item Number
										Bronze
3"	.020	1/2" - 3/8"	20	3/8"	5/8"	1/2"	7/16"	25,000	10	08271
4"	.020	5/8" - 11	24	1/2"	7/8"	-	7/16"	20,000	5	13121

For threaded arbor hole adapters see page 61.



01475

P CRIMPED WIRE WHEELS provide a flexible brushing action and consistent performance for light-duty cleaning and deburring applications.



Diameter	Wire Size	Arbor Hole	Face Width	Trim Length	Max. AH Avail.	Thickness at Face Plates	Max. RPM	Standard Pack	Item Number
									Brass
6"	.005	5/8" - 1/2"	1/2"	1-7/16"	1-1/4"	7/16"	6,000	2	01415
	.0118								01475

For arbor hole adapters see page 72. For other available arbor holes, see Arbor Hole Variations Table on page 51.



29078

P SMALL DIAMETER CRIMPED WIRE WHEELS provide a flexible brushing action and consistent performance for light-duty cleaning and deburring applications requiring a small wheel.



Diameter	Wire Size	Arbor Hole	Face Width	Trim Length	Max. RPM	Standard Pack	Item Number
							Brass
1-1/2"	.005	3/8"	1/4"	7/16"	20,000	10	29178
2"	.005	1/2"	3/8"	1/2"	20,000	10	29059
	.0118						29086
3"	.014	1/2"	5/8"	1"	20,000	10	29078

For adapters and drive arbors see page 69.



17641

P CONFLEX BRUSH - Small diameter wheels permanently mounted onto a 1/4" stem to provide a very flexible brushing action.



Diameter	Wire Size	Face Width	Trim Length	Max. RPM	Standard Pack	Item Number
						Brass
3"	.0118	1/2"	1"	20,000	10	17641 ■

■ Packaged product available. See pages 136-139 for details.



13299

P KNOT WIRE CUP BRUSHES provide heavy-duty brushing action with some flexibility for more demanding cleaning applications on relatively flat surfaces.



Diameter	Wire Size	Arbor Hole	Trim Length	Max. RPM	Standard Pack	Item Number
						Bronze
2-3/4"	.020	5/8"-11 UNC	1"	14,000	1	13299
4"	.020	5/8"-11 UNC	1-1/4"	10,200	1	12776

For threaded arbor hole adapters see page 61.

P **CRIMPED WIRE CUP BRUSHES** provide a very flexible brushing action for light-duty cleaning applications on somewhat irregular surfaces.



Diameter	Wire Size	Arbor Hole	Trim Length	Max. RPM	Standard Pack	Item Number	
						Bronze	Brass
3"	.020	5/8"-11 UNC	7/8"	14,000	1	13231	—
4"	.020	5/8"-11 UNC	1-3/8"	10,200	1	14616	—
5"	.014	5/8"-11 UNC	1-1/4"	9,000	1	—	14606
6"	.020	5/8"-11 UNC	1-1/4"	6,600	1	14316*	—

* With internal nut For threaded arbor hole adapters see page 61.



13231

P **UTILITY CRIMPED WIRE CUP BRUSHES** - Smaller diameter cup brushes that provide a flexible brushing action for light-duty cleaning applications.



Diameter	Wire Size	Trim Length	Stem Diameter	Overall Length	Max. RPM	Standard Pack	Item Number
							Brass
1-3/4"	.006 .0118	3/4"	1/4"	2-5/16"	13,000	10	14310 • 14314
2-3/4"	.0118	7/8"	1/4"	2-1/2"	6,000	1	14311

• Non-stock product, contact Customer Service for lead times



14314

P **KNOT WIRE END BRUSH** features a hollow end and heavy-duty brushing action with some flexibility; ideal for more demanding cleaning applications in recessed areas.

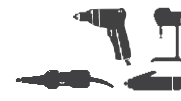

Diameter	Wire Size	Trim Length	Stem Diameter	Overall Length	Max. RPM	Standard Pack	Item Number
							Bronze
1-1/8"	.020	7/8"	1/4"	2-5/8"	22,000	10	10067



10067

P **CRIMPED WIRE END BRUSHES** feature a solid end and very flexible brushing action ideal for light-duty cleaning applications in corners and hard-to-reach areas.

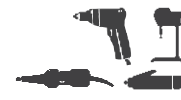

Diameter	Wire Size	Trim Length	Stem Diameter	Overall Length	Max. RPM	Standard Pack	Item Number
							Brass
1/2"	.005	7/8"	1/4"	2-9/16"	25,000	10	10158
1"	.005	7/8"	1/4"	2-5/8"	20,000	10	10128
1"	.0118	1"	1/4"	2-5/8"	22,000	10	10091



10158

P **DOUBLE STEM, DOUBLE SPIRAL POWER TUBE BRUSHES** - Constructed with four stem wires and a double spiral of straight wire fill material to provide a more aggressive internal cleaning action.



Diameter	Wire Size	Brush Part	Stem Diameter	Overall Length	Standard Pack	Item Number
						Brass
1/2"	.006	2"	5/32"	5"	10	21178
5/8"	.008	2"	7/32"	5"	10	21219
3/4"	.006	2-1/2"	1/4"	5-1/2"	10	21179
1"	.006	2-1/2"	1/4"	5-1/2"	10	21218



21178

P **ROUND POWER TUBE BRUSHES** feature a single continuous length of stainless steel stem wire and a single spiral of crimped wire fill for a more flexible brushing action; suitable for use on smooth or threaded blind holes.



Diameter	Wire Size	Brush Part	Stem Diameter	Overall Length	Standard Pack	Item Number
						Brass
1/4"	.004	1"	1/8"	3-1/2"	10	21332
1/2"	.005	1"	3/16"	3-1/2"	10	21182
1-1/2"	.008	1"	1/4"	3-1/2"	10	21152



21332

P **SINGLE STEM, SINGLE SPIRAL HAND TUBE BRUSHES** - Constructed using a single continuous length of galvanized steel stem wire and feature a formed eye loop for convenient hand use. The single spiral of straight wire fill allows for easy manual insertion into the ID.

Diameter	Wire Size	Brush Part	Stem Diameter	Overall Length	Standard Pack	Item Number
						Brass
3/16"	.003	1-1/2"	3/32"	7"	10	21221
1/4"	.003 .005	1-1/2"	3/32"	7"	10	21270 21139
3/8"	.004	2"	1/8"	8"	10	21191
1/2"	.004	2"	1/8"	8"	10	21165



21191

WHY WEILER

BONDED ABRASIVES

COATED ABRASIVES

NON-WOVEN ABRASIVES

POWER BRUSHES

NYLON BRUSHES

PACKAGED ITEMS

MAINTENANCE

STRIP BRUSHES



Straight strip brush used as a guard to prevent chips from flying.

METAL CHANNEL STRIP BRUSHES consist of natural, synthetic or wire bristles, held securely in place by a U-shaped metal channel and center wire, as illustrated. All Weiler brushes are first manufactured into a straight strip brush. The strip can then be coiled into cylinder brushes, or other shapes such as discs and cups. There are a variety of brush fills and virtually an infinite number of brush specifications within each metal channel size. All strip brushes are manufactured to our customers' individual requirements. This provides the proper filament stiffness, and allows for customers' unique modification of length and trim, enabling us to provide the ideal brush for the application.

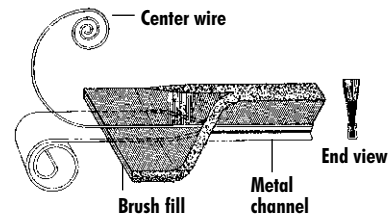

APPLICATIONS

- Spreading powdered materials
- Dusting tires, tile, paper, etc.
- Splash guard on grinders and machine tools
- Conveyor belt cleaning - assembled on hubs to form rotary brushes
- Lag brushes
- Eliminating static electricity
- Curtains to prevent chips from flying



GENERAL FIBER CHARACTERISTICS

Characteristic	6.6 Nylon	6.12 Nylon	Polypropylene	Horse Hair	Tampico
Heat Distortion (°F)	300	250	225	370	283
Melting Point	500	405	330	—	—
Bend Recovery (%)	90	90	70-80	excellent	poor
Shelf Life	excellent	excellent	good	poor	fair
Abrasion Resistance	excellent	excellent	good	good	poor
Specific Gravity (G/CC)	1.13-4	1.04-5	.90-1	1.3	.6
Tensile Strength (PSI)	60-70M	50-60M	50-80M	—	—

CHEMICAL AND ENVIRONMENTAL RESISTANCE

Characteristic	6.6 Nylon	6.12 Nylon	Polypropylene	Horse Hair	Tampico
Dilute Alkali	excellent	excellent	excellent	poor	good
Dilute Acids	good	good	excellent	poor	good
Strong Acids	fair	good	good	good-poor	good-poor
Alcohols	good	good	excellent	poor	good
Petroleum Distillates	excellent	excellent	good	poor	good
Hot Water	good	good	fair	poor	good
Alcohols, Vegetable Oils	good	good	excellent	poor	good

STRIP BRUSHES - STRAIGHT

Can be mounted on metal or wood back-up plates or on rotary hubs with machine or wood screws.



FILL MATERIALS

- Hair (horse, goat, etc.)
- Carbon steel
- Type 302 stainless steel
- Non-ferrous metals (brass, bronze, etc.)
- Nylon abrasive filament (Nylox®)
- Natural fibers (tampico)
- Synthetics (nylon, polypropylene)

STRIP BRUSHES - STRAIGHT

Metal Channel Size	Before Forming	After Forming (width x height)	Channel Materials			Max. OAH	Max. Bristle Diameter (nylon)	Max. Bristle Diameter (wire)
			Galvanized Steel	Stainless Steel				
				400 Series	300 Series			
#2.5	5/16" x .025	1/8 (.125) x 1/8" (.125)	XXX	XXX	—	1-1/2"	.012	.006*
#3	3/8" x .025	5/32" (.156) x 5/32" (.156)	XXX	XXX	—	3-1/2**	.014	.006*
#4	1/2" x .030	3/16" (.187) x 3/16" (.187)	XXX	XXX	XXX	4"	.025	.008
#5	5/8" X .040	7/32" (.218) X 1/4" (.250)	XXX	XXX	—	4-1/2"	.030	.008
#7	7/8" X .040	5/16" (.312) X 5/16" (.312)	XXX	XXX	XXX	6"	.050	.020
#10	1-1/4" X .050	7/16" (.437) X 7/16" (.437)	XXX	XXX	—	6"	.060	.020

* Available in brass or bronze only.

** Max. wire OAH 1-1/2".

STRAIGHT STRIP BRUSHES SPECIFICATIONS:

(Use the illustration on this page as a guide)

1. Overall brush height: _____
2. Overall brush length: _____
3. Channel size:
 - #2.5 #3 #4
 - #5 #7 #10
4. Channel material: Galvanized Steel Stainless Steel
5. Brush fill material:
 - Horsehair Nylon Carbon Steel Bronze
 - Polypropylene Brass 302 Stainless Tampico
 - Nylon Abrasive Filament (Nylox) Other _____
6. Fill material: Crimped Straight
 Diameter: _____ Color (if applicable): _____
7. Application: Wet Dry Operating Temp.: _____ °F
8. Quantity required: _____

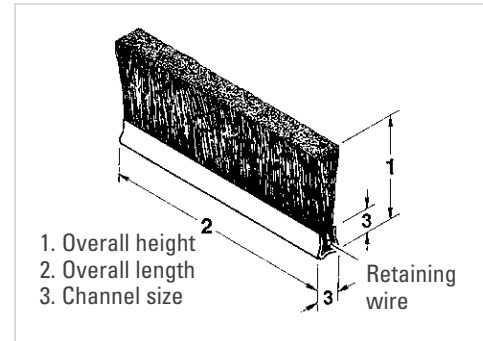

* Strip brushes are not returnable, as they are manufactured to order.

Name: _____
 Company Name: _____
 Address: _____
 Phone: (_____) _____
 Fax: (_____) _____
 E-mail: _____

End-User Name: _____
 City: _____
 State: _____ Zip: _____

FOR ADDITIONAL INFORMATION CALL:

Weiler's Application Engineering
 Hotline toll free at:
 888-299-APPS (2777)

FAX SPECIFICATION SHEET TO:

Application Engineering
 Fax: 800-635-3615

STRIP BRUSHES - COIL WOUND

Can be supplied as an unmounted refill coil, mounted on disposable tubing or wound on a customer's shaft.



FILL MATERIALS

- Hair (horse, goat, etc.)
- Carbon steel
- Type 302 stainless steel
- Non-ferrous metals (brass, bronze, etc.)
- Nylon abrasive filament (Nylox®)
- Natural fibers (tampico)
- Synthetics (nylon, polypropylene)

ALLIGATOR CLIPS - Use on #7 channel only. Coil Wound Strip Brushes can be supplied with alligator clips that have tabs at each end to be attached to customers' mandrel.



STRIP BRUSHES - COIL WOUND

Metal Channel Size	Before Forming	After Forming (width x height)	Channel Materials			Min. I.D.	Max. O.D.	Max. Bristle Dia. (nylon)	Max. Bristle Dia. (wire)
			Galvanized Steel	Stainless Steel					
				400 Seres	300 Seres				
#2.5	5/16" x .025	1/8 (.125) x 1/8" (.125)	XXX	XXX	-	3/8"	3-3/8"	.012	.006*
#3	3/8" x .025	5/32" (.156) x 5/32" (.156)	XXX	XXX	-	3/8"	7"	.014	.006*
#4	1/2" x .030	3/16" (.187) x 3/16" (.187)	XXX	XXX	XXX	1/2"	7"	.025	.008
#7	7/8" X .040	5/16" (.312) X 5/16" (.312)	XXX	XXX	XXX	1"	11"	.050	.020

* Available in brass or bronze only.

COIL WOUND STRIP BRUSHES SPECIFICATIONS:

(Use the illustration on this page as a guide)

- Outside diameter size _____
- Inside diameter size _____
- Brush face _____
- Channel size:
 - #2.5 #3 #4 #7
- Channel material: Galvanized Steel Stainless Steel
- Brush fill material:
 - Horsehair Nylon Carbon Steel Bronze
 - Polypropylene Brass 302 Stainless Tampico
 - Nylon Abrasive Filament (Nylox) Other _____
- Fill material: Crimped Straight
Diameter: _____ Color (if applicable): _____
- Close wound Open wound Specify pitch between spirals _____
- Mounting Clips: Yes No
- Application: Wet Dry Operating Temp.: _____°F
- Quantity required: _____

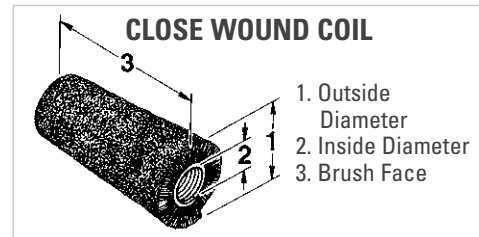
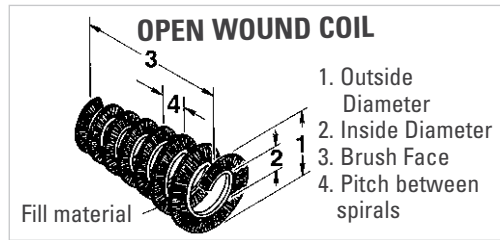

* Strip brushes are not returnable, as they are manufactured to order.

Name: _____
 Company Name: _____
 Address: _____
 Phone: (_____) _____
 Fax: (_____) _____
 E-mail: _____

End-User Name: _____
 City: _____
 State: _____ Zip: _____

FOR ADDITIONAL INFORMATION CALL:
 Weiler's Application Engineering
 Hotline toll free at:
 888-299-APPS (2777)

FAX SPECIFICATION SHEET TO:
 Application Engineering
 Fax: 800-635-3615



STRIP BRUSHES - DISC BRUSHES

Outside Disc: A circular single loop brush with the bristles facing OUTWARD, and the metal channel on the inside.

Inside Disc: A circular single loop brush with the bristles facing INWARD, and the metal channel on the outside.

STRIP BRUSHES - FORMED CUPS

These strip brushes are formed into a circle with the bristles facing down, commonly found in vacuum cleaning applications.



HOLDERS FOR METAL CHANNEL SIZE #2.5

Max. length 12'

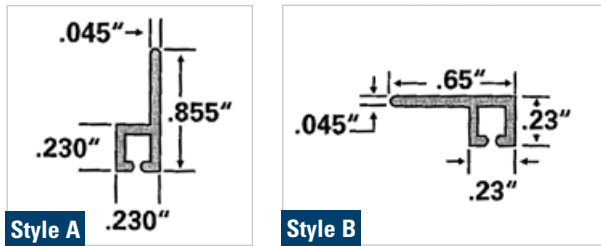

HOLDERS FOR METAL CHANNEL SIZE #4

Max. length 12'

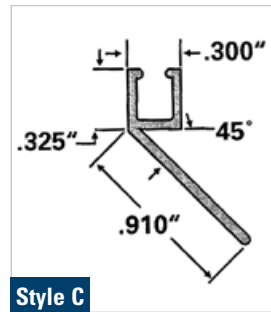
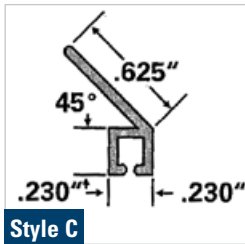
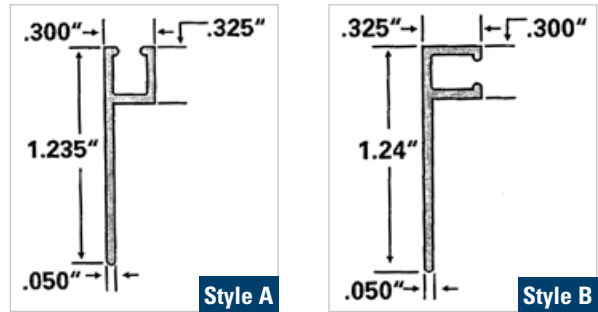

HOLDERS FOR METAL CHANNEL SIZE #7

Max. length 12'

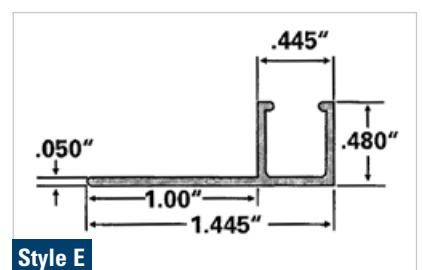
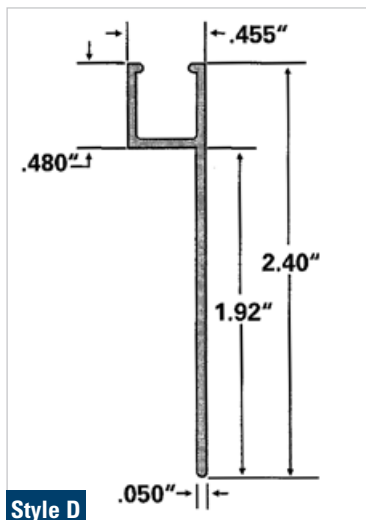
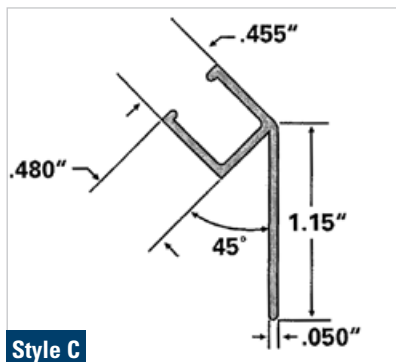
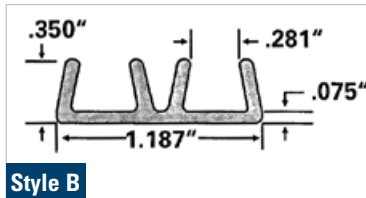
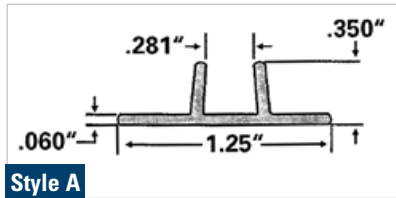

NOTE

All holder styles are constructed of aluminum

WIDE FACE BRUSHES



Removing light corrosion and mill scale from coiled steel.



Cylindrical brush assemblies have proven to be reliable and economical tools for a wide variety of industrial surface conditioning applications. In addition to gang-mounting a series of individual wheel brushes onto a shaft or reusable arbor, one-piece wide face brush units can be manufactured to cover broad surfaces or provide maximum brushing action in a minimum amount of space.

Cylindrical brushes can be manufactured using several different styles of construction, and the characteristics of each style of construction can significantly affect brush performance. Weiler will custom-design a wide face brush in the most appropriate type of construction for your specific application. Please call our Application Engineering Team at 888-299-APPS (2777) to discuss your requirements.

APPLICATIONS

- Scrubbing debris from the surface of material during processing
- Removing corrosion, surface contamination, mill scale, or heat discoloration
- Roughening surfaces to promote adhesion or bonding
- Removing applied finishes and coatings
- Producing decorative surface finishes
- Deburring or finishing cylindrical parts
- Deburring the cut ends of tubing and extrusions

DISPOSABLE BRUSH ASSEMBLIES - Wide face assemblies for brushing flat surfaces can be manufactured as disposable units with a variety of available fill materials depending on the specific application. Available fills include; metallic filaments such as steel, stainless steel, or brass crimped wire; Nylox® nylon abrasive filaments; synthetic filaments such as nylon or heat-stabilized polypropylene; or natural fibers such as tampico.

Disposable mountings can be constructed of carbon steel or stainless steel components, and “flow-through” mountings which allow coolant to be circulated through the core and out the face of the brush are available for wet applications.

REFILLABLE BRUSH ASSEMBLIES - Wide face assemblies for brushing flat surfaces can also be manufactured as a replaceable brush unit wound onto a permanent and reusable arbor. Depending on the specific application and production environment, refilling reusable arbors may be a more economical option than using disposable units. Reusable mountings can be designed by Weiler or supplied by the customer.

In addition to the secondary operations such as nibbling and grinding of the brush face and dynamic balancing of the completed unit, Weiler also offers maintenance services on mounting hardware like collars and bearings.

TUBE END DEBURRING BRUSHES - Cylindrical rotary brushes are an ideal media for production applications involving the batch deburring of the ends of tubing that has been cut-to-length. Automated brushing systems are readily available and considerably less expensive to purchase and operate than chamfering machines.

Brush deburring machines can be integrated with cut-off operations to eliminate work-in-process and increase throughput, and they are flexible enough to be quickly adjusted for various shapes, sizes, and lengths of tubing. Unlike chamfering operations, brush deburring does not leave secondary burrs, brushing equipment is more tolerant of slight variations in machine set-up and tube length, and quality brushes last much longer than cutting inserts on double-end finishers.

Tube end deburring brushes are most commonly manufactured as disposable assemblies that are then mounted onto keyed shafts. High-tensile steel, hard-drawn steel, and Type 302 stainless steel wire are the most common fill materials used in tube end deburring brushes. Weiler offers high quality brushes with wire sizes from .006 to .020 and four available levels of fill density so that the brushing performance can be tailored to the material, burr condition, and budget of the end-user.

CUSTOM TUBE END DEBURRING BRUSHES - Please use the appropriate specification sheet on the next page when requesting a quotation on a custom tube end deburring brush.

NEED HELP?

Call our Application Engineering Hotline at 888-299-APPS (2777). If the problem is too complex to be solved over the phone, we will determine if an evaluation should be conducted at our in-house lab or your facility. Either way, Weiler will provide the most cost-effective solution for your specific application.

BRUSH-TUBE ORIENTATION

Brush-tube orientation determines which edges of the tube are deburred. The illustrations below show three orientations and the target edge.

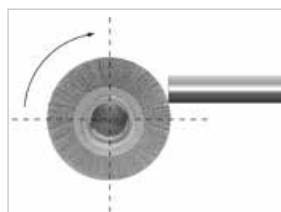

Deburring Tube I.D.

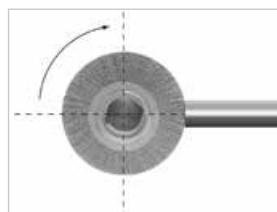

Deburring Tube I.D. and O.D.

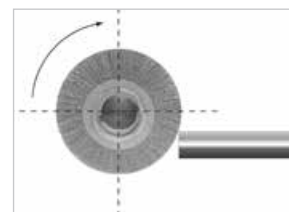

Deburring Tube O.D.

WIDE FACE BRUSH SPECIFICATION SHEET:

To help us accurately quote a wide face brush for your application, please provide the following information:

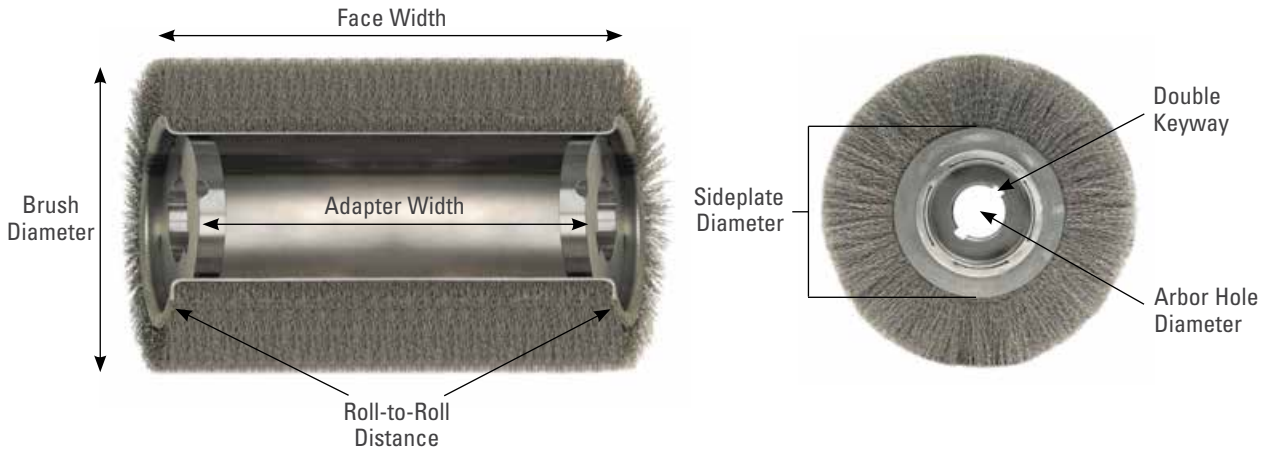

_____ Brush Diameter (Note: Tolerance is +/- 1/16")

_____ Fill Material _____ Fill Diameter

Fill Density: Economy General Purpose Heavy-Duty High Performance

_____ Face Width (Note: Tolerance is +/- 1/4")

_____ Roll-to-Roll Distance - Through Arbor Dimension (Note: Tolerance is +/- 1/8")

Brush can be manufactured holding the face width dimension or the roll-to-roll distance, not both.

_____ Sideplate Diameter

Standard sizes:

6" brush = 3-3/4" O.D.

8" brush = 5-1/4", 5-1/2" or 6-1/2" O.D.

>8" brush = 5-1/2" or 6-1/2" O.D.

_____ Maximum Operating RPM

_____ Adapter Width (Note: Adapters are 1/2" thick, tolerance on width spacing is +/- 1/8")

_____ Arbor Hole Diameter (Note: Clearance of 0.003" with additional tolerance of + 0.004" - 0 will be added)

Keyway(s) Required Single Double Keyway Width _____ Keyway Depth _____

Intended Brush Use: _____

Name: _____

End-User Name: _____

Company Name: _____

City: _____

Address: _____

State: _____ Zip: _____

Phone: (_____) _____

Fax: (_____) _____

E-mail: _____

FOR ADDITIONAL INFORMATION CALL:

Weiler's Application Engineering
Hotline toll free at:
888-299-APPS (2777)

FAX SPECIFICATION SHEET TO:

Application Engineering
Fax: 800-635-3615

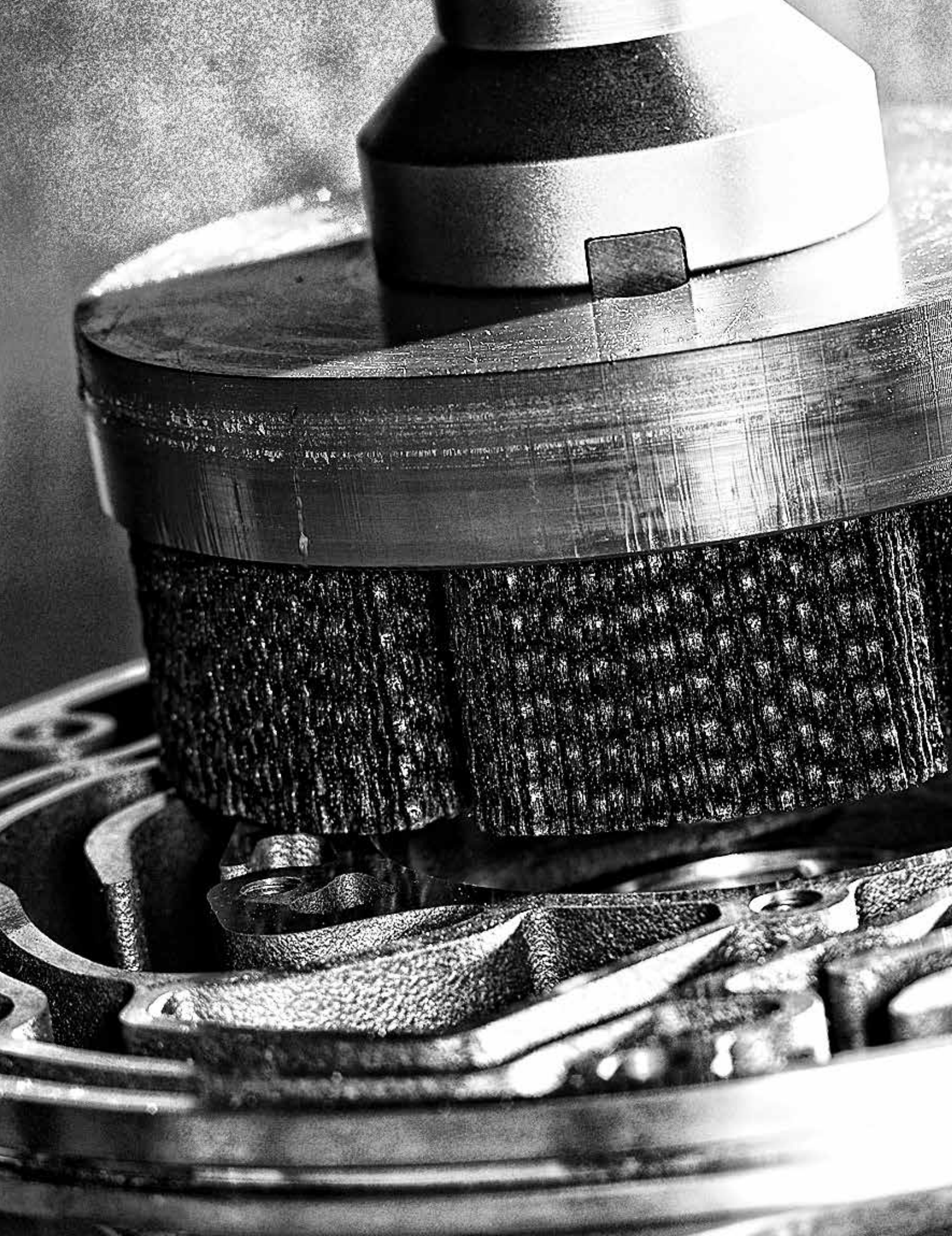



INCREASE PRODUCTIVITY

Combining cutting-edge technology and product innovation, Nylox abrasive nylon filament brushes were developed to provide increased productivity, thereby cutting production costs. Nylox brushes were specifically designed as flexible deburring and edge radiusing tools for CNC, robotic and automated processes.

The nylon filaments of these brushes are impregnated with abrasive grain. As the nylon wears, new sharp grains are constantly exposed to the work surface, enabling the brush to maintain consistent brushing action throughout its life.

Technical Information	102-110
Engineered Products & Solutions	111
Troubleshooting Guide	112
Small Feature Deburring Products	113-117
Flat Surface Deburring Products	118-121
Targeted Feature Deburring Products	122-124
Application Engineered Wheels	125
Adapters & Drive Arbors	126-127
FME Area Product Solutions	128

MYLOX[®]

BRUSHES

SOLUTIONS SHOWCASE

TRANSMISSION VALVE BODY

Problem: Burrs on transmission components can break away from parent components during use and cause transmission wear and eventual failure. Therefore, fluid passages must be completely burr-free.

Solution: A 10" Nylox® disc brush operating at 825 RPM in a vertical CNC machining center is an ideal solution for deburring this component. Since all of the burrs are on a single plane, the non-directional nature of a Nylox disc brush produces a part on which all edges have been uniformly deburred.

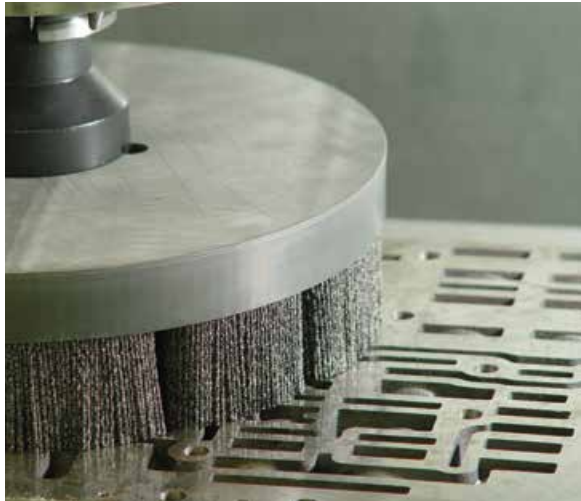

STEERING COMPONENT

Problem: Manual deburring can be costly in many respects. Hard deburring tools and aggressive abrasive wheels do not allow much margin for operator error and the result is often high scrap rates.

Solution: Nylox brushes produce a flexible filing action that concentrates all of the abrasive cutting action on sharp edges, giving them the ability to remove burrs without altering overall part dimensions. For example, a 6" Burr-Rx® wheel mounted onto a 1,725 RPM pedestal buffer is capable of deburring this steering component just as quickly as a convolute wheel but without the fear of over-radiusing the edges of the teeth or producing flat spots.

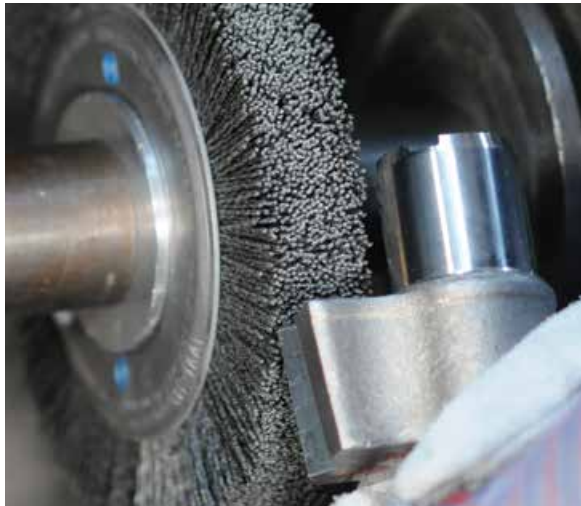

TOOL STEEL DEBURRING

Problem: Traditional nylon abrasive brushes were not sufficiently aggressive to remove large burrs from materials like tool steels and stainless steels.

Solution: Weiler's next generation filament technology, embodied in the company's line of Burr-Rx brushes, creates sufficient aggression to handle the toughest deburring jobs. This enables more users to capture the benefits offered by in-machine deburring.

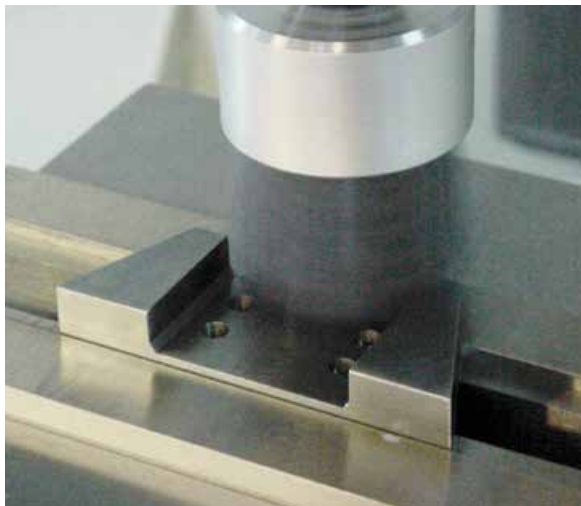

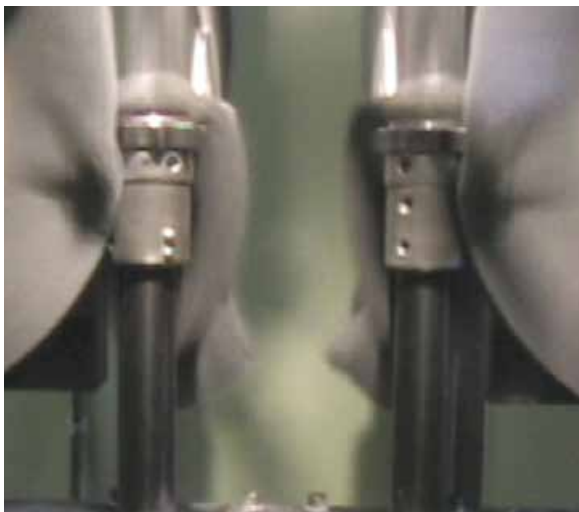

PUMP GEAR

Problem: Pumps are extremely susceptible to failure due to burrs. Due to the tight fit between components, all edges must be deburred and radiused to ensure proper function. Proper deburring of rotating pump gears is especially important.

Solution: A dedicated machine running 14" Nylox® wheel brushes at 900 RPM was a low-cost solution for deburring these gears. By using dedicated equipment, cycle time was minimized and an acceptable edge condition was achieved.



CAST ALUMINUM HOUSING

Problem: Although deburring the face-milled surfaces of castings is a very straight forward application for Nylox disc brushes, the limited availability of valuable machine time can be a perceived obstacle that prevents users from reaping the many benefits of implementing in-machine deburring operations.

Solution: The advanced ceramic grain technology of Weiler's Burr-Rx® tools offer a deburring action that is up to 400% greater than traditional abrasive nylon brushes that contain silicon carbide or aluminum oxide filaments. This allows Burr-Rx deburring tools to be used at feed rates that dramatically reduce the amount of additional machine time required to perform a brushing operation.



TURBINE BLADE

Problem: Protecting turbine engine components against high-temperature fatigue is critical to ensure safe, reliable engine operation. Component edges must be burr-free and generally require an edge radius in the range of 0.005" to 0.060".

Solution: Robots are extremely well-suited for this application because they can manipulate the component in many orientations in relation to the brush. Weiler works closely with users and robot integrators to develop products and process programs that maximize brush life while generating exceptional part quality and consistency.

Photo courtesy of ACME Manufacturing.

SELECTING THE RIGHT BRUSH



WHERE TO START?

Sometimes it's necessary to design and manufacture a unique, custom-tailored product to meet your application requirements. Although Weiler offers such engineered solutions in all of our product lines, the innovative construction and value-added nature of the Nylox® line of nylon abrasive filament brushes showcases the creativity and expertise of our Application Engineering Team in designing products that have been tailored to the needs of the customer.

- Custom-engineered Nylox brushes can be designed and manufactured as variations on our standard products.
- Wide face brush assemblies for finishing flat surfaces or deburring cylindrical parts can also be designed and manufactured using Nylox nylon abrasive filaments. (See pages 100-101 for more information)

FOR SOLUTIONS TO DIFFICULT APPLICATIONS

Call our Application Engineering Hotline at 888-299-APPS (2777).

If the problem is too complex to be solved over the phone, we will determine if an evaluation should be conducted at our in-house lab or the user's facility.

TRIM LENGTH AND FILL DENSITY

To maximize brush life and reduce costs, always use the shortest trim, highest density brush that will adequately conform to the surface or part edges.

LONG TRIM, LOW DENSITY

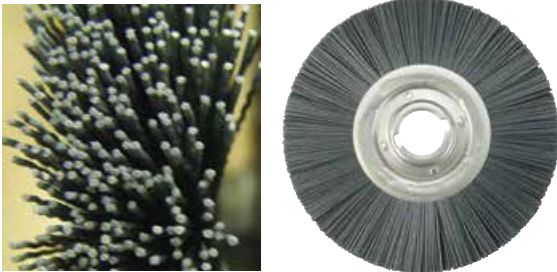

These brushes offer a greater degree of flexibility that is ideal for applications requiring a high degree of brush conformability. However, the lower fill density can result in shorter brush life and less consistent performance.

SHORT TRIM, HIGH DENSITY



These brushes work with a faster action and less engagement with the brush face. This produces shorter cycle times, more consistent performance and longer life in applications that do not require a high degree of brush conformability.

GRIT SIZE COLORS

Grit size is indicated by a dot on the product with the following colors:

- | | | | |
|-----------------------|------------------------|-----------------------|--------------------------|
| Black 46 Grit | Green 120 Grit | Gold 200 Grit | Purple 600 Grit |
| Red 60 Grit | Grey 180 Grit | White 320 Grit | Blue 1000 Grit |
| Yellow 80 Grit | Orange 240 Grit | Brown 500 Grit | Lt. Blue 800 Grit |
| | | | Pink 1200 Grit |

Refer to ANSI B7.1 for storage & handling details

PRODUCT ADVANTAGES

PRODUCT ADVANTAGES

AGGRESSIVE YET COMPLIANT



- Nylox® brushes do not alter the overall dimensions or geometry of a part.
- Filament compliance allows these brushes to conform to complex part shapes and reduces the need for ultra-precise programming and fixturing.

IDEAL FOR AUTOMATION



- Abrasive grain is evenly distributed throughout the nylon filament.
- Extremely consistent performance throughout their product life.
- Ideal media for use in automated deburring and finishing processes.
- Ideal for dedicated production equipment or robotic cells.
- Can be directly integrated into the cycle of CNC machining centers.
- Improve part quality and consistency.
- Reduce direct labor cost.

IDEAL FOR DEBURRING

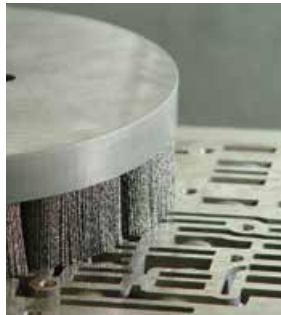

- Nylox filaments act like flexible files, deburring and radiusing edges as they wipe across them.
- Their limited aggression and flexible filing action also make them suitable for deburring a wider range of materials in comparison to wire-filled power brushes.

ENHANCED SURFACE FINISHES



- The compliant cutting action not only limits their ability to alter part dimensions, but it makes them an effective tool for refining surface texture characteristics without removing significant amounts of base material.
- Although they contain the same abrasive grain sizes, Nylox brushes will not generate the same prominent scratch pattern as a comparable coated abrasive product.

CONSTRUCTION ADVANTAGES

COMPETITOR'S METAL HUB

- Metal hub components are assembled under high pressure, potentially damaging the filaments and causing premature breakage.
- Retaining ring displaces filament material, creating a void in the center of the brush face.
- Lower fill density can result in shorter life and less consistent performance.



WEILER'S COMPOSITE HUB

- Molded hub construction eliminates filament breakage.
- Uniform distribution of fill material and superior balance.
- Higher fill density provides more aggressive brushing and longer life.
- Consistent performance as the brush wears.



WEILER'S COMPOSITE METAL HUB

- Filaments retained using the latest polymer technology to prevent filament breakage.
- Metal components add impact resistance and dimensional stability.
- The highest filament density in the market ensures lowest cost-per-part.



WEILER'S PVC SHELL MILL

The PVC construction results in a very consistent, flat brush face. Their high dimensional precision makes them suitable for the most critical applications. They perform more consistently from the first part to the last.



WEILER'S TUFTED FILAMENTS

This construction style offers increased aggression due to added filament density. This enables processing of severe burrs or generating larger edge radii in shorter cycle times. The longer trim length allows for greater conformability and longer life.

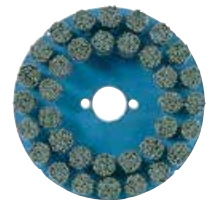

WEILER'S MAXIMUM DENSITY

Maximum density brushes are uniquely suited for demanding applications characterized by large burrs and rapid feed rates.



WHY WEILER

BONDED ABRASIVES

COATED ABRASIVES

NON-WOVEN ABRASIVES

POWER BRUSHES

NYLOX BRUSHES

PACKAGED ITEMS

MAINTENANCE

PRODUCT CHARACTERISTICS

WHEEL BRUSHES

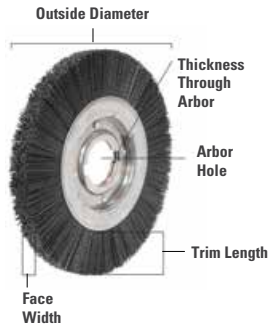

- Precision deburring of component parts after machining or grinding.
- Improving surface texture on machined or ground surfaces.
- Honing cutting tools and generating specific edge profiles and radii.
- Light duty cleaning and finishing of metals; light sanding of woods and composites.



DISC BRUSHES



- Deburring flat surfaces on machined components.
- Improving texture on machined or ground surfaces.
- Deburring face-milled castings or forgings.
- Blending tool marks after machining or grinding.



END BRUSHES



- Deburring flat surfaces on machined components.
- Improving texture on machined or ground surfaces.
- Deburring face-milled castings or forgings.
- Blending tool marks after machining or grinding.



TUBE BRUSHES

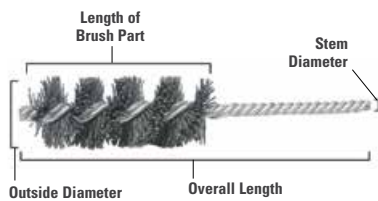

- Deburring and finishing applications in tubular component parts, drilled and tapered holes and machined bores and passages.



CROSSHOLE DEBURRING BRUSHES



- Deburring internal edges.
- Improving surface texture on internal bores.



FILAMENT CONFIGURATIONS

ROUND FILAMENTS - Due to their cross-sectional shape and the reduced contact with the work surface or part edges that result, round filaments provide a more compliant brushing action for less aggression and enhanced conformability.

RECTANGULAR FILAMENTS - Due to their shape, larger cross-sectional area and increased contact with the work, rectangular filaments provide a less compliant brushing action for much greater aggression and reduced conformability.

Crimping either type of filament along its length enhances conformability, allowing greater penetration of part edges into the brush face, often increases aggression. Crimped filaments are especially beneficial in maximum density disc brush designs.

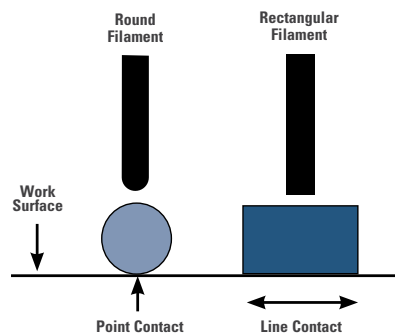

ABRASIVE FILAMENTS

Abrasive brush filaments are manufactured by extruding a mixture of liquefied polymer and abrasive grain. Unlike the filaments used in DIY grade abrasive brushes, industrial grade products like Weiler's Nylox® and Burr-Rx® brushes feature the highest grade of abrasive filament manufactured using a Type 6.12 nylon polymer. Industrial grade filaments also feature the highest quality abrasive materials that have been sifted and sorted to ensure that the grains are consistent in size. These grains may be one of four different types of abrasive:

- **ALUMINUM OXIDE (AO)** - is a duller, less aggressive grain typically used in finishing applications requiring a less pronounced scratch line pattern or deburring applications on materials where the use of SiC may be prohibited
- **BURR-RX CERAMIC (CG)** is an engineered abrasive grain that produces a superior cutting action and is compatible with the widest range of materials. It is the most effective grain available today!
- **SILICON CARBIDE (SIC)** is a sharp-edged grain that produces an effective cutting action. It is the most common grain used in industrial grade brushes.
- **DIAMOND FILAMENT** is a sharp-edged grain typically used for producing edge radii on hard materials like diamond, ceramic, CBN and glass.

ADVANTAGES OF BURR®-RX CERAMIC

Nylox brushes containing the Burr-Rx black ceramic filament provide the following advantages over SiC and AO filaments.

- 400% greater cutting action
- Most cost-effective deburring brush
- Deburr tougher materials
- Minimize cycle time
- Maximize tool life
- Reduce finishing costs
- Eliminate hand deburring

DEBURRING ACTION - BURR-RX (CG VS. SIC)

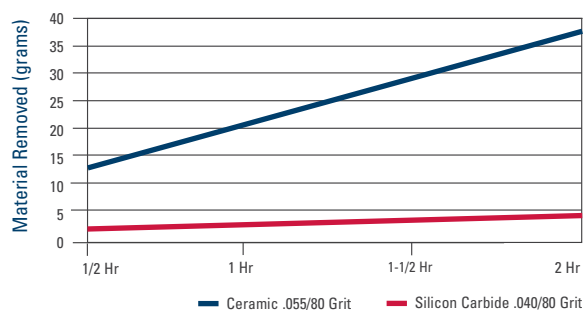

WHEEL VS. DISC BRUSH



Nylox wheel brushes are for applications where a targeted brushing action is required.



Disc brushes are for applications where the burrs lie along a single plane.

OPERATING INFORMATION

OPERATING PARAMETERS

Nylox® abrasive brushes work with a wiping and filing action. Think of them as flexible files. The sides of the Nylox filament actually do the work. To achieve a maximum edge radius and complete burr removal, parts should be buried into a slow running brush face. They work best when operated at speeds that allow

fairly deep penetration of the work-piece into the brush filaments. Usually, faster speeds do not work as well as slower speeds. The maximum RPM marked on the brush is not the optimum working speed. A good rule of thumb is to stay under 2,500 SFPM in dry applications and 3,500 SFPM in wet applications.

WHEEL BRUSHES

PENETRATE 10% OF TRIM LENGTH



DISC BRUSHES

0.075" - 0.100" DEPTH OF INTERFERENCE

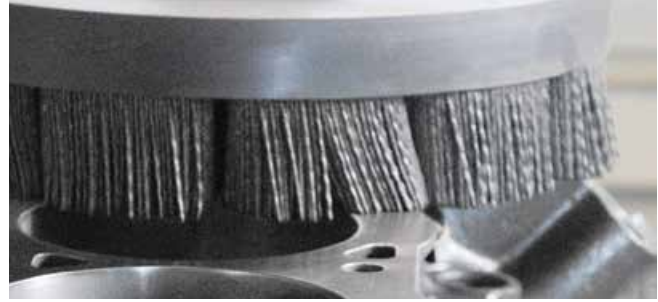

OPERATING SPEEDS - WHEEL BRUSHES

Diameter	RPM
2"	3,450 - 5,000
3"	2,500 - 3,450
4"	1,750 - 2,500
6"	1,350 - 1,750
8"	1,150 - 1,350
10"	950 - 1,150
12"	750 - 950
14"	650 - 850

OPERATING SPEEDS - DISC BRUSHES

Diameter	RPM
1-3/4" & 2"	1,750 - 2,000
3"-4"	1,500 - 1,750
5" - 6"	1,250 - 1,500
8"	800 - 1,000
10"	700 - 800
12"	600 - 700
14"	500 - 600

FEED RATE is determined by the amount of deburring, edge radiusing or surface finishing required and the type of material that is being processed. It is generally application specific. Slower feeds result in a more aggressive brushing action. Based on the brushing action desired for a specific application, the feed rate can be increased or decreased.

Material	SiC and AO Grain Feed Rate	Burr-Rx Grain Feed Rate
Non-Ferrous	50 in./min.	80 in./min.
Cast Iron	30 in./min.	60 in./min.
Mild Steel and Ductile Iron	25 in./min.	50 in./min.
Stainless and Alloy Steels	15 in./min.	30 in./min.
Titanium and High Nickel Alloys	10 in./min.	30 in./min.

RECOMMENDED MOTOR SIZES

Brush Diameter	Motor Size	RPM*
3"-4"	1/4 HP	3,450
6"	1/2 HP	1,725
8"	3/4 HP	1,725
10"	1 HP	1,140
12"	1 HP	1,140
14"	1-1/2 HP	900

Note: This chart is based on 1" brush face.

* A variable-speed motor control may be required to achieve optimum operating RPM; see operating speed charts above.

MINIMUM RECOMMENDED SPINDLE DIAMETER (from ANSI Standard B165.1)

Outside Dia. of Wheel Brush	Maximum Face Width of Wheel Brush	Minimum Outside Dia. of Spindle (Shaft)
2"	1/4"	1/4"
3"	3/4"	1/4"
3" (heavy-duty)	1"	3/8"
4"	1"	3/8"
6"	1-1/4"	1/2"
8"	1-1/4"	5/8"
10"	2"	3/4"
12"	3"	1"
14"	3"	1-1/4"
15"	3"	2"
16"	3"	2"

Note: These diameters are based on the wheel brush being mounted next to the supported end of the shaft rather than the unsupported end in order to minimize overhang.

COOLANT & WEAR COMPENSATION

COOLANTS

Nylox® brushes can be run dry, without coolants. However, certain deburring conditions such as higher speeds, material properties and greater depth of penetration can create excessive heat buildup, causing the nylon filaments to melt and smear on the work surface. If the speed or depth of penetration cannot be changed, coolants are recommended to overcome heat smear. Coolants will also help produce finer finishes.

WEAR COMPENSATION

On dedicated equipment, it is possible to automate wear compensation by using electronic controls to monitor the load on drive motors and adjust the position of the brushing tool to maintain a relatively consistent amount of interference or pressure. Since this is typically not possible with standard CNC machine tools, there are three other possible methods of compensating for tool wear for “in-machine” implementations of Nylox brushes.

AUTOMATIC INDEXING

Most CNC controllers allow tool wear compensation to be accomplished by programming a “macro” - routine to periodically adjust the position of the tool based upon the number of parts produced. Some experimentation may be required to determine the frequency and amount of adjustment that will result for most consistent performance and maximum brush life.

PROBING

If the machining center has the capability to probe the face of the brush, this feature can be used to gauge the true position of the filament tips. Adjustments to the brush position can then be made to maintain a consistent amount of interference between the tool and the part.

MANUAL

If the other methods cannot possibly be used, machine operators can adjust the brush position based on either statistical process control data or visual inspection of completed parts.

THE IDEAL TOOL PATH for a Nylox Disc brush is very similar to the path of the face mill that produced the burr. However, three differences exist:

- The rotation direction of the brush should be opposite of the cutting tool that created the burr.
- The length of the path must be longer than the part. Unlike a cutter path that can stop when the leading edge of the cutter reaches the end of the part, the tool path of a brush should continue until the trailing edge of the brush reaches the end of the part.
- The centerline of the brush may need to be off-set from the center of the part in order to maximize the number of filaments that strike the part at a perpendicular angle. This is especially important when the diameter of the brush is similar to the width of the part.

The part is deburred in the shortest cycle time with the lowest consumable cost-per-part.

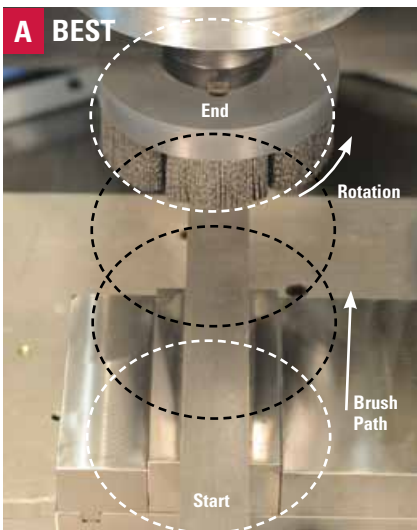

If a large diameter brush can be used, the centerline of the brush should be positioned on the center of the part. Ideally, the brush should be 3-4" wider than the part.

The part is deburred, but requires a longer cycle time. When a large brush will not fit in the tool changer, this method is recommended.

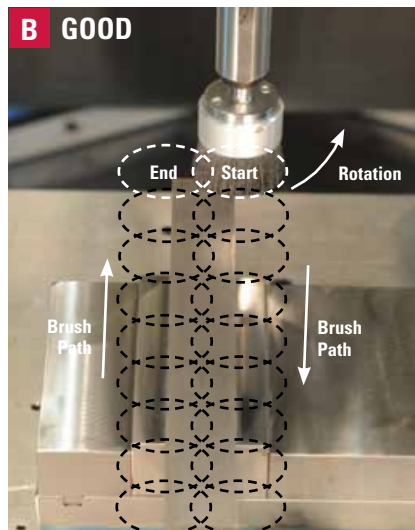

If a small diameter brush must be used, the centerline of the brush should be positioned on the edge of the part. This maximizes aggression by increasing the amount of perpendicular contact between the brush filaments and the burred edge.

Produces less deburring than A & B.

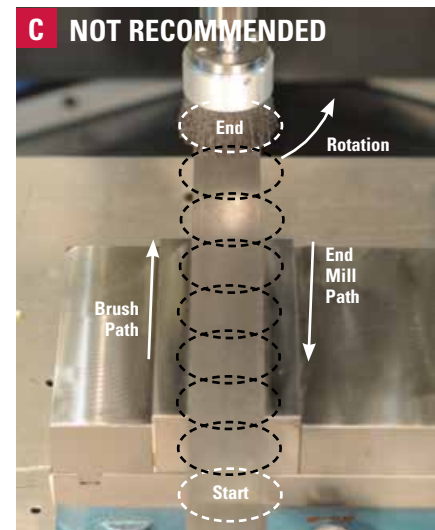

Positioning a small diameter brush with its centerline on the center of the part is not recommended. This configuration will not allow perpendicular contact of the filaments against the burred edge.

COOLANT COMPATIBILITY



NYLOX® BRUSHES IN AUTOMATED ENVIRONMENTS

MYTH: The abrasive grain in the Nylox brush will affect the accuracy of the equipment over time.

FACT: The abrasive grain in the Nylox brushes will not result in accelerated machine wear over time when used with proper filtration (50-micron or finer).

Automotive Case Study

In the auto industry a five year study was conducted on the use of Weiler Nylox brushes with silicon carbide (SiC) grain in the manufacturing of aluminum intake and exhaust manifolds. Over the period of the study, there was no noticeable difference in way wear between machines that ran brushes and those that did not. A 50-micron coolant filter worked as specified to remove the residuals from the brushing process.

Aerospace Case Study

A three year study was conducted on the use of Weiler Nylox brushes with ceramic grain (CG) in the manufacture of jet engine components. Over the period of the study, there was no loss in accuracy in the aerospace manufacturer's machines. A 50-micron coolant filter worked as specified to remove the residuals from the brushing process.



ENGINEERED PRODUCTS AND CUSTOMIZED SOLUTIONS



Two members of our Application Engineering Team discuss the results after testing an engineered product.

WE PROVIDE YOU WITH THE MOST COST-EFFECTIVE APPLICATION SOLUTIONS

Sometimes it is necessary to design and manufacture a unique, custom tailored product to meet your application requirements. Although Weiler offers such engineered solutions in all of our product lines, the innovative construction and value-added nature of the Nylox® line of nylon abrasive filament brushes showcases the creativity and expertise of our Application Engineering Team in designing products that have been tailored to the needs of the customer.

- Custom-engineered Nylox brushes can be designed and manufactured as variations on standard product configurations such as wheel, disc, cup, end, or tube brushes.
- Weiler's exclusive Burr-Rx® and Bore-Rx™ brushing tools can be engineered to meet the demands of a specific application.
- Wide face brush assemblies for applications such as finishing flat surfaces or deburring cylindrical parts can also be designed and manufactured using Nylox nylon abrasive filaments. (See pages 94-95 for more information)

FOR SOLUTIONS TO DIFFICULT APPLICATIONS

Call our Application Engineering Hotline at 888-299-APPS (2777).

If the problem is too complex to be solved over the phone, we will determine if an evaluation should be conducted at our in-house lab or the user's facility.



TROUBLESHOOTING GUIDE

There are many variables in Nylox® applications. If the Nylox brush you are using does not accomplish the desired results, select a solution from the suggestions below for your specific application or call Weiler's Application Engineering Hotline at 888-299-APPS (2777).

Problem	Recommended Solutions
Brush not aggressive enough	<ul style="list-style-type: none">• Increase filament diameter and/or grit size• Increase filament density by using round straight rather than round crimped• Increase surface contact by using rectangular rather than round• Increase pressure/depth of interference• Increase surface speed by increasing spindle RPM• Use a larger diameter brush• Reduce trim length or feed rate
Brush too aggressive	<ul style="list-style-type: none">• Reduce filament diameter and/or grit size• Reduce filament density by using round crimped rather than round straight• Reduce surface contact by using round rather than rectangular• Reduce pressure/depth of interference• Reduce surface speed by reducing spindle RPM• Use a smaller diameter brush• Increase trim length or feed rate
Brush not conformable enough	<ul style="list-style-type: none">• Increase trim length• Reduce filament diameter• Reduce filament density by using round crimped rather than round straight or rectangular• Reduce surface speed by reducing spindle RPM• Reduce feed rate
Finer final finish required	<ul style="list-style-type: none">• Increase surface speed by increasing spindle RPM• Decrease grit size• Use brush with a coolant
Coarser final finish required	<ul style="list-style-type: none">• Reduce surface speed by reducing spindle RPM• Increase grit size• Use brush without a coolant
Filaments melt/smear on workpiece	<ul style="list-style-type: none">• Reduce surface speed by reducing spindle RPM• Use a smaller diameter brush• Use brush with a coolant
Short brush life	<ul style="list-style-type: none">• Increase filament density• Reduce pressure/depth of interference

NEED HELP?

Call our Application Engineering Hotline at 888-299-APPS (2777). If the problem is too complex to be solved over the phone, we will determine if an evaluation should be conducted at our in-house lab or your facility. Either way, Weiler will provide the most cost-effective solution for your specific application.

SMALL FEATURE DEBURRING PRODUCTS

SMALL DIAMETER WHEELS

MADE IN USA

Ideal for recesses and internal features or delivering targeted brushing action to a specific area. Our Burr-Rx® black ceramic grain filament wheels deliver up to a 400% greater edge-cutting action compared to traditional silicon carbide and aluminum oxide filaments for the fastest, most aggressive action for minimum cycle times and maximum life.

APPLICATIONS

- Deburring keyways, slots and crosshole intersections
- Honing and finishing of cylindrical bores

BURR-RX® SMALL DIAMETER WHEELS - Metal Hub - Crimped Round Black Ceramic Filament

Diameter	Filament Dia./Grit	Arbor Hole	Face Width	Trim Length	Max. RPM	Standard Pack	Item Number
1-1/4"	.026/120	1/4"	5/16"	5/16"	10,000	10	17551
1-1/2"	.026/120	1/2"	3/8"	1/4"	10,000	10	17541
2"	.026/120	1/2"	3/8"	1/2"	10,000	10	17548
	.035/80						17555
2-1/2"	.026/120	5/8"	1/2"	11/16"	10,000	10	17556
	.035/80						17557
3"	.026/120	1/2"	1/2"	1"	10,000	10	17565
	.035/80						17567
	.043/120						17568

Other diameters and grit sizes available upon request.

SMALL DIAMETER WHEELS - Metal Hub - Crimped Round Silicon Carbide Filament

Diameter	Filament Dia./Grit	Arbor Hole	Face Width	Trim Length	Max. RPM	Standard Pack	Item Number
1-1/8"	.022/120	1/4"	5/16"	1/4"	10,000	10	17532 •
1-1/4"	.022/120	1/4"	5/16"	5/16"	10,000	10	17535
1-3/8"	.018/500	1/4"	5/16"	3/8"	10,000	10	16310*
1-1/2"	.022/120	1/2"	3/8"	1/4"	10,000	10	17628
	.035/180						29353
2"	.018/500	1/2"	3/8"	1/2"	10,000	10	17533
	.022/320						17543
	.040/120						17633
2"	.022/120	5/8"	7/16"	7/16"	10,000	10	17629
	.022/320						29356
2-1/2"	.022/120	5/8"	1/2"	11/16"	10,000	10	29123
	.035/180						29280 •
	.040/120						29088
3"	.035/180	1/2"	1/2"	1"	10,000	10	17563
	.022/320						16315
	.040/120						16263

Other diameters and grit sizes available upon request.

Aluminum oxide*

• Non-stock product, contact Customer Service for lead times

DRIVE ARBORS - For mounting small diameter wheels into a collet or chuck.



Arbor Diameter	Stem Diameter	Stem Length	Length of Shaft	For Brushes with Max. Dia. of	Overall Length	Max. RPM	Standard Pack	Item Number
Unthreaded Shaft								
1/4"	1/4"	1-1/8"	3/16"	2"	2-1/16"	20,000	5	07723
Threaded Shaft								
1/2"	1/4"	3/4"	3/4"	3"	1-3/4"	25,000	5	07724
5/8"	1/4"	3/4"	3/4"	3"	1-13/16"	25,000	5	07729
1/2"	1/4"	7/8"	3/4"	3"	1-11/16"	20,000	5	07721
1/4"	1/4"	1-1/16"	1-1/8"	2"	2-9/16"	20,000	5	07725

PLASTIC ADAPTERS for mounting small diameter wheels onto various arbor sizes.

Fixed Arbor Hole Size	Adapted Arbor Hole Size	Standard Pack	Item Number
1/2"	1/4"	10	04400
1/2"	3/8"	10	04401
5/8"	1/2"	10	04402



Deburring the edges of a machined aluminum component.



17568



17533



07723



07724



07729



07721



07725



04401



04402

NOTE

See adapters on pages 126-127

COATED ABRASIVES

NON-WOVEN ABRASIVES

POWER BRUSHES

NYLON BRUSHES

PACKAGED ITEMS

MAINTENANCE



Deburring small features on a powdered metal part.

END BRUSHES



Featuring an integral stem for convenient mounting into a tool holder or collet, Nylox® end brushes and miniature end brushes are suitable for addressing recesses and internal features, or delivering a targeted brushing action to a specific area on a part.

APPLICATIONS

- Deburring small recessed areas and internal part features
- Finishing slots and recessed surfaces on machined parts

BURR-RX® END BRUSHES - Banded - Crimped Round Black Ceramic Filament - Mounted on 1/4" Stems



86104

Diameter	Filament Dia./Grit	Trim Length*	Recommended RPM	Overall Length	Max. RPM	Standard Pack	Item Number
3/8"	.026/120	1/4"	4,500 - 5,000	2-3/8"	10,000	10	86098
	.043/120						86099
1/2"	.026/120	1/4"	4,500 - 5,000	2-7/16"	10,000	10	86100
	.043/120						86101
3/4"	.026/120	1/4"	4,200 - 5,000	2-7/16"	10,000	10	86102
	.043/120						86103
1"	.026/120	1/4"	3,500 - 3,800	2-5/8"	10,000	10	86104
	.043/120						86105
	.055/80						86097

* Trim length from bands

END BRUSHES - Banded - Crimped Round Silicon Carbide Filament - Mounted on 1/4" Stems



11166

Diameter	Filament Dia./Grit	Trim Length*	Overall Length	Max. RPM	Standard Pack	Item Number
1/2"	.022/320	3/8"	2-9/16"	10,000	10	11160
	.035/180					11161
	.040/120					11162
3/4"	.035/180	3/8"	2-7/16"	10,000	10	11165
	.040/120					11166
1"	.035/180	3/8"	2-11/16"	10,000	10	11169
	.040/120					11170

* Trim length from bands

END BRUSHES - Crimped Round Silicon Carbide Filament - Mounted on 1/4" Stems



10154

Diameter	Filament Dia./Grit	Trim Length	Overall Length	Max. RPM	Standard Pack	Item Number
1/2"	.022/320	7/8"	2-9/16"	10,000	10	10172
	.035/180					10173
	.040/120					10174
3/4"	.022/320	7/8"	1-1/2"	10,000	10	10152
	.035/180					10153
	.040/120					10154
1"	.022/320	7/8"	2-3/4"	10,000	10	10155
	.035/180					10156
	.040/120					10157



26136

MINIATURE END BRUSHES - Plastic Ferrule - Crimped Round Silicon Carbide Filament Mounted on 1/8" stems

Diameter	Filament Dia./Grit	Trim Length	Overall Length	Max. RPM	Standard Pack	Item Number
3/16"	.018/500	1/4"	1-7/8"	37,000	144	26136
1/4"	.018/500	3/8"	2-1/8"	37,000	144	26138
5/16"	.018/500	9/16"	2-11/32"	25,000	144	26146

MINI DISC BRUSHES

MADE IN USA

Featuring a precision machined aluminum cup, Weiler's mini-disc brushes are designed to be the most cost-effective media for applications requiring a smaller brushing tool.

APPLICATIONS

- Deburring flat surfaces on machined components
- Improving texture characteristics on machined or ground surfaces
- Deburring face-milled castings or forgings
- Blending tool marks after machining or grinding



Deburring the machined face of an aluminum component.

BURR-RX® MINI DISC BRUSHES - Maximum Density - Crimped Black Ceramic Filament

Diameter	Filament Dia./Grit	Arbor Hole	Drive Arbor + Recommendation	Trim Length	Max. RPM	Standard Pack	Item Number
Round Filament							
2"	.026/120	3/8"	89029 or 89033	1-1/4"	4,500	2	86106
	.035/80						85738
	.043/120						86107
	.055/80						85733
3"	.026/120	3/8"	89029 or 89033	1-1/4"	4,500	1	86109
	.035/80						86013
	.043/120						86110
	.055/80						86111
Rectangular Filament							
2"	80	3/8"	89029 or 89033	1-1/4"	4,500	1	85736
3"	80	3/8"	89029 or 89033	1-1/4"	4,500	1	86014

+ See page 127 for drive arbor specifications.

MINI DISC BRUSHES - Silicon Carbide Filament

Diameter	Filament Dia./Grit	Arbor Hole	Drive Arbor + Recommendation	Trim Length	Max. RPM	Standard Pack	Item Number
Round Filament							
1-3/4"	.035/180 .022/120 .040/80	5/8"	89023 or 89024	1-1/4"	6,000	2	85753
							85751 •
							85750
Rectangular Filament							
1-3/4"	80	5/8"	89023 or 89024	1-1/4"	6,000	2	85752
2"	80	3/8"	89023 or 89024	1-1/4"	4,500	2	85773*
3"	80	3/8"	89023 or 89024	1-1/4"	4,500	1	85981*

+ See page 127 for drive arbor specifications. * Maximum density

• Non-stock product, contact Customer Service for lead times



85733



85752



85981

CUP BRUSHES

MADE IN USA

Weiler also offers an assortment of Nylox® tools featuring traditional cup brush construction for deburring and finishing use in lighter duty applications. These brushing tools can be used on dedicated machines in automated processes or on low speed/high torque hand-held tools for manual applications.

APPLICATIONS

- Deburring and finishing complex or contoured parts

CUP BRUSHES - Crimped Round Silicon Carbide Filament

Diameter	Filament Dia./Grit	Arbor Hole	Trim Length	Max. RPM	Standard Pack	Item Number
2-3/4"	.022/320 .035/180 .040/120	1/4" Stem	1-1/4"	6,000	1	14401 •
						14403 •
						14404
3-1/2"	.035/180 .040/120	5/8"-11	1-1/2"	12,000	1	14413
						14414
5"	.040/120	5/8"-11	1-1/4"	9,000	1	14576
6"	.040/120 .040/80	5/8"-11	1-1/4"	6,600	1	14516*
						14506*

* With internal nut

• Non-stock product, contact Customer Service for lead times



14413

NOTE
See adapters
on pages 126-127

COATED ABRASIVES

NON-WOVEN ABRASIVES

POWER BRUSHES

NYLOX BRUSHES

PACKAGED ITEMS

MAINTENANCE



Deburring internal bores of a cylinder head.

CUSTOMIZABLE CROSSHOLE DEBURRING SOLUTIONS

Replacement Bore-Rx Brush Heads and Reusable Bore-Rx Arbors

In high production applications, reusable arbors reduce manufacturing costs by allowing the use of inexpensive brush head replacements. Brush heads are made-to-order in diameters ranging from 7/8" to 1-1/2" with face widths of 1/4" to 1". They are available on 3/16" and 1/4" pins. The pin diameter is based on the application and determines brush density. Contact Application Engineering at 888-299-APPS (2777) for more information.



Replacement Head



Reusable Arbor 03993 •



Reusable Extension 03991 •

BORE-RX™ CROSSHOLE DEBURRING BRUSHES

MADE IN USA

These brushes are designed for automated applications in CNC machining centers and dedicated machines. They are ideal for removing burrs from internal edges and finishing bores. Since they eliminate off-hand deburring, they improve part-to-part consistency and reduce direct labor content. Bore-Rx brushes are available in sizes ranging from 7/8" to 4" and can be readily adapted into a machining center's tool changer using an end-mill holder or 3/8" collet.

Operating Parameters For Bore-Rx Brushes

Brush Diameter	Recommended RPM	Recommended Feed Rate
5/8" - 7/8"	3000	20"/min
1" - 1-1/2"	3000	20"/min
2" - 2-1/2"	2000	20"/min
3" - 4"	1500	20"/min

Tool Paths for Crosshole Deburring

An effective tool path for most crosshole deburring jobs is circular interpolation using the following guidelines to determine diameter of interpolation. The interpolation should be performed at a depth where the center of the brush face is at the center of the intersecting hole.

Diameter of Interpolation = Hole Dia. - 0.975 x Brush Dia.

Tool Paths for Bore Finishing

Nylox® brushes can be used to improve the surface finish of bores. The best tool path normally involves helically interpolating the bore. The above recommendations for speed, feed and diameter of interpolation are also valid for bore finishing. The use of coolant is highly recommended in order to achieve maximum surface finish improvement.



BORE-RX® BRUSHES - 3/8" Stem - Crimped Round Black Ceramic Filament

Diameter	Filament Dia./Grit	Face Width	Trim Length	Overall Length	Max. RPM	Standard Pack	Item Number
7/8"	.026"/120	3/4"	.160"	4-3/4"	8,000	1	17206
1"	.026"/120	3/4"	.215"	4-3/4"	8,000	1	17208
1-1/4"	.026"/120	3/4"	.345"	4-3/4"	8,000	1	17210
1-1/2"	.026"/120	1"	.475"	5"	8,000	1	17212
2"	.026"/120	1"	.535"	3-1/4"	6,000	1	17215
2-1/2"	.055"/80	1"	.765"	3-1/4"	6,000	1	17217
3"	.026"/120	1"	.560"	3-1/4"	6,000	1	86150
	86151						
	86152						
4"	.026"/120	1"	1.040"	3-1/4"	6,000	1	86154
	.043"/120						86155
	.055"/80						86156

Note: All Bore-Rx brush stems have a 2" long flat for use in end mill holders. Alternatively, they can be mounted in 3/8" collets.

TUBE BRUSHES

MADE IN USA

Nylox® power tube brushes are ideal for internal deburring and finishing applications in tubular component parts, drilled and tapered holes, and machined bores and passages. These brushes are suitable for use in drill presses and manual and CNC machine tools. See page 108 for operating guidelines.

TUBE BRUSHES - Micro Abrasive - For ultra-fine deburring and finishing of small internal holes.



26904



26908



26915

Diameter	Length of Brush Part	Stem Diameter	For Hole Diameters		Overall Length	Standard Pack	Item Number
			Decimal	Fraction			
2000 Grit Aluminum Oxide Filament							
.030"	1/2"	.015	.031"	1/32"	4"	10	26900
.050"	1/2"	.022	.047"	3/64"	4"		26901
.075"	3/4"	.033	.063"	1/16"	4"		26902
.090"	3/4"	.041	.078"	5/64"	4"		26903
.105"	1"	.041	.094"	3/32"	4"		26904
.125"	1"	.064	.109"	7/64"	4"		26905
.135"	1"	.075	.125"	1/8"	4"		26906
600 Grit Aluminum Oxide Filament							
.165"	1"	.087	.156"	5/32"	5"	10	26907
.190"	1"	.087	.188"	3/16"	5"		26908
.260"	1"	.115	.250"	1/4"	5"		26909
.325"	1"	.115	.313"	5/16"	5"		26910
.385"	1"	.147	.375"	3/8"	5"		26911
.515"	1"	.194	.500"	1/2"	5"		26912
.640"	1"	.194	.625"	5/8"	5"		26913 •
.765"	1"	.212	.750"	3/4"	5"		26914 •
.890"	1"	.212	.875"	7/8"	5"		26915 •

• Non-stock product, contact Customer Service for lead times

NEW NOW OFFERING MORE SIZE OPTIONS

BURR-RX® TUBE BRUSHES - Crimped Black Ceramic Filament - 1/4" Cadmium Plated Stems

Nominal Diameter	Traditional Diameter	Metric Diameter	Filament Dia./Grit	Length of Brush Part	Stem Diameter	Overall Length	Standard Pack	Item Number
6mm	0.236"	6.00 mm	.026/120	1"	1/4"	3-1/2"	10	22602
1/4"	0.250"	6.35 mm	.026/120	1"	1/4"	3-1/2"	10	21757 •
7mm	0.276"	7.00 mm	.026/120	1"	1/4"	3-1/2"	10	22603
8mm	0.315"	8.00 mm	.026/120	1"	1/4"	3-1/2"	10	22604
9mm	0.354"	9.00 mm	.026/120	1"	1/4"	3-1/2"	10	22605
3/8"	0.375"	9.53 mm	.026/120	1"	1/4"	3-1/2"	10	21758
10mm	0.394"	10.00 mm	.026/120	1"	1/4"	3-1/2"	10	22606
11mm	0.433"	11.00 mm	.026/120	1"	1/4"	3-1/2"	10	22607
12mm	0.472"	12.00 mm	.026/120	1"	1/4"	3-1/2"	10	22608
1/2"	0.500"	12.70 mm	.026/120	1"	1/4"	3-1/2"	10	21759
14mm	0.551"	14.00 mm	.026/120	1"	1/4"	3-1/2"	10	22610
9/16"	0.563"	14.29 mm	.026/120	1"	1/4"	3-1/2"	10	21760 •
5/8"	0.625"	15.88 mm	.026/120	1"	1/4"	3-1/2"	10	21761
18mm	0.709"	18.00 mm	.026/120	1"	1/4"	3-1/2"	10	22614
3/4"	0.750"	19.05 mm	.026/120	1"	1/4"	3-1/2"	10	21762
20mm	0.787"	20.00 mm	.026/120	1"	1/4"	3-1/2"	10	22616
7/8"	0.875"	22.23 mm	.026/120	1"	1/4"	3-1/2"	10	21763
1"	1.000"	25.40 mm	.026/120	1"	1/4"	3-1/2"	10	21764
1-1/4"	1.250"	31.75 mm	.026/120	1"	1/4"	3-1/2"	10	21765 •

• Non-stock product, contact Customer Service for lead times



Crosshole deburring an aluminum manifold.



TUBE BRUSHES - Crimped Round Silicon Carbide Filament - Double Stem, Single Spiral

Diameter	Filament Dia./Grit	Length of Brush Part	Stem Diameter	Overall Length	Standard Pack	Item Number
1/4"	.022/320	2"	5/32"	5"	10	21126
3/8"	.022/320	2"	5/32"	5"	10	21128
1/2"	.022/320 .040/80	2"	3/16"	5"	10	21130 21325
5/8"	.022/320 .040/80	2"	7/32"	5"	10	21132 21326
11/16"	.022/320	2"	7/32"	5"	10	21133
3/4"	.022/320 .040/80	2-1/2"	1/4"	5-1/2"	10	21134 21327
7/8"	.022/320 .040/80	2-1/2"	1/4"	5-1/2"	10	21136 21976
1"	.022/320 .040/80	2-1/2"	1/4"	5-1/2"	10	21138 21328
1-1/4"	.022/320 .022/120 .035/180 .040/80	2-1/2"	1/4"	5-1/2"	10	21306 21304 21305 21329
1-1/2"	.022/320 .035/180 .040/80	2-1/2"	1/4"	5-1/2"	10	21309 21308 21330
1-3/4"	.040/80 .035/180	2-1/2"	1/4"	5-1/2"	10	21311 21312
2"	.022/320 .040/80	2-1/2"	1/4"	5-1/2"	10	21473 21345



COATED ABRASIVES

NON-WOVEN ABRASIVES

POWER BRUSHES

NYLON BRUSHES

PACKAGED ITEMS

MAINTENANCE

FLAT SURFACE DEBURRING PRODUCTS

MADE IN
USA

DISC BRUSHES

Manufactured using a tufted filament configuration and longer trim length for increased aggression, greater conformability and longer product life in comparison to monofilament disc brushes, which feature a distribution of short individual bristles.

Burr-Rx® disc brushes feature Weiler's advanced black ceramic grain filament, which delivers up to a 400% greater edge cutting action in comparison to traditional silicon carbide and aluminum oxide filaments for the fastest, most aggressive deburring action for minimum cycle times and maximum life.

All Burr-Rx disc brushes are manufactured using a new process that results in a very consistent, flat brush face in comparison to traditional construction, which utilizes a molded backing. The high dimensional precision of these tools means that the brushes are suitable for the most critical applications and perform more consistently from first part to last. In addition, the machined polymer backings are designed to mount directly onto a standard shell mill holder for convenient use in CNC machining centers.

APPLICATIONS

- Deburring flat surfaces on machined components
- Deburring face-milled castings or forgings
- Improving texture characteristics on machined or ground surfaces
- Blending tool marks after machining or grinding

DISC BRUSHES

0.075" - 0.100" DEPTH OF INTERFERENCE

OPERATING SPEEDS - DISC BRUSHES



Diameter	RPM
1-3/4" & 2"	1,750 - 2,000
3"-4"	1,500 - 1,750
5" - 6"	1,250 - 1,500
8"	800 - 1,000
10"	700 - 800
12"	600 - 700
14"	500 - 600

FEED RATE RECOMMENDATIONS

Feed rate is determined by the amount of deburring, edge radiusing or surface finishing required, and the type of material that is being processed. It is generally application specific. Slower feeds result in a more aggressive brushing action. Based on the brushing action desired for a specific application, the feed rate can be increased or decreased.

Material	SiC and AO Grain Feed Rate	Burr-Rx Grain Feed Rate
Non-Ferrous	50 in./min.	80 in./min.
Cast Iron	30 in./min.	60 in./min.
Mild Steel and Ductile Iron	25 in./min.	50 in./min.
Stainless and Alloy Steels	15 in./min.	30 in./min.
Titanium and High Nickel Alloys	10 in./min.	30 in./min.

BURR-RX® SHELL MILL HOLDER DISC BRUSHES - Crimped Black Ceramic Filament

Compatible with 3" shell mill holders.

Diameter	Filament Dia./Grit	Arbor Hole	Trim Length	Max. RPM	Standard Pack	Item Number
Round Filament						
4"	.026/120	1-1/4"	1-1/2"	2,500	1	86112
	.043/120					86113
	.043/120					86204* •
	.055/80					86114*
6"	.026/120	1-1/4"	1-1/2"	2,500	1	86115
	.043/120					86116
	.055/80					86117*
	8"					.026/120
.043/120		86142				
.055/80		86143*				
10"		.026/120	1-1/4"	1-1/2"	2,000	1
	.043/120	86121				
	.055/80	86122*				
	Rectangular Filament					
4"	80	1-1/4"	1-1/2"	2,500	1	86167*
6"	80	1-1/4"	1-1/2"	2,500	1	86198*
8"	80	1-1/4"	1-1/2"	2,500	1	86199* •

* Maximum Density

• Non-stock product, contact Customer Service for lead times



Deburring a bearing cage in a CNC machining center.



Disc brush shown with shell mill holder



86112



86143

COMPOSITE HUB DISC BRUSHES - Silicon Carbide Filament

Diameter	Filament Dia./Grit	Arbor Hole	Drive Arbor Recommendation	Trim Length	Max. RPM	Standard Pack	Item Number
Crimped Round Filament							
3"	.035/180	7/8"	07700	1-1/2"	2,500	1	85776
	.040/120						85778
3-1/2"	.022/320	7/8"	07700	1-1/2"	2,500	1	85792
	.035/180						85794
	.040/80						85798
4"	.022/320	7/8"	07700	1-1/2"	2,500	1	85812
	.035/180						85814
	.040/120						85816
	.040/80						85818
5"	.035/180	7/8"	07700	1-1/2"	2,500	1	85832
	.040/80						85836 •
6"	.035/180	7/8"	07701	1-1/2"	2,000	1	85850
	.040/120						85852
	.040/80						85854
8"	.035/180	7/8"	07702	1-1/2"	2,000	1	85908
	.040/120						85912 •
	.040/80						85914 •
10"	.040/120	7/8"	07703	1-1/2"	1,750	1	85930
	.040/80						85932 •
12"	.035/180	7/8"	07703	1-1/2"	1,750	1	85946 •
	.040/120						85948 •
Rectangular Filament							
3"	120	7/8"	07700	1-1/2"	2,500	1	85786
	80						85788
3-1/2"	320	7/8"	07700	1-1/2"	2,500	1	85800 •
	80						85806
4"	180	7/8"	07700	1-1/2"	2,500	1	85822 •
	120						85824
	80						85826
	80						85995 •
	80						85900* •
5"	120	7/8"	07700	1-1/2"	2,500	1	85842 •
	80						85844
	80						85978 •
6"	120	7/8"	07701	1-1/2"	2,000	1	85860
	80						85862
	80						85996 •
	80						85901* •
	80						85922
8"	120	7/8"	07702	1-1/2"	2,000	1	85920 •
	80						85922
9"	80	7/8"	07702	1-1/2"	1,750	1	85997 •
10"	120	7/8"	07703	1-1/2"	1,750	1	85938 •
	80						85940 •

* Banded for extra aggression

• Maximum density

• Non-stock product, contact Customer Service for lead times



Deburring the edges of an aluminum engine cover.



85852



85786

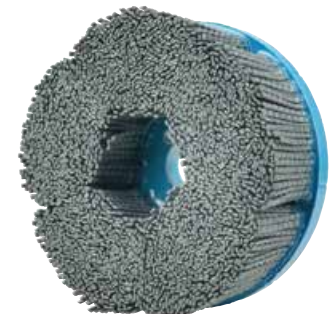

85978

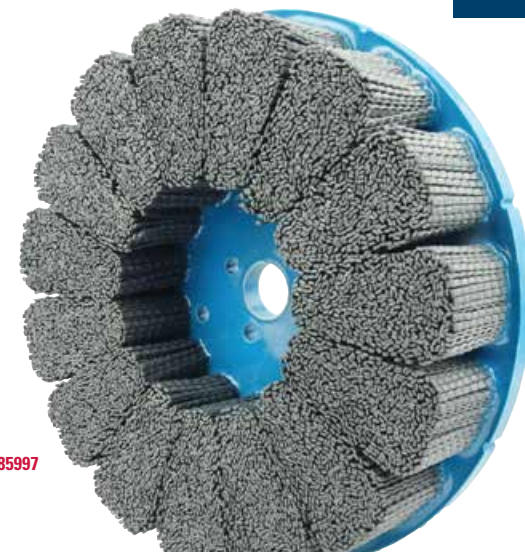

85997

COATED ABRASIVES

NON-WOVEN ABRASIVES

POWER BRUSHES

NYLON BRUSHES

Arbor & Drive Hole Specifications for Composite Hub Disc Brushes

Brush Diameter	Arbor Hole Diameter	Drive Holes
3"-5", 6" Max. Density	7/8"	(2) 1/4" dia. on a 1-1/4" dia. bolt circle
6"	7/8"	(3) 1/4" dia. on a 3" dia. bolt circle
8"	7/8"	(4) 1/4" dia. on a 3" dia. bolt circle
10"	7/8"	(4) 1/4" dia. on a 1.625" dia. bolt circle
12"	7/8"	(4) 1/4" dia. on a 1.625" dia. bolt circle

NOTE

See adapters on pages 126-127



Removing burrs and breaking sharp edges on a transmission component.

MINI DISC BRUSHES

MADE IN USA

Featuring a precision machined aluminum cup, Weiler's mini-disc brushes are designed to be the most cost-effective media for applications requiring a smaller brushing tool.

APPLICATIONS

- Deburring flat surfaces on machined components
- Improving texture characteristics on machined or ground surfaces
- Deburring face-milled castings or forgings
- Blending tool marks after machining or grinding

BURR-RX® MINI DISC BRUSHES - Maximum Density - Crimped Black Ceramic Filament

Diameter	Filament Dia./Grit	Arbor Hole	Drive Arbor + Recommendation	Trim Length	Max. RPM	Standard Pack	Item Number
Round Filament							
2"	.026/120	3/8"	89029 or 89033	1-1/4"	4,500	2	86106
	.035/80					1	85738
	.043/120					2	86107
	.055/80					2	85733
3"	.026/120	3/8"	89029 or 89033	1-1/4"	4,500	1	86109
	.035/80						86013
	.043/120						86110
	.055/80						86111
Rectangular Filament							
2"	80	3/8"	89029 or 89033	1-1/4"	4,500	1	85736
3"	80	3/8"	89029 or 89033	1-1/4"	4,500	1	86014



85733



85752



85981

+ See page 127 for drive arbor specifications.

MINI DISC BRUSHES - Silicon Carbide Filament

Diameter	Filament Dia./Grit	Arbor Hole	Drive Arbor + Recommendation	Trim Length	Max. RPM	Standard Pack	Item Number
Round Filament							
1-3/4"	.035/180	5/8"	89023 or 89024	1-1/4"	6,000	2	85753
	.022/120						85751 •
	.040/80						85750
Rectangular Filament							
1-3/4"	80	5/8"	89023 or 89024	1-1/4"	6,000	2	85752
2"	80	3/8"	89023 or 89024	1-1/4"	4,500	2	85773*
3"	80	3/8"	89023 or 89024	1-1/4"	4,500	1	85981*

+ See page 127 for drive arbor specifications. * Maximum density

• Non-stock product, contact Customer Service for lead times



"I have had no issues with any Weiler products. They are reliable. They make a good product. I don't think you could ask for anything else."

- **Richard Carpenter**, Nuclear Industry Worker

END BRUSHES

MADE IN USA

Featuring an integral stem for convenient mounting into a tool holder or collet, Nylox® end brushes and miniature end brushes are suitable for addressing recesses and internal features, or delivering a targeted brushing action to a specific area on a part.

APPLICATIONS

- Deburring small recessed areas and internal part features
- Finishing slots and recessed surfaces on machined parts



Blending tool marks on a hydraulic component.

BURR-RX® END BRUSHES - Banded - Crimped Round Black Ceramic Filament - Mounted on 1/4" Stems

Diameter	Filament Dia./Grit	Trim Length*	Recommended RPM	Overall Length	Max. RPM	Standard Pack	Item Number
3/8"	.026/120	1/4"	4,500 - 5,000	2-3/8"	10,000	10	86098
	.043/120						86099
1/2"	.026/120	1/4"	4,500 - 5,000	2-7/16"	10,000	10	86100
	.043/120						86101
3/4"	.026/120	1/4"	4,200 - 4,500	2-7/16"	10,000	10	86102
	.043/120						86103
1"	.026/120	1/4"	3,500 - 3,800	2-5/8"	10,000	10	86104
	.043/120						86105
	.055/80						86097

* Trim length from bands



86104

END BRUSHES - Banded - Crimped Round Silicon Carbide Filament - Mounted on 1/4" Stems

Diameter	Filament Dia./Grit	Trim Length*	Overall Length	Max. RPM	Standard Pack	Item Number
1/2"	.022/320	3/8"	2-9/16"	10,000	10	11160
	.035/180					11161
	.040/120					11162
3/4"	.035/180	3/8"	2-7/16"	10,000	10	11165
	.040/120					11166
1"	.035/180	3/8"	2-11/16"	10,000	10	11169
	.040/120					11170

* Trim length from bands



11166

END BRUSHES - Crimped Round Silicon Carbide Filament - Mounted on 1/4" Stems

Diameter	Filament Dia./Grit	Trim Length	Overall Length	Max. RPM	Standard Pack	Item Number
1/2"	.022/320	7/8"	2-9/16"	10,000	10	10172
	.035/180					10173
	.040/120					10174
3/4"	.022/320	7/8"	1-1/2"	10,000	10	10152
	.035/180					10153
	.040/120					10154
1"	.022/320	7/8"	2-3/4"	10,000	10	10155
	.035/180					10156
	.040/120					10157



10154

MINIATURE END BRUSHES - Plastic Ferrule - Crimped Round Silicon Carbide Filament

Mounted on 1/8" stems

Diameter	Filament Dia./Grit	Trim Length	Overall Length	Max. RPM	Standard Pack	Item Number
3/16"	.018/500	1/4"	1-7/8"	37,000	144	26136
1/4"	.018/500	3/8"	2-1/8"	37,000	144	26138
5/16"	.018/500	9/16"	2-11/32"	25,000	144	26146



26136

COATED ABRASIVES

NON-WOVEN ABRASIVES

POWER BRUSHES

NYLOX BRUSHES

PACKAGED ITEMS

MAINTENANCE

TARGETED FEATURE DEBURRING PRODUCTS

MADE IN
USA

WHEEL BRUSHES



Deburring a vane section for a jet engine.

Weiler's Nylox® abrasive nylon wheel brushes featuring composite metal hub and composite hub construction are manufactured using a molded polymer material to retain the filaments. In comparison to traditional metal hub construction that folds the fill material around an internal retaining ring or wrap wire, these techniques result in a significant increase in fill density and elimination of filament breakage, offering the lowest cost-of-use and greatest consistency of performance in production applications.

Weiler's composite metal hub wheels marry the high density and superior filament retention of composite hub wheels with the dimensional stability and shock resistance of metal hub construction, and they feature 2" arbor holes, which allows for convenient mounting on many pieces of equipment.

Burr-Rx® wheels feature Weiler's advanced black ceramic grain filament, which delivers up to a 400% greater edge cutting action in comparison to traditional silicon carbide and aluminum oxide filaments for the fastest, most aggressive deburring action to minimize cycle times and maximize media life.

APPLICATIONS

- Precision deburring of component parts after machining or grinding
- Improving texture characteristics on machined or ground surfaces
- Honing cutting tools and generating specific edge profiles and radii
- Light duty cleaning and finishing of metals; light sanding of woods and composites

BURR-RX® CRIMPED FILAMENT WHEELS

Composite Metal Hub* - Crimped Round Black Ceramic Filament

Diameter	Filament Dia./Grit	Arbor Hole	Face Width	Trim Length	Thickness At Face Plates	Max. RPM	Standard Pack	Item Number
6"	.026/120	2"	3/4"	1"	15/16"	4,000	1	86123
	.035/80							86181
	.043/120							86124
	.055/80							86120
8"	.026/120	2"	7/8"	2"	15/16"	4,000	1	86126
	.043/120							86127
	.055/80							86128
10"	.026/120	2"★	1-1/8"	2"	7/8"	1,800	2	86129
	.035/80							86182 •
	.043/120							86130
	.055/80							86131
12"	.026/120	2"★	1-1/4"	3"	7/8"	1,800	2	86132
	.043/120							86133
	.055/80							86134
	.026/120							2"★
.035/80	86108							
.043/120	86136							
.055/80	86137							
14"	.026/120	2"★	1-1/4"	4"	7/8"	1,800	2	86138 •
	.043/120							86139
	.055/80							86140

* Patent Pending

★ 1/2" x 1/4" Double Keyway

• Non-stock product, contact Customer Service for lead times

BURR-RX CRIMPED FILAMENT WHEELS

Composite Hub - Crimped Round Black Ceramic Filament

O.D. x I.D.	Filament Dia./Grit	Face Width	Trim Length	Thickness At Face Plates	Max. RPM	Standard Pack	Item Number
8" x 3-1/4"	.043/120	1"	1-5/16"	13/16"	1,800	2	83394 •
14" x 7-1/4"	.026/120	1"	2-3/4"	15/16"	1,800	2	84926 •
	.043/120						84941 •
	.035/80						84925 •
	.055/80						83405

• Non-stock product, contact Customer Service for lead times



CRIMPED FILAMENT WHEELS - Composite Metal Hub* - Crimped Round Silicon Carbide Filament

Diameter	Filament Dia./Grit	Arbor Hole	Face Width	Trim Length	Thickness Through Arbor	Max. RPM	Standard Pack	Item Number
6"	.018/500	2"	1"	1-1/4"	1-1/16"	4,000	1	83000
	.022/320							83010
	.022/120							83011
	.035/180							83030
	.040/120							83040
	.040/80							83050
	.060/46							83070 •
8"	.018/500	2"	1"	2-1/4"	3/4"	4,000	2	83100
	.022/320							83110
	.022/120							83111
	.035/180							83130
	.040/120							83140
	.040/80							83150
								83156 •
10"	.022/320	2"★	1-1/8"	2"	7/8"	1,800	2	83513 •
	.035/180							83514 •
	.040/120							83515 •
	.040/80							83516 •
								83518 •
12"	.022/320	2"★	1-1/4"	3"	7/8"	1,800	2	83715 •
	.035/180							83716 •
	.040/120							83717
	.040/80							83718
								83718

*Patent Pending

★ 1/2" x 1/4" Double Keyway

• Non-stock product, contact Customer Service for lead times

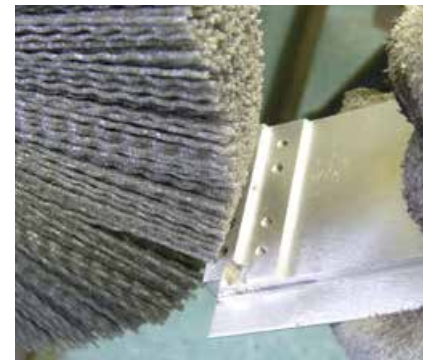

Removing burrs from an aluminum heat sink.

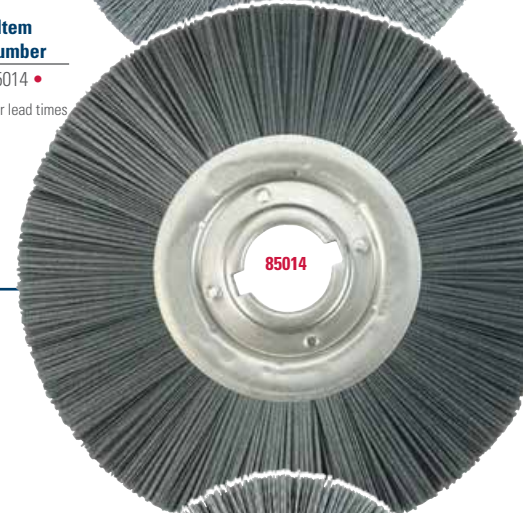

COATED ABRASIVES

RECTANGULAR FILAMENT WHEEL - Composite Metal Hub* - Straight Silicon Carbide Filament

Diameter	Grit Size	Arbor Hole	Face Width	Trim Length	Thickness Through Arbor	Max. RPM	Standard Pack	Item Number
12"	80	2"★	1-1/4"	3"	7/8"	1,800	2	85014 •

*Patent Pending

★ 1/2" x 1/4" Double Keyway

• Non-stock product, contact Customer Service for lead times

METAL HUB BASIC SECTIONS

MADE IN USA

CRIMPED FILAMENT BASIC SECTIONS - Metal Hub - Crimped Round Silicon Carbide Filament

For light-duty deburring and finishing in applications such as low-volume manual deburring or general use in a tool room or shop.

O.D. x I.D.	Filament Dia./Grit	Face Width	Trim Length	Thickness Through Arbor	Max. RPM	Standard Pack	Item Number
6" x 2"	.022/320	5/8"	1-1/2"	9/16"	6,000	2	20600
	.035/180						20610
	.040/120						20620
8" x 2"	.022/320	5/8"	2-1/2"	9/16"	5,000	2	20630 •
	.040/120						20650
							20661 •
10" x 3-1/4"	.035/180	9/16"	2-7/8"	17/32"	4,500	2	20661 •
14" x 5-1/4"	.035/180	9/16"	3-7/8"	9/16"	3,000	2	20730 •

• Non-stock product, contact Customer Service for lead times

NOTE
See adapters
on pages 126-127



Deburring the tip of a turbine blade.

NARROW FACE WHEELS



BURR-RX® HEAVY-DUTY NARROW FACE WHEELS - Metal Hub - Crimped Round Black Ceramic Filament

Diameter	Filament Dia./Grit	Arbor Hole	Face Width	Trim Length	Thickness Through Arbor	Max. RPM	Standard Pack	Item Number
3"	.026/120	5/8"-1/2"	9/16"	1/2"	7/16"	6,000	2	31240
	.035/80							31241
4"	.026/120	5/8"-1/2"	5/8"	1"	7/16"	6,000	2	31110
	.035/80							31270
	.043/120							31280
	.055/80							31290



31110



86165

BURR-RX NARROW FACE WHEELS - Metal Hub - Crimped Round Black Ceramic Filament

Diameter	Filament Dia./Grit	Arbor Hole	Face Width	Trim Length	Thickness Through Arbor	Max. RPM	Standard Pack	Item Number
3"	.035/80	1/2"-3/8"	3/8"	1/2"	7/16"	6,000	2	31102
	.043/120							31101
4"	.026/120	1/2"-3/8"	1/2"	7/8"	7/16"	6,000	2	86165
	.035/80							31103
	.043/120							31100
	.055/80							31105
6"	.026/120	5/8"-1/2"	5/8"	7/8"	11/16"	4,500	2	31134
	.043/120							31135
	.035/80							31136
	.055/80							31137

HEAVY-DUTY NARROW FACE WHEELS - Metal Hub - Crimped Round Silicon Carbide Filament

Diameter	Filament Dia./Grit	Arbor Hole	Face Width	Trim Length	Thickness Through Arbor	Max. RPM	Standard Pack	Item Number
3"	.040/80	5/8"-1/2"	9/16"	1/2"	7/16"	6,000	2	31245 •
4"	.022/320	5/8"-1/2"	5/8"	1"	7/16"	6,000	2	31255 •
	.035/180							31265
	.040/120							31275
	.040/80							31285

• Non-stock product, contact Customer Service for lead times



31285

NARROW FACE WHEELS - Metal Hub - Crimped Round Silicon Carbide Filament

Diameter	Filament Dia./Grit	Arbor Hole	Face Width	Trim Length	Thickness Through Arbor	Max. RPM	Standard Pack	Item Number
3"	.022/320	1/2"-3/8"	3/8"	1/2"	7/16"	6,000	2	31074
	.035/180							31084
	.040/120							31094
4"	.022/320	1/2"-3/8"	1/2"	7/8"	7/16"	6,000	2	31104
	.035/180							31114
	.040/120							31124
6"	.022/320	5/8"-1/2"	5/8"	7/8"	11/16"	4,500	1	31121
	.035/180							31122
	.040/120							31123



31124

APPLICATION ENGINEERED WHEELS

CRIMPED FILAMENT WHEELS - Composite Hub - Crimped Round Silicon Carbide Filament

O.D. x I.D.	Filament Dia./Grit	Face Width	Trim Length	Thickness Through Arbor	Max. RPM	Standard Pack	Item Number
6" x 2"	.040/80	1/2"	1-1/4"	9/16"	3,600	1	83116 •
8" x 2"*	.040/120	7/8"	2-1/8"	13/16"	3,600	2	83190 • 83180 •
8" x 3-1/4"	.040/80	1"	1-5/16"	13/16"	1,800	2	83393 •
10" x 2"	.018/500 .022/320 .035/180 .040/120 .040/80	1"	3"	1-1/16"	3,600	2	83300 83310 • 83330 83340 83350
10" x 3-1/4"	.035/180 .040/120 .040/80	1"	2-5/16"	13/16"	1,800	2	83430 • 83440 83450
10" x 5-1/4"	.040/80	1"	1-5/8"	15/16"	1,800	2	83550
12" x 3-1/4"	.035/180 .040/120	1-1/8"	3-5/16"	13/16"	1,800	2	83630 • 83640 •
12" x 4-1/4"	.022/320 .035/180 .040/120 .040/80	1"	3-1/8"	15/16"	1,800	2	84710 • 84730 • 84740 • 84750 •
12" x 5-1/4"	.040/120 .040/80	1-1/8"	2-3/4"	15/16"	1,800	2	83740 • 83750
12" x 5-1/4"-2"*	.022/320	1-1/8"	2-3/4"	1-1/16"	1,800	2	85156 ••
14" x 5-1/4"	.022/320 .035/180 .040/120 .040/80	1-1/8"	3-3/4"	15/16"	1,800	2	83910 83930 83940 83950
14" x 5-1/4"-2"*	.022/320 .040/80	1-1/8"	3-3/4"	1-1/16"	1,800	2	85150 •• 85153 ••
20" x 12"	.035/180	1-1/4"	3-1/4"	1-1/16"	1,000	1	85440 •

- Same density as our standard 5-1/4" I.D. brushes, but requires no adapters for mounting on a 2" diameter shaft.
- Non-stock product, contact Customer Service for lead times
- Non-stock product, contact Customer Service for lead-time.
- * 1/2" x 1/4" Double Keyway



Deburring a camshaft with a Nylox wheel.



RECTANGULAR FILAMENT WHEEL - Composite Hub - Straight Silicon Carbide Filament

O.D. x I.D.	Grit Size	Face Width	Trim Length	Thickness Through Arbor	Max. RPM	Standard Pack	Item Number
14" x 5-1/4"	120	1-1/8"	3-3/4"	1-1/16"	1,800	2	84640

Other diameters and grit sizes available upon request.

DIAMOND FILAMENT WHEEL BRUSHES

MADE IN
USA

Weiler's diamond filament wheels are ideal for producing edge radii on hard materials such as diamond, CBN, ceramic and glass. Our wheel brushes are made-to-order in a wide range of diameters and thicknesses. Additional configurations are available such as; tube brushes, composite hub disc brushes and end brushes. Other sizes and pricing are available on request. Please contact Customer Service at 800-835-9999.

DIAMOND FILAMENT WHEELS - Composite Hub - Round Diamond Filament

O.D. x I.D.	Filament Dia./Grit	Face Width	Trim Length	Thickness Through Arbor	Max. RPM	Standard Pack	Item Number
6" x 2"	.024/200 .014/600 .012/1000	5/16"	1-1/4"	1/4"	3,600	1	83002 • 83003 • 83004 •
8" x 2"	.024/200 .014/600 .012/1000	5/16"	2-1/4"	1/4"	3,600	1	83005 • 83006 • 83007 •

- Non-stock product, contact Customer Service for lead-times.

NOTE
See adapters
on pages 126-127

ADAPTERS AND DRIVE ARBORS



03809



03923

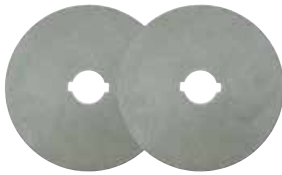

03944



03403

NOTE

The adapters and drive arbors listed on this page are for use with small diameter wheel brushes only; do not attempt to use them with cutting or grinding wheels, buffing wheels, or any type of abrasive wheel or disc.

METAL ADAPTERS - Reusable - Used in pairs and priced per pair.

Diameter	Arbor Hole Size	Used With	Standard Pack	Item Number
2"	1/2"	All 2" I.D. Wheels	1	03809
	5/8"			03810
	3/4"			03811
	7/8"			03824
	1"			03812
	1-1/4"			03813
	1-1/2"			03814
3-1/4"	3/4"	3-1/4" I.D. Wheels (When mounting only one wheel)	1	03910 •
	7/8"			03911 •
	1"			03912 •
	1-1/4"			03913 •
	2"			03915 •
5-1/4"	3/4"	5-1/4" I.D. Wheels (When mounting only one wheel)	1	03920 •
	7/8"			03921 •
	1"			03922 •
	1-1/4"			03923 •
	2"			03925 •

• Non-stock product, contact Customer Service for lead-times.

STEEL FLANGES - Reusable - Used on the ends of a gang mount. Used in pairs and priced per pair. Must be used in conjunction with Pressboard Adapters in chart below.

Flange O.D.	Arbor Hole Size	Used With	Standard Pack	Item Number
5-5/8"	3/4"	3-1/4" & 4-1/4" I.D. Wheels	1	03931 •
	1"			03933 •
	1-1/4"			03934 •
	2"			03936 •
6-1/2"	1-1/4"	5-1/4" I.D. Wheels	1	03944 •
	1-1/2"			03945 •
	2"			03946 •
8-3/4"	1-1/4"	7-1/4" I.D. Wheels	1	03954 •
	1-1/2"			03955 •
	2"			03956 •

• Non-stock product, contact Customer Service for lead-times.

PRESSBOARD ADAPTERS - Used for centering 10", 12" and 14" Nylox® Wheels when gang mounting. Must be used in conjunction with Steel Flanges in chart above.

Brush I.D.	Arbor Hole Size	Standard Pack	Item Number
3-1/4"	3/4"	1	03890 •
	1"		03892 •
	1-1/4"		03893 •
	2"		03895 •
	4-1/4"		03960 •
4-1/4"	3/4"	1	03963 •
	1-1/4"		03965 •
	2"		03403 •
	1-1/2"		03404 •
5-1/4"	1-1/4"	1	03405 •
	1-1/2"		03973 •
	2"		03974 •
7-1/4"	1-1/4"	1	03975 •
	1-1/2"		03976 •
	2"		03977 •

• Non-stock product, contact Customer Service for lead-times.



83999

Lubricut™ Lubricant

**Prevents Smearing.
Improves the Finish.
Lowers Costs.**



1. Turn off machine.



2. Slowly rotate wheel by hand.



3. While rotating, direct a light spray of Lubricut into the wheel face.

Use with Nylox® wheels operating above the recommended surface speed. Directing a light spray of Lubricut into the face of the wheel permits the wheel to be operated at higher surface speeds and up to twice the normal load without smearing - while improving the finish.

Description	Ounces	Standard Pack	Item Number
Lubricut Lubricant	8	1	83999

PLASTIC ADAPTERS

Fixed Arbor Hole Size	Adapted Arbor Hole Size	Used With	Standard Pack	Item Number
1/2"	1/4"	Small Dia. Wheels	10	04400
1/2"	3/8"	Small Dia. Wheels	10	04401
5/8"	1/2"	Small Dia. Wheels	10	04402



04401

04402

MINIATURE & BURR-RX® DISC BRUSH DRIVE ARBORS - Includes drive arbor, set screw and hex key.

For Brush Diameter	Stem Diameter	Stem Length	Max. RPM	Standard Pack	Item Number
1-3/4"	1/4"	1-3/4"	6,000	1	89023*
1-3/4"	3/8"	1-3/4"	6,000	1	89024*
2"-3"	1/2"	1-3/4"	6,000	1	89029*

* For use with Burr-Rx Mini Disc brushes on page 111 & 116 only. Products supplied with set screw and wrench.



89023

MINIATURE & BURR-RX DISC BRUSH DRIVE ARBORS - Includes drive arbor, set screw and hex key. Recommended for operations in which brush rotation alternates between forward and reverse.

For Brush Diameter	Stem Diameter	Stem Length	Max. RPM	Standard Pack	Item Number
2"-3"	1/2"	1-3/4"	6,000	1	89033*

* For use with Burr-Rx Mini Disc brushes on page 111 & 116 only. Products supplied with set screw and wrench.



89033

DISC BRUSH FLOW-THROUGH DRIVE ARBORS

Mounts Weiler disc brushes to any type of milling machine or CNC machine.

Fits	Arbor Hole	Drive Studs	Bolt Circle	Plate O.D.	Shaft Dia.	Stem Length	Std. Pack	Item Number
3", 4" and 5" Disc Brushes	7/8"	2	1-1/4"	2-7/8"	3/4"	2-3/4"	1	07700
6" Std. Tuft Disc Brushes NOT Max. Density	7/8"	3	3"	5-7/8"	3/4"	2-1/2"	1	07701
6" Max. Density Disc Brushes, also 5" Std. Tuft	7/8"	2	1-1/4"	4-7/8"	3/4"	2-1/2"	1	07715
8" and 9" Disc Brushes	7/8"	4	3"	7-7/8"	3/4"	2-1/2"	1	07702
10" and 12" Disc Brushes	7/8"	4	1-5/8"	9-7/8"	3/4"	2-1/2"	1	07703 •

Replacement kit includes: (1) 1/2"-13 locking flow-through bolt & (1) Belleville spring washer

• Non-stock product, contact Customer Service for lead-times.



07700



07718

NOTE

- Do not adapt a wheel brush for use on a shaft diameter less than that specified by ANSI B165.1 (see page 55) or exceed the maximum wheel diameter specified for a drive arbor.
- Never mount a drive arbor onto a tool that operates above the maximum RPM rating of either the arbor or the brush (whichever may be lower) and be sure that the stem of the arbor is properly secured in the collet or chuck before use.

WHY WEILER

BONDED ABRASIVES

COATED ABRASIVES

NON-WOVEN ABRASIVES

POWER BRUSHES

NYLON BRUSHES

PACKAGED ITEMS

MAINTENANCE

FME AREA PRODUCT SOLUTIONS



Removing gasket material from a pipe flange.

In nuclear power plants, Foreign Material Exclusion (FME) programs may limit or even exclude the use of wire brushes in some areas during the performance of routine maintenance, repair or shut-down activities. Weiler has developed a FME-compliant tooling system to address the needs of plant operators and maintenance contractors working in these facilities as well as other industries where the potential introduction of broken wire filaments may be of concern. Weiler's FME Solutions program is a complete system consisting of non-wire brushing tools designed to perform a broad range of surface cleaning and preparation applications.

BLACK NYLOX® CERAMIC BRUSHES - The engineered ceramic grain in Weiler's Black Nylox filament is up to 400% more aggressive than the silicon carbide and aluminum oxide grain in other abrasive filaments, making it much more effective in surface cleaning applications. The efficient cutting action of the Black Nylox filament also generates less heat and makes it much more resistant to "smearing" than traditional nylon abrasive filaments.



31112

NARROW FACE WHEELS - Crimped Ceramic Filament
Used on edge for weld prep and cold weld cleaning.

Diameter	Filament Dia./Grit	Face Width	Arbor Hole	Max. RPM	Standard Pack	Item Number
4"	.055/80	1/2"	5/8"-11 Nut	4,800	5	31112 •
4"	.043/120	1/2"	5/8"-11 Nut	4,800	5	31111 •

• Non-stock product, contact Customer Service for lead-times.



86160

CUP BRUSH - Rectangular Ceramic Filament
Used on its face for heavy-duty cleaning of broad surfaces.

Diameter	Filament Dia./Grit	Arbor Hole	Max. RPM	Standard Pack	Item Number
4"	.049 x .098 - 80 Grit	5/8"-11 Nut	4,800	1	86160 •

• Non-stock product, contact Customer Service for lead-times.



86148

END BRUSH - Crimped Ceramic Filament - 1/4" Stem
For spot-facing or cleaning in tight areas.

Diameter	Filament Dia./Grit	Trim Length	Overall Length	Max. RPM	Standard Pack	Item Number
1"	.055/80	1/4"	3-3/32"	4,800	10	86148 •

• Non-stock product, contact Customer Service for lead-times.



86159

CONTROLLED FLARE END BRUSH - Crimped Ceramic Filament - 1/4" Stem
For cleaning corners and tight areas.

Diameter	Filament Dia./Grit	Trim Length	Overall Length	Max. RPM	Standard Pack	Item Number
1"	.035/80	1-1/8"	2-1/2"	4,800	10	86159 •

• Non-stock product, contact Customer Service for lead-times.



86171

CONFLEX BRUSHES - Crimped Ceramic Filament - 1/4" Stem
For O.D. and I.D. cleaning in confined areas.

Diameter	Filament Dia./Grit	Face Width	Trim Length	Max. RPM	Standard Pack	Item Number
3"	.043/120	1"	15/16"	4,800	10	86171 •
3"	.055/80	1"	15/16"	4,800	10	86172 •

• Non-stock product, contact Customer Service for lead-times.



44144



95016

HAND SCRATCH BRUSHES - Crimped Ceramic Filament - For general purpose, light-duty cleaning.

Overall Length	Block Type	Brush Part	Grit Size	Trim Length	Standard Pack	Item Number
10"	Wood	5"	80	3/4"	12	44144 •
8-3/4"	Wood	2 x 9 Rows	120	5/8"	36	95016 •

• Non-stock product, contact Customer Service for lead-times.

NOTE

Nylon abrasive filament brushes require a lower operating RPM than most other power tool accessories and they cannot be used effectively on standard grinders.

WE ENDING READY

WHAT YOU NEED. WHEN YOU NEED IT.

We understand that a successful vending program requires products that fit into a machine without hassle and dispense properly, every time. Weiler now offers single pack quantities of vending-ready products. Our packaging eliminates the need to re-pack products, which can be both expensive and time consuming.

In addition to single packs, Weiler's products are also available in small intermediate pack quantities for easy refill. This minimizes the handling from your storage location all the way to the end-user. Our products come the way you need them, ready to load into vending machines.

QUALITY:

The same high performance Weiler products you know and trust now available for vending.

PROVEN:

Our Weiler vending products are guaranteed to work within all Helix-coil vending machines.

CONVENIENT:

We package and ship in easily refillable quantities, reducing your costs.

RELIABLE:

All vending products guaranteed in-stock for quick, reliable shipping anywhere at any time.



Our vending program drives cost out of the supply chain for our business partners by simplifying the vending process.



13106V

P STANDARD TWIST WHEELS Provide heavy-duty brushing action on somewhat irregular surfaces.



Dia.	Wire Size	Arbor Hole	No. of Knots	Face Width	Trim Length	Max. RPM	Intermediate Pack	Item Number	
								Steel	Stainless
3"	.014	1/2"-3/8"	20	3/8"	5/8"	25,000	5	08014V •	08264V •
4"	.014 .020	5/8"-11 UNC	24	1/2"	7/8"	20,000	5	13106V • 13120V	13113V -

• Non-stock product, contact Customer Service for lead-times.



13266V

P CABLE TWIST WHEELS Provide heavy-duty brushing action on relatively smooth surfaces.



Dia.	Wire Size	Arbor Hole	No. of Knots	Face Width	Trim Length	Max. RPM	Intermediate Pack	Item Number
								Steel
4"	.020	5/8"-11 UNC 1/2"-3/8"	24	1/4"	7/8"	20,000	5	13266V 08534V •
6"	.023	5/8"-1/2"	24	3/8"	1-3/8"	9,000	5	08565V •

• Non-stock product, contact Customer Service for lead-times.



13131V

P ROUGHNECK® STRINGER BEAD WHEELS - The go to for high-performance weld cleaning.



Dia.	Wire Size	Arbor Hole	No. of Knots	Face Width	Trim Length	Max. RPM	Intermediate Pack	Item Number	
								Steel	Stainless
Root Pass Brushes									
4"	.020	5/8"-11 UNC	32	3/16"	7/8"	20,000	5	13131V •	13138V •
4-1/2"	.020	5/8"-11 UNC	38	3/16"	13/16"	12,500	5	13232V	-
5"	.020	5/8"-11 UNC	38	3/16"	7/8"	12,500	5	08756V •	08806V
6"	.020	5/8"-11 UNC	48	3/16"	1-1/8"	12,500	1	08766V †	-
6"			56					09400V	-
7"	.020	5/8"-11 UNC	56	3/16"	1-1/8"	9,000	1	09000V	-

Filler Pass Brushes									
6"	.023	5/8"-11 UNC	24	1/2"	1-3/8"	12,500	1	08776V	-

† Light-duty

• Non-stock product, contact Customer Service for lead-times.



08776V



17687V

P STEM MOUNTED KNOT WHEELS - 1/4" stem - Ideal for somewhat irregular surfaces.



Dia.	Wire Size	No. of Knots	Face Width	Trim Length	Max. RPM	Intermediate Pack	Item Number	
							Steel	Stainless
3-1/4"	.014	20	3/8"	5/8"	25,000	1	17681V •	-
4"	.014	24	1/2"	7/8"	20,000	5	17687V •	-

• Non-stock product, contact Customer Service for lead-times.

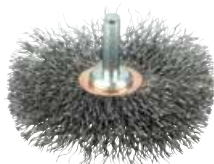

17616V

P CONFLEX BRUSHES - Copper center wheels mounted onto a 1/4" stem provide very flexible brushing.



Dia.	Wire Size	Face Width	Trim Length	Max. RPM	Intermediate Pack	Item Number		
						Steel	Stainless	Brass
2"	.0118	3/8"	1/2"	20,000	1	17610V •	17611V •	-
3"	.008	1/2"	1"	20,000	1	17615V •	-	-
	.0118					17616V •	-	17641V
	.014					-	17618V •	-

• Non-stock product, contact Customer Service for lead-times.

Key:
P Performance line
 Industrial Grade

P

KNOT WIRE CUP BRUSHES Provide heavy-duty brushing action on relatively flat surfaces.



Diameter	Wire Size	Arbor Hole	Trim Length	Max. RPM	Intermediate Pack	Item Number	
						Steel	Stainless
2-3/4"	.014	5/8"-11 UNC	1"	14,000	1	13025	—
	.020					13286	13258
3-1/2"	.023	5/8"-11 UNC	7/8"	13,000	1	13156	13163
4"	.023	5/8"-11 UNC	1-1/4"	10,200	1	12316	—
5"	.023	5/8"-11 UNC	1-3/8"	9,000	1	12276 *	—
6"	.014	5/8"-11 UNC	1-3/8"	6,600	1	12356	—
	.023					12376	—

* With internal nut



13156

12376

P

CRIMPED CUP BRUSHES Provide consistent performance on light-duty cleaning applications.



Diameter	Wire Size	Arbor Hole	Trim Length	Max. RPM	Intermediate Pack	Item Number
						Steel
3"	.014	5/8"-11 UNC	1"	14,000	1	13245
3-1/2"	.014	5/8"-11 UNC	7/8"	12,000	1	13181
4"	.014	5/8"-11 UNC	1-3/8"	10,200	1	14026
5"	.014	5/8"-11 UNC	1-1/4"	9,000	1	14206
6"	.014	5/8"-11 UNC	1-1/4"	6,600	1	14066 *

* With internal nut



13245

P

UTILITY CRIMPED WIRE CUP BRUSHES - Small diameter cup brushes for use on air tools.



Diameter	Wire Size	Trim Length	Overall Length	Max. RPM	Intermediate Pack	Item Number
						Steel
1-3/4"	.0118	3/4"	2-5/16"	13,000	1	14301V
2-3/4"	.0118	7/8"	2-1/2"	6,000	1	14302



14301V

P

CIRCULAR FLARED END BRUSH - Suited for broad and slightly contoured surfaces.



Diameter	Wire Size	Max. RPM	Intermediate Pack	Item Number
				Steel
3"	.008	16,000	1	10041V



10041V

P

KNOT WIRE END BRUSHES Provide heavy-duty brushing action in recessed areas.



Diameter	Wire Size	Trim Length	Overall Length	Max. RPM	Intermediate Pack	Item Number	
						Steel	Stainless
3/4"	.020	7/8"	2-5/8"	22,000	3	10026V •	—
	.014					—	10029V •
1-1/8"	.014	7/8"	2-5/8"	22,000	3	10027V •	10031V
	.020					10028V •	—
	.006					1-1/8"	2-9/16"

* Globally sourced product

• Non-stock product, contact Customer Service for lead-times.



10026V

P

CRIMPED WIRE END BRUSHES - Solid end construction for cleaning hard-to-reach areas.



Diameter	Wire Size	Trim Length	Overall Length	Max. RPM	Intermediate Pack	Item Number	
						Steel	Stainless
1/2"	.006	7/8"	2-9/16"	25,000	3	10001V •	10013V
3/4"	.006	7/8"		22,000	3	10005V •	10017V •
	.020					10008V •	—
	.0104					10009V •	10021V
1"	.006	1"	2-13/16"	22,000	3	10010V •	10022V
	.0104		2-5/8"			10012V •	—
	.020		1-1/8"			2-15/16"	—

• Non-stock product, contact Customer Service for lead-times.



10009V

WHY WEILER
BONDED ABRASIVES
COATED ABRASIVES
NON-WOVEN ABRASIVES
POWER BRUSHES
NYLON BRUSHES
PACKAGED ITEMS
MAINTENANCE



P **ROUND TUBE BRUSHES** - Crimped wire fill provides flexible brushing action.



21077V



21110V

Diameter	Wire Size	Brush Part	Stem Diameter	Overall Length	Intermediate Pack	Item Number	
						Steel	Stainless
1/4"	.004	1"	1/8"	3-1/2"	3	-	21081V
3/8"	.004	1"	1/8"	3-1/2"	3	21073V •	-
1/2"	.005	1"	3/16"	3-1/2"	3	21074V	-
5/8"	.005	1"	3/16"	3-1/2"	3	21075V	-
7/8"	.006	1"	7/32"	3-1/2"	3	21077V	-
1"	.008	1"	1/4"	3-1/2"	3	21078V	-
Double Stem, Double Spiral							
1/2"	.006	2"	5/32"	5"	6	21107V •	-
5/8"	.005	2"	7/32"	5"	6	21108V	-
3/4"	.006	2-1/2"	1/4"	5-1/2"	6	21110V	-
1"	.006	2-1/2"	1/4"	5-1/2"	6	21114V	-

• Non-stock product, contact Customer Service for lead-times.

P **INTERNAL TUBE FITTING BRUSHES** - Wire Fill - For internal cleaning and deburring of copper tube fittings.



44080V

Tube Diameter	Actual Diameter	Brush Length	Overall Length	Handle Length	Intermediate Pack	Item Number
3/8"	1/2"	1"	6-1/2"	3-1/4"	6	44080V

P **ACID BRUSHES** - Horsehair - Tin ferrule (unit packs of 4)



44089V

Width	Trim Length	Overall Length	Intermediate Pack	Item Number
5/16"	3/4"	5-3/4"	6	44088V
3/8"	3/4"	5-3/4"	6	44089V
1/2"	3/4"	5-3/4"	6	44090V

P **SCRATCH BRUSHES** - Ideal for cleaning and prepping surfaces.



44063

Block Size	Brush Length	No. of Rows	Trim Length	Overall Length	Intermediate Pack	Item Number
Steel Wire						
10" x 1-1/8"	5"	4 x 16	1-3/16"	10"		44063
14" x 7/8"	5-1/2"	3 x 19	1-3/16"	14"	1	44053
Stainless Steel Wire						
10" x 1-1/8"	5"	4 x 16	1-3/16"	10"	1	44064
14" x 7/8"	5-1/2"	3 x 19		14"		44054

P **SMALL SCRATCH BRUSHES** - Ideal for cleaning and prepping surfaces. (unit packs of 3)



44167V

44189V

44637V

Block Size	Block	No. of Rows	Wire Size	Trim Length	Overall Length	Intermediate Pack	Item Number
Stainless Steel Wire							
7-1/2" x 1/2"	Plastic Wood	3 x 7	.006	1/2"	7-1/2"	5	44075V • 44167V
Straight Brass Wire							
7-1/2" x 1/2"	Wood	3 x 7	.006	1/2"	7-1/2"	5	44189V •
Straight Black Nylon							
7-1/2" x 1/2"	Wood	3 x 7	.012	1/2"	7-1/2"	5	44637V •

• Non-stock product, contact Customer Service for lead-times.

**WHAT YOU NEED.
WHEN YOU NEED IT.**



Key:

P Performance line
Industrial Grade

V Value line
Professional Grade

P SABER TOOTH™ FLAP DISC - (Type 29) – Cool, fast cutting. 

Diameter	Arbor Hole	Grit Size	Max. RPM	Intermediate Pack	Item Number
Ceramic Alumina Grain, Phenolic Backing					
4-1/2"	5/8"-11 Nut	40	13,000	5	50105V
		60			50106V



50105V

P TIGER® X FLAP DISC - (Type 29) - Maximum aggression & long life. 

Diameter	Arbor Hole	Grit Size	Max. RPM	Intermediate Pack	Item Number
Zirconia Alumina Grain, Phenolic Backing					
4-1/2"	7/8"	40	13,000	5	51201V •
		60			51202V •
4-1/2"	5/8"-11 Nut	40	13,000	5	51205V •
		60			51206V •



51201V

• Non-stock product, contact Customer Service for lead-times.

P BIG CAT® FLAP DISC - High Density (Type 27) – Increased conformability and maximum life. 

Diameter	Arbor Hole	Grit Size	Max. RPM	Intermediate Pack	Item Number
Zirconia Alumina Grain, Phenolic Backing					
4-1/2"	7/8"	40	12,000	5	50803V
		60			50804V
4-1/2"	5/8"-11 Nut	40	12,000	5	50808V
		60			50809V



50804V

P TIGER FLAP DISC - (Type 29) - Maximum aggression & long life. 

Diameter	Arbor Hole	Grit Size	Max. RPM	Intermediate Pack	Item Number
Zirconia Alumina Grain, Aluminum Backing					
4-1/2"	7/8"	40	13,000	5	50513V
		60			50514V
4-1/2"	5/8"-11 Nut	40	13,000	5	50518V
		60			50519V



50513V

P TRIMMABLE TIGER® FLAP DISC - (Type 29) – Trimmable backing for extended disc life. 

Diameter	Arbor Hole	Grit Size	Max. RPM	Intermediate Pack	Item Number
4-1/2"	5/8"-11 Nut	40	13,000	5	50006V
		60			50007V



50007V

P TIGER PAW™ FLAP DISC - (Type 29) – 100% Zirconia Alumina grain for performance & long life. 

Diameter	Arbor Hole	Grit Size	Max. RPM	Intermediate Pack	Item Number
4-1/2"	7/8"	40	13,000	5	51119V
		60			51120V
4-1/2"	5/8"-11 Nut	40	13,000	5	51124V
		60			51125V



51120V

V WOLVERINE® MOUNTED FLAP WHEELS - 1/4" Stem – Provide fast action at a value price. 

Diameter	Width	Grit Size	Max. RPM	Intermediate Pack	Item Number
1"	1"	60	30,000	3	30720V
		80			30721V
2"	1"	60	25,000	1	30723V
		80			30724V
		80			30726V
3"	1"	60	23,000	1	30727V



30726V

DISPLAY READY

Weiler industrial grade items are available in highly visible packaging, ready to hang on a display. Customers can see products and compare specifications, enabling them to easily pick the right product for the job. Package labeling includes important technical information and UPC bar codes. A multi-lingual safety slip is included with all products, providing comprehensive information on the safe use of the product.

FOR IN-STORE DISPLAY SOLUTIONS
contact your Weiler District Sales Manager.



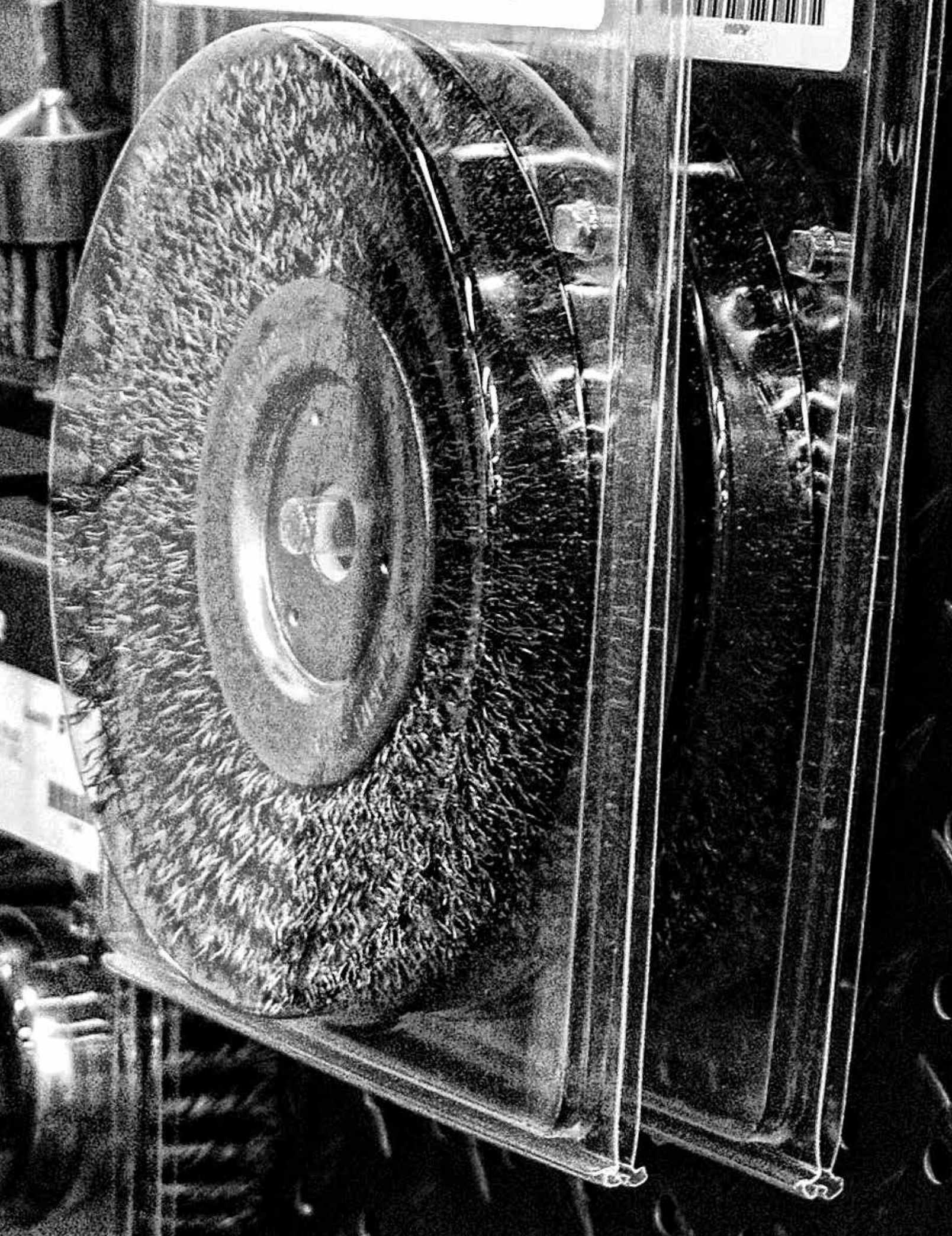



13106P

P STANDARD TWIST WHEELS provide heavy-duty brushing action with some flexibility; ideal for demanding cleaning applications on somewhat irregular surfaces.



Dia.	Wire Size	Arbor Hole	No. of Knots	Face Width	Trim Length	Max. AH Avail.	Thickness at Face Plates	Max. RPM	Std. Pack	Item Number	
										Steel	Stainless
3"	.014	1/2"-3/8"	20	3/8"	5/8"	1/2"	7/16"	25,000	1	08014P	—
4"	.014	1/2"-3/8"	24	1/2"	7/8"	1/2"	7/16"	20,000	1	08044P	—
4"	.014	5/8"-11	24	1/2"	7/8"	—	7/16"	20,000	1	13106P	13113P
6"	.014	5/8"-1/2"	24	1/2"	1-3/8"	1-1/4"	9/16"	9,000	1	08085P	—

• Non-stock product, contact Customer Service for lead-times.



13266P

P CABLE TWIST WHEEL provides maximum brushing action with minimal flexibility; ideal for demanding cleaning and surface preparation applications on smooth surfaces.



Dia.	Wire Size	Arbor Hole	No. of Knots	Face Width	Trim Length	Max. AH Avail.	Thickness at Face Plates	Max. RPM	Std. Pack	Item No.
										Steel
4"	.020	5/8"-11 UNC	24	1/4"	7/8"	1/2"	7/16"	20,000	1	13266P



13131P

P ROUGHNECK® STRINGER BEAD WHEELS - Maximum impact action for fast removal of slag, spatter, oxidation as well as other surface prep and cleaning applications.



Diameter	Wire Size	Arbor Hole	No. of Knots	Face Width	Trim Length	Thickness at Face Plates	Max. RPM	Standard Pack	Item Number	
									Steel	Stainless
4"	.020	M10 x 1.25	32	3/16"	7/8"	7/16"	20,000	1	13125P	—
		5/8"-11 UNC							13131P	13138P
6"	.020	5/8"-11 UNC	56	3/16"	1-1/8"	7/16"	12,500	1	09400P	—
	.023	5/8"-11 UNC	24	1/2"	1-3/8"	9/16"	—	—	08776P	—
7"	.020	5/8"-11 UNC	56	3/16"	1-1/8"	7/16"	9,000	1	09000P	—

• Non-stock product, contact Customer Service for lead-times.



01075P

P CRIMPED WIRE WHEELS provide a flexible brushing action and consistent performance for demanding light-duty cleaning and deburring applications.



Dia.	Wire Size	Arbor Hole	Face Width	Trim Length	Max. AH Avail.	Thickness at Face Plates	Max. RPM	Std. Pack	Item Number
									Steel
6"	.014	5/8"-1/2"	3/4"	1-7/16"	1-1/4"	7/16"	6,000	1	01075P
			5/8"	1-1/16"	—	1/2"			02325P
			7/8"	1-1/8"	—	7/8"			06645P
7"	.014	5/8"-1/2"	3/4"	1-9/16"	—	1/2"	6,000	1	02335P
8"	.014	5/8"	3/4"	2-1/16"	1-1/4"	1/2"	6,000	1	01175P

• Non-stock product, contact Customer Service for lead-times.

P **CONFLEX BRUSHES** - Small diameter copper center wheels permanently mounted onto a 1/4" stem to provide a very flexible brushing action.



Diameter	Wire Size	Face Width	Trim Length	Max. RPM	Standard Pack	Item Number
						Steel
3"	.008	1/2"	1"	20,000	1	17615P •
	.014					17617P •

• Non-stock product, contact Customer Service for lead-times.



17617P

P **KNOT WIRE CUP BRUSHES - Single Row** - Provide heavy-duty brushing action with some flexibility; ideal for demanding cleaning applications on relatively flat surfaces.



Diameter	Wire Size	Arbor Hole	Trim Length	Max. RPM	Standard Pack	Item Number
						Steel
2-3/4"	.014	5/8"-11 UNC	1"	14,000	1	13025P
2-3/4"	.020	M10 x 1.25	1"	14,000	1	13281P •
		5/8"-11 UNC				13286P
3-1/2"	.023	5/8"-11 UNC	7/8"	13,000	1	13156P
4"	.023	5/8"-11 UNC	1-1/4"	10,200	1	12316P
5"	.023	5/8"-11 UNC	1-3/8"	7,000	1	12276P* •
6"	.023	5/8"-11 UNC	1-3/8"	6,600	1	12376P

* With internal nut

• Non-stock product, contact Customer Service for lead-times.



12316P

P **CRIMPED WIRE CUP BRUSHES** provide very flexible brushing action and the most consistent performance for demanding light-duty cleaning applications; feature a threaded nut for use on angle grinders.



Diameter	Wire Size	Arbor Hole	Trim Length	Max. RPM	Standard Pack	Item Number
						Steel
3"	.014	M10 x 1.25	1"	14,000	1	13240P •
		5/8"-11 UNC				13245P
4"	.020	5/8"-11 UNC	1-3/8"	9,000	1	14036P
6"	.020	5/8"-11 UNC	1-1/4"	6,600	1	14076P* •

* With internal nut

• Non-stock product, contact Customer Service for lead-times.



13245P

P **THREADED ADAPTERS** - For mounting brushes with a 5/8"-11 UNC nut to other threaded spindles.

Fixed Thread Size	Adapted Thread Size	Standard Pack	Item Number
5/8" - 11 UNC	M10 x 1.25	1	07771P
5/8" - 11 UNC	M10 x 1.50	1	07772P



07771P

Key:

P Performance line
 Industrial Grade

V Value line
 Professional Grade



10028P

P **KNOT WIRE END BRUSHES** - Feature a hollow end and heavy-duty brushing action with some flexibility; ideal for more demanding cleaning applications in recessed areas.



Diameter	Wire Size	Trim Length	Overall Length	Max. RPM	Standard Pack	Item Number
						Steel
3/4"	.014	1-1/8"	2-5/8"	22,000	1	10025P •
	.020					10026P
1-1/8"	.014	7/8"	2-5/8"	22,000	1	10027P
	.020					10028P

• Non-stock product, contact Customer Service for lead-times.



10012P

P **CRIMPED WIRE END BRUSH** - Feature a solid end construction and very flexible brushing action ideal for more demanding light-duty cleaning applications in corners and hard-to-reach areas.



Diameter	Wire Size	Trim Length	Overall Length	Max. RPM	Standard Pack	Item Number
						Steel
3/4"	.020	7/8"	2-9/16"	22,000	1	10008P •
1"		1-1/8"	2-5/8"	20,000		10012P •

• Non-stock product, contact Customer Service for lead-times.

Key:

P Performance line
Industrial Grade

V Value line
Professional Grade

P

MINI-GRINDER KIT - For use on small right angle grinders. All products have a 5/8"-11 Arbor Hole



Kit Contains	Item Number
4-1/2" Abrasive Flap Disc (Zirconium Grain, 60 Grit); Item #50519: For grinding and finishing in one step.	13001
2-3/4" Knot Wire Cup Brush (.020 Steel Wire); Item #13286: For cleaning large surface areas.	
4" Stringer Bead Knot Wire Wheel (.020 Steel Wire); Item #13131 For weld cleaning, deburring and surface preparation.	



13001

P

AIR TOOL/DRILL ACCESSORY KIT -All products have a 1/4" Stem and are ideal for general purpose cleaning and deburring in recessed or confined areas.



Kit Contains	Item Number
3" Crimped Wire Wheel (.0118 Steel Wire); Item #17616	13002
1-3/4" Crimped Wire Cup Brush (.0118 Steel Wire); Item #14301	
3/4" Crimped Wire End Brush (.020 Steel Wire); Item #10008	
3" Abrasive Flap Wheel (Aluminum Oxide Grain, 80 Grit); Item #52028	



13002

P

STAINLESS STEEL SCRATCH BRUSH COUNTERTOP DISPLAY

Ideal for removing rust, scale and paint from metal surfaces.

Display Contains	Item Number
(36) Stainless Steel Small Hand Scratch Brushes, 7-1/2" x 1/2" Block Wood Handle; Item #44167	61012



61012

WHY WEILER BONDED ABRASIVES

COATED ABRASIVES

NON-WOVEN ABRASIVES

POWER BRUSHES

NYLOX BRUSHES

PACKAGED ITEMS

MAINTENANCE



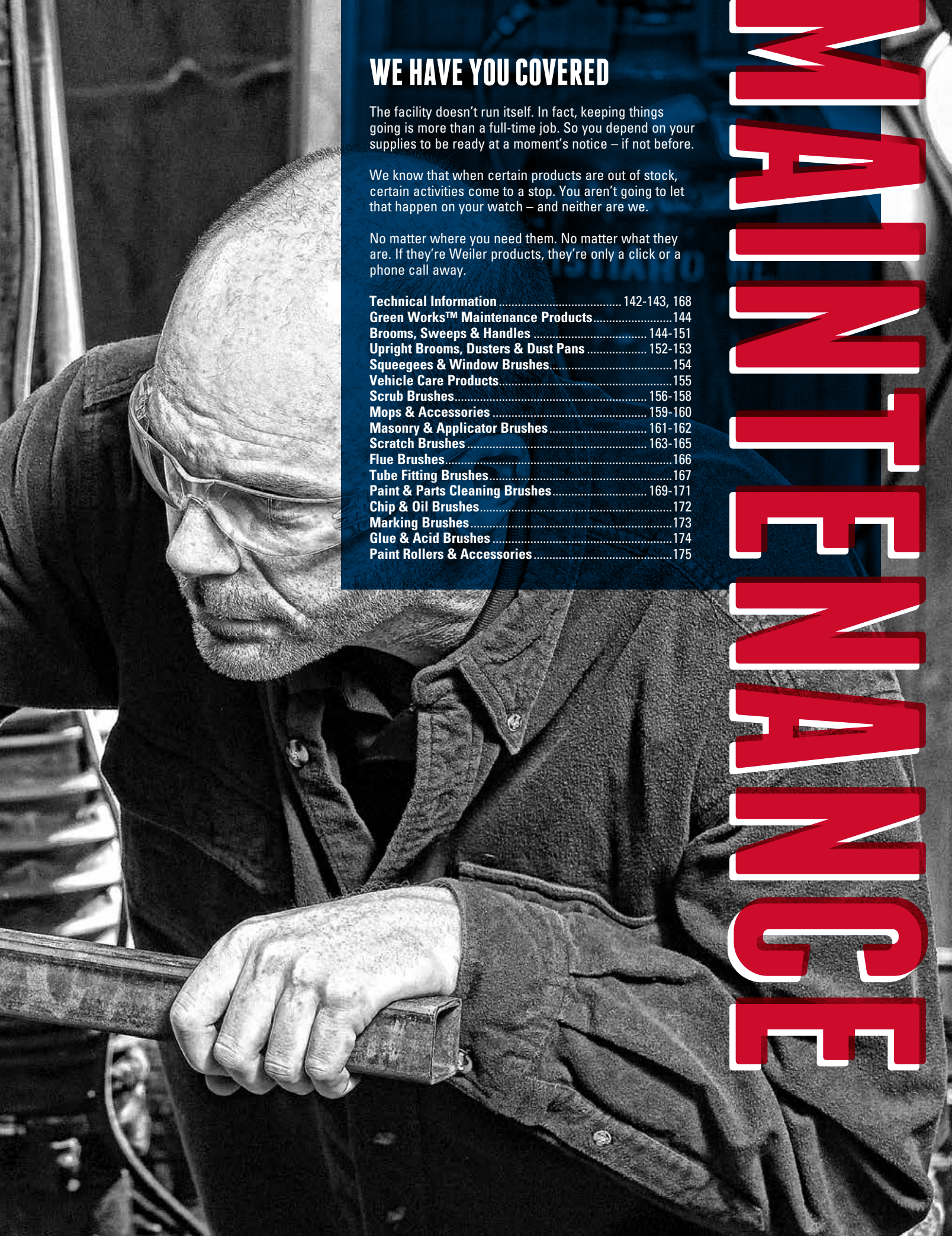

WE HAVE YOU COVERED

The facility doesn't run itself. In fact, keeping things going is more than a full-time job. So you depend on your supplies to be ready at a moment's notice – if not before.

We know that when certain products are out of stock, certain activities come to a stop. You aren't going to let that happen on your watch – and neither are we.

No matter where you need them. No matter what they are. If they're Weiler products, they're only a click or a phone call away.

Technical Information	142-143, 168
Green Works™ Maintenance Products	144
Brooms, Sweeps & Handles	144-151
Upright Brooms, Dusters & Dust Pans	152-153
Squeegees & Window Brushes	154
Vehicle Care Products	155
Scrub Brushes	156-158
Mops & Accessories	159-160
Masonry & Applicator Brushes	161-162
Scratch Brushes	163-165
Flue Brushes	166
Tube Fitting Brushes	167
Paint & Parts Cleaning Brushes	169-171
Chip & Oil Brushes	172
Marking Brushes	173
Glue & Acid Brushes	174
Paint Rollers & Accessories	175

MAINTENANCE

SELECTING THE RIGHT BRUSH





P PERFORMANCE LINE (INDUSTRIAL GRADE)

Engineered and manufactured to maximize performance and minimize operating costs in the most demanding surface conditioning applications. The use of superior construction, the highest quality materials and the most stringent manufacturing processes deliver the lowest cost-of-use and most consistent performance in heavy production environments.

V VALUE LINE (PROFESSIONAL GRADE)

Weiler's value line is manufactured using similar product construction and the same exacting standards as other Weiler maintenance products, but engineered to provide cost-effective use specifically designed for the professional, providing a cost-effective price. Vortec Pro® maintenance products are an economical choice for the construction trades, low volume production shops and light-duty industrial MRO use.

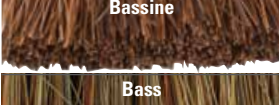
FILL MATERIALS GUIDE

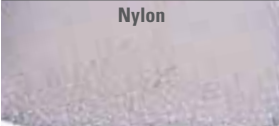
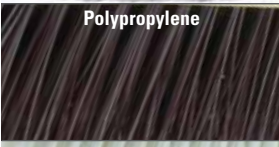
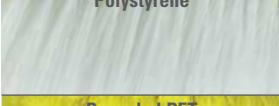
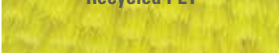
	Type	Advantages	Applications	Notes
ANIMAL	 Horsehair	<ul style="list-style-type: none"> • Very durable and resilient • Naturally flagged tips • Resistant to high temperatures (to 370°F) • Can be blended with other materials • Fine texture 	<ul style="list-style-type: none"> • Fine particles • Ideal for polished and smooth surfaces • Scratch-free sweeping 	<ul style="list-style-type: none"> • Not for use on oily or wet surfaces
NATURAL	 Tampico	<ul style="list-style-type: none"> • Material holds water very well • Heat, alkali and acid resistant (to 283°F) • Soft to medium texture • Good durability 	<ul style="list-style-type: none"> • Polishing, buffing and cleaning • Scrubbing and washing • Ideal for wet and dry applications 	<ul style="list-style-type: none"> • Natural color is off white • Can be dyed or bleached
	 Palmyra	<ul style="list-style-type: none"> • Softer and finer texture than Bassine • More economical than Bassine • Medium to coarse texture • Good durability 	<ul style="list-style-type: none"> • Used in garage, scrub, deck and patio brushes • Ideal for wet and dry applications 	<ul style="list-style-type: none"> • Brown in color
	 Bassine	<ul style="list-style-type: none"> • Coarse, tough fibers • Excellent durability 	<ul style="list-style-type: none"> • Heavy scrubbing and cleaning • Tasks requiring a tough, long-lasting natural fiber 	<ul style="list-style-type: none"> • Dark brown in color
	 Bass	<ul style="list-style-type: none"> • Good flexibility • Very coarse, tough fibers • Excellent durability 	<ul style="list-style-type: none"> • Heavy-duty cleaning applications • Use on rough surfaces 	<ul style="list-style-type: none"> • Dark brown in color
SYNTHETIC	 Nylon	<ul style="list-style-type: none"> • Excellent durability • Resistant to most acids & alkali • High water absorbency • Resistant to high temperatures (to 350°F) • Best man-made fiber to resist fatigue 	<ul style="list-style-type: none"> • Heavy-duty industrial • Scrubbing and cleaning • Wet and dry applications 	<ul style="list-style-type: none"> • May be level or crimped
	 Polypropylene	<ul style="list-style-type: none"> • Very durable • Acid, oil, bacteria and fungus resistant • Versatile • Resistant to high temperatures (to 225°F) • Will not absorb moisture 	<ul style="list-style-type: none"> • Variety of medium to coarse industrial applications 	<ul style="list-style-type: none"> • May be level or crimped
	 Polystyrene	<ul style="list-style-type: none"> • Extremely durable • Liquid and oil resistant • Resistant to temperatures (to 180°F) • Ends can be flagged 	<ul style="list-style-type: none"> • Used in vehicle care brushes • Used in fruit and vegetable wash brushes • Wet and dry applications 	<ul style="list-style-type: none"> • May be level or crimped • Not for use with sweeping compounds
	 Recycled PET	<ul style="list-style-type: none"> • Environmentally-friendly • Less landfill waste 	<ul style="list-style-type: none"> • Fine, Medium & Coarse • For a variety of applications 	<ul style="list-style-type: none"> • Fill made from recycled water bottles

FLOOR BRUSH SELECTION GUIDE

Surface Type	Debris	Recommended Brush
Tile, linoleum, highly polished	Fine dust	Black horsehair
Smooth wood	Fine to medium dirt	Flagged silver polystyrene
Smooth concrete	Fine to medium dirt	Black polypropylene
Uneven or rough floors, heavy traffic areas	Medium to heavy dirt and debris	Black tampico
Rough concrete, asphalt	Heavy, caked dirt, grease, litter	Black tampico - inner row of steel wire or palmyra

FLOOR BRUSH FEATURES

Block: Fill material is set into this part of the sweep.

Synthetic Foam Block:

- Made with a synthetic cellular core surrounded by a solid skin.
- Will not crack, split, warp or house contaminating bacteria.
- Water, solvent and mild acid resistant.
- Lighter weight than hardwood blocks.

Lacquered Hardwood Block:

- Made of natural, kiln-dried hardwood.
- Resists moisture.
- Helps prevent cracking, increasing brush life.

Dense Fill:

- Set into the block and serves as the actual working part of the brush.
- More efficient sweeping.
- Longer brush life.

Reorder Number:

- Shown on block.

Two Handle Holes:

- Allows user to change sweeping direction to prevent the fill material from setting in one direction. Periodically changing sweeping direction increases the life of the brush.

Staggered Hole Pattern:

- Prevents gaps in the fill material so brush sweeps up all the dirt in its path.



Flagged Tips:

- Each synthetic filament end is mechanically split, forming multiple tips which "pick up" fine dust and dirt particles. Horsehair has naturally tapered or flagged tips.



Center / Border Fill



Border (Casing)
Moves fine dust and dirt

Center
Loosens and moves heavy dirt

Solid Brush Face with Flared Ends:

- The tufts of fill material on each end of a contractor, floor, garage or street brush are flared outward.
- Flared ends allow the brushing material to get into corners without marking or scraping the wall with the block.
- Prevents a gap in the middle of the brush.

FLOOR BRUSH CARE

Storage - Floor brushes should be hung when not in use so no weight is against the fill material. This will help keep the shape and prolong the life of the brush.

Handles - The handle should be periodically re-positioned from one staff hole to the other to prevent fill material from setting in one position. The use of a brace will help prevent handle breakage. Perma-Flex™ (#44301) handles are guaranteed to outlast the life of the brush.

Blocks - Avoid knocking a wood block against the floor to remove embedded material, as this will damage the end of the block.

Cleaning - Synthetic filled brushes can be cleaned with detergent and water. Fiber filled brushes should be combed to remove dirt and other foreign material. Dip coarse natural fiber brushes in water to help prevent breakage due to dry fiber.

GREEN WORKS™ MAINTENANCE PRODUCTS



36 billion water bottles end up in landfills every year. Help us make a difference!

Sustainable, recyclable, environmentally-friendly, Green - all of these come to mind with the new Green Works line from Weiler. Made from recycled or sustainable raw materials, the Green Works line is manufactured in a LEED (Leadership in Energy & Environmental Design) approved facility to ensure that even the production environment is environmentally-friendly. All of this, plus the same great performance! Every product is made to the quality levels you expect when you hear the name Weiler.

Green Works Product Construction:

- Fill material is made out of recycled water bottles, giving a second life to these waste products and helping to clean up the environment.
- Rubberwood blocks are made from the wood of rubber trees that have ended their life cycle in the rubber production industry. We are putting the waste product of that industry to good use.
- Foam blocks are made from recycled plastics.
- Handles are made from bamboo - a very strong and durable natural resource that replenishes at a very rapid rate in the environment.

P FLOOR SWEEPS - Choose from flagged tips that pick-up fine dust and dirt to durable fibers that sweep heavy, caked dirt and debris.

Block Size	Block Type	Fill Material	Trim Length	Standard Pack	Item Number
Fine Sweeping - For fine dust and dirt on smooth surfaces					
24"	Recycled Black Foam	Recycled Grey Fill	3"	12	42352
24"	Renewable Rubberwood	Recycled Grey Fill	3"	12	42355
Medium Sweeping - For general purpose sweeping on semi-smooth surfaces					
24"	Recycled Black Foam	Recycled Blue Fill	3"	12	42353
24"	Renewable Rubberwood	Recycled Blue Fill	3"	12	42356
Coarse Sweeping - For heavy dirt and debris on very rough surfaces					
24"	Recycled Black Foam	Recycled Maroon Fill	3"	12	42354
24"	Renewable Rubberwood	Recycled Maroon Fill	3"	12	42357

Handle #42380 or #42381 are recommended for use with these sweeps.

P STREET BROOM - Ideal for wet or dry sweeping on streets, parking lots, loading docks and driveways.

Block Size	Block Type	Fill Material	Trim Length	Standard Pack	Item Number
16"	Renewable Rubberwood	Recycled Black Fill	6"	6	42360

Handle #42382 is recommended for use with this broom.

P DUO SWEEP - Heavy-duty upright with two handle holes - one straight and one angled.

Size	Block Type	Fill Material	Trim Length	Standard Pack	Item Number
9"	Recycled Black Foam	Recycled Yellow Fill	7"	12	42365

Handle #42383 is recommended for use with this sweep. See page 150 for details.

P COUNTER DUSTER - Ideal for quick clean-ups. Features a comfortable grip handle.

Block Size	Block Type	Fill Material	Trim Length	Overall Length	Std. Pack	Item Number
8"	Recycled Black Foam	Recycled Grey Fill	2-1/2"	13-1/8"	12	42368

P SCRUB BRUSHES - Designed to provide the most effective brushing and cleaning action.

Block Size	Type	Block Type	Fill Material	Standard Pack	Item Number
8"	Utility	Recycled Black Foam	Recycled Yellow Fill	12	42375
9"	Pointed Deck	Renewable Rubberwood	Recycled Yellow Fill	12	42373
10"	Deck	Renewable Rubberwood	Recycled Yellow Fill	12	42371
	Bi-Level	Recycled Black Foam			42372
20"	Utility	Recycled Black Foam	Recycled Yellow Fill	12	42376

Handle #42380 or #42381 are recommended for use with these scrub brushes.

P SOLID BAMBOO HANDLES - Very strong, abundant source material.

Length	Diameter	Tip Type	Standard Pack	Item Number
5'	7/8"	Threaded Wood	12	42380
5'	7/8"	Threaded Metal	12	42381
5'	1-1/8"	Tapered Wood	12	42382

Key:

P Performance line
Industrial Grade

V Value line
Professional Grade

QUICK ASSEMBLY & UNBREAKABLE!

Easy-to-Assemble: The convenient and easy-to-assemble T-knob construction of the Pro-Flex Sweep takes less than 1 minute to assemble. The handle connects easily and securely to the broom head, and there's no need for a brace!

Unbreakable: Utilizing an advanced polymer technology, the Pro-Flex Sweep's unique handle/sweep connector flexes on impact, providing unbelievable shock absorbency...and it's unbreakable! Ideal for the most demanding applications on a construction site.

More Maneuverable: Without the need for a brace, the Pro-Flex Sweep is lighter, easy to maneuver and eliminates potential damage to low surface areas.

The Pro-Flex Sweep... the strongest sweep on the market AND the easiest to assemble!



Flexible connection makes these sweeps the strongest on the market!



The Pro-Flex Sweep's indestructible design will make it the last sweep you will ever buy!

P PRO-FLEX SWEEPS - Hardwood Block

Includes comfort grip Pro-Flex handle and scraper for removal of heavy, caked dirt and debris.

Block Size	Fill Material	Trim Length	Standard Pack	Item Number
Convenient scraper attaches handle to sweep head for display and shipping purposes				
24"	Flagged Grey Polystyrene Border with Stiff Black Polypropylene Center	3"	1	44600 ■
24"	Palmyra	4"	1	44601 ■
24"	Medium Maroon Polypropylene	3-1/4"	1	44604 ■
24"	Stiff Blue Polypropylene	3-1/4"	1	44606 ■

■ Packaged product available. See pages 136-139 for details.

QUICK ASSEMBLY - NO TOOLS REQUIRED!



Remove nuts from broom assembly



Flip scraper and place over bolts



Place handle connector over bolts and tighten nuts securely



COATED ABRASIVES

NON-WOVEN ABRASIVES

POWER BRUSHES

NYLON BRUSHES

PACKAGED ITEMS

MAINTENANCE

SPECIALTY FLOOR BRUSHES



Sweeping leaves from a garage floor.

P

CONTRACTOR BROOMS - Hardwood Block - Heavy-duty brace included with all brooms. Ideal for construction sites and other heavy use environments.

Block Size	Fill Material	Trim Length	Standard Pack	Item Number
Fine Sweeping - For fine dust and dirt on smooth surfaces				
24"	Flagged Silver Polystyrene	3"	1	44553
Medium Sweeping - For general purpose sweeping on semi-smooth surfaces				
24"	Flagged Grey Polystyrene Border	3"	1	44581
30"	with Stiff Black Polypropylene Center			44582 •
Coarse Sweeping - For heavy dirt and debris on very rough surfaces				
24"	Palmyra	4"	1	44584
24"	Medium Maroon Polypropylene	3-1/4"	1	44587
24"	Stiff Blue Polypropylene	3-1/4"	1	44590
30"				44591 •

• Non-stock product, contact Customer Service for lead-times.

NOTE



- For Contractor Brooms, use Handle No. 44635 (1-1/8" x 60").
- Handle not included in price - order handle separately. See page 150.
- Bolt to assemble broom is included with the broom, not with the handle.



PERMA-SWEEP™ FLOOR BRUSHES - Weiler offers color-coded floor sweeps to make product selection and identification easier. Constructed with foam blocks and synthetic filaments, these materials are durable, resist acid and bacteria and can be used in wet or dry sweeping applications.

P

PERMA-SWEEP - Synthetic Foam Block - Made of durable materials designed to resist acid and bacteria.

Block Size	Fill Material	Trim Length	Standard Pack	Item Number
Fine Sweeping - For fine dust and dirt on smooth surfaces				
18"	Flagged Green Polystyrene	3"	1	42163
24"				42164
Medium Sweeping - For general purpose sweeping on semi-smooth surfaces				
18"	Yellow Polypropylene	3"	1	42165
24"				42166
Coarse Sweeping - For heavy dirt and debris on very rough surfaces				
18"	Maroon Polypropylene	3"	1	42167
24"				42168

NOTE



- For Perma-Sweep Floor Brushes, use Perma-Flex Handle No. 44301 (15/16" x 60") Guaranteed for the life of the brush!
- Handle not included in price - order handle separately. See page 150.



FLOOR BRUSHES

Weiler offers a broad array of floor brushes in various sizes and fill materials for fine, medium and coarse sweeping applications. Choose from flagged tips that pick up fine dust and dirt to durable fibers that sweep heavy-caked dirt and debris. The lacquered hardwood blocks resist moisture and help prevent cracking, thereby increasing brush life.



Sweeping saw dust on a smooth surface.

NOTE



- Handle No. 44300 (15/16" x 60") recommended for use with all Floor Brushes.
- Handle not included in price - order handle separately. See pages 150-151 for additional options.

P FINE SWEEPS - Lacquered Hardwood Block

For dust and fine dirt on smooth surfaces: Tile, Wood, Linoleum, Marble, Ceramic Tile and Smooth Concrete.

Block Size	Fill Material	Trim Length	Standard Pack	Item Number	★ Combo Qty. Item Number
18"	Black Horsehair	3"	1	42001	44855 •
24"				42002	44856 •
18"	Black Horsehair and Black Polypropylene Blend	3"	1	42013	—
24"				42014	—
10"	Flagged Silver Polystyrene	3"	12	70312	—
18"				42041	44857 •
24"				42042	44858 •
36"				42098*	—

★ Combo Packs include 12 sweeps per pack and 12 #44300 handles (not assembled).
* Brace included

• Non-stock product, contact Customer Service for lead-times.



42001

42042

V VORTEC PRO® FINE SWEEPS - Lacquered Hardwood Block

Reliable and efficient sweeps at a value price.

Block Size	Fill Material	Trim Length	Standard Pack	Item Number
18"	Flagged Grey Polystyrene	3"	12	77013
24"				77014



77013

P MEDIUM SWEEPS - Lacquered Hardwood Block

General purpose sweeping on semi-smooth surfaces: Wood, Smooth Concrete, Asphalt and Factory/Shop Floors.

Block Size	Fill Material	Trim Length	Standard Pack	Item Number	★ Combo Qty. Item Number
14"	Black Tampico	3"	1	42114	—
16"				42006	—
18"				42007	44859 •
24"				42008	44860 •
36"				42047*	—
18"	Horsehair Border with Black Tampico Center	3"	1	42016	—
24"				42017	—
36"				42049*	—
18"	Horsehair and Polystyrene Border with Black Polypropylene Center	3"	1	70067	—
24"				70068 •	—
18"	Black Polypropylene	3"	1	42035	44861 •
24"				42037	44862 •
36"				42095*	—

★ Combo Packs include 12 sweeps per pack and 12 #44300 handles (not assembled).
* Brace included

• Non-stock product, contact Customer Service for lead-times.



42007

V VORTEC PRO MEDIUM SWEEPS - Lacquered Hardwood Block

Reliable and efficient sweeps at a value price.

Block Size	Fill Material	Trim Length	Standard Pack	Item Number	★ Combo Qty. Item Number
18"	Dark Grey Polystyrene Border with Black Polypropylene Center	3"	1	25234	44851 •
24"				25235	44852 •
18"	Black Tampico	3"	1	25231	44853 •
24"				25232	44819 •

★ Combo Packs include 12 sweeps per pack and 12 #44300 handles (not assembled).

• Non-stock product, contact Customer Service for lead-times.



25234

COATED ABRASIVES

NON-WOVEN ABRASIVES

POWER BRUSHES

NYLON BRUSHES

PACKAGED ITEMS

MAINTENANCE

P

COARSE SWEEPS - Lacquered Hardwood Block

For heavy dirt and debris on rough surfaces: Wood, Concrete, Asphalt and Brick.

Block Size	Fill Material	Trim Length	Standard Pack	Item Number	★ Combo Qty. Item Number
18"	Black Tampico with 1 row	3"	1	42134	44871 •
24"	Tempered Steel Wire in Center			42135	44872 •

★ Combo Packs include 12 sweeps per pack and 12 #44300 handles (not assembled).

• Non-stock product, contact Customer Service for lead-times.



42135

NOTE



- Handle No. 44300 (15/16" x 60") recommended for use with all Floor Brushes.
- Handle not included in price - order handle separately. See pages 150-151 for additional options.

STRIP BROOMS - The corrosion-resistant frame is lightweight, resulting in less user fatigue! Efficient and economical, Strip Brooms make quick work of dirt and debris on all types of surfaces.

V

VORTEC PRO® STRIP BROOMS - Economy brushes provide lasting, efficient service at minimal cost.

Block Size	Fill Material	Trim Length	Standard Pack	Item Number
Fine Sweeping - For smooth surfaces				
24"	Green Polypropylene	3"	12	25299
Medium Sweeping - For semi-rough surfaces				
18"	Red Polypropylene	3"	12	25290
24"				25291
Coarse Sweeping - For rough surfaces				
18"	Brown Polypropylene	3"	12	25294 •
24"				25295

• Non-stock product, contact Customer Service for lead-times.

NOTE



- For Strip Brooms, use Handle No. 25297 (15/16" x 60").
- Handle not included in price - order handle separately. See page 150.



25299



25290



25294

P

DRIVEWAY COATERS - For applying blacktop driveway and parking lot dressings; asphalt, sealers or roof coatings.

Block Size	Fill Material	Trim Length	Standard Pack	Item Number	★ Combo Qty. Item Number
10"	Black Tampico	2-5/8"	12	73180	-
18"	Palmyra	2"	12	73182*	44885 •

★ Combo Packs include 12 brushes per pack and 12 #75527 handles (not assembled).

• Non-stock product, contact Customer Service for lead-times.

* With squeegee

NOTE



- Handle No. 75527 (7/8" x 48") recommended for Driveway Coaters.
- Handle not included in price - order handle separately. See pages 156-157 for additional options.

Key:

P Performance line
Industrial Grade

V Value line
Professional Grade

P GARAGE BRUSHES - Lacquered Hardwood Block

For wet or dry sweeping heavy, caked dirt and debris on rough surfaces: Concrete, Garage/Factory Floors, Rough Wood, Sidewalks, Barns and Brick Surfaces. Solvent, oil, chemical and liquid resistant.

Block Size	Fill Material	Trim Length	Standard Pack	Item Number	★ Combo Qty. Item Number
16"	Palmyra	4"	1	42021	—
18"				42022	44867 •
24"				42023	44868 •
36"				42138*	—
18"	Maroon Polypropylene	3-1/4"	1	42025	—
24"				42026	—
36"				42149*	—

★ Combo Packs include 12 sweeps per pack and 12 #44300 handles (not assembled).

• Non-stock product, contact Customer Service for lead-times.

* Brace included



Sweeping metal shavings from a shop floor.

V VORTEC PRO® GARAGE BRUSHES - Lacquered Hardwood Block

Reliable and efficient brushes at a value price.

Block Size	Fill Material	Trim Length	Standard Pack	Item Number	★ Combo Qty. Item Number
18"	Palmyra	4"	1	25241	44865 •
24"				25242	44866 •
18"	Maroon Polypropylene	3-1/4"	1	25238	44863 •
24"				25239	44864 •

★ Combo Packs include 12 sweeps per pack and 12 #44300 handles (not assembled).

• Non-stock product, contact Customer Service for lead-times.



42023



42025

NOTE



- Handle No. 44435 (1-1/8" x 60") recommended for use with all Garage Brushes.
- Handle not included in price - order handle separately. See pages 150-151 for additional options.

P STREET BROOMS - Hardwood Block - Wide flared ends for sweeping close to curbs and walls. For heavy-duty wet or dry sweeping: Streets, Sidewalks, Loading Docks, Parking Lots, Driveways and all Asphalt Surfaces.

Block Size	Fill Material	Trim Length	Standard Pack	Item Number	★ Combo Qty. Item Number
16"	Natural Palmyra	6-1/4"	6	70208	—
16"	Dyed Palmyra	6-1/4"	6	70209	—
16"	Bass & Palmyra Blend	6-1/4"	6	42032	44873 •
16"		7-1/4"		42099	—
16"	Brown Polypropylene	5-1/4"	6	42033	44874 •
18"				42173	—
24"				42174	—
16"	Orange Polypropylene	5-1/4"	6	70212	—
18"				42054	—
24"				42055	—
14"	White Polypropylene Fill Orange Block	4"	6	70210	—
16"				70211	—

★ Combo Packs include 12 brooms per pack and 12 #44020 handles (not assembled).

• Non-stock product, contact Customer Service for lead-times.



70209



42032



42033

P WIRE BROOMS - Hardwood Block

For sweeping or scrubbing concrete or stone floors, driveways, etc. Ideal for sweeping heavy chips and debris.

Block Size	Fill Material	Trim Length	Standard Pack	Item Number
14"	Flat Wire	5"	1	42030
16"	Round Wire	3-3/4"	6	70215

NOTE



- Street and wire brooms require a tapered tip handle.
- Handle No. 44020 (1-1/8" x 60") recommended for use with all Street & Wire Brooms.
- Use Spring-Loc Adapter to keep tapered wood handle securely fastened to the block.
- Handle not included in price - order handle separately. See pages 150-151 for adapter and handle.



42030

COATED ABRASIVES
NON-WOVEN ABRASIVES
POWER BRUSHES
NYLON BRUSHES
PACKAGED ITEMS
MAINTENANCE

HANDLES, BRACES & TIPS

Weiler's wood and metal handles are constructed for long life. Handles are available in a large variety of styles and tips to fit a wide selection of block types. The following charts provide recommended uses for each style handle.



The Perma-Flex tip is guaranteed not to break when used with a Perma-Sweep.



44018



44020



44300



44301



25297



44635

P WOOD HANDLES - Quality hardwood

Length	Diameter	Tip	Description	Std. Pack	Item No.
48"	7/8"	Threaded	Use with floor and garage brushes.	12	75527
48"	15/16"	Wood			44571
54"	15/16"				44018
60"	15/16"				44019
72"	15/16"				44303
11"	3/4"	Tapered	Use with masonry and roof brushes, street brooms, floor and deck scrubs and squeegees.	36	75528 •
48"	7/8"	Wood			44574
54"	1-1/8"				44573
60"	1-1/8"				44020
72"	1-1/8"				44306
48"	15/16"	Threaded	Heavy-duty metal tip provides additional strength.	12	75525
60"	15/16"	Metal			44300
60"	1-1/8"				44435
72"	15/16"				44302
48"	15/16"	Perma-Flex™	Durable threaded plastic tip guaranteed not to break when used with Perma-Sweep™ Floor Brushes.	12	75516
60"	15/16"				44301
60"	15/16"	—	Use with Strip Brooms.	12	25297
60"	1-1/8"	—	Use with Contractor Brooms.	12	44635

• Non-stock product, contact Customer Service for lead-times.



42383



44577



44578



44578



75555

P METAL HANDLES - Reinforced, heavy-duty metal handles are available in two colors and optional foam cover.

Length	Diameter	Tip	Description	Std. Pack	Item No.
48"	3/4"	Threaded Plastic	Black metal with plastic hang cap.	12	42383
60"	15/16"	Threaded Metal	Black plastic coat with plastic hang cap.	12	44577
60"	15/16"	Threaded Metal	Black plastic coat with black foam cover and plastic hang cap.	12	44578

V VORTEC PRO® METAL HANDLES - Reliable and efficient handles at a value price.

Length	Diameter	Tip	Description	Std. Pack	Item No.
60"	15/16"	Threaded Plastic	Black plastic coat with convenient hang-up cap.	12	75555

P

METAL TELESCOPING AND FOUNTAIN TUBE HANDLES - Use telescoping handles to shorten or extend the reach of the handle. Use fountain tube handles when a continuous flow of water is needed, i.e. car/truck washing.

Length	Diameter	Type	Use	Std. Pack	Item No.
6' extends to 12'	-	Telescoping	Window, wall and Vehicle wash brushes	6	44499
5'	7/8"	Fountain Tube	Vehicle wash brushes	12	44319



P

FIBERGLASS HANDLES - Fiberglass handles are stronger than wood or metal. Virtually indestructible.

Length	Diameter	Tip	Description	Std. Pack	Item No.
56-3/4"	1"	Tapered/Threaded	Hollow handle	12	44561*
54"	1"	Threaded	Honeycomb core	12	44562
60"	1"	Threaded	All white	12	44563+

* For use with both tapered and threaded holes + Approved for the food service industry

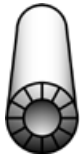

Fiberglass with polyethylene reinforced honeycomb core



Fiberglass hollow handle.

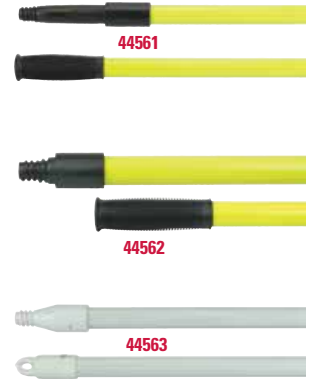

P

HANDLE ACCESSORIES

Description	Use	Std. Pack	Item No.
Steel brace. Fits all handle sizes.	Reinforces & locks handle to block. (Standard with sweeps 30" and larger)	12	44021
Heavy-duty steel brace attaches to block with wood screws and wraps around handle. Fits all handle sizes.	Increases life of the brush by providing extra support for handle and block.	12	44290
Replacement handle thread. Made of heavy-duty fiberglass. For any 15/16" diameter handle.	Cut off damaged threads and slip this tip in place for a new handle.	12	44317
Tapered Adapter to tapered ends.	Converts threaded handle ends	12	75505
Spring Loc Adapter for any 1-1/8" diameter tapered wood handle for street brooms and window brushes.	Keeps tapered wood handles from separating from the block.	6	44624

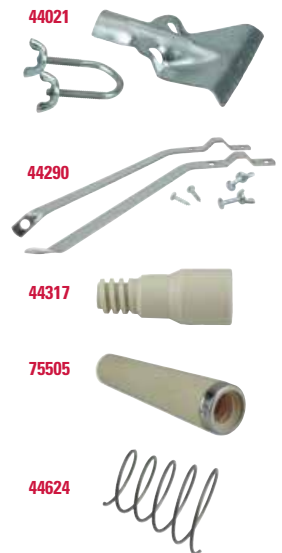

Key:

- P** Performance line Industrial Grade
- V** Value line Professional Grade

UPRIGHT AND WHISK BROOMS

Made of fine quality broom corn, fiber or synthetic material, Weiler's upright brooms and whisks are durable enough to meet all industrial and commercial applications.



Sweeping plastic and metal chips in a tool room

P UPRIGHT BROOMS - Ideal for sweeping floors, reaching into corners, cleaning ceilings, etc.



44009

Description	Fill Material	Trim Length	Overall Length	Standard Pack	Item Number
Household Broom - Good Quality					
4 sews - 7/8" handle	Corn & Fiber	15"	54"	12	44547
Light Industrial Brooms - Better Quality					
5 sews - 7/8" handle	Corn & Fiber	17"	57"	12	44548
5 sews - 7/8" handle	100% Corn	15"	56"	12	44009
6 sews - 1-1/8" handle	100% Black Corn	16"	56"	12	70304
Janitor's Broom - Best Quality					
5 sews - 1-1/8" handle Wire banded	Corn & Fiber	17"	57"	12	70308
Warehouse Broom - Heavy-Duty					
4 sews - 1-1/8" handle Wire banded	Corn & Fiber	18"	57"	12	44008



44305

P ANGLE BROOM - Angled trim allows access to corners, under low cabinets and other hard-to-reach areas.

Description	Fill Material	Trim Length	Overall Length	Standard Pack	Item Number
Large Plastic 12" sweep face	Flagged Plastic	7-1/2"-6"	54"	12	44305

V VORTEC PRO® ANGLE BROOM - Reliable and efficient broom at a value price.

Description	Fill Material	Trim Length	Overall Length	Standard Pack	Item Number
Small Plastic 8" sweep face	Flagged Plastic	3-7/8"-4-1/2"	54"	12	75160



70325

P CAP BROOMS - Metal top for added durability. Ideal for wet or dry applications.

Description	Fill Material	Trim Length	Overall Length	Standard Pack	Item Number
Metal Cap - Wire banded 12" sweep face	Palmyra	10"	55"	6	44007
Metal Cap - Wire banded 12" sweep face	Brown Poly	10"	55"	6	70325
Track & Switch Steel chisel point on handle end	Palmyra	8"	55"	6	70324



70300

V VORTEC PRO LOBBY BROOMS - Reliable and efficient brooms at a value price.

Description	Fill Material	Trim Length	Overall Length	Standard Pack	Item Number
Plastic Cap - 8" sweep face	Flagged Plastic	5"	36"	12	44546 •
Toy/Lobby - 3 sews, 7/8" handle	Corn & Fiber	11"	40"	12	70300

• Non-stock product, contact Customer Service for lead-times.



44266

P WHISK BROOMS - For fast, efficient clean-up.

Use	No. of Sews	Fill Material	Trim Length	Overall Length	Std. Pack	Item No.
General purpose - all applications	3	Corn & Fiber	10"	12-1/2"	12	44266
Sweeping coarse & heavy material	2	Palmetto	7"	9-1/4"	12	44099
Coarse sweeping of hot chips	-	Bassine	5-1/4"	10-1/4"	12	44103

DUSTERS AND DUST PANS

Whether cleaning fine particles or heavy debris, Weiler has a Counter Duster to do the job. These brushes are available in a wide selection of fill materials and have comfortably shaped blocks in wood or foam. Also choose from an array of Dust Pans to meet the application requirements.



Cleaning up oil absorbent from a shop floor.

P COUNTER DUSTERS - For clean up in hard-to-reach areas.

Fill Material	Trim Length	Brush Length	Overall Length	Block Type	Std. Pack	Item No.
Horsehair						
Horsehair	2-1/4"	8"	13-1/4"	Wood	12	44003
	2-1/4"	9"	14-1/4"			44351
Black Horsehair and Fiber Mix	2-1/2"	8"	13-1/2"	Wood	12	71019
Synthetic						
Flagged Silver Polystyrene	2-1/2"	8"	13-1/4"	Wood	12	44354
Black Polystyrene	2-1/2"	8"	13-1/4"	Wood	12	25252
Orange Polystyrene	2"	9"	14"	Foam	12	42213
Natural Fiber						
Black Tampico	2-1/2"	8"	13-1/4"	Wood	12	25251
Tri-colored Tampico	2-1/2"	8"	13-1/2"	Wood	12	44004



44003



42213



44004

P DUST PANS - Durable, industrial grade - For quick clean-ups.

Description	Height	Width	Depth	Std. Pack	Item No.
Heavy-duty 20 gauge steel Black enamel finish	-	12"	13-1/2"	12	71078
Extra wide - Heavy-duty 20 gauge steel; Black enamel finish	-	16"	15"	12	71079
Lobby Dust Pan - Black enamel metal hopper; Aluminum handle	39-1/2"	12"	9"	6	71081 •

• Non-stock product, contact Customer Service for lead-times.



71078

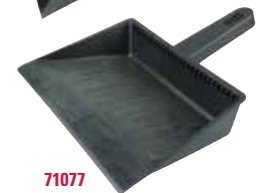

71077

V VORTEC PRO® DUST PANS - Reliable and efficient pans at a value price.

Description	Height	Width	Depth	Std. Pack	Item No.
Molded plastic	-	12-1/4"	12"	12	71077
Lobby Dust Pan Molded plastic hopper Aluminum handle	39-1/2"	12"	11"	6	71080



71080

Key:

P Performance line
Industrial Grade

V Value line
Professional Grade

COATED ABRASIVES

NON-WOVEN ABRASIVES

POWER BRUSHES

NYLON BRUSHES

PACKAGED ITEMS

MAINTENANCE

SQUEEGEES & WINDOW BRUSHES

Squeegees deliver fast, efficient cleaning. Weiler provides a variety of non-scratching floor and window squeegees and window brushes. Designed for high durability.



Cleaning a window with a window squeegee.



45507



45510



45500

P FLOOR SQUEEGEES - Heavy-duty construction, iron handle socket.

Description	Length	Type	Standard Pack	Item Number
Black rubber blade for rough, heavy use	18"	Straight	6	45506
	24"			45507
	30"			45534
	36"			75202
Black rubber blade for rough, heavy use	24"	Curved	6	45510
	30"			45535
	36"			45511

P WINDOW SQUEEGEES - Rust-proof handle socket and frame.

Description	Length	Standard Pack	Item Number
One piece frame with hard rubber section joined with a soft, red rubber blade.	6"	12	45537
	12"		45500
	14"		45538 •

• Non-stock product, contact Customer Service for lead-times.

NOTE



- All squeegees require a tapered tip handle.
- Handle No. 44020 (1-1/8" x 60") recommended for use with all Squeegees.
- Use Spring-Loc Adapter to keep tapered wood handle securely fastened to the block.
- Handle not included in price - order handle separately. See pages 150-151 for adapter and handle.



25271

V ROUND STYLE WINDOW BRUSH - Two threaded handle holes High quality, non-scratching brushes used for industrial window washing.

Description	Block Size	Block	Trim Length	Standard Pack	Item Number
Flagged Gold Polystyrene	4-1/2"	Plastic	2-1/2"	12	25271

NOTE



- Handle No. 44019 (1-1/8" x 60") recommended for use with #25271 & #73003 Window Brushes.
- Handle not included in price - order handle separately. See page 150 for handle.

Key:

P Performance line
Industrial Grade

V Value line
Professional Grade

VEHICLE CARE PRODUCTS

Weiler's line of vehicle care brushes meets the cleaning needs of car and truck fleets. Brushes are also popular in the marine industry. All products are designed to provide professional results.



Washing a car with a vehicle wash brush and fountain tube handle.

P VEHICLE WASH BRUSHES - Protective bumper - Foam block with two handle holes. Can be used with flow-through handle #44319 on page 147.

Block Size	Fill Material	Trim Length	Standard Pack	Item Number	★ Combo Qty. Item Number
9-1/2" x 2-3/4"	Grey Fiber	2-1/2"	12	44318*	—
9-1/2" x 2-3/4"	Flagged White Polystyrene	2-1/2"	12	44510	44875 •
9-1/2" x 2-3/4"	Flagged Orange Polystyrene	2-1/2"	12	42210	—
9-1/2" x 2-3/4"	Flagged Green Polystyrene	2-1/2"	12	73146	—

* May scratch smooth or high gloss surfaces, use polystyrene filled products for these surfaces.

• Non-stock product, contact Customer Service for lead-times.

★ Combo Packs include 12 brushes per pack and 12 #44319 handles (not assembled).



44510

P SCHOOL BUS BRUSH - Easily sweeps between school bus seats. Lacquered hardwood block with one threaded handle hole. Use handle #44571 on page 146.

Block Size	Fill Material	Trim Length	Standard Pack	Item Number
10" x 2-1/2"	Flagged Silver-grey Polystyrene	3"	12	70312



70312

P UPHOLSTERY/SPOTTING BRUSH - Shaped plastic handle
Wet & dry cleaning, prespotting, carpet touch-up, etc.

Block Size	Fill Material	Trim Length	Overall Length	No. of Rows	Std. Pack	Item Number
8-1/2" x 2-9/16"	.016 Crimped Polypropylene	5/8"	8-1/2"	8 x 9	12	44307



44307

P SPOKE BRUSH - Ideal for cleaning spokes or confined spaces.

Length of Brush Part	Fill Material	Brush Part	Overall Length	Standard Pack	Item Number
10"	White Tampico	2-7/8" tapered to 1-1/4"	15"	12	44315



44315

P TIRE CLEANING BRUSHES - Foam block - Used for cleaning sidewalls of tires.

Block Size	Fill Material	Trim Length	Overall Length	No. of Rows	Std. Pack	Item No.
8-1/2" x 2-9/16"	.008 Brass	5/8"	8-1/2"	8 x 9	12	99593
7" x 1-9/16"	.008 Brass	5/8"	7"	6 x 8	12	73156



99593

COATED ABRASIVES

NON-WOVEN ABRASIVES

POWER BRUSHES

NYLON BRUSHES

PACKAGED ITEMS

MAINTENANCE

SCRUB BRUSHES



Scrubbing a stainless steel sink.

A broad range of high quality scrub and utility brushes are available from Weiler. From quick cleaning to heavy-duty scrubbing, Weiler's brushes are designed to provide the most effective brushing and cleaning action.

P HAND SCRUB BRUSHES - Heavily filled for heavy-duty scrubbing.

Block Size	Fill Material	Trim Length	Block Type	Standard Pack	Item Number
6"	White Polypropylene	1-1/8"	Iron Style - Plastic	12	44395
7-1/4"	Palmyra	1"	Square - Wood	24	72034 •
8"	White Tampico	1-1/8"	Square - Wood	12	44024
	White Tampico Palmyra	1" 1-1/8"			72058* 44025
8-1/4"	White Tampico	1-1/8"	Square - Wood	12	73111+
9"	White Tampico	1-1/8"	Pointed - Wood	12	44023

* Threaded handle hole

+ Tapered handle hole

• Non-stock product, contact Customer Service for lead-times.

P DECK SCRUB BRUSHES - Excellent for scrubbing decks or floors. One threaded and one tapered handle hole. Can be used with threaded handle #44018 or tapered handle #44020 on page 150.

Block Size	Fill Material	Trim Length	No. of Rows	Block Type	Standard Pack	Item Number
9"	Palmyra	2"	5 x 14	Wood	12	44428
	Tampico					44429
10"	Palmyra	2"	6 x 18	Wood	12	44026
	Tampico					44028
	Polypropylene					44434
12"	Palmyra	2"	6 x 20	Wood	12	44027
	Tampico					44029 •
	Polypropylene					44438

• Non-stock product, contact Customer Service for lead-times.

P BI-LEVEL SCRUB BRUSHES - The bi-level design allows the brush to stay in contact with the surface. Can be used with flow-through handle #44319 on page 147 or the Perma-Flex handle #44301 on page 150.

Block Size	Fill Material	Trim Length	Block Type	Standard Pack	Item Number
10"	Stiff Crimped Blue Polypropylene	1-3/4"	Foam	6	44692
10"	Flagged White Polystyrene	2-3/4"	Foam	6	44699
10"	Fine Green Nylex	2-3/4"	Foam	12	44693

V VORTEC PRO® BOOT BRUSH - Reliable and efficient brush at a value price.

Size	Description	Item Number
9" x 6"	Boot Cleaning Brush - Metal Frame - Wood Block - Black Nylon Fill	44391



44395



44024



44023



44026



44434



44692



44391

SCRUB BRUSHES & UTILITY BRUSHES



Removing stubborn dirt, grime and mildew from a tiled surface with a grout detail brush.

P **UTILITY SCRUB BRUSHES** - For general scrubbing in factories, kitchens, institutions, etc.

Overall Length	Fill Material	Trim Length	Block Type	Standard Pack	Item Number
8"	Palmyra	2"	Wood	12	72086
	Yellow Polypropylene				44013
	White Tampico				44014
20"	Palmyra	2"	Wood	12	72101
	Yellow Polypropylene				44016
	White Tampico				44017

P **UTILITY SCRUB BRUSHES** - Chemical and water resistant, will not warp or crack.

Overall Length	Fill Material	Trim Length	Block Type	Standard Pack	Item Number
8"	Palmyra	2"	Foam	12	79101
	Yellow Polypropylene				79120
	White Tampico				79100
20"	Palmyra	2"	Foam	12	79107
	Yellow Polypropylene				79109
	White Tampico				44663

P **UTILITY SCRUB BRUSHES** - Designed for high temperature cleaning, ideal for food service.

Overall Length	Fill Material	Trim Length	Block Type	Standard Pack	Item Number
8"	White Nylon	2"	Plastic	12	44416
20"	White Nylon	2"	Plastic	12	44418

V **VORTEC PRO® UTILITY SCRUB BRUSHES** - Ideal for general purpose cleaning.

Overall Length	Fill Material	Trim Length	Block Type	Standard Pack	Item Number
8"	Tampico	2"	Foam	12	25262
20"	Tampico	2"	Foam	12	25263

P **GROUT DETAIL BRUSH** - Use for removing stubborn dirt, grime and mildew from tiled surfaces.

Block Size	Fill Material	Trim Length	Standard Pack	Item Number
8-1/2"	Stiff Black Nylon	7/8"	24	73233

P **BOWL BRUSH** - 2" Trim Length - For thorough, efficient cleaning.

Brush Part	Fill Material	Handle	Overall Length	Standard Pack	Item Number
5-3/4" x 4-3/4"	Black Nylon	Plastic	21"	12	75068



44014



44016



79120



79107



44418



25262



73233



75068

COATED ABRASIVES

NON-WOVEN ABRASIVES

POWER BRUSHES

NYLON BRUSHES

PACKAGED ITEMS

MAINTENANCE

Key:

P Performance line
Industrial Grade

V Value line
Professional Grade



44001

P **PROFESSIONAL BOWL BRUSHES** - Hardwood handle and natural fiber - For thorough cleaning.

Brush Part	Fill Material	Diameter	Overall Length	Standard Pack	Item Number
6" x 5"	White Tampico	2"	20"	12	44001*
6-1/2"	Tampico	3-1/4"	23"	12	75060

* Foam handle



75000

V **VORTEC PRO® BOWL BRUSH SET** - 2" Trim Length - Reliable and efficient brushes at a value price.

Brush Part	Fill Material	Handle	Overall Length	Standard Pack	Item Number
3-1/2" x 3-3/4"	Polypropylene	Plastic	14-1/2"	6	75000



44314

V **VORTEC PRO NAIL BRUSH** - Great for use in shop or industrial settings.

Block Size	Fill Material	Trim Length	No. of Rows	Block Type	Standard Pack	Item Number
4-3/4" x 1-1/2"	Polypropylene	3/4"	4 x 15	Wood	36	44314



99594

P **BOTTLE WASHING BRUSH** - Brush shape enables access to hard-to-reach areas when cleaning.

Length of Brush Part	Fill Material	Handle	Overall Length	Standard Pack	Item Number
6"	Black Horsehair	Wood	16"	12	99594



75085

V **VORTEC PRO BOTTLE WASHING BRUSH** - Reliable and efficient brush at a value price.

Length of Brush Part	Fill Material	Handle	Overall Length	Standard Pack	Item Number
5-1/2" x 2-3/8"	White Nylon	Twisted-in-wire	17"	24	75085



44111



44115

P **NYLON TUBE BRUSHES** - Loop handle, Straight black nylon fill.

Diameter	Fill Diameter	Brush Part	Stem Diameter	Overall Length	Standard Pack	Item Number
1/4"	.005	2"	3/32"	6-1/4"	36	44110
3/8"	.005	2"	3/32"	6-1/4"	36	44213
1/2"	.010	3"	1/8"	8-1/2"	36	44111
3/4"	.012	3"	1/8"	8-1/2"	36	44112
1"	.014	4"	5/32"	12-1/4"	36	44113
1-1/4"	.014	4"	5/32"	13"	36	44114
2"	.014	5"	3/16"	16-3/4"	36	44115



44316

P **PERCOLATOR BRUSH** - Straight white nylon fill
Ideal for internal cleaning in industrial, laboratory and food service.

Diameter	Fill Diameter	Brush Part	Stem Diameter	Overall Length	Standard Pack	Item Number
7/16"	.010	3-1/2"	5/32"	11-1/2"	10	44316



75570

P **VAT BRUSH** - For valves, outlets, small tanks, beverage dispensers & coffee urns.
Can be used with the Perma-Flex handle #44301 on page 150.

Fill Material	Block Type	Overall Length	Standard Pack	Item Number
White Nylon	White Nylon	8"	1	75570

WET MOPS & ACCESSORIES

Our wet mops are made with industrial grade cotton and can be laundered. They will not scratch floors or unravel.



Use the Combo Bucket with 12 to 32 oz. mop heads

P **WET MOP HEADS** - Durable, ideal for all-purpose cleaning. Can be laundered.

Weight	Material	Standard Pack	Item Number
Cut End			
16 oz.	8-ply tight twist cotton	12	75102
20 oz.			75103
24 oz.			75104
32 oz.			75105
Small	4-ply high bulk cotton economy	12	75170 •
Medium			75171
Large			75172
X-Large			75173 •
Loop End			
Small	4-ply tight twist cotton	12	75180 •
Medium			75181
Large			75182 •

• Non-stock product, contact Customer Service for lead-times.



75102



75171

COATED ABRASIVES

NON-WOVEN ABRASIVES

POWER BRUSHES

NYLON BRUSHES

PACKAGED ITEMS

MAINTENANCE

P **WET MOP HANDLES** - Industrial Grade. Hardwood handle with plated metal heads.

Description	Size	Standard Pack	Item Number
Quick-Change Plastic Head	54" x 15/16"	12	75140
Screw Type	54" x 1-1/8"	12	75131
Spring Type	54" x 1-1/8"	12	75132
Jaw Type	54" x 1-1/8"	12	75130



75140

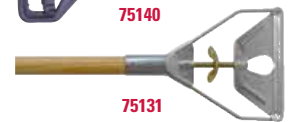

75131

P **ONE-PIECE COTTON DECK MOPS** - Industrial grade. Mop head securely tied to handle.

Description	Weight	Standard Pack	Item Number
#10	10 oz.	12	75096 •
#12	12 oz.	12	75097 •
#16	16 oz.	12	75109
#20	20 oz.	12	75098
#24	24 oz.	12	75110

• Non-stock product, contact Customer Service for lead-times.



75109

V **VORTEC PRO® COMBO BUCKET** - One-piece construction that will not rust, fade, crack, peel, chip, dent or warp. Wringer fits all sizes of plastic or metal buckets.

Bucket Size	Wringer	Standard Pack	Item Number
36 qt.	12-32 oz.	1	36666



36666

Key:



Performance line
Industrial Grade



Value line
Professional Grade

DUST MOPS & DUSTING BRUSHES

Our dust mops are made with industrial grade cotton and can be laundered. They will not scratch floors or unravel.



Cleaning a corner with a dust mop.



75117

P **PROFESSIONAL DUST MOPS** - Tie-on style, 4-ply cotton. Can be laundered.

Mop Size	Frame Size	Standard Pack	Item Number
24"	5" x 24"	12	75117
36"	5" x 36"	12	75118



75138

P **PROFESSIONAL DUST MOP FRAMES** - Heavy-duty full swivel frame.

Mop Size	Frame Size	Standard Pack	Item Number
24"	5" x 24"	12	75137
36"	5" x 36"	12	75138



75133

P **PROFESSIONAL DUST MOP HANDLE** - Heavy-duty clamp-on style.

Length	Diameter	Standard Pack	Item Number
60"	15/16"	12	75133



73050

P **RADIATOR BRUSHES** - 24" Overall Length. Ideal for cleaning radiators and narrow, hard-to-reach places.

Fill Material	Type	Brush Part	Trim Length	Overall Length	Std. Pack	Item No.
Black Horsehair	Foam Handle	9-1/2"	2-1/2"	23-13/16"	12	73050
Black Horsehair	Twisted-in-wire handle	7-1/2"	2-1/2"	24-11/16"	12	73055



73055



71076

P **WALL DUSTING BRUSH** - For dusting ceilings, valances, high moldings and other hard-to-reach places. Twisted-in-wire construction with plastic handle.

Fill Material	Overall Length	Trim Length	Standard Pack	Item Number
Horsehair	12" x 5"	2-3/4"	2	71076

MASONRY & APPLICATOR BRUSHES

Weiler's full line of Masonry & Applicator Brushes covers everything from the ground up - cement finishing and stippling brushes for texturing and applying cement and asphalt; whitewashing and masonry brushes for applying cement, water paints and liquid waterproofing materials on concrete block and masonry walls; smoothing brushes for applying wallpaper; and roof brushes for spreading roofing tar and coatings.



Applying waterproofing material with a masonry brush.

P **KNOT-TYPE ROOF BRUSHES** - For application of roof coatings. Can be used with tapered handle #44574 on page 150.

Block Size	Fill Material	Trim Length	No. of Knots	Standard Pack	Item Number	★ Combo Qty. Item Number
6-1/4"	Tampico	3-1/4"	3	12	44010	44883 •

★ Combo Packs include 12 brushes per pack and 12 #44574 handles (not assembled).

• Non-stock product, contact Customer Service for lead-times.



44010

P **BLOCK-TYPE ROOF BRUSHES** - For application of roof coatings. Can be used with tapered handle #44574 or threaded handle #75527 on page 150.

Block Size	Fill Material	Trim Length	No. of Knots	Standard Pack	Item Number	★ Combo Qty. Item Number
7"	White Tampico One tapered handle hole	2"	5	12	44011	44884 •
7"	White Tampico One threaded handle hole	2"	5	12	73195	—

★ Combo Packs include 12 brushes per pack and 12 #44574 handles (not assembled).

• Non-stock product, contact Customer Service for lead-times.



44011

P **MASONRY BRUSHES** -

Useful tools for applying cement, waterpaints and liquid waterproofing materials on masonry walls. Handle attached.

Block Size	Fill Material	Trim Length	Overall Length	No. of Rows	Standard Pack	Item Number
7"	White Tampico	3-1/4"	11"	2	12	44032
6"	Solvent Resistant Polypropylene	3-1/4"	11-1/2"	3	12	74020
4"	White Tampico	3"	10-3/4"	4	12	74004
6-1/2"	White Tampico	3-1/2"		4	12	44031
6"	White Tampico	3"	10-1/2"	5	12	74002
6-1/2"	White Tampico	4"	11-3/4"	5	12	44448



44031



44448

P **WHITWASH BRUSHES** - Two tapered handle holes allow user to choose the correct brush angle needed. Can be used with tapered handle #75528 on page 150.

Block Size	Fill Material	Trim Length	No. of Rows	Standard Pack	Item Number
6"	White Tampico	2-5/8"	2	12	74048
7"	White Tampico	2-5/8"	2	12	44034
					74053*

* Includes a 12" tapered wood handle.



44034

Key:

P Performance line
Industrial Grade

V Value line
Professional Grade

COATED ABRASIVES
NON-WOVEN ABRASIVES
POWER BRUSHES
NYLON BRUSHES
PACKAGED ITEMS

MAINTENANCE



74015

P

ACID BRUSH - Detachable handle - For the application of Kalsomine, cold water, acid and water repellents to concrete and other rough surfaces.

Block Size	Fill Material	Trim Length	No. of Rows	Standard Pack	Item Number
7"	White Tampico	3-1/2"	3	12	74015



73111

P

ACID SCRUB BRUSH - Hardwood block - Tapered handle hole. Recommended for applying sealcoating, cement slurry, water-proofing, etc.

Block Size	Fill Material	Trim Length	Standard Pack	Item Number
8-1/4" x 2-3/4"	White Tampico	1-1/8"	12	73111

NOTE: Handle not included - can be used with tapered handle #44574 on page 152.



79251

P

CEMENT FINISHING BRUSHES - Hardwood block - Ideal for creating texture to newly poured cement and for applying coatings on asphalt or concrete. Use handle #44303 on page 150.

Block Length	Fill Material	Trim Length	No. of Knots	Standard Pack	Item Number	★ Combo Qty. Item Number
24"	Black Polypropylene	2-1/4"	3	6	79251	-
24"	Black Polypropylene	3-1/4"	3	6	79252	44879 •
36"	Black Polypropylene	3-1/4"	3	6	79253	44880 •
24"	Horsehair	2-1/2"	3	6	79255 •	44881 •
36"	Horsehair	2-1/2"	3	6	79256 •	44882 •

★ Combo Packs include 12 brushes per pack and 12 #44303 handles (not assembled).

• Non-stock product, contact Customer Service for lead-times.



74078

P

SMOOTHING BRUSH - Hardwood block - For smoothing wallpaper.

Block Length	Fill Material	Trim Length	Standard Pack	Item Number
12"	White Tampico	2"	12	74078

Creating texture on newly poured concrete with a cement finishing brush.



Key:

P Performance line
Industrial Grade

V Value line
Professional Grade

SCRATCH BRUSHES

Weiler's extensive Scratch Brush offering includes many block and handle types and sizes. The wide variety of fill materials available assures the right brush for the right job. Common applications are cleaning dirt, rust, scale, chips and paint; plating and welding operations.



Removing excess concrete from the surface of a steel support plate.

P CURVED HANDLE SCRATCH BRUSHES - **Hardwood block** - Ideal for cleaning and prepping surfaces.

Block Size	Brush Length	Number of Rows	Trim Length	Standard Pack	Item Number
.012 Steel Wire					
13-3/4" x 1-1/8"	5-1/4"	3 x 14	1-1/4"	12	44594*
14" x 7/8"	5-1/2"	3 x 19	1-3/16"	12	44053
14" x 1-1/8"	6"	4 x 18	1-3/16"	12	44056
.012 Steel Wire with Scraper					
14" x 7/8"	5-1/2"	3 x 19	1-3/16"	12	44055
14" x 1-1/8"	6"	4 x 18	1-3/16"	12	44058
.012 Stainless Steel Wire					
13-3/4" x 1-1/8"	5-1/4"	3 x 14	1-1/4"	12	44432*
14" x 7/8"	5-1/2"	3 x 19	1-3/16"	12	44054
14" x 1-1/8"	6"	4 x 18	1-3/16"	12	44057

* V-Groove



44594
Top View

44053

44055

25150

V VORTEC PRO® CURVED HANDLE SCRATCH BRUSHES -

Reliable and efficient brushes at a value price.

Block Size	Brush Length	Number of Rows	Trim Length	Standard Pack	Item Number
.012 Steel Wire					
13-1/2" x 1"	6"	3 x 19	1"	12	25150
14" x 1-1/8"	6"	4 x 18	1"	12	25201
.012 Stainless Steel Wire					
13-1/2" x 1"	6"	3 x 19	1"	12	25154
14" x 1-1/8"	6"	4 x 18	1"	12	25202

P SHOE HANDLE SCRATCH BRUSHES - **Hardwood block** - Ideal for cleaning and prepping surfaces.

Block Size	Brush Length	Number of Rows	Trim Length	Standard Pack	Item Number
.012 Steel Wire					
10" x 3/8"	5"	1 x 17	1-1/16"	12	44100
10" x 5/8"	5"	2 x 17	1-3/16"	12	44061
10" x 1-1/8"	5"	4 x 16	1-3/16"	12	44063
11"	5"	4 x 16	1-3/16"	12	73217 •
.012 Steel Wire with Scraper					
10" x 1-1/8"	5"	4 x 16	1-3/16"	12	44065
.012 Stainless Steel Wire					
10" x 3/8"	5"	1 x 17	1-1/16"	12	44101
10" x 3/8"	5"	1 x 17	3/4"	12	44235
10" x 5/8"	5"	2 x 17	1-3/16"	12	44062
10" x 1-1/8"	5"	4 x 16	1-3/16"	12	44064
11"	5"	4 x 16	1-3/16"	12	44299 •
.012 Brass Wire					
11"	5"	4 x 16	1-1/4"	12	73218 •

• Plastic block



44063

44065

73218

V VORTEC PRO SHOE HANDLE SCRATCH BRUSHES -

Reliable and efficient brushes at a value price.

Block Size	Brush Length	Number of Rows	Trim Length	Standard Pack	Item Number
.012 Steel Wire					
10" x 1"	5"	4 x 16	1"	12	25100
.012 Stainless Steel Wire					
10" x 1"	5"	4 x 16	1"	12	25104



25100

COATED ABRASIVES

NON-WOVEN ABRASIVES

POWER BRUSHES

NYLON BRUSHES

PACKAGED ITEMS

MAINTENANCE



P HEAVY-DUTY SCRATCH BRUSH WITH SCRAPER - .012 Steel Wire

Ideal for cleaning and prepping surfaces.

Block Size	Brush Length	Number of Rows	Trim Length	Standard Pack	Item Number
11-1/2" x 1-1/2"	5-1/2"	4 x 11	1-1/2"	12	44069

V VORTEC PRO® HEAVY-DUTY SCRATCH BRUSH WITH SCRAPER - .012 Steel Wire

Reliable and efficient brushes at a value price.

Block Size	Brush Length	Number of Rows	Trim Length	Standard Pack	Item Number
11-1/2" x 1-1/2"	5"	4 x 11	1-5/8"	12	25211



P PLATER'S BRUSHES - Hardwood block - For general cleaning in the plating, metal finishing, aircraft and missile industries. Also used with inert arc aluminum welding.

Block Size	Brush Length	Number of Rows	Trim Length	Standard Pack	Item Number
Tampico					
13" x 1-1/4"	5-1/4"	4 x 18	1"	12	44076
Nylon					
13" x 1-1/8"	5-1/4"	4 x 18	1"	12	44077
.006 Steel Wire					
10" x 1-1/8"	5"	4 x 16	1"	12	44117 •
13" x 7/8"	5-1/2"	3 x 19	1"	12	44116
.006 Stainless Steel Wire					
10" x 1-1/8"	5"	4 x 18	1"	12	44240
13" x 7/8"	5-1/2"	3 x 19	1"	12	44660
13" x 1-1/8"	5-1/2"	4 x 19	1"	12	44232
.006 Brass Wire					
10" x 1-1/8"	5"	4 x 18	1"	12	44119
13" x 7/8"	5-1/2"	3 x 19	1"	12	44118

• Non-stock product, contact Customer Service for lead-times.



P SMALL HAND SCRATCH BRUSHES - Ideal for cleaning and prepping surfaces.

Block Size	Block	Number of Rows	Wire Size	Trim Length	Standard Pack	Item Number
Stainless Steel Wire						
7-1/2" x 1/2"	Plastic	3 x 7	.006	1/2"	36	44075 ■
7-1/2" x 1/2"	Wood	3 x 7	.006	1/2"	36	44167 ■ +
7-3/4" x 3/8"	Wood	3 x 7	.006	1/2"	36	44551 *
8-3/4" x 1/2"	Wood	2 x 9	.006	5/8"	36	95013
Straight Brass Wire						
7-1/2" x 1/2"	Wood	3 x 7	.006	1/2"	36	44189 ■
Crimped Brass Wire						
6" x 1/2"	Wood	3 x 10	.005	5/8"	72	44619
8-3/4" x 1/2"	Wood	2 x 9	.008	5/8"	36	95014
Crimped Aluminum						
6-3/4" x 1-5/8"	Wood	6 x 9	.008	5/8"	12	95151
8-3/4" x 1/2"	Wood	2 x 9	.008	5/8"	36	44251
Straight Black Nylon						
6-1/2" x 1/2"	Plastic	4 x 15	.010	1/2"	24	99383
7-1/2" x 1/2"	Wood	3 x 7	.012	1/2"	36	44637 ■
White Nylon						
7-1/2" x 1/2"	Plastic	3 x 7	.016	1/2"	36	44609
Double-Sided Brass/White Nylon						
7-1/2" x 1/2"	Plastic	3 x 7	.006/.016	1/2"	24	44731
Double-Sided Brass/Stainless Steel						
7-1/2" x 1/2"	Plastic	3 x 7	.006/.006	1/2"	24	44732
Double-Sided Stainless Steel/White Nylon						
7-1/2" x 1/2"	Plastic	3 x 7	.006/.016	1/2"	24	44733

+Countertop display available. See page 135 for details. ■ Packaged product available. See pages 136-139 for details.

*Wire drawn



Key:

P Performance line
Industrial Grade

V Value line
Professional Grade

V **VORTEC PRO® SMALL HAND SCRATCH BRUSHES** - Reliable and efficient brushes at a value price.

Block Size	Handle	Number of Rows	Trim Length	Standard Pack	Item Number
.006 Stainless Steel Wire					
7-1/2" x 1/2"	Wood	3 x 7	1/2"	36	44805
7-1/2" x 1/2"	Plastic	3 x 7	1/2"	36	44806
.006 Straight Brass Wire					
7-1/2" x 1/2"	Wood	3 x 7	1/2"	36	44810



44806

P **BLOCK TYPE SCRATCH BRUSHES** - For rugged cleaning on bricks, stone and similar large flat areas.

Block Size	Fill Material	Brush Part	Number of Rows	Trim Length	Standard Pack	Item Number
7-1/4" x 2-5/8"	.012 Round Wire - Curved Face	7"	9 x 21	1-3/16"	12	44066
7-1/4" x 2-1/4"	.014 Round Wire - Flat Face	7"	6 x 19	1-5/8"	12	44067



44067

V **VORTEC PRO BLOCK TYPE SCRATCH BRUSH** - Reliable and efficient brushes at a value price.

Block Size	Fill Material	Brush Part	Number of Rows	Trim Length	Standard Pack	Item Number
7-1/4" x 2-1/4"	.012 Steel	7"	6 x 19	1-5/8"	12	25212

P **BUTCHER BLOCK BRUSH** - For cleaning concrete forms and green concrete after forms have been removed.

Block Size	Fill Material	Brush Part	Number of Rows	Trim Length	Standard Pack	Item Number
7-1/2" x 2-3/4"	.017 x .110 - Flat Wire	7"	5 x 10	1-1/4"	12	44073



44073

P **CHIPPING HAMMER REFILL** - A refill brush for most chipping hammers. Used for weld cleaning.

Block Size	Fill Material	Brush Part	Number of Rows	Trim Length	Standard Pack	Item Number
4-5/8" x 7/8"	.012 Steel	4-1/2"	3 x 15	1-1/8"	12	44070



44070

P **WIRE DUSTER** - For cleaning chips, borings, solder, rust, dirt & corrosion from castings.

Block Size	Fill Material	Handle Length	Number of Rows	Trim Length	Standard Pack	Item Number
3" x 1-1/8"	.012 Steel	5-3/4"	4 x 8	2-1/2"	12	44451



44451

P **FILE CARD BRUSH** - Waxed hardwood block. Use for file cleaning or to roughen and prepare surface material prior to sweating and soldering.

Overall Length	Fill Material	Brush Part	Trim Length	Standard Pack	Item Number
8-1/4"	.012 Steel	1-5/8" x 4"	1/4"	12	44260



44260

P **METAL CHIP BRUSH** - Small stiff wire brush for brushing hot metal. Can be exposed to flames without burning.

Overall Length	Fill Material	Trim Length	Face Width	Standard Pack	Item Number
5-1/2"	.012 Steel	1-1/2"	1-1/4"	12	44074



44074

FLUE BRUSHES



Cleaning boiler pipes with a flue brush.

Flue Brushes are designed and engineered from black oil-tempered wire. Flue brushes are available in single spiral and double spiral construction. Other fill materials and sizes available by special order. Contact Customer Service for details.

APPLICATIONS

Provides increased conformability and long life when:

- Pipe cleaning
- Flue cleaning
- Boiler tube cleaning

P **FLUE BRUSHES** - Filled with .012 round wire and fitted with 1/4" x 2" NPT pipe nipple. For internal cleaning of pipes and flues.



Brush Diameter	Brush Length	Overall Length	Standard Pack	Item Number
Single Spiral				
7/8"	4-1/2"	7-1/2"	1	44124 •
1"	4-1/2"	7-1/2"	1	44125
1-1/4"	4-1/2"	7-1/2"	1	44047
1-1/2"	4-1/2"	7-1/2"	1	44128
1-3/4"	4-1/2"	7-1/2"	1	44048
2"	4-1/2"	7-1/2"	1	44131
2-1/2"	4-1/2"	7-1/2"	1	44133
3"	4-1/2"	7-1/2"	1	44135
3-1/2"	4-1/2"	7-1/2"	1	44137
4"	4-1/2"	7-1/2"	1	44139
Double Spiral				
1"	4-1/2"	7-1/2"	1	44149
1-1/4"	4-1/2"	7-1/2"	1	44035
1-1/2"	4-1/2"	7-1/2"	1	44150
1-3/4"	4-1/2"	7-1/2"	1	44036
2"	4-1/2"	7-1/2"	1	44152
2-1/4"	4-1/2"	7-1/2"	1	44037
2-1/2"	4-1/2"	7-1/2"	1	44154
2-3/4"	4-1/2"	7-1/2"	1	44038
3"	4-1/2"	7-1/2"	1	44156
4"	4-1/2"	7-1/2"	1	44169
4-7/8"	4-1/2"	7-1/2"	1	44159

• Non-stock product, contact Customer Service for lead-times.



P **FLUE BRUSH EXTENSION ROD** - One 1/4" male pipe nipple and one 1/4" female pipe coupling allows user to extend flue brush.

Description	Standard Pack	Item Number
36" Fiberglass Extension Rod	1	95925

NOTE

"Pipeline" Flue Brushes By Special Order Only.

- Heavy-duty. Exact size diameter. Rugged double stem, single spiral.
- Fitted with 1/4" pipe nipple. Available in diameters of 1-5/8" - 15".

Key:

P Performance line
Industrial Grade

V Value line
Professional Grade

TUBE FITTING BRUSHES

Several configurations and sizes of Tube Fitting Brushes are available for cleaning and deburring copper, internal and external tube fittings. The handy 4-in-1 tube fitting brush cleans both outside and inside diameters of multiple tube sizes.



Cleaning the inside of a copper fitting prior to soldering.

P INTERNAL TUBE FITTING BRUSHES - Wire Fill - For internal cleaning and deburring of copper tube fittings. Also used in trucking and marine industries as a light socket cleaning brush.

Pipe Size	Actual Brush Diameter	Brush Length	Overall Length	Handle Length	Standard Pack	Item Number
1/8"	1/4"	1"	6-1/2"	3-1/4"	12	44078
1/4"	3/8"	1"	6-1/2"	3-1/4"	12	44079
3/8"	1/2"	1"	6-1/2"	3-1/4"	12	44080 ■
1/2"	5/8"	1"	6-1/2"	3-1/4"	12	44081
5/8"	3/4"	1"	6-1/2"	3-1/4"	12	44082
3/4"	7/8"	1"	6-1/2"	3-1/4"	12	44083
7/8"	1"	1"	6-1/2"	3-1/4"	12	44084
1"	1-1/8"	1"	6-1/2"	3-1/4"	12	44085
1-1/4"	1-3/8"	1"	6-1/2"	3-1/4"	12	44086
1-1/2"	1-5/8"	1-1/2"	6-1/2"	3-1/4"	6	44087

■ Packaged product available. See pages 136-139 for details.



44079

P EXTERNAL TUBE FITTING BRUSHES - 1/4" Stem

Ideal for cleaning tube ends. Mount to a hand drill for fast results.

Outside Diameter	Standard Pack	Item Number
3/8"	40	44734 •
1/2"	40	44735 •
5/8"	40	44736 •
3/4"	40	44737 •
7/8"	40	44738 •
1"	40	44739 •

• Non-stock product, contact Customer Service for lead-times.



44734

P 4-IN-1 TUBE FITTING BRUSH - ONE BRUSH REPLACES FOUR! - Steel Wire

Cleans the outside and inside diameters of 1/2" and 3/4" tubes and fittings. Use for soldering prep, deburring, drill hole cleaning and cleaning battery terminals.

Tube Inside Diameter	Tube Outside Diameter	Standard Pack	Item Number
3/4" and 1/2"	7/8" and 5/8"	1	44690



44690

TURBO TUBE™ BRUSHING TOOL - The Turbo Tube Brushing Tool is two brushes in one, so fittings and copper tubing can be easily cleaned without changing tools!

APPLICATIONS

- Fitting brush cleans outside diameter
- Tube brush cleans inside diameter
- Ideal for plumbing and HVAC projects

V VORTEC PRO® TURBO TUBE BRUSHES - Clean I.D. and O.D. with the same tool. Rust-proof stainless steel bristles. Reliable and efficient brushes at a value price.

I.D. Size	O.D. Size	Wire Type	Max. RPM	Standard Pack	Item Number
1/2"	5/8"	Stainless	1,000	1	36303
3/4"	7/8"				36304
1"	1-1/8"				36305



36303

COATED ABRASIVES

NON-WOVEN ABRASIVES

POWER BRUSHES

NYLON BRUSHES

PACKAGED ITEMS

MAINTENANCE

SELECTING THE RIGHT BRUSH

P PERFORMANCE LINE (INDUSTRIAL GRADE)

Engineered and manufactured to maximize performance and minimize operating costs. The use of superior construction, the highest quality materials and the most stringent manufacturing processes deliver the lowest cost-of-use and most consistent performance.

V VALUE LINE (PROFESSIONAL GRADE)

Weiler's value line is manufactured using similar product construction and the same exacting standards as other Weiler paint & varnish products, but engineered to provide cost-effective use specifically designed for the professional, providing a cost-effective price. Vortec Pro® paint & varnish products are an economical choice for the construction trades, low volume production shops and light-duty industrial MRO use.

SELECTION GUIDE

Brush Fill	Recommended For	Benefits
China Bristle	All oil based and alkyd paints, stains, varnish urethane & shellac	<ul style="list-style-type: none"> • Softest tip for fewest brush marks • Natural fibers hold paint better than synthetics
Polyester/Nylon blend	All paints and coatings	<ul style="list-style-type: none"> • Most durable material • Precise tipping • Cleans up easily
Polyester	All paints and coatings	<ul style="list-style-type: none"> • Low cost • Does not absorb water

PAINT BRUSH FEATURES

Fill Material:

- Natural China Bristle or Tapered Polyester
- Various sizes of fill material are blended together to create the proper taper.

Flagged Ends:

A split at the end of each tapered fiber of fill material. Bristle is naturally tapered with a flagged tip. Polyester fibers are made tapered and then mechanically processed to form a flagged tip. Flagging allows each tip to pick up more paint and spread it more evenly.

Thickness: The thickness of the brush, measured at the ferrule, will determine the quality level of the brush. The thicker the brush, the more paint pick-up and release.

Ferrule: The metal band that holds the fill material and handle together. All Weiler paint and varnish brushes are made with plated metal ferrules that will not rust or corrode.

Handle:

- Quality wood or synthetic
- Handles are sanded and lacquered
- Synthetic handles are not affected by paints, varnishes or solvents.
- Comfortable grip for hours of fatigue-free use.

Trim Length: The length of the fill material extending from the ferrule. The longer the trim, the more paint is picked up and released for a quicker, easier job.



PAINT BRUSH CARE

Brushes Used In	Clean With
<ul style="list-style-type: none"> • Oil base paint • Latex paint • Water base paint • Varnish • Shellac 	<ul style="list-style-type: none"> • Turpentine or mineral spirits • Warm soapy water • Warm soapy water • Turpentine or mineral spirits • Alcohol

Note: After cleaning, shake out, comb bristles and hang by handle.

SPECIAL PAINT BRUSHES

The brushes listed in this catalog will cover the major requirements of industry. However, if an application requires another type, size or style of brush, contact your nearest Weiler distributor or Weiler's Customer Experience Team.

PROFESSIONAL PAINT, VARNISH & SASH BRUSHES

These high quality brushes are available in a wide variety of sizes and materials to fill all applications. The Professional Wall Brushes have a sanded wooden handle, the preferred standard among professional users. The Professional Varnish and Sash Brushes are color coded - Blue for Bristle and Red for Polyester/Nylon Blend, and feature painted foam handles in the "beaver tail" style. These handles are attractive and easier to grip, reducing user fatigue.



Applying paint to clap board siding.

P WALL PAINT BRUSHES - For interior/exterior painting of large flat surfaces.

Width	Thickness	Bristle Length	Overall Length	Standard Pack	Item Number
Black China Bristle - Sanded Wood Handle					
3"	7/8"	3-1/4"	10-3/16"	6	40022
4"	7/8"	3-3/4"	11-1/2"	6	40023
Polystyrene/Nylon - Sanded Wood Handle					
3"	7/8"	3"	10-1/8"	6	40061
4"	7/8"	3"	11-1/4"	6	40062



40022



40061

P VARNISH BRUSHES - Comfortable foam grip handle; smooth paint flow.

Width	Thickness	Bristle Length	Overall Length	Standard Pack	Item Number
Black China Bristle - Blue Foam Handle					
1"	7/16"	2"	8-1/2"	12	40000
1-1/2"	1/2"	2-1/4"	8-7/8"	12	40001
2"	9/16"	3"	9-3/4"	12	40002
3"	11/16"	3"	10-1/8"	12	40004
4"	11/16"	3"	10-9/16"	12	40010
Polystyrene/Nylon - Red Foam Handle					
1"	7/16"	2-1/4"	8-13/16"	12	40058
2"	3/4"	2-3/4"	9-15/16"	12	40059
3"	7/8"	3"	10-1/8"	12	40060
4"	7/8"	3"	11"	6	40106



40002



40059

P ANGLED SASH BRUSHES - For trim or cut work like window sills, door frames, etc.

Width	Thickness	Bristle Length	Overall Length	Standard Pack	Item Number
Black China Bristle - Blue Foam Handle					
1-1/2"	7/16"	2-1/4"	10-7/8"	12	40041
2"	1/2"	2-1/4"	10-3/4"	12	40008
Polystyrene/Nylon - Red Foam Handle					
1-1/2"	7/16"	2-1/2"	11-1/4"	12	40011
2"	1/2"	2-1/2"	11-1/8"	12	40040



40041



40040

P FLAT SASH BRUSHES - For trim or cut work like window sills, door frames, or other narrow, flat surfaces.

Width	Thickness	Bristle Length	Overall Length	Standard Pack	Item Number
Black China Bristle - Blue Foam Handle					
1"	3/8"	2"	10-3/8"	12	40113
1-1/2"	7/16"	2-1/4"	10-1/2"	12	40114 •
2"	9/16"	3"	11-15/16"	12	40115
Polystyrene/Nylon - Red Foam Handle					
1"	3/8"	2-1/4"	10-1/4"	12	40014 •
1-1/2"	7/16"	2-1/4"	10-1/2"	12	40017
2"	9/16"	2-1/2"	10-15/16"	12	40018



40115



40017

• Non-stock product, contact Customer Service for lead-times.

COATED ABRASIVES

NON-WOVEN ABRASIVES

POWER BRUSHES

NYLON BRUSHES

PACKAGED ITEMS

MAINTENANCE

PROFESSIONAL SASH & PARTS CLEANING BRUSHES

These high quality brushes are available in a wide variety of sizes and materials to fill all applications. The Professional Sash Brushes are color coded - Blue for Bristle and Red for Polyester/Nylon Blend, and feature painted foam handles in the "beaver tail" style. These handles are attractive and easier to grip, reducing user fatigue. Parts cleaning brushes are ideal for applications such as cleaning carburetors, transmission components, applying adhesives and lubricants.

Cleaning an oil pan with a parts cleaning brush.

P OVAL SASH BRUSHES - Ideal for cleaning parts, crevices and painting hard-to-reach areas.



40056

Size	Thickness	Bristle Length	Overall Length	Standard Pack	Item Number
Black China Bristle - Plain Foam Handle - Chisel Trim					
#2	7/16"	1-3/4"	8-7/8"	24	40116
#4	11/16"	1-3/4"	8-5/8"	12	40019
#6	13/16"	1-3/4"	9-5/16"	12	40056
#8	15/16"	3"	11-1/8"	12	40020
#10	1-1/16"	3"	11-3/16"	12	40021

P ROUND SASH BRUSHES - Ideal for cleaning parts, crevices and painting hard-to-reach areas.



40121

Size	Thickness	Bristle Length	Overall Length	Standard Pack	Item Number
Grey Bristle - Plain Foam Handle - Flat Trim					
#2	7/16"	1-3/4"	8-3/4"	24	40118
#4	11/16"	2"	8-13/16"	12	40119
#6	13/16"	2"	10-1/16"	12	40120 •
#8	15/16"	2-1/4"	10-9/16"	12	40121
#10	1-1/16"	2-1/4"	10-9/16"	12	40122 •

• Non-stock product, contact Customer Service for lead-times.

P PARTS CLEANING BRUSHES - Stainless steel ferrule - Heavily filled.



40035

Thickness	Fill Material	Bristle Length	Overall Length	Standard Pack	Item Number
Plain Foam Handle - Chisel Trim					
1"	Polypropylene	2-1/2"	10-11/16"	12	40035
1"	Tampico	2-3/4"	11-1/8"	12	40036

V VORTEC PRO® PARTS CLEANING BRUSHES - Reliable and efficient brushes at a value price.



25222

Thickness	Fill Material	Bristle Length	Overall Length	Standard Pack	Item Number
Plain Foam Handle - Chisel Trim					
15/16"	Nylon	2-1/2"	11-3/16"	12	25221
1"	Tampico	2-3/4"	11-3/8"	12	25222

INDUSTRIAL PAINT BRUSHES

The Industrial paint brush line features color coded plastic handles to provide quality paint brushes at competitive prices.



Painting inside the fins of a radiator with a Radiator brush.

P INDUSTRIAL VARNISH BRUSHES - Heavily-filled brush with comfortable handle in a variety of sizes.

Width	Thickness	Bristle Length	Overall Length	Standard Pack	Item Number
Black Bristle - Black Plastic Handle					
1"	3/8"	1-3/4"	7-3/4"	36	40089
1-1/2"	7/16"	2"	8-5/16"	24	40101
2"	7/16"	1-3/4"	8"	12	40074
3"	1/2"	2"	8-13/16"	12	40103
4"	5/8"	2-3/4"	9-7/8"	12	40104
Black Polyester - Red Plastic Handle					
1"	3/8"	2"	8"	36	40107
1-1/2"	7/16"	2"	7-11/16"	24	40108
2"	7/16"	2"	8-1/2"	12	40109
3"	1/2"	2"	9-1/4"	12	40110
4"	11/16"	2-3/4"	9-7/8"	12	40111



40074



40109



95502

P BENT RADIATOR BRUSH - Ideal for painting radiators and other hard-to-reach areas.

Width	Thickness	Bristle Length	Overall Length	Standard Pack	Item Number
Black Bristle - Wood Handle					
2"	9/16"	2-1/4"	19-1/2"	12	95502

V VORTEC PRO® FOAM APPLICATOR BRUSHES - Reliable and efficient brushes at a value price.

Not recommended for use with lacquer, shellac or solvents.

Width	Thickness	Foam Length	Overall Length	Standard Pack	Item Number
Wood Handle					
1"	5/8"	2-5/8"	6-3/8"	50	99801
2"	5/8"	2-5/8"	6-1/2"	50	99805
3"	7/16"	2-5/8"	6-1/2"	40	99806



99806

Key:

P Performance line
Industrial Grade

V Value line
Professional Grade

COATED ABRASIVES

NON-WOVEN ABRASIVES

POWER BRUSHES

NYLON BRUSHES

PACKAGED ITEMS

MAINTENANCE

CHIP AND OIL BRUSHES



Removing chips from the ways of a lathe.

Chip and Oil brushes are inexpensive, multi-purpose brushes for use in applications requiring disposable brushes.

P CHIP AND OIL BRUSHES

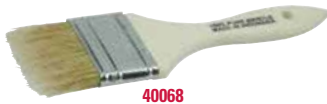

40068

Width	Thickness	Bristle Length	Overall Length	Standard Pack	Item Number
White Bristle - Wood Handle					
1/2"	5/16"	1-1/2"	7-3/16"	30	40065
1"	5/16"	1-1/2"	7"	30	40066
1-1/2"	5/16"	1-1/2"	7-7/8"	30	40067
2"	5/16"	1-1/2"	7-5/8"	20	40068
2-1/2"	3/8"	1-1/2"	7-3/4"	20	40069
3"	3/8"	1-1/2"	7-7/8"	10	40070
4"	5/8"	1-5/8"	8-9/16"	10	40071
	3/8"	2"	8-7/8"		40076

V VORTEC PRO® CHIP AND OIL BRUSHES - Reliable and efficient brushes at a value price.



40181



40161



40029



40141

Width	Thickness	Bristle Length	Overall Length	Standard Pack	Item Number
White Bristle - Wood Handle					
1/2"	5/16"	1-1/2"	7-3/16"	36	40177
1"	5/16"	1-1/2"	7-3/16"	36	40179
1-1/2"	5/16"	1-1/2"	7-1/16"	24	40180
2"	5/16"	1-1/2"	7-5/8"	24	40181
2-1/2"	3/8"	1-1/2"	7-15/16"	12	40182
3"	3/8"	1-1/2"	8-1/4"	12	40183
4"	5/8"	1-3/4"	8-3/4"	12	40184
4"	3/8"	1-3/4"	8-1/2"	12	40185
Black Bristle - Plastic Handle					
1/2"	1/4"	1-5/8"	7-1/8"	30	40160
1"	5/16"	1-5/8"	7-5/16"	30	40161
1-1/2"	5/16"	1-5/8"	7-3/8"	30	40162
2"	5/16"	1-5/8"	7-3/4"	20	40163
2-1/2"	3/8"	1-3/4"	7-3/4"	20	40164
3"	3/8"	1-3/4"	7-15/16"	10	40165
4"	11/16"	2"	8-1/2"	10	40166
Grey China Bristle - Plastic Handle					
1/2"	1/4"	1-1/2"	7-1/8"	48	40026
1"	5/16"	1-1/2"	7-5/8"	36	40027
1-1/2"	5/16"	1-1/2"	7-5/8"	24	40028
2"	3/8"	1-1/2"	7-7/8"	24	40029
2-1/2"	1/2"	1-1/2"	8-5/16"	12	40030
3"	1/2"	1-1/2"	8-9/16"	12	40031
4"	11/16"	1-1/2"	8-13/16"	12	40032
Black Polypropylene - Red Plastic Handle					
1"	5/16"	1-3/4"	7-9/16"	36	40137
2"	3/8"	1-3/4"	7-15/16"	24	40139
3"	1/2"	1-3/4"	9-3/16"	12	40140
4"	11/16"	2-3/4"	9-5/8"	12	40141

Key:

P Performance line
Industrial Grade

V Value line
Professional Grade

MARKING BRUSHES

Weiler's high quality Marking Brushes come in a variety of animal, natural and synthetic bristles in numerous handle styles for many applications such as fine artwork, pin striping and sign painting.



Painting a tight area on a steel door with a Marking Brush.

P RED SABLE WATERCOLOR BRUSHES - Seamless ferrule. Pointed tip - Round black handle

Size	Diameter	Trim Length	Overall Length	Standard Pack	Item Number
3/0	3/64"	1/4"	7"	12	41000
0	1/16"	5/16"	7-1/4"	12	41001
2	3/32"	7/16"	7-3/8"	12	41002
4	1/8"	5/8"	7-5/8"	12	41003



P BLACK BRISTLE MARKING BRUSHES - Long, lacquered handle

Size	Diameter	Trim Length	Overall Length	Standard Pack	Item Number
1	1/8"	3/4"	11-7/8"	12	41004
2	5/32"	15/16"	12"	12	41005
4	7/32"	1-1/8"	12-1/2"	12	41007
5	1/4"	1-1/4"	12-1/2"	12	41008
6	9/32"	1-3/8"	12-3/4"	12	41009



P FLAT MARKING BRUSHES - Ox hair - Single stroke - Round black handle

Width	Trim Length	Overall Length	Standard Pack	Item Number
1/4"	7/8"	7-7/8"	12	41018
1/2"	1"	8-3/4"	12	41019
3/4"	1-1/4"	8-3/4"	12	41020
1"	1-3/8"	9-3/8"	12	41021



P FITCH BRUSHES - Black china bristle - Chiseled edge - Clear lacquered handle

Width	Trim Length	Overall Length	Standard Pack	Item Number
1/4"	13/16"	12"	12	41022
1/2"	1-1/16"	12-3/8"	12	41023
3/4"	1-5/16"	12-7/8"	12	41024 •
1"	1-9/16"	13"	12	41025 •



• Non-stock product, contact Customer Service for lead-times.

P LACQUERING BRUSHES - Seamless aluminum ferrule - Camel hair - Round black handle

Size	Diameter	Trim Length	Overall Length	Standard Pack	Item Number
1	5/32"	11/16"	7-1/2"	12	41010
3	7/32"	13/16"	8"	12	41011
5	1/4"	1-1/8"	8-3/4"	12	41012 •
6	5/16"	1-3/16"	8-7/8"	12	41013 •



• Non-stock product, contact Customer Service for lead-times.

COATED ABRASIVES

NON-WOVEN ABRASIVES

POWER BRUSHES

NYLON BRUSHES

PACKAGED ITEMS

MAINTENANCE

GLUE AND ACID BRUSHES

Weiler's Glue and Acid Brushes come in multiple sizes, ferrule types, handles and fill materials for a wide variety of cleaning and coating applications.



Applying flux to a copper tube prior to soldering.



40078

P BRIDLED GLUE BRUSHES - Grey china bristle - Steel ferrule - Long foam handle

Diameter	Trim Length	Overall Length	Standard Pack	Item Number
7/16"	1-7/16"	8-1/4"	36	40077
13/16"	1-3/4"	9-3/8"	24	40078 •

• Non-stock product, contact Customer Service for lead-times.



44089

P ACID/FLUX BRUSHES - Horsehair - Tin ferrule

Width	Trim Length	Overall Length	Standard Pack	Item Number
5/16"	3/4"	5-3/4"	144	44088 ■
3/8"	3/4"	5-3/4"	144	44089 ■
1/2"	3/4"	5-3/4"	144	44090 ■

■ Packaged product available. See pages 136-139 for details.



44097

P STYLUS BRUSH - Stiff grey horsehair - Aluminum tube with cork to hold cleaning fluid. For cleaning electrical contact points.

Width	Trim Length	Overall Length	Standard Pack	Item Number
1/2"	3/8"	5"	100	44097



40082

P STENCIL BRUSHES - China bristle - Seamless steel ferrule - Lacquered wood handle

Diameter	Bristle Length	Overall Length	Standard Pack	Item Number
1"	1-3/8"	5-1/2"	12	40080
2"	1-3/4"	6-3/8"	12	40082



44262

P DOPE BRUSHES - With hanger for coating applications in drilling operations.

Brush Part	Fill Material	Diameter	Overall Length	Standard Pack	Item Number
4"	Mixed	2"	16"	24	44261
	Tampico	2-1/2"		24	44262
		3"		6	44263

Key:

P Performance line
Industrial Grade

V Value line
Professional Grade

PAINT ROLLERS AND ACCESSORIES

Paint Rollers can be used almost anywhere including walls, ceilings, floors, decks, fences, metal surfaces, concrete, and brick walls. Weiler carries a wide variety of rollers for the professional painter, industrial use and those weekend DIY projects.

PAINT ROLLER SELECTION GUIDE

Work Surface	Coating	Recommended Nap
Metal, Smooth Wood, Smooth Concrete	Enamels, Epoxies, Adhesives, Paint	3/16", 3/8" (Low nap)
Rough Wood, Drywall, Cement Block	All Paint	1/2", 3/4" (Medium nap)
Stucco, Brick, Concrete	All Paint	1" (High nap)



Applying primer to new drywall.

P PROFESSIONAL GRADE ROLLERS - Poly blend with phenolic core.

Size	Nap	Painting Surface	Standard Pack	Item Number
9"	3/16"	Smooth	12	49050
	1/2"	Semi-smooth		49051
	3/4"	Rough		49052



49050

P INDUSTRIAL GRADE ROLLERS - Poly blend with PVC core.

Size	Nap	Painting Surface	Standard Pack	Item Number
3"	3/8"	Semi-smooth	24	49046
4"	3/8"	Semi-smooth	12	49044
	3/4"	Rough		49045
9"	3/16"	Smooth	12	49061
	1/2"	Semi-smooth		49062
	3/4"	Rough		49063



49045



49063

V VORTEC PRO® ROLLERS - Poly blend with PVC core. Reliable and efficient rollers at a value price.

Size	Nap	Painting Surface	Standard Pack	Item Number
9"	3/8"	Semi-smooth	12	49070
	1/2"	Semi-smooth		49071



49070

P SPECIALTY ROLLERS - Can be used with all paints. Ideal for trim and touch-up.

Description	Overall Length	Std. Pack	Item No.
3" Roller with 3/8" nap. Standard duty frame	11-1/2"	24	49016
3" Roller with 3/8" nap. Wire frame with two tin end caps. Bent wire handle.	6-1/8"	12	49015
4" Micro Perlon Roller Reach	16-3/8"	24	49025
4" Micro Perlon Twin Pack Cover	4-1/8"	24	49066



49015

49025

P FRAMES - All metal with two plastic caps. Solid plastic handle with threaded grip. Can be used with threaded handle #44300 on page 152.

Size	Description	Overall Length	Standard Pack	Item Number
3"	Standard-duty 1/4" dia. frame with 4 wire cage	11-3/8"	24	49019
4"	Standard-duty 1/4" dia. frame with 4 wire cage	11-3/4"	24	49018
9"	Heavy-duty 5/16" dia. frame with 5 wire cage	13-1/2"	12	49022



49018

V VORTEC PRO FRAME - Reliable and efficient frame at a value price.

Size	Description	Overall Length	Standard Pack	Item Number
9"	Standard-duty 1/4" dia. frame with 4 wire cage	12-3/4"	24	49020

P PAINT TRAYS - A variety of trays available to meet users' specific needs.

Description	Paint Capacity	Standard Pack	Item Number
4" Plastic tray	1 Quart	24	49008
9" Galvanized steel tray; Rust resistant	2 Quart	24	49010
9" Paint tray liner	2 Quart	24	96702



49010

V VORTEC PRO PAINT TRAY - Reliable and efficient tray at a value price.

Description	Paint Capacity	Standard Pack	Item Number
9" Economy plastic tray; Rust proof	2 Quart	20	49011



49011

COATED ABRASIVES

NON-WOVEN ABRASIVES

POWER BRUSHES

NYLON BRUSHES

PACKAGED ITEMS

MAINTENANCE

ALPHABETICAL INDEX

Description	Page	Description	Page	Description	Page
Burr-Rx	113-124	Snagging Wheels	17	U	
Cup Brushes	115	Solutions Showcases		Unitized Wheels	44
Disc Brushes	118-119	Coated Abrasives	24-25	Upholstery/Spotting Brush	155
Drive Arbors	127	Nylox Brushes	102-103	Upright Brooms	152
End Brushes	120, 121	Power Brushes	48-49	Utility Brushes	157
Engineered Products	111	Spanner Wrench	17, 33, 37	Utility Scrub Brushes	157
Tube Brushes	116-117	Spoke Brush	155		
Wheel Brushes	113, 122-125	S.P.O.T. Safety Training	8	V	
Nylon Tube Brushes	84, 158	Squeegees	154	Valve Guide Brushes	84
Nylon Wheels	72	Stem-Mounted Brushes		Varnish Brushes	169, 171
Nylox Nylon Abrasive Filament Brushes	100-128	Circular Flared	79, 131	Vat Brush	158
Nylox Technical Information	102-110	Concave	71	Vehicle Care Brushes	155
		Conflex Brushes	70-71, 130-131	Vehicle Wash Brushes	155
O		Controlled Flare	78	Vending Ready Products	129-133
Ordering Information	5	Crimped Wire Cup	75, 131		
		Crimped Wire End	77-79, 131, 138	W	
P		Crimped Wire Wheels (Conflex)	70-71, 130, 137	WPS	9
Paint Brushes	169-171	Encapsulated	78-79	Wall Dusting Brush	160
Paint Brush Technical Information	168	Knot Wire End	76, 131, 138	Wall Paint Brushes	169
Paint Rollers and Frames	175	Knot Wire Wheels	61	Watercolor Brushes	173
Paint Trays	175	Miniature	90-91	Website	7
Parts Cleaning Brushes	170	Nylon Abrasive Filament (Nylox)	87, 115, 121	Weld Cleaning Brushes	62-63, 130, 136
Pencil End Brushes	83	Pencil End	79	Wet Mops	159
Percolator Brushes	158	Pilot Bonding	78	Wheel Brushes	
Perma-Sweep Floor Brushes	146	Stencil Brushes	174	Abrasive Flap	40-41, 45, 133
Pilot Bonding Brushes	78	Street Brooms	149	Crimped Wire-Bench Grinder	65
Pipeliners Wheels	21	Stringer Bead Brushes	62-63, 130, 136	Crimped Wire-Encapsulated	65-67, 69
Plastic Adapters	17, 59, 69, 113, 127	Strip Brooms	148	Crimped Wire-Medium Face	66
Plater's Brushes	164	Strip Brushes	94-97	Crimped Wire-Non-Sparking	92
Plater's Brass Wire Wheels	66	Stylus Brush	174	Crimped Wire-Wide Face	67
Power Brushes	47-99	Surface Conditioning Discs	46	Knot Wire-Bevel Brushes	61
Power Brush Technical Information	48-56			Knot Wire-Cable Twist	59-60, 130, 136
Pressboard Adapters	126	T		Knot Wire-Encapsulated	63
Pro-Flex™ Sweeps	145	Tampico Wheels	72	Knot-Wire Non-Sparking	92
Professional Paint Brushes	169-170	Technical Information		Knot Wire-Standard Twist 57-58, 60-61, 130, 136	130, 136
Push Brooms	144-149	Abrasive Flap Discs	24-27	Knot Wire-Stringer Bead Twist	62-63, 130, 136
Push Broom Handles	149-150	Bonded Abrasives	11-13	Miniature	90
		Maintenance Products	142-143	Nylon	72
		Non-Woven Abrasives	54	Nylon Abrasive Filament (Nylox)	113, 122-125
		Nylon Abrasive Filament Brushes (Nylox)	102-110	Plater's	66
		Paint & Varnish	168	Small Diameter (Copper Center)	68-69
		Power Brushes	48-56	Stem-Mounted	70-71, 130, 137
		Tiger® Abrasive Flap Discs	28-33, 133	Tampico	72
		Tiger Angled Flap Discs	32	Whisk Brooms	152
		Tiger Big Cat® Flap Discs	30, 133	Whitewash Brush	161
		Tiger BobCat™ Flap Discs	33	Wide Face Brushes	98-99
		Tiger Paw™ Abrasive Flap Discs	29-30, 133	Window Brushes	154
		Tiger Trim Flap Discs	32, 133	Window Squeegees	154
		Tiger X Flap Discs	28	Wire Brooms	149
		Tiger Flap Wheels	40	Wire Duster	165
		Tire Cleaning Brush	155	Wire Stripping Brushes	69
		TRIM-KUT Discs	39	Wolverine®	
		Troubleshooting Guides		Cutting Wheels	15-17
		Power Brushes	56	Grinding Wheels	19
		Nylox	112	Snagging Wheels	16
		Tube Brushes		Combo Wheels	21
		Non-Sparking	93	Flap Discs	29-30
		Nylon	84, 158	Flap Wheels	41, 133
		Nylon Abrasive Filament (Nylox)	116-117	Knot Wire Wheels	57, 60, 63
		Wire	81-84, 132	Crimped Wire Wheels	65-67, 70-71
		Tube Fitting Brushes	132, 167	Wire Cup Brushes	74-75
		Turbo Tube Brushing Tool	167	Wire End Brushes	76-77

ITEM NUMBER INDEX

Item No.	Page	Item No.	Page	Item No.	Page	Item No.	Page	Item No.	Page	Item No.	Page
00104	64	03140	67	07725	69, 113	09180	58	10047	79	11115	78
00105	64	03150	67	07726	69	09200	62	10048	79	11140	76
00114	64	03160	67	07727	69	09379	59	10050	79	11141	76
00124	64	03180	67	07729	69, 113	09386	62	10056	78	11142	79
00134	64	03190	67	07746	61	09396	62	10057	78	11160	114, 121
00135	64	03200	67	07756	41	09400	62	10058	78	11161	114, 121
00144	64	03210	67	07761	44	09400P	136	10059	78	11162	114, 121
00154	64	03220	67	07764	44	09400V	130	10067	93	11165	114, 121
00156	70	03230	67	07766	33	09410	58	10073	79	11166	114, 121
00184	64	03240	67	07769	61	09430	58	10074	79	11169	114, 121
00204	64	03403	126	07771	61	09440	58	10076	79	11170	114, 121
00214	64	03404	126	07771P	137	09460	58	10091	93	12120	74
00234	64	03405	126	07772	61	09480	58	10099	79	12206	73
00244	64	03480	67	07772P	137	09490	58	10128	93	12256	73
00264	64	03510	67	08004	57	09500	62	10134	79	12276	73, 131
00274	64	03520	67	08014	57	09510	58	10141	76	12276P	137
01035	64	03590	67	08014P	136	09530	58	10141V	131	12301	74
01045	64	03680	67	08014V	130	09540	58	10142	76	12306	73
01049	64	03809	66, 72, 126	08024	57	09719	57	10150	79	12316	73, 131
01055	64	03810	66, 72, 126	08034	57	09790	58	10151	79	12316P	137
01065	64	03811	66, 72, 126	08044	57	09799	58	10152	114, 121	12326	73
01068	64	03812	66, 72, 126	08044P	136	09800	58	10153	114, 121	12356	73, 131
01075	64	03813	66, 72, 126	08045	57	09809	58	10154	114, 121	12376	73, 131
01075P	136	03814	66, 72, 126	08064	57	09840	58	10155	114, 121	12376P	137
01085	65	03824	66, 72, 126	08075	57	09856	62	10156	114, 121	12396	73
01095	65	03833	41	08085	57	09866	62	10157	114, 121	12406	73
01115	65	03834	41	08085P	136	09870	57	10158	93	12416	73
01125	65	03835	41	08095	57	09980	58	10172	114, 121	12456	73
01135	64	03890	126	08105	57	09990	58	10173	114, 121	12476	73
01138	64	03892	126	08106	60	10001	77	10174	114, 121	12536	74
01145	64	03893	126	08125	57	10001V	131	10187	76	12556	74
01148	64	03895	126	08135	57	10002	77	10188	77	12576	74
01155	64	03910	126	08138	57	10003	77	10208	76	12636	74
01158	64	03911	126	08145	57	10004	77	10210	76	12676	74
01165	64	03912	126	08155	57	10005	77	10211	76	12686	74
01168	64	03913	126	08178	57	10005V	131	10212	76	12726	74
01175	64	03915	126	08179	57	10006	77	10213	76	12736	73
01175P	136	03920	126	08189	57	10007	77	10215	76	12746	73
01178	64	03921	126	08200-14	57	10008	77	10216	76	12756	74
01179	64	03922	126	08209	57	10008P	138	10217	76	12766	74
01228	64	03923	126	08219	57	10008V	131	10218	76	12776	92
01238	64	03925	126	08254	57	10009	77	10220	76	12796	74
01248	64	03931	126	08264	57	10009V	131	10301	78	12816	73
01250-12	64	03933	126	08264V	130	10010	77	10302	78	12826	73
01258	64	03934	126	08271	92	10010V	131	10303	78	12846	73
01259	64	03936	126	08274	57	10011	77	10305	78	12856	73
01299	64	03944	126	08284	57	10012	77	10306	78	12866	73
01309	64	03945	126	08294	57	10012P	138	10307	78	12886	73
01319	64	03946	126	08300	58	10012V	131	10309	78	12906	74
01320-14	64	03954	126	08309	58	10013	77	10310	78	12916	74
01329	64	03955	126	08310	58	10013V	131	10311	78	12926	74
01339	64	03956	126	08314	57	10014	77	10313	78	13001	138
01349	64	03960	126	08319	58	10015	77	10314	78	13002	138
01415	88	03963	126	08325	57	10016	77	10315	78	13009	73
01475	88	03965	126	08330	58	10017	77	10317	78	13015	73
01501	65	03973	126	08339	58	10017V	131	10319	78	13016	73
01502	65	03974	126	08345	57	10018	77	10321	78	13020	73
01503	65	03975	126	08346	60	10019	77	10322	78	13021	73
01504	65	04400	69, 113, 127	08375	57	10020	77	10323	78	13025	73, 131
01505	65	04401	69, 113, 127	08395	57	10021	77	10370	77	13025P	137
01506	65	04402	69, 113, 127	08534	59	10021V	131	10371	77	13077	70
01508	65	04403	69	08534V	130	10022	77	10372	77	13078	70
01509	65	04455	16	08565	59	10022V	131	10373	77	13081	70
01511	65	06020	66	08565V	130	10023	77	10374	77	13085	70
01512	65	06040	66	08615	59	10024	77	10375	77	13100	60
01513	65	06050	66	08695	59	10025	76	10376	77	13101	60
01514	65	06060	66	08750	62	10025P	138	10377	77	13102	60
01515	65	06070	66	08756	62	10026	76	10378	77	13103	60
01517	65	06080	66	08756V	130	10026P	138	10379	77	13105	60
01518	65	06090	66	08766	62	10026V	131	10380	77	13106	60
01675	64	06100	66	08766V	130	10027	76	10381	77	13106P	136
01695	64	06110	66	08775	62	10027P	138	10387	76	13106V	130
01705	64	06120	66	08776	62	10027V	131	10388	76	13107	60
01775	64	06150	66	08776P	136	10028	76	10392	76	13108	60
01795	64	06160	66	08776V	130	10028P	138	10393	76	13109	60
01805	64	06170	66	08786	62	10028V	131	11000	77	13110	60
01809	64	06180	66	08796	62	10029	76	11001	77	13113	60
01898	64	06190	66	08806	62	10029V	131	11003	77	13113P	136
01939	64	06200	66	08806V	130	10030	76	11004	77	13113V	130
01949	64	06440	66	08835	57	10031	76	11006	77	13114	60
02325	66	06450	66	08878	59	10031V	131	11007	77	13115	60
02325P	136	06490	66	08879	59	10032	76	11010	77	13116	60
02335	66	06530	66	08916	62	10033	79	11011	77	13117	60
02335P	136	06620	66	08926	62	10034	79	11013	77	13119	60
03000	67	06645	67	08954	62	10035	79	11014	77	13120	60
03010	67	06645P	136	08975	57	10037	79	11016	77	13120V	130
03020	67	06655	67	09000	62	10038	79	11017	77	13121	88
03030	67	07700	127	09000P	136	10039	79	11009	78	13124	62
03040	67	07701	127	09000V	130	10040	79	11101	78	13125	62
03050	67	07702	127	09020	58	10041	79	11102	78	13125P	136
03060	67	07703	127	09049	58	10041V	131	11103	78	13126	62
03070	67	07715	127	09080	58	10042	79	11105	78	13127	62
03090	67	07721	69, 113	09100	62	10043	79	11110	78	13128	62
03100	67	07722	69, 113	09104	58	10044	79	11112	78	13130	62
03110	67	07723	69, 113	09134	58	10045	79	11113	78	13131	62
03130	67	07724	69, 113	09160	58	10046	79	11114	78	13131P	136

ITEM NUMBER INDEX

Item No.	Page	Item No.	Page	Item No.	Page	Item No.	Page	Item No.	Page	Item No.	Page
13131V	130	14206	75, 131	17263	72	17967	71	21108	81	21761	117
13132	62	14216	75	17443	72	17968	71	21108V	132	21762	117
13134	62	14256	75	17453	72	17969	71	21109	81	21763	117
13135	62	14300	75	17532	113	17971	71	21110	81	21764	117
13137	62	14301	75	17533	113	17972	71	21110V	132	21765	117
13138	62	14301V	131	17535	113	17973	71	21111	81	21766	117
13138P	136	14302	75, 131	17541	113	17974	71	21112	81	22021	66
13138V	130	14303	75	17542	113	17975	71	21113	81	22061	66
13150	73	14304	75	17543	113	17976	71	21114	81	22241	66
13151	73	14306	75	17548	113	17977	71	21114V	132	22602	117
13152	73	14310	93	17551	113	17978	71	21115	81	22603	117
13153	73	14311	93	17555	113	17979	71	21116	81	22604	117
13155	73	14313	75	17556	113	17981	71	21117	81	22605	117
13156	73, 131	14314	93	17557	113	17982	71	21118	81	22606	117
13156P	137	14315	75	17563	113	20180	72	21119	81	22607	117
13159	73	14316	93	17565	113	20190	72	21120	81	22608	117
13160	73	14317	75	17567	113	20490	72	21121	81	22610	117
13163	73, 131	14318	75	17568	113	20510	72	21122	81	22614	117
13175	75	14319	75	17600	71	20600	123	21123	81	22616	117
13176	75	14320	75	17601	71	20610	123	21124	81	25100	163
13177	75	14321	75	17602	71	20620	123	21125	81	25104	163
13178	75	14401	115	17603	71	20630	123	21126	117	25150	163
13181	75, 131	14403	115	17604	71	20650	123	21128	117	25154	163
13182	75	14404	115	17605	71	20661	123	21130	117	25201	163
13184	75	14413	115	17608	71	20730	123	21132	117	25202	163
13185	75	14414	115	17609	70	21000	83	21133	117	25211	164
13187	75	14506	115	17610	70	21001	83	21134	117	25212	165
13188	75	14516	115	17610V	130	21004	83	21136	117	25221	170
13201	60	14576	115	17611	70	21005	83	21138	117	25222	170
13208	60	14606	93	17611V	130	21008	83	21139	93	25238	149
13231	90	14616	93	17612	70	21009	83	21142	82	25239	149
13232	62	15071	68	17614	70	21014	83	21143	82	25241	149
13232V	130	15101	68	17615	70	21015	83	21144	82	25242	149
13234	62	15111	68	17615P	137	21020	83	21146	82	25251	153
13238	62	15131	68	17615V	130	21021	83	21148	82	25252	153
13240	75	15141	68	17616	70	21023	83	21149	82	25262	157
13240P	137	15151	68	17616V	130	21025	83	21150	82	25263	157
13241	75	15302	68	17617	70	21027	83	21152	93	25271	154
13242	75	15312	68	17617P	137	21028	83	21161	83	25290	148
13243	75	15322	68	17618	70	21030	83	21162	83	25291	148
13244	75	15332	68	17618V	130	21031	83	21164	81	25294	148
13245	75, 131	15433	68	17619	71	21034	83	21165	93	25295	148
13245P	137	15443	68	17620	71	21035	83	21167	81	25297	150
13249	62	15453	68	17621	71	21036	83	21175	82	25299	148
13253	73	15463	68	17622	71	21040	83	21178	93	26000	90
13254	73	15473	68	17623	71	21041	83	21179	93	26001	90
13255	73	15513	68	17628	113	21044	83	21181	82	26003	90
13256	73	15523	68	17629	113	21050	83	21182	93	26004	90
13257	73	15533	68	17633	113	21051	83	21184	81	26005	90
13258	73, 131	15543	68	17637	71	21053	83	21191	93	26012	90
13261	60	15553	68	17641	92	21055	83	21203	82	26014	90
13266	60	15563	68	17641V	130	21056	83	21218	93	26015	90
13266P	136	15573	68	17680	61	21057	83	21219	93	26016	90
13266V	130	15637	68	17681	61	21058	83	21221	93	26017	90
13272	60	15647	68	17681V	130	21072	82	21232	82	26021	90
13276	60	15667	68	17682	61	21073	82	21233	83	26041	90
13281	73	15677	68	17684	61	21073V	132	21236	81	26042	90
13281P	137	15732	68	17686	61	21074	82	21240	82	26043	90
13282	73	15753	68	17687	61	21074V	132	21245	81	26059	90
13283	73	15762	68	17687V	130	21075	82	21246	83	26071	90
13284	73	15863	68	17689	61	21075V	132	21247	81	26072	90
13285	73	16263	113	17691	61	21076	82	21249	83	26074	90
13286	73, 131	16310	113	17901	71	21077	82	21252	81	26076	90
13286P	137	16315	113	17902	71	21077V	132	21264	82	26075	90
13299	92	16315	113	17903	71	21078	82	21265	82	26091	90
13300	74	16461	68	17906	71	21078V	132	21266	82	26093	90
13301	74	16471	68	17907	71	21079	82	21267	82	26094	90
13302	74	16511	68	17909	71	21080	82	21269	82	26095	90
13401	61	16521	68	17912	71	21081	82	21270	93	26096	90
13402	61	16712	68	17914	71	21081V	132	21282	82	26097	91
13406	61	16833	68	17915	71	21082	82	21304	117	26098	91
13416	61	16843	68	17917	71	21083	82	21305	117	26099	91
13423	61	16853	68	17922	71	21084	82	21306	117	26101	91
13426	61	16873	68	17923	71	21085	82	21308	117	26106	91
13436	61	16933	68	17930	71	21086	82	21309	117	26107	91
13456	61	16943	68	17931	71	21087	82	21311	117	26108	91
13466	61	16963	68	17933	71	21088	82	21312	117	26113	91
13476	61	16973	68	17935	71	21089	82	21322	82	26114	91
13486	61	17202	80	17936	71	21090	83	21325	117	26115	91
13709	73	17203	80	17937	71	21091	83	21326	117	26116	91
13710	73	17205	80	17950	71	21092	83	21327	117	26119	91
13711	73	17206	116	17951	71	21093	83	21328	117	26121	91
13712	73	17207	80	17952	71	21094	83	21329	117	26122	91
13715	73	17208	116	17953	71	21095	83	21330	117	26128	91
13716	73	17209	80	17954	71	21096	83	21332	93	26131	91
13717	73	17210	116	17955	71	21097	83	21340	82	26133	91
13718	73	17211	80	17956	71	21098	83	21342	81	26136	87, 114, 121
14016	75	17212	116	17957	71	21099	83	21345	117	26138	87, 114, 121
14026	75, 131	17214	80	17958	71	21100	83	21404	82	26140	90
14036	75	17215	116	17959	71	21101	83	21413	81	26141	90
14036P	137	17216	80	17961	71	21103	83	21414	83	26143	90
14066	75, 131	17217	116	17962	71	21104	83	21473	117	26144	90
14076	75	17218	80	17963	71	21105	83	21757	117	26146	87, 114, 121
14076P	137	17219	80	17964	71	21106	81	21758	117	26155	90
14126	75	17223	72	17965	71	21107	81	21759	117	26294	90
14166	75	17233	72	17966	71	21107V	132	21760	117	26296	90

ITEM NUMBER INDEX

Item No.	Page	Item No.	Page	Item No.	Page	Item No.	Page	Item No.	Page	Item No.	Page
26900	116	31346	29	34165	87	34261	88	34356	87	36287	76
26901	116	31347	29	34166	87	34262	88	34357	87	36288	76
26902	116	31349	29	34167	87	34263	88	34358	87	36289	76
26903	116	31350	29	34168	87	34264	88	35006	74	36290	57
26904	116	31351	29	34169	87	34265	88	35070	69	36293	57
26905	116	31352	29	34170	87	34266	88	35084	65	36295	63
26906	116	31353	29	34171	87	34267	88	35105	65	36296	63
26907	116	31355	29	34172	87	34268	88	35117	65	36297	63
26908	116	31356	29	34173	87	34269	88	35135	65	36303	167
26909	116	31357	29	34174	87	34270	89	35160	67	36304	167
26910	116	31358	29	34175	87	34271	89	35186	74	36305	167
26911	116	31361	29	34176	87	34272	89	35206	63	36307	63
26912	116	31362	29	34177	87	34273	89	35216	63	36666	159
26913	116	31363	29	34178	87	34274	89	35222	79	40000	169
26914	116	31364	29	34179	87	34275	89	35223	79	40001	169
26915	116	31367	29	34180	87	34276	89	35224	79	40002	169
29059	92	31368	29	34181	87	34277	89	35226	79	40004	169
29070	72	31369	29	34182	87	34278	89	35233	79	40008	169
29078	92	31370	29	34183	87	34279	89	35234	79	40010	169
29086	92	31387	30	34184	87	34280	89	35240	69	40011	169
29088	113	31388	30	34185	87	34281	89	35250	69	40014	169
29123	113	31389	30	34186	87	34282	89	35260	69	40017	169
29178	92	31390	30	34187	87	34283	89	35293	69	40018	169
29280	113	31391	30	34188	87	34284	89	35294	69	40019	170
29353	113	31392	30	34189	87	34285	89	35305	70	40020	170
29356	113	31401	29	34190	88	34286	89	35310	70	40021	170
30711	41	31402	29	34191	88	34287	89	35315	70	40022	169
30712	41	31403	29	34192	88	34288	89	35340	78	40023	169
30713	41	31404	29	34193	88	34289	89	35345	78	40026	172
30715	41	31407	29	34194	88	34290	89	35350	78	40027	172
30716	41	31408	29	34195	88	34291	89	35406	74	40028	172
30717	41	31409	29	34196	88	34292	89	35416	70	40029	172
30719	41	31410	29	34197	88	34293	89	35500	78	40030	172
30720	41	31414	29	34198	88	34294	89	35505	78	40031	172
30720V	133	31415	29	34199	88	34295	89	35520	65	40032	172
30721	41	31419	29	34200	88	34296	89	35530	74	40035	170
30721V	133	31420	29	34201	88	34297	89	35535	78	40036	170
30722	41	31421	29	34202	88	34298	87	35540	78	40040	169
30723	41	31422	29	34203	88	34299	87	35545	78	40041	169
30723V	133	34105	87	34204	88	34359	87	35600	63	40056	170
30724	41	34106	87	34205	88	34300	87	35760	74	40058	169
30724V	133	34107	87	34206	88	34301	87	35800	63	40059	169
30725	41	34108	87	34207	88	34302	87	35808	69	40060	169
30726	41	34109	87	34208	88	34303	87	35821	82	40061	169
30726V	133	34110	87	34209	88	34304	87	35822	82	40062	169
30727	41	34111	87	34210	88	34305	87	35823	82	40065	172
30727V	133	34112	87	34211	88	34306	87	35825	82	40066	172
30728	41	34113	87	34212	88	34307	87	36200	65	40067	172
30729	41	34114	87	34213	88	34308	87	36201	65	40068	172
30732	41	34115	87	34214	88	34309	87	36203	66	40069	172
30735	41	34116	87	34215	88	34310	87	36204	67	40070	172
30736	41	34117	87	34216	88	34311	87	36205	65	40071	172
30737	41	34118	87	34217	88	34312	87	36206	67	40074	171
30738	41	34119	87	34218	88	34313	87	36207	70	40076	172
30745	41	34120	87	34219	88	34314	87	36208	71	40077	174
30746	41	34121	87	34220	88	34315	87	36209	71	40078	174
30771	41	34122	87	34221	88	34316	87	36211	71	40080	174
30778	41	34123	87	34222	88	34317	87	36212	60	40082	174
31074	124	34124	87	34223	88	34318	87	36213	60	40089	171
31084	124	34125	87	34224	88	34319	87	36215	60	40101	171
31094	124	34126	87	34225	88	34320	87	36216	60	40103	171
31100	124	34127	87	34226	88	34321	87	36217	60	40104	171
31101	124	34128	87	34227	88	34322	87	36218	63	40106	169
31102	124	34129	87	34228	88	34323	87	36219	63	40107	171
31103	124	34130	87	34229	88	34324	87	36224	60	40108	171
31104	124	34131	87	34230	88	34325	87	36225	63	40109	171
31105	124	34133	87	34231	88	34326	87	36226	57	40110	171
31110	124	34134	87	34232	88	34327	87	36227	57	40111	171
31111	128	34135	87	34233	88	34328	87	36228	57	40113	169
31112	128	34136	87	34234	88	34329	87	36230	75	40114	169
31114	124	34137	87	34235	88	34330	87	36231	75	40115	169
31121	124	34138	87	34236	88	34331	87	36232	75	40116	170
31122	124	34139	87	34237	88	34332	87	36236	75	40118	170
31123	124	34141	87	34238	88	34333	87	36237	75	40119	170
31124	124	34142	87	34239	88	34334	87	36238	74	40120	170
31134	124	34143	87	34240	88	34335	87	36239	74	40121	170
31135	124	34144	87	34241	88	34336	87	36244	74	40122	170
31136	124	34145	87	34242	88	34337	87	36245	74	40137	172
31137	124	34146	87	34243	88	34338	87	36246	77	40139	172
31240	124	34147	87	34244	88	34339	87	36247	77	40140	172
31241	124	34148	87	34245	88	34340	87	36248	77	40141	172
31245	124	34149	87	34246	88	34341	87	36249	77	40177	172
31255	124	34150	87	34247	88	34342	87	36250	76	40179	172
31265	124	34151	87	34248	88	34343	87	36251	76	40180	172
31270	124	34152	87	34249	88	34344	87	36255	60	40181	172
31275	124	34153	87	34250	88	34345	87	36257	60	40182	172
31280	124	34154	87	34251	88	34346	87	36258	60	40183	172
31285	124	34155	87	34252	88	34347	87	36259	71	40184	172
31290	124	34156	87	34253	88	34348	87	36262	65	40185	172
31337	29	34158	87	34254	88	34349	87	36265	67	40160	172
31338	29	34159	87	34255	88	34350	87	36279	57	40161	172
31339	29	34160	87	34256	88	34351	87	36282	77	40162	172
31340	29	34161	87	34257	88	34352	87	36283	77	40163	172
31343	29	34162	87	34258	88	34353	87	36284	77	40164	172
31344	29	34163	87	34259	88	34354	87	36285	77	40165	172
31345	29	34164	87	34260	88	34355	87	36286	76	40166	172

ITEM NUMBER INDEX

Item No.	Page	Item No.	Page	Item No.	Page	Item No.	Page	Item No.	Page	Item No.	Page
41000	173	44020	150	44260	165	44862	147	50136	30	50923	33
41001	173	44021	151	44261	174	44863	149	50137	30	50924	33
41002	173	44023	156	44262	174	44864	149	50138	30	50925	33
41003	173	44024	156	44263	174	44865	149	50139	30	50926	33
41004	173	44025	156	44266	152	44866	149	50140	30	50932	33
41005	173	44026	156	44290	151	44867	149	50141	30	50933	33
41007	173	44027	156	44299	163	44868	149	50502	31	50934	33
41008	173	44028	156	44300	150	44871	148	50503	31	50935	33
41009	173	44029	156	44301	150	44872	148	50504	31	50936	33
41010	173	44031	161	44302	150	44873	149	50505	31	50946	33
41011	173	44032	161	44303	150	44874	149	50506	31	50947	33
41012	173	44034	161	44305	152	44875	155	50509	31	50948	33
41013	173	44035	166	44306	150	44879	162	50510	31	50949	33
41018	173	44036	166	44307	155	44880	162	50511	31	50950	33
41019	173	44037	166	44314	158	44881	162	50512	31	50951	33
41020	173	44038	166	44315	155	44882	162	50513	31	50952	33
41021	173	44047	166	44316	84, 158	44883	161	50513V	133	50953	33
41022	173	44048	166	44317	151	44884	161	50514	31	50954	33
41023	173	44053	132, 163	44318	155	44885	148	50514V	133	50955	33
41024	173	44054	132, 163	44319	151	45500	154	50515	31	50956	33
41025	173	44055	163	44351	153	45506	154	50516	31	50957	33
42001	147	44056	163	44354	153	45507	154	50517	31	50958	33
42002	147	44057	163	44391	156	45510	154	50518	31	50959	33
42006	147	44058	163	44395	156	45511	154	50518V	133	50960	33
42007	147	44061	163	44416	157	45534	154	50519	31	50961	33
42008	147	44062	163	44418	157	45535	154	50519V	133	50962	33
42013	147	44063	132, 163	44428	156	45537	154	50520	31	50963	33
42014	147	44064	132, 163	44429	156	45538	154	50522	31	50964	33
42016	147	44065	163	44432	163	49008	175	50523	31	50965	33
42017	147	44066	165	44434	156	49010	175	50524	31	51101	29
42021	149	44067	165	44435	150	49011	175	50525	31	51102	29
42022	149	44069	164	44438	156	49015	175	50526	31	51104	29
42023	149	44070	165	44448	161	49016	175	50532	31	51105	29
42025	149	44073	165	44451	165	49018	175	50533	31	51107	29
42026	149	44074	165	44499	151	49019	175	50534	31	51108	29
42030	149	44075	164	44510	155	49020	175	50538	28	51109	29
42032	149	44075V	132	44546	152	49022	175	50539	28	51110	29
42033	149	44076	164	44547	152	49025	175	50540	28	51112	29
42035	147	44077	164	44548	152	49044	175	50541	31	51113	29
42037	147	44078	167	44551	164	49045	175	50542	31	51114	29
42041	147	44079	167	44553	146	49046	175	50543	31	51115	29
42042	147	44080	167	44561	151	49050	175	50544	31	51118	29
42047	147	44080V	132	44562	151	49051	175	50545	31	51119	29
42049	147	44081	167	44563	151	49052	175	50546	31	51119V	133
42054	149	44082	167	44571	150	49061	175	50592	29	51120	29
42055	149	44083	167	44572	150	49062	175	50593	29	51120V	133
42095	147	44084	167	44573	150	49063	175	50594	29	51121	29
42098	147	44085	167	44574	150	49066	175	50595	29	51123	29
42099	149	44086	167	44577	150	49070	175	50601	29	51124	29
42114	147	44087	167	44578	150	49071	175	50606	29	51124V	133
42134	148	44088	174	44581	146	50002	32	50616	29	51125	29
42135	148	44088V	132	44582	146	50003	32	50649	29	51125V	133
42138	149	44089	174	44584	146	50004	32	50650	29	51126	29
42149	149	44089V	132	44587	146	50005	32	50651	29	51128	29
42163	146	44090	174	44590	146	50006	32	50659	29	51129	29
42164	146	44090V	132	44591	146	50006V	133	50660	29	51130	29
42165	146	44097	174	44594	163	50007	32	50661	29	51131	29
42166	146	44099	152	44600	145	50007V	133	50693	29	51132	29
42167	146	44100	163	44601	145	50008	32	50694	29	51133	29
42168	146	44101	163	44604	145	50009	32	50695	29	51134	29
42173	149	44103	152	44606	145	50010	32	50696	29	51135	29
42174	149	44110	84, 158	44609	164	50011	32	50699	29	51137	29
42210	155	44111	84, 158	44619	164	50012	32	50706	29	51138	29
42213	153	44112	84, 158	44624	151	50014	32	50713	29	51139	29
42352	144	44113	84, 158	44635	150	50015	32	50714	29	51140	29
42353	144	44114	84, 158	44637	164	50016	32	50715	29	51142	29
42354	144	44115	84, 158	44637V	132	50100	28	50746	29	51143	29
42355	144	44116	164	44660	164	50101	28	50803	30	51145	29
42356	144	44117	164	44663	157	50102	28	50803V	133	51146	29
42357	144	44118	164	44690	167	50103	28	50804	30	51147	29
42360	144	44119	164	44692	156	50104	28	50804V	133	51148	29
42365	144	44124	166	44693	156	50105	28	50805	30	51149	29
42368	144	44125	166	44699	156	50105V	133	50806	30	51150	29
42371	144	44128	166	44731	164	50106	28	50808	30	51153	29
42372	144	44131	166	44732	164	50106V	133	50808V	133	51154	29
42373	144	44133	166	44733	164	50107	28	50809	30	51155	29
42375	144	44135	166	44734	167	50108	28	50809V	133	51156	29
42376	144	44137	166	44735	167	50109	28	50810	30	51157	29
42380	144	44139	166	44736	167	50110	28	50823	30	51158	29
42381	144	44144	128	44737	167	50111	28	50824	30	51160	30
42382	144	44149	166	44738	167	50112	28	50825	30	51161	30
42383	150	44150	166	44739	167	50113	28	50843	30	51162	30
44001	158	44152	166	44805	165	50114	28	50844	30	51163	30
44003	153	44154	166	44806	165	50115	28	50845	30	51164	30
44004	153	44156	166	44810	165	50117	32	50846	30	51165	30
44007	152	44159	166	44819	147	50118	32	50902	33	51166	30
44008	152	44167	164	44851	147	50119	32	50903	33	51167	30
44009	152	44167V	132	44852	147	50121	32	50904	33	51168	30
44010	161	44169	166	44853	147	50122	32	50905	33	51169	30
44011	161	44189	164	44855	147	50123	32	50906	33	51170	30
44013	157	44189V	132	44856	147	50130	30	50912	33	51171	30
44014	157	44213	84, 158	44857	147	50131	30	50913	33	51182	29
44016	157	44232	164	44858	147	50132	30	50914	33	51183	29
44017	157	44235	163	44859	147	50133	30	50915	33	51200	28
44018	150	44240	164	44860	147	50134	30	50916	33	51201	28
44019	150	44251	164	44861	147	50135	30	50922	33	51201V	133

ITEM NUMBER INDEX

Item No.	Page	Item No.	Page	Item No.	Page	Item No.	Page	Item No.	Page	Item No.	Page
51202	28	52011	40	56466	19	58013	16	58231	18	59711	36
51202V	133	52015	40	56467	19	58014	16	58232	18	59712	36
51203	28	52016	40	56468	19	58020	15	58233	18	59713	36
51204	28	52017	40	56470	19	58021	15	58234	18	59714	36
51205	28	52024	40	56473	19	58022	15	58300	15	59715	36
51205V	133	52025	40	56474	16	58023	15	58301	15	59716	36
51206	28	52027	40	56475	15	58030	15	58302	15	59717	36
51206V	133	52028	40	56476	15	58031	15	58303	15	59731	36
51207	28	52029	40	56477	15	58032	15	58305	15	59732	36
51208	28	52366	40	56484	16, 33	58033	15	58306	15	59733	36
51209	28	52367	40	56485	39	58050	20	58307	15	59734	36
51210	28	52486	40	56489	16, 44	58051	20	58308	15	59735	36
51211	28	52487	40	56490	16	58052	20	58309	15	59736	36
51212	28	52601	40	56491	16	58053	20	58310	15	59737	36
51213	28	52603	40	56494	16, 33	58054	20	58311	15	59806	38
51214	28	52605	40	56495	16, 33	58055	20	58312	15	59807	38
51215	28	52611	40	56496	39	58057	20	58315	20	59808	38
51216	28	52613	40	57001	16	58056	20	58316	20	59809	38
51217	28	52621	40	57010	16	58058	20	58317	20	59811	38
51218	28	52623	40	57011	16	58064	20	58318	20	59812	38
51219	28	53286	40	57012	16	58066	21	58319	20	59813	38
51220	28	53287	40	57014	16	58067	21	58320	20	59814	38
51221	28	53326	40	57015	16	58068	21	58321	20	59869	38
51222	28	53327	40	57016	16	58069	18	58322	20	59870	38
51223	28	54492	44	57020	15	58070	18	58323	20	59871	38
51224	28	54500	45	57021	15	58071	18	58324	20	59874	38
51225	28	54501	45	57022	15	58072	18	58325	18	59875	38
51226	28	54502	45	57023	15	58073	18	58326	18	59876	38
51227	28	54506	45	57040	15	58074	18	58327	18	59877	38
51228	28	54507	45	57041	15	58075	18	58328	18	59901	36
51229	28	54508	45	57042	15	58076	18	58329	18	59902	36
51230	28	54509	45	57043	15	58077	18	58330	18	59903	36
51231	28	54510	45	57044	15	58078	18	58331	18	59904	36
51232	28	54511	45	57045	15	58079	18	58332	18	59905	36
51233	28	55512	44	57046	15	58080	19	58333	18	59906	36
51234	28	55513	44	57047	15	58081	19	58334	18	59907	36
51300	32	55531	44	57048	15	58082	19	58335	18	59911	36
51301	32	55541	44	57049	15	58083	19	58342	16	59912	36
51302	32	55542	44	57060	16	58090	21	58345	16	59913	36
51303	32	55546	44	57061	15	58092	21	58348	16	59914	36
51304	32	56013	16	57063	16	58094	21	58351	16	59915	36
51305	32	56015	16	57064	17	58095	21	59300	39	59916	36
51306	32	56022	16	57065	16	58100	15	59305	39	59917	36
51307	32	56060	16	57066	16	58101	15	59315	39	59931	36
51308	32	56061	16	57068	16	58102	15	59326	39	59932	36
51309	32	56062	16	57069	17	58103	15	59327	39	59933	36
51310	32	56064	17	57070	16	58107	15	59403	39	59934	36
51311	32	56065	16	57071	16	58109	15	59491	37	59935	36
51312	32	56068	16	57072	16	58110	15	59492	37	59936	36
51313	32	56070	16	57073	17	58111	15	59493	37	59937	36
51314	32	56076	16	57074	17	58112	15	59494	37	59971	37
51315	32	56080	16	57075	16	58113	15	59495	37	59973	37
51316	32	56086	16	57076	16	58114	20	59496	37	59975	37
51317	32	56099	16	57077	16	58115	20	59497	37	59976	37
51318	32	56103	15	57079	17	58116	20	59501	37	59977	37
51319	32	56108	16	57080	15	58117	20	59503	37	59978	37
51320	32	56118	15	57081	15	58118	20	59505	37	59979	37
51321	32	56128	16	57082	15	58119	20	59506	37	60040	38
51322	32	56129	16	57083	15	58120	18	59507	37	60043	38
51323	32	56130	16	57090	17	58121	18	59508	37	60044	38
51434	45	56131	17	57091	17	58122	18	59509	37	60046	38
51444	45	56163	17	57092	17	58123	18	59521	37	60053	38
51454	45	56165	16	57093	17	58124	18	59523	37	60056	38
51456	45	56166	16	57100	20	58125	18	59525	37	60057	38
51457	45	56167	16	57101	20	58126	18	59526	37	60059	38
51458	45	56230	17	57102	20	58127	18	59527	37	60118	38
51460	45	56239	17	57103	20	58128	18	59528	37	60121	38
51506	46	56240	17	57104	20	58129	18	59529	37	60122	38
51507	46	56271	16	57108	20	58130	14	59541	37	60124	38
51508	46	56273	15	57109	20	58131	14	59543	37	60131	38
51512	46	56275	15	57105	20	58200	15	59545	37	60134	38
51513	46	56277	15	57106	20	58201	15	59546	37	60135	38
51514	46	56278	15	57107	20	58202	15	59547	37	60137	38
51515	46	56279	19	57119	18	58203	15	59548	37	60150	38
51516	46	56280	19	57120	18	58205	15	59549	37	60151	38
51517	46	56281	15	57121	18	58206	15	59571	37	60152	38
51521	46	56282	15	57122	18	58207	15	59573	37	60155	38
51522	46	56283	15	57123	18	58208	15	59575	37	60156	38
51523	46	56383	15	57124	18	58209	15	59576	37	60157	38
51530	46	56384	15	57125	18	58210	15	59577	37	60170	38
51531	46	56385	15	57126	18	58211	15	59578	37	60171	38
51532	46	56391	15	57127	18	58212	15	59579	37	60172	38
51533	46	56392	15	57128	18	58215	20	59600	37	60175	38
51534	46	56393	15	57129	18	58216	20	59601	37	60176	38
51535	46	56423	15	57134	19	58217	20	59602	37	60177	38
51551	33, 38, 46	56425	20	57135	19	58218	20	59603	37	60378	38
51552	33, 38, 46	56426	20	57136	19	58219	20	59604	37	60381	38
51562	46	56427	20	57137	19	58220	20	59605	37	60382	38
51569	46	56428	20	58000	15	58221	20	59611	37	60384	38
51575	46	56429	20	58001	15	58222	20	59701	36	60391	38
51578	46	56430	20	58002	15	58225	18	59702	36	60394	38
52003	40	56449	19	58003	15	58226	18	59703	36	60395	38
52004	40	56454	19	58005	14	58227	18	59704	36	60397	38
52005	40	56455	19	58006	14	58228	18	59705	36	60400	35
52009	40	56457	19	58011	16	58229	18	59706	36	60401	35
52010	40	56464	19	58012	16	58230	18	59707	36	60402	35

ITEM NUMBER INDEX

Item No.	Page	Item No.	Page	Item No.	Page	Item No.	Page	Item No.	Page	Item No.	Page
60403	35	62058	36	70210	149	79802	67	85812	115	86167	114
60404	35	62062	36	70211	149	79803	67	85814	115	86171	124
60406	35	62063	36	70212	149	79804	67	85816	115	86172	124
60410	35	62064	36	70215	149	79805	67	85818	115	86181	118
60411	35	62065	36	70300	152	79810	67	85822	115	86182	118
60412	35	62066	36	70304	152	79811	67	85824	115	86198	114
60413	35	62067	36	70308	152	79812	67	85826	115	86199	114
60414	35	62068	36	70312	147, 155	79813	67	85832	115	86204	114
60416	35	62072	36	70324	152	79814	67	85836	115	89023	123
60420	35	62073	36	70325	152	79815	67	85842	115	89024	123
60421	35	62074	36	71019	153	83000	119	85844	115	89029	123
60422	35	62075	36	71076	160	83002	121	85850	115	89033	123
60423	35	62076	36	71077	153	83003	121	85852	115	94000	58
60424	35	62077	36	71078	153	83004	121	85854	115	94008	59
60426	35	62078	36	71079	153	83005	121	85860	115	94012	74
60508	33, 38	62082	36	71080	153	83006	121	85862	115	94026	59
60509	33, 38	62083	36	71081	153	83007	121	85900	115	94199	59
60600	35	62084	36	72034	156	83010	119	85901	115	94224	59
60601	35	62085	36	72058	156	83011	119	85908	115	95013	160
60602	35	62086	36	72086	157	83030	119	85912	115	95014	160
60603	35	62087	36	72101	157	83040	119	85914	115	95016	124
60604	35	62088	36	73050	160	83050	119	85920	115	95027	84
60606	35	65204	42	73055	160	83070	119	85922	115	95028	84
60610	35	65205	42	73111	156, 162	83100	119	85930	115	95029	84
60611	35	65206	42	73146	155	83110	119	85932	115	95084	84
60612	35	65207	42	73156	155	83111	119	85938	115	95129	84
60613	35	65208	42	73180	148	83116	121	85940	115	95151	160
60614	35	65209	42	73182	148	83130	119	85946	115	95202	83
60616	35	65210	42	73195	161	83140	119	85948	115	95203	83
60620	35	65212	42	73217	163	83150	119	85978	115	95301	84
60621	35	65213	42	73218	163	83180	121	85981	111, 116	95502	167
60622	35	65218	42	73233	157	83190	121	85995	115	95563	84
60623	35	65219	42	74002	161	83300	121	85996	115	95566	84
60624	35	65220	42	74004	161	83310	121	85997	115	95567	84
60626	35	65221	42	74015	162	83330	121	86013	111, 116	95660	84
61012	138	65222	42	74020	161	83340	121	86014	111, 116	95665	84
61501	37	65223	42	74048	161	83350	121	86097	110, 117	95925	162
61503	37	65225	42	74053	161	83393	121	86098	110, 117	96702	171
61505	37	65226	42	74078	162	83394	118	86099	110, 117	96705	79
61506	37	65231	42	75000	158	83405	118	86100	110, 117	99307	68
61507	37	65232	42	75060	158	83430	121	86101	110, 117	99346	72
61508	37	65233	42	75068	157	83440	121	86102	110, 117	99383	160
61509	37	65234	42	75085	154	83450	121	86103	110, 117	99551	68
61521	37	65235	42	75096	159	83513	119	86104	110, 117	99553	68
61523	37	65236	42	75097	159	83514	119	86105	110, 117	99554	86
61525	37	65238	42	75098	159	83515	119	86106	111, 116	99593	151
61526	37	65239	42	75102	159	83516	119	86107	111, 116	99594	154
61527	37	69850	35	75103	159	83550	121	86108	118	99694	84
61528	37	69851	35	75104	159	83630	121	86109	111, 116	99714	84
61529	37	69852	35	75105	159	83640	121	86110	111, 116	99786	84
61541	37	69853	35	75109	159	83715	119	86111	111, 116	99788	84
61543	37	69854	35	75110	159	83716	119	86112	114	99791	84
61545	37	69857	35	75117	160	83717	119	86113	114	99801	167
61546	37	69858	35	75118	160	83718	119	86114	114	99805	167
61547	37	69859	35	75130	159	83740	121	86115	114	99806	167
61548	37	69860	35	75131	159	83750	121	86116	114	99823	79
61549	37	69861	35	75132	159	83910	121	86117	114	99825	79
62002	36	69864	35	75133	160	83930	121	86120	118		
62003	36	69865	35	75137	160	83940	121	86121	114		
62004	36	69866	35	75138	160	83950	121	86122	114		
62005	36	69867	35	75140	159	83999	122	86123	118		
62006	36	69868	35	75160	152	84710	121	86124	118		
62007	36	69871	35	75170	159	84730	121	86125	114		
62008	36	69872	35	75171	159	84740	121	86126	118		
62012	36	69873	35	75172	159	84750	121	86127	118		
62013	36	69874	35	75173	159	84925	118	86128	118		
62014	36	69875	35	75180	159	84926	118	86129	118		
62015	36	69880	35	75181	159	84941	118	86130	118		
62016	36	69881	35	75182	159	85014	119	86131	118		
62017	36	69882	35	75202	154	85150	121	86132	118		
62018	36	69883	35	75505	151	85153	121	86133	118		
62022	36	69884	35	75516	150	85156	121	86134	118		
62023	36	69887	35	75525	150	85440	121	86135	118		
62024	36	69888	35	75527	150	84640	121	86136	118		
62025	36	69889	35	75528	150	85733	111, 116	86137	118		
62026	36	69890	35	75555	150	85736	111, 116	86138	118		
62027	36	69891	35	75570	158	85738	111, 116	86139	118		
62028	36	69894	35	77013	147	85750	111, 116	86140	118		
62032	36	69895	35	77014	147	85751	111, 116	86141	114		
62033	36	69896	35	79100	157	85752	111, 116	86142	114		
62034	36	69897	35	79101	157	85753	111, 116	86143	114		
62035	36	69898	35	79107	157	85773	111, 116	86148	124		
62036	36	69901	35	79109	157	85776	115	86150	112		
62037	36	69902	35	79120	157	85778	115	86151	112		
62038	36	69903	35	79251	162	85786	115	86152	112		
62052	36	69904	35	79252	162	85788	115	86154	112		
62053	36	69905	35	79253	162	85792	115	86155	112		
62054	36	70067	147	79255	162	85794	115	86156	112		
62055	36	70068	147	79256	162	85798	115	86159	124		
62056	36	70208	149	79800	67	85800	115	86160	124		
62057	36	70209	149	79801	67	85806	115	86165	120		



THE WEILER PROMISE

At Weiler, we passionately embrace change to improve our products and our processes to move the company and our customers forward. By bringing new ideas and creative problem solving together in an open, collaborative environment, we will improve our customers' productivity and create profitable growth.



WEILER ABRASIVES GROUP

Weiler Global HQ
One Weiler Drive
Cresco, PA 18326 USA

Weiler de México
Querétaro, México

Weiler do Brasil
São Paulo, Brazil

Weiler EMEA HQ
Maribor, Slovenia

Zreče, Slovenia

Loče, Slovenia

Oplotnica, Slovenia

Bindlach, Germany

800.835.9999 / weilerabrasives.com



Reorder No. WC244 - Fifth Edition / 81910PP / ©2019 Weiler Abrasives Group. All Rights Reserved.

