



CELEBRATING
45 YEARS



FOR OVER 45 YEARS, ONE WORD HAS DEFINED US... **INNOVATION.**

WHY STOP NOW?

Since 1973, Streamlight has delivered effective, efficient high-performance lighting solutions featuring the latest technology, unmatched performance, unheard of durability and incredible value. We've earned our reputation one customer at a time. And although features or light output may change – our commitment to quality and innovation is the one constant that will always remain the same.

STINGER SERIES

Stinger LED HL® Series	Pg. 10
Stinger® HPL Series	Pg. 11
Stinger® LED Series	Pg. 12
Ultrastinger® LED	Pg. 13
Stinger Switchblade® Series	Pg. 15
PolyStinger® Series	Pg. 16
Stinger Accessories	Pg. 17

RIGHT ANGLE SERIES

Survivor® Series	Pgs. 40-41
Vantage® II	Pg. 42
Vantage® 180 X Series	Pg. 43
Vantage®	Pg. 44
PolyTac 90®	Pg. 45
Knucklehead® Series	Pgs. 46-47

STRION SERIES

Strion LED HL® Series	Pg. 18
Strion® HPL Series	Pg. 20
Strion® LED Series	Pg. 20
Strion® Accessories	Pg. 21

SAFETY-RATED SERIES

Dualie® Series	Pgs. 52-55
Safety-Rated ProPolymer® Series	Pgs. 56-61
Knucklehead® HAZ-LO® Series	Pgs. 62-63
Safety-Rated Headlamps	Pgs. 64-65

SL SERIES

SL Series	Pgs. 22-23
-----------	------------

WEAPON-MOUNTED SERIES

TLR Series Full-Size Series	Pgs. 70-79
TLR Series Full-Size Accessories	Pgs. 80-81
TLR Sub-Compact Series	Pgs. 82-89
ProTac® Rail Mount Series	Pgs. 90-91

LANTERN SERIES

Portable Scene Light	Pg. 26
HiD LiteBox®	Pg. 27
Fire Vulcan® LED	Pg. 28
Vulcan® 180	Pg. 29
E-Flood® LiteBox® // E-Flood® FireBox®	Pg. 30
E-Spot® LiteBox® // E-Spot® FireBox®	Pg. 31
E-Flood HL® LiteBox® HL	Pg. 32
Lantern Accessories	Pg. 33
Waypoint® Series	Pgs. 34-35
Siege® Series	Pgs. 36-37

TACTICAL SERIES

ProTac® Series	Pgs. 94-105
PolyTac® Series	Pgs. 106-109
Super Tac® X // TL-2® X	Pg. 110
Scorpion® HL // Scorpion® X //	Pg. 111
NightFighter® X	Pg. 111
Sidewinder® Series	Pgs. 112-113



**HEADLAMP
SERIES**

Headlamp Series

Pgs. 114-127

**STYLUS
SERIES**

Stylus® Series
Stylus Reach® Series

Pgs. 128-133
Pgs. 134-135

**TWIN-TASK
SERIES**

Twin-Task® Series

Pgs. 136-138

**TASK-LIGHT
SERIES**

Task-Light® Series

Pg. 139

**SPECIALTY
SERIES**

Specialty Series

Pgs. 140-141

**STREAMLIGHT
JR. SERIES**

Streamlight Jr. F-Stop® Series
Streamlight Jr.® Series

Pg. 142
Pg. 143

**POCKET LIGHT
SERIES**

Pocket Lights

Pgs. 144-145

**LIGHTS FOR A CAUSE
SERIES**

Lights For A Cause

Pgs. 146-147



STREAMLIGHT®

// **STAY CONNECTED WITH US:**



LEADING THE INDUSTRY

WITH THE GREATEST VARIETY OF PROFESSIONAL GRADE LIGHTS:



STINGER DS LED HL® pg. 10 STINGER DS® HPL pg. 11 STINGER DS® LED pg. 12 ULTRASTINGER® LED pg. 13 STINGER SWITCHBLADE® pg. 15 **NEW** POLYSTINGER® LED HAZ-LO® pg. 16 POLYSTINGER DS® LED pg. 16



FIRE VULCAN® LED pg. 28 VULCAN® 180 pg. 29 E-FLOOD® LITEBOX® pg. 30 E-SPOT® LITEBOX® pg. 31 E-FLOOD® LITEBOX® HL pg. 32 WAYPOINT® pg. 34 WAYPOINT® RECHARGEABLE pg. 34



DUALIE® RECHARGEABLE MODELS pg. 53 **NEW** 2AA DUALIE® pg. 54 3AA DUALIE® MODELS pgs. 54-55 2AA PROPOLYMER® HAZ-LO® pg. 56 4AA PROPOLYMER® MODELS pgs. 57-58 3C PROPOLYMER® MODELS pgs. 58-59 3AA PROPOLYMER® HAZ-LO® pg. 60 3N PROPOLYMER® LED pg. 61



TLR-2® & TLR-2®s pg. 77 TLR IR™ LIGHTS pg. 78 TLR-VIR® LIGHTS pg. 79 TLR-6® MODELS pgs. 82-87 TLR-3® pg. 89 TLR-4® pg. 89 TLR-4® G pg. 89 PROTAC® RAIL MOUNT MODELS pgs. 90-91 PROTAC HL® 5-X USB pg. 95 **NEW**



PROTAC® 1AAA & 2AAA pg. 102-103 PROTAC® EMS pg. 103 18650 LI-ION BATTERIES & CHARGER pg. 105 EPU-5200™ (Light Not Included) pg. 105 POLYTAC® HP pg. 107 POLYTAC® pg. 107 POLYTAC® X USB pg. 109 **NEW**



BANDIT® MODELS pg. 118 **NEW** BANDIT® PRO MODELS pg. 119 **NEW** ENDURO® PRO MODELS pgs. 120-121 **NEW** ENDURO® pg. 121 DOUBLE CLUTCH™ USB pg. 122 PROTAC HL® & PROTAC HL® USB HEADLAMPS pgs. 104, 123



STYLUS PRO® USB MODELS pg. 130 STYLUS PRO® MODELS pg. 130 STYLUS PRO® 360 pg. 131 MICROSTREAM® MODELS pg. 132 STYLUS® MODELS pg. 133 STYLUS REACH® MODELS pgs. 134-135 TWIN-TASK® MODELS pgs. 136-138 TASK-LIGHT® 3AA pg. 139 MULTI OPS® pg. 140

STREAMLIGHT

PERFORMANCE. PERIOD.



STRION DS LED HL® pg. 18 STRION DS® HPL pg. 20 STRION DS® LED pg. 20 SL-20L® pg. 22 SL-20LP® pg. 23 PORTABLE SCENE LIGHT pg. 26 HID LITEBOX® pg. 27



DUALIE WAYPOINT® pg. 35 SUPER SIEGE® pg. 36 THE SIEGE® pg. 37 SIEGE® AA pg. 37 SURVIVOR® pg. 41 VANTAGE® II pg. 42 VANTAGE® 180 X USB pg. 43 VANTAGE® pg. 44 POLYTAC 90® pg. 45 KNUCKLEHEAD® FLOOD & SPOT MODELS pg. 47



KNUCKLEHEAD® HAZ-LO® MODELS pg. 63 HAZ-LO® HEADLAMPS pgs. 64-65 TLR-8® pg. 70 TLR-7® pg. 71 TLR-1 HL® & TLR-2 HL® pg. 73 TLR-2 HL® G pg. 73 TLR-1 HPL® pg. 74 TLR-1® GAME SPOTTER® pg. 75 TLR-2® G pg. 76 TLR-1® S pg. 77



PROTAC® HL-X USB pg. 96 PROTAC® 2L-X USB pg. 96 PROTAC HL® 4 pg. 97 PROTAC® HPL USB pg. 98 PROTAC HL® USB pg. 98 PROTAC HL® 3 pg. 99 PROTAC HL® pg. 99 PROTAC® 1L-1AA pg. 100 PROTAC® 1L & 2L pg. 101 PROTAC® 2AA pg. 102



SUPER TAC® X pg. 110 TL-2® X pg. 110 SCORPION® HL pg. 111 SCORPION® X pg. 111 NIGHTFIGHTER® X pg. 111 SIDEWINDER® MODELS pg. 112 SIDEWINDER® RESCUE pg. 112 SIDEWINDER COMPACT® II MODELS pg. 113



ARGO® MODELS pg. 124 SEPTOR® MODELS pg. 125 3AA HAZ-LO® pg. 125 TRIDENT® MODELS pg. 126 TWIN-TASK® USB HEADLAMP pg. 127 TWIN-TASK® 3AA HEADLAMP pg. 127



NIGHT COM® MODELS pg. 141 STREAMLIGHT JR. F-STOP® pg. 142 STREAMLIGHT JR.® LED MODELS pg. 143 CLIPMATE® USB pg. 144 KEYMATE® USB pg. 145 CLIPMATE® pg. 145 THE LOGO™ pg. 145 NANO LIGHT® pg. 146



OUR 18650. THE BATTERY THAT REINVENTS RECHARGEABILITY.



**THE 18650 THAT TURNS HIGH-PERFORMANCE LIGHTS
INTO RECHARGEABLE SYSTEMS.**

You know how you make the best performing, brightest lights in the business even better? Simple. Give users multiple ways to power and charge them. Introducing our 18650 USB battery with integrated charging port. Charges by USB cord, in our traditional charge cradle or from our EPU-5200. Flexibility for however and wherever you use your light.

RECHARGEABLE 18650 SYSTEMS AVAILABLE IN 5 POPULAR KITS



VANTAGE 180® X USB



POLYTAC® X USB



PROTAC® HL-X USB



PROTAC HL® 5-X USB



PROTAC® 2L-X USB

DIRECT CHARGE WITH USB CORD

Charge from wall charger, truck USB outlet, laptop or desktop computer, your TV's USB port – wherever your job takes you, you'll have the ability to charge.



CHARGING



CHARGED

USB Rechargeable 2600mAh 18650
Lithium Ion Battery – Charges in 5 hours.
Featuring charge status indicator.

DIRECT CHARGE FROM 18650 CRADLE

The charger features dual input power sources, accepting either 5V USB power or traditional AC or 12V DC power sources.



EASILY CHARGES FROM EPU-5200™

Take your power and rechargeability anywhere.



STINGER & STRION

SERIES //



DUTY & UTILITY LIGHTING SPECIALISTS

BECAUSE WORK IS TOUGH ENOUGH WITHOUT HAVING TO WORRY ABOUT YOUR LIGHTING.

Streamlight Stingers, Strions and SL lights are trusted by LEQ, professional mechanics and tradesmen around the world for a simple reason... they're the best. With the performance and features that they need and the durability they can depend on.

STINGER SWITCHBLADE®



STINGER DS® HPL LED



STRION DS LED HL®



STINGER DS LED HL®

STINGER DS LED HL®
STINGER LED HL®

Everything you love about the Stinger with more lumens for more brightness and a wider beam that lights up a whole area from side to side. Now you'll see the dangers that may be hiding in corners in rooms, tunnels, alleyways, cars, and more.

STINGER DS LED HL

BATTERY: NiMH Rechargeable

DS SIZE: 8.85" x 1.62" x 1.17"
(22.48 x 4.11 x 2.97 cm)

DS WEIGHT: 12.8 OZ (364 g)

COLOR: Black

STINGER LED HL

BATTERY: NiMH Rechargeable

SIZE: 8.41" x 1.62" x 1.17"
(21.36 x 4.11 x 2.97 cm)

WEIGHT: 12.4 OZ (352 g)

COLOR: Black

DS LED HL LED HL

75454	75430	with 120V AC/12V DC - 2 holders (NiMH)-Black
75455	75431	with 120V AC (NiMH)-Black
75456	75432	with 12V DC (NiMH)-Black
75458	75434	with 120V AC/12V DC - 1 PiggyBack (NiMH)-Black
75453	75429	without Charger (NiMH)-Black

	HIGH	MEDIUM	LOW
LUMENS:	800	400	200
CANDELA:	24,000	12,000	6,000
DISTANCE:	310m	216m	155m
RUN TIME:	1h 30m	2h 30m	5h

Strobe mode: 3 hours of continuous run time

800 LUMENS HL SERIES



With **[(STROBE)]**
Double tap switch to activate.

AVAILABLE IN BOTH DUAL SWITCH AND STANDARD STYLES

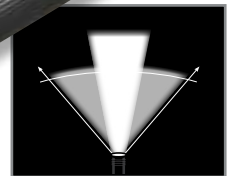

HLSERIES

**DIFFERENT KINDS OF BEAMS
FOR DIFFERENT KINDS OF TASKS.**

WANT TO SEE THESE BEAMS IN ACTION?
Visit Streamlight's www.beamdemo.com
and see the differences for yourself.

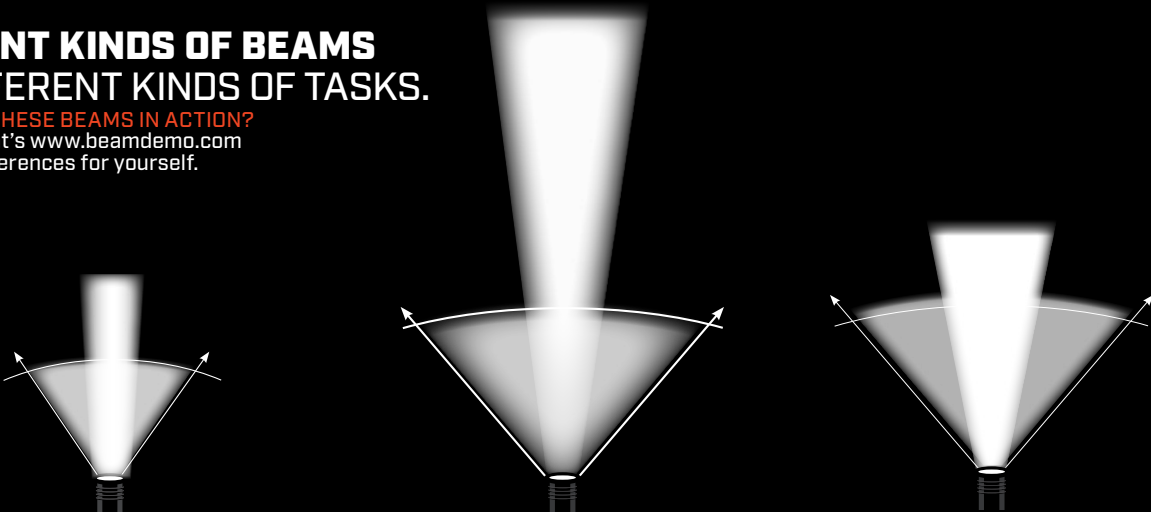

TRADITIONSERIES

This family of flashlights delivers the optimal balance of bright, far-reaching beam, ample peripheral light, and long run times. When you're out in the field or on any job that requires light for long periods, these are the flashlights you want by your side. Their brightness, power, performance, cost, and extended run times make them perfect for a variety of tasks.

HPLSERIES

These High Performance, High Lumen flashlights throw bright light a long distance. They have a bigger hot spot that casts more light on the target with more peripheral light. They're great for illuminating the entire length of a dark alley, for any task that requires a far-reaching beam.

HLSERIES

These High Lumen flashlights have a wide, side-to-side beam. They illuminate an entire area, including what may be hiding in corners. They perform like floodlights, illuminating a whole room, vehicle, or any area with bright, revealing light.

THE STINGER SERIES IS ALWAYS ON THE JOB.

IT'S A DUTY LIGHT. BUILT WITH PRECISION & PERFORMANCE.



**STINGER
DUTY+TACTICAL
HOLSTER**

DUTY + TACTICAL HOLSTER
- Super-tough nylon construction
- Quick, Easy Access

STINGER DS® HPL LED **STINGER® HPL LED**

The Stinger® HPL has combined two intensely bright illumination patterns into one multi-tasking beam giving you clarity up-close and deep into the horizon. Its long distance beam reaches 438 meters and the 800 lumen beam provides side to side visibility to fill in up-close areas and corners.

STINGER DS HPL LED

BATTERY: NiMH Rechargeable
DS SIZE: 9.65" x 2.20" x 1.17"
(24.51 x 5.59 x 2.97 cm)
DS WEIGHT: 14.0 oz (396 g)
COLOR: Black

STINGER HPL LED

BATTERY: NiMH Rechargeable
SIZE: 9.23" x 2.20" x 1.17"
(23.44 x 5.59 x 2.97 cm)
WEIGHT: 13.6 oz (385 g)
COLOR: Black

DS HPL	HPL	
75863	75763	with 120V AC/12V DC - 2 holders (NiMH)
75861	75761	with 120V AC (NiMH)
75899	75799	with 12V DC (NiMH)
75882	75782	with 120V AC/12V DC - 1 PiggyBack (NiMH)
75900	75980	without Charger (NiMH)

	HIGH	MEDIUM	LOW
LUMENS:	800	400	200
CANDELA:	48,000	24,000	12,000
DISTANCE:	438m	310m	219m
RUN TIME:	1h 30m	2h 30m	5h

Strobe mode: 3 hours of continuous run time

800 LUMENS HPL SERIES



With **[(STROBE)]**
Double tap switch to activate.

AVAILABLE IN BOTH DUAL SWITCH AND STANDARD STYLES

SEE **STINGER ACCESSORIES** P. 17



THE STINGER IS FOUND
IN MORE TOOL BOXES
AND HOLSTERS FOR TWO SIMPLE REASONS...
PERFORMANCE AND DEPENDABILITY.

STINGER DS® LED
STINGER® LED

The Stinger LED and Stinger DS LED deliver the optimal balance of performance and value with the longest run time in the Stinger family. The DS model provides both a tailcap and head switch.

STINGER DS LED

BATTERY: NiMH Rechargeable

DS SIZE: 8.85" x 1.62" x 1.17"
(22.48 x 4.11 x 2.97 cm)

DS WEIGHT: 12.8 oz (364 g)

COLOR: Black

STINGER LED

BATTERY: NiMH Rechargeable

SIZE: 8.41" x 1.62" x 1.17"
(21.36 x 4.11 x 2.97 cm)

WEIGHT: 12.4 oz (352 g)

COLOR: Black

DS LED LED

75813	75713	with 120V AC/12V DC Smart Charger—Black
75811	75711	with 120V AC Smart Charger—Black
75832	75732	w/120V AC/12V DC PiggyBack®—Black
75853	75753	with 12V DC Smart Charger (NiMH)—Black
75810	75710	without Charger (NiMH)—Black

	HIGH	MEDIUM	LOW
LUMENS:	425	200	100
CANDELA:	26,000	12,000	6,000
DISTANCE:	322m	219m	155m
RUN TIME:	3h	5h 30m	10h

Strobe mode: 7.5 hours of continuous run time

425 LUMENS TRADITION SERIES



With **[(STROBE)]**
Double tap switch to activate.

AVAILABLE IN BOTH DUAL SWITCH AND STANDARD STYLES



**FAR REACHING BEAM +
1,100 LUMENS...
THERE'S A REASON IT'S CALLED THE
ULTRASTINGER LED.**

ULTRASTINGER® LED

The UltraStinger LED delivers a piercing 1,100 lumens, but that's not all... it also has a far-reaching beam, TEN-TAP® programming for its multiple intensities and strobe; plus we added a rubber sleeve for a better grip. It's IPX4 rated for water resistance and it works with existing Stinger® chargers and accessories.

ULTRASTINGER LED

BATTERY: NiMH Rechargeable

SIZE: 11.82" x 2.37" x 1.19" (30 x 6.01 x 3 cm)

WEIGHT: 19.9 oz (564 g)

COLOR: Black

- 77553 with AC/DC Smart Charger—Black
- 77551 with AC Smart Charger—Black
- 77555 with DC Smart Charger — Black
- 77550 without Charger—Black

	HIGH	MEDIUM	LOW
LUMENS:	1,100	350	90
CANDELA:	65,000	21,000	5,000
DISTANCE:	510m	290m	141m
RUN TIME:	1h 30m	4h 30m	16h

Strobe mode: 3h 15m of continuous run time

1,100 LUMENS HL SERIES



TEN-TAP® programmable switch allows user selection of one of three different programs:

- High/medium/low with strobe (factory default)
- High only without strobe
- High/medium/low without strobe

With **[(STROBE)]**

Double tap switch to activate.

HLSERIES

THE STINGER SWITCHBLADE
SPENDS AS MUCH TIME
**UNDER THE CAR,
ON THE WALL,
AND COVERED
IN GREASE**

AS YOU DO. A PERFECT MATCH.



STINGER SWITCHBLADE®

Compact and extremely powerful, the Stinger Switchblade® rechargeable area light offers three (3) lighting options. The blade of the Switchblade can rotate 180° on the body. Soft dents will hold the blade in your desired position, and the light will stand on its tail with the light bar in any position. There are multiple ways to hook and hang the light. Use the hooks on the base plate or the retractable hook for many hanging options. The weighted base also includes magnets that will hold the light (in any orientation) to provide task-specific illumination.



NEW

	COOL WHITE	90 CRI	UV LED
OUTPUT:	800 Lumens	600 Lumens	500 mW
RUN TIME:	3h 45m	3h 45m	15h

STINGER SWITCHBLADE

BATTERY: Lithium Ion Rechargeable

FOLDED SIZE: 9.80" x 1.62" x 1.40" (24.89 x 4.11 x 3.56 cm)

EXTENDED LENGTH: 17.0" (43.18 cm)

WEIGHT: 17.1 OZ (485 g)

COLOR: Red

76801 120V/100V AC 1 holder – Red

76800 with USB cord – Red



DOUBLE-SIDED LIGHT BAR:

- 1.) 90 CRI LEDs - Color-Rite Technology - allows you to distinguish between similar colors - for paint matching, checking wires, etc.
- 2.) Cool white LEDs for bright, white light
- 3.) UV LED for leak detection



DUAL CHARGING OPTIONS:
CHARGE USING EXISTING STINGER CHARGERS OR CHARGE VIA USB SOURCE



180° rotating light bar aims the beam where you need it.



HANDS-FREE APPLICATIONS:
TAIL-END MAGNET. STOWABLE HANG HOOK AND STABLE FOOT

BUILT FOR DURABILITY AND PERFORMANCE.

POLYSTINGER® LED HAZ-LO®

If you're working in a potentially hazardous location, this is the light you need. It provides lots of bright, white light, yet it's intrinsically safe, with a Class I, Div. 1. rating. It has an O-ring sealed, unbreakable, scratch-resistant lens. It's IPX4 rated for water-resistance, and 3 meter impact-resistance tested.

	HIGH	LOW
LUMENS:	130	50
CANDELA:	15,000	5,700
DISTANCE:	245m	151m
RUN TIME:	4h	12h

Moonlight mode: 20 days of continuous run time



Lanyard Ring with lanyard for tail cap.

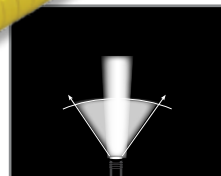

TRADITION SERIES

POLYSTINGER LED HAZ-LO
BATTERY: NiCd Rechargeable
SIZE: 10.2" x 1.76" x 1.34"
(25.9 x 4.47 x 3.4 cm)
WEIGHT: 13.5 oz (382 g)
COLOR: Black or Yellow



Class I & II, Division 1, Groups C,D,F,G;
Class I, Division 2, Groups A,B,C,D;
Class III; 138 C, T-Code: T3C

YELLOW BLACK

76412	76442	120V AC/12V DC Smart Charger
76411	76441	12V DC Smart Charger
76410	76440	Without Charger

ACCESSORIES

76409	Lanyard
75928	Loop Holster
75906	Ring Holder
76375	NiCd Battery Stick
75400	5 Unit Bank Smart Charger 120V
22060	120V AC Charge Cord
22051	DC1 Charge Cord
22050	DC2 Direct Wire Charge Cord

POLYSTINGER DS® LED POLYSTINGER® LED

Intense brightness, long-range and long run time in a durable nylon polymer housing. It's the ideal combination of power, performance and durability. The DS model has the convenience of two full-function, independent switches: one on the head and a tail switch.

	HIGH	MEDIUM	LOW
LUMENS:	485	240	120
CANDELA:	28,000	14,000	7,000
DISTANCE:	335m	237m	167m
RUN TIME:	3h	5h 30m	10h

Strobe mode: 7.5 hours of continuous run time



TRADITION SERIES

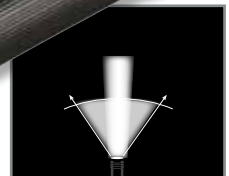

TRADITION SERIES



With **[(STROBE)]**
Double tap switch to activate.

AVAILABLE IN BOTH DUAL SWITCH AND STANDARD STYLES

POLYSTINGER DS LED

BATTERY: NiMH Rechargeable
DS SIZE: 8.64" x 1.76" x 1.21"
(21.95 x 4.47 x 3.07 cm)
DS WEIGHT: 11.9 oz (338 g)
DS COLOR: Black



POLYSTINGER LED

BATTERY: NiMH Rechargeable
SIZE: 8.07" x 1.76" x 1.21"
(20.50 x 4.47 x 3.07 cm)
WEIGHT: 11.5 oz (326 g)
COLOR: Black or Yellow

DS LED	LED	
—	76163	120V AC/DC 2 Holders—Yellow
76813	76113	120V AC/DC 2 Holders—Black
—	76161	120V AC—Yellow
76811	76111	120V AC—Black
—	76199	12V DC—Yellow
76849	76149	12V DC—Black
—	76182	120V AC/DC 1 PiggyBack Holder—Yellow
76832	76132	120V AC/DC 1 PiggyBack Holder—Black
—	76203	Without Charger—Yellow
76850	76150	Without Charger—Black

STINGER ACCESSORIES

At Streamlight, we engineer the highest performing, most rugged, durable and innovative lights on the market. In addition, we support them with the accessories you can depend on and the options and configurations that you need to accommodate all your portable lighting needs.

Stinger Accessories	DS LED HL LED HL	DS HPL HPL	DS LED LED	UltraStinger LED	Stinger Switchblade	PolyStinger LED HAZ-LO	PolyStinger LED / DS LED
5 Unit Bank Charger 	75400	75400	75400	75400	75400	75400	75400
Smart Charger 	75105	75105	75105	75105	75105	75105	75105
Steady Piggyback® 	75277	75277	75277	—	—	75277	75277
NiCd Battery Stick 	—	—	—	—	—	76375	—
NiMH Battery Stick 	75375	75375	75375	77375	—	—	75375
Li-Ion Battery Stick 	75176	75176	75176	75176	76805	—	75176
12V Cig Charge Cord 	22051	22051	22051	22051	22051	22051	22051
12V DC Charge Cord 	22050	22050	22050	22050	22050	22050	22050
120V AC Charge Cord 	22071	22071	22071	22071	22071	22071	22071
Leather Plain Holster 	75133	—	75133	—	—	—	75133
Leather Weave Holster 	75134	—	75134	—	—	—	75134
Std. Nylon Holster 	75927	75927	75927	—	—	—	75910
Loop Nylon Holster 	75928	75928	75928	75928	—	75928	75928
Duty Holster 	88053	88053	88053	88053	—	—	—
Ring Holder 	75906	75906	75906	75906	—	75906	75906
Red Flip Lens 	75115	—	75115	—	—	—	—
Green Flip Lens 	75117	—	75117	—	—	—	—
Blue Flip Lens 	75116	—	75116	—	—	—	—
Red Wand 	75903	75946	75903	78903	—	—	75933
White Wand 	75908	75949	75908	78908	—	—	75938
Blue Wand 	75902	75947	75902	—	—	—	75932
Yellow Wand 	75904	75948	75904	78904	—	—	75934
Glow Wand 	75913	75950	75913	78913	—	—	75943
USB Cord - 5" 	22079	22079	22079	—	22079	—	—
USB Cord - 22" 	22070	22070	22070	—	22070	—	—
USB Cord - 40" 	22081	22081	22081	—	22081	—	—
12V DC USB Adapter 	22069	22069	22069	—	22069	—	—
100V/120V AC USB Adapter 	22058	22058	22058	—	22058	—	—

THE STRION SERIES. SMALL FORM FACTOR, BIG PERFORMANCE.

STRION DS LED HL® STRION LED HL®

The power of a Stinger in a more compact Lithium Ion rechargeable flashlight. It even fits long-gun mounts. Casts a bright white beam that spreads out to illuminate an entire area. You'll see what's in front of you and what may be hiding in the corners.

STRION DS LED HL

BATTERY: Li-ion Rechargeable
SIZE: 6.33" x 1.25" x .95"
(16.08 x 3.18 x 2.41 cm)
WEIGHT: 5.4 oz (153 g)
COLOR: Black

STRION LED HL

BATTERY: Li-ion Rechargeable
SIZE: 5.90" x 1.25" x .95"
(14.99 x 3.18 x 2.41 cm)
WEIGHT: 5.2 oz (148 g)
COLOR: Black

DS HL	LED HL	
74612	74752	with 120V AC/12V DC - 2 holders-Black
74611	74751	with 120V AC/12V DC - 1 holder-Black
74621	74755	with 120V AC/12V DC - 1 holder-Black-Clam
74619	74778	with 120V AC/12V DC - 1 PiggyBack-Black
74613	74753	with 120V AC
74614	74754	with 12V DC
74610	74750	without Charger-Black
74620	74509	Strion LED HL with grip ring - with 120V AC

STRION HL	HIGH	MEDIUM	LOW
LUMENS:	615	320	160
CANDELA:	12,000	6,000	3,000
DISTANCE:	219m	155m	110m
RUN TIME:	1h 15m	2h 30m	4h 30m

Strobe mode: 3 hours of continuous run time

HL® **Dual Switch** TECHNOLOGY With **[(STROBE)]**
Double tap switch to activate.
AVAILABLE IN BOTH DUAL SWITCH AND STANDARD STYLES

ds700LUMENS HL SERIES



STRION DS HL	HIGH	MEDIUM	LOW
LUMENS:	700	300	40
CANDELA:	12,000	5,000	800
DISTANCE:	219m	141m	57m
RUN TIME:	1h 15m	3h 30m	24h

Strobe mode: 2.5 hours of continuous run time

DS model features **TEN-TAP**® programmable switch that allows user selection of one of three different programs:

- High/medium/low with strobe (factory default)
- High only without strobe
- High/medium/low without strobe



**STRION DS® LED HPL
STRION® LED HPL**

Lightweight and ultra-compact, yet extremely powerful. It throws its long beam far out in the distance while casting plenty of peripheral light along the way. Features three intensities plus strobe. Rechargeable battery and powerful illumination result in one of the lowest operating costs of any flashlight. Easy, one-handed operation with multi-function push-button tailswitch.

STRION DS LED HPL

BATTERY: Li-ion Rechargeable
SIZE: 7.56" x 2.2" x .95"
(19.2 x 5.59 x 2.41 cm)
WEIGHT: 6.9 oz (196 g)
COLOR: Black

STRION LED HPL

BATTERY: Li-ion Rechargeable
SIZE: 7.00" x 2.2" x .95"
(17.78 x 5.59 x 2.41 cm)
WEIGHT: 7.1 oz (202 g)
COLOR: Black

DS HPL	HPL	
74811	74501	with 120V AC/12V DC – 1 Holder – Black
74812	74502	with 120V AC/12V DC – 2 Holders – Black
74819	74536	with 120V AC/12V DC – 1 PiggyBack
74813	74503	with 120V AC – Black
74814	74504	with 12V DC – Black
74810	74500	without Charger – Black

**STRION DS® LED
STRION® LED**

A powerful value that's perfect for the broadest range of lighting needs. IPX4 rated for water-resistance. Anti-roll ring included. Optional model with adjustable Grip Ring provides a sure-grip for easy one-handed operation.

STRION DS LED

BATTERY: Li-ion Rechargeable
SIZE: 6.4" x 1.25" x .95"
(16.26 x 3.18 x 2.41 cm)
WEIGHT: 5.4 oz (153 g)
COLOR: Black

STRION LED

BATTERY: Li-ion Rechargeable
SIZE: 5.9" x 1.25" x .95"
(14.99 x 3.18 x 2.41 cm)
WEIGHT: 5.2 oz (148 g)
COLOR: Black or Pink

DS	STRION	
74411	74301	with 120V AC/12V DC – 1 Holder – Black
74412	74302	with 120V AC/12V DC – 2 Holders – Black
74413	74303	with 120V AC – Black
74414	74304	with 12V DC – Black
74421	74308	with 120V AC/12V DC – Black – Clam
74419	74353	with 120V AC/12V DC – 1 PiggyBack – Black
–	74361	with 120V AC/12V DC – 1 PiggyBack – Pink
74410	74300	without Charger – Black
74420	74309	with Grip Ring 120V AC – Black
–	74350	with 120V AC/12V DC – 1 Holder – Pink

STRION HPL	HIGH	MEDIUM	LOW
LUMENS:	615	320	160
CANDELA:	40,000	20,000	10,000
DISTANCE:	400m	283m	200m
RUN TIME:	1h 15m	2h 30m	4h 30m

Strobe mode: 3 hours of continuous run time

615 LUMENS

HPL SERIES



HPL SERIES

ds700 LUMENS

DS model features **TEN-TAP®** programmable switch allows user selection of one of three different programs:

- High/medium/low with strobe (factory default)
- High only without strobe
- High/medium/low without strobe

Dual Switch TECHNOLOGY With **[(STROBE)]**
Double tap switch to activate.
AVAILABLE IN BOTH DUAL SWITCH AND STANDARD STYLES

STRION DS HPL	HIGH	MEDIUM	LOW
LUMENS:	700	300	40
CANDELA:	44,000	18,000	2,600
DISTANCE:	420m	268m	102m
RUN TIME:	1h 15m	3h 30m	24h

Strobe mode: 2.5 hours of continuous run time

STRION	HIGH	MEDIUM	LOW
LUMENS:	375	175	80
CANDELA:	12,000	6,500	3,200
DISTANCE:	219m	161m	113m
RUN TIME:	2h 30m	4h 45m	9h 30m

Strobe mode: 6.5 hours of continuous run time

375 LUMENS

TRADITION SERIES



TRADITION SERIES

ds375 LUMENS

DS model features **TEN-TAP®** programmable switch allows user selection of one of three different programs:

- High/medium/low with strobe (factory default)
- High only without strobe
- High/medium/low without strobe

Dual Switch TECHNOLOGY With **[(STROBE)]**
Double tap switch to activate.
AVAILABLE IN BOTH DUAL SWITCH AND STANDARD STYLES

STRION DS	HIGH	MEDIUM	LOW
LUMENS:	375	150	40
CANDELA:	12,000	5,000	1,300
DISTANCE:	219m	141m	72m
RUN TIME:	2h 30m	6h 15m	24h

Strobe mode: 5 hours of continuous run time

REDUCE DOWNTIME

WHEN YOU DOUBLE THE BATTERIES YOU HAVE ON HAND.



**STRION®
PIGGYBACK
CHARGER**

STRION PIGGYBACK CHARGER – 74115

- Always Be Ready
- Charge via 12V DC, 120 AC or USB
- Quick, and Convenient
- Charges Light & Spare Battery

STRION ACCESSORIES

Strion Accessories	STRION / DS LED HL	STRION HPL / DS HPL	STRION / STRION DS
 6 Unit Bank Charger 120V	74400	74400	74400
 6 Unit Bank Charger DC	74401	74401	74401
 Piggyback Charger Holder	74115	74115	74115
 Smart Charger Holder	74102	74102	74102
 Li-ion Battery Stick	74175	74175	74175
 12V Cig Charge Cord	22051	22051	22051
 12V DC Charge Cord	22050	22050	22050
 120V USB Charge Cord	22071	22071	22071
 Rail Mount	74200	74200	74200
 Vertical Grip	69114	69114	69114
 Leather Plain Holster	74059	–	74059
 Leather Weave Holster	74060	–	74060
 Std. Nylon Holster	–	75910	–
 Nylon Option Holster	85905	–	85905
 Tactical Holster	88051	88051	88051
 Red Flip Lens	85115	–	85115
 Green Flip Lens	85117	–	85117
 Blue Flip Lens	85116	–	85116
 Red Wand	74903	75946	74903
 White Wand	–	75949	–
 Blue Wand	–	75947	–
 Yellow Wand	74904	75948	74904
 Glow Wand	74913	75950	74913



SL-20L®

Full-size, professional grade light that delivers the intense brightness and run times you need for a wide variety of jobs.

SL-20L

BATTERY: NiMH Rechargeable

SIZE: 13.1" x 2.5" x 1.5"
(33.3 x 6.35 x 3.81 cm)

WEIGHT: 1 lb 11.2 oz (770 g)

COLOR: Black

20703	with 120V AC/DC-Smart Charge - 2 Sleeves - Black
20701	with 120V AC Smart Charge - Black
20702	with 12V DC Smart Charge - Black
20700	without Charger - Black

	HIGH	MEDIUM	LOW
LUMENS:	350	160	10
CANDELA:	60,000	27,000	1,000
DISTANCE:	490m	329m	63m
RUN TIME:	2h	4h	50h

Strobe mode: 4 hours of continuous run time

With **[(STROBE)]**
Double tap switch to activate.



Special Features:

- Unbreakable, scratch-resistant, O-ring sealed lens.
- IPX4 rated for water-resistance.
- 1 meter impact-resistance tested.

SL ACCESSORIES



	5 Unit Bank Charger 120v	5 Unit Bank Charger DC	Charger Sleeve	12V Cig Charge Cord	12V DC Charge Cord	120V AC Charge Cord
SL-20L	21400	21401	22052	22051	22050	22060
SL-20LP	21400	21401	22052	22051	22050	22060

A HISTORY OF PERFORMANCE, THE LEGENDARY FULL-SIZE DUTY LIGHT.



SL-20LP®

All the power and performance of our SL-20L® in a durable, nylon polymer lightweight housing.

SL-20LP

BATTERY: NiMH Rechargeable

SIZE: 13.2" x 2.5" x 1.5"
(33.5 x 6.35 x 3.81 cm)

WEIGHT: 1.3 lb (590 g)

COLOR: Black, Yellow or Orange

25323	with 120V AC/12V DC Smart Charge - 2 Sleeves - Yellow
25303	with 120V AC/12V DC Smart Charge - 2 Sleeves - Black
25313	with 120V AC/12V DC Smart Charge - 2 Sleeves - Orange
25321	with 120V AC Smart Charge - Yellow
25301	with 120V AC Smart Charge - Black
25311	with 120V AC Smart Charge - Orange
25322	with 12V DC Smart Charge - Yellow
25302	with 12V DC Smart Charge - Black
25312	with 12V DC Smart Charge - Orange
25320	without Charger - Yellow
25300	without Charger - Black
25310	without Charger - Orange

With **[(STROBE)]**
Double tap switch to activate.

	HIGH	MEDIUM	LOW
LUMENS:	350	160	10
CANDELA:	60,000	27,000	1,000
DISTANCE:	490m	329m	63m
RUN TIME:	2h	4h	50h

Strobe mode: 4 hours of continuous run time

Special Features:

- Unbreakable, scratch-resistant, O-ring sealed lens.
- IPX4 rated for water-resistance.
- 1 meter impact-resistance tested.



	NiMH Battery Stick	Ring Holder	Std. Nylon Holster	Red Wand	White Wand	Blue Wand	Yellow Wand	Glow in the Dark Wand
SL-20L	77375	22911	25090	22511	22517	22512	22519	22513
SL-20LP	77375	22911	25090	22511	22517	22512	22519	22513



LANTERN
SERIES //

LANTERN SERIES

FROM FIRST ON THE SCENE TO THE LAST ONE OUT OF THE TUNNEL, HEROES TRUST STREAMLIGHT.

Lanterns are part of our history and part of our future. In 1973, Streamlight pioneered portable lighting with our million candlepower SL and for the past 45+ years we continue to forge new ways to provide light where it's needed.



PORTABLE
SCENE LIGHT



VULCAN® 180



DUALIE WAYPOINT®



THE SIEGE® LANTERN

LIGHT UP THE WORLD ANYWHERE YOU WANT.

PORTABLE SCENE LIGHT

The Portable Scene Light provides rapid deployment on site, and it goes anywhere. With its 90° swivel neck, it's easy to shine light into the most out-of-the-way place. The head extends to 72" within seconds. It provides 3 levels of lighting and substantial run time to last through several shifts, even days. The unique diffuser lets you select a flood or spot beam in all three levels. It's designed to adapt to tight spaces, but rugged enough to be stable in wide open terrain or steps. The regulated light provides consistent output throughout the life of the battery. It's an indispensable tool for first responders, construction crews, and utility workers.

PORTABLE SCENE LIGHT

BATTERY: Zero-maintenance, sealed lead acid. Can also be powered by 12V DC power cord.

SIZE: 22" x 6.5" x 11" (55.88 x 16.5 x 27.9 cm)

WEIGHT: 25 lb (11.3 kg)

COLOR: Yellow

PORTABLE SCENE LIGHT

45670 120V AC/12V DC Portable Scene Light – Yellow

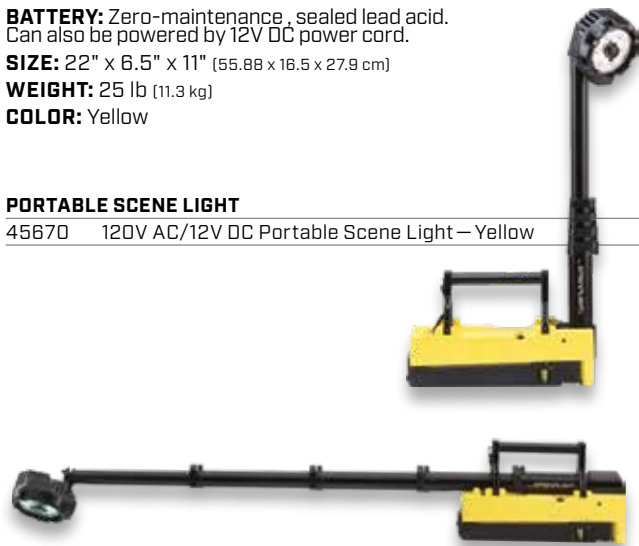

	HIGH	MEDIUM	LOW
LUMENS:	5,300	2,500	1,300
CANDELA:	42,000	21,300	11,600
DISTANCE:	410m	292m	215m
RUN TIME:	4h	9h	18h

5,300 LUMENS HL SERIES



Full extension to 72" with the stabilization legs fully deployed and locked in less than 30 seconds

Cord is built into the pole avoiding snags during deployment

Balanced design; lead acid batteries provide ballast and stability

Special Features:

- Full deployment in 30 seconds
- Pole extends to 72"; cord built into the pole to avoid snags
- Stabilization legs provide balance on uneven surfaces



THE HID LITEBOX:
**THE POWER
TO LIGHT AN
ENTIRE SCENE.**

HID LITEBOX®

This portable, one million candela searchlight illuminates objects up to a mile away. Its 35-watt, high intensity xenon lamp has a 2,000-hour minimum lifetime and a 90° swivel head. The intense brightness and amazing 1-mile reach make this the ideal hand-held light when you absolutely must be able to inspect an entire area quickly and efficiently. It plugs into your vehicle's power source for an unlimited run time.

HID LITEBOX

BATTERY: Zero-maintenance, sealed lead acid

SIZE: 14.9" x 5.1" x 8.8"
(38 x 13 x 23 cm)

WEIGHT: 10 lbs 1.6 oz (4.6 kg)

COLOR: Orange or Black

ORANGE BLACK

45601	45621	w/ 120V AC/12V DC includes shoulder strap and flood lens
45600	45620	without Charger includes shoulder strap and flood lens
45605	45625	Vehicle Mount System with 12V DC — includes shoulder strap and flood lens



	HIGH
LUMENS:	3,350
CANDELA:	1,000,000
RUN TIME:	1h 45m



10 ft (3 meters) 12V DC power cord plugs into port at rear of light to provide duration lighting

HID LiteBox battery will continue to charge while operating directly from an external 12V DC power source when using the remote cord



Swivel neck shown in 90° position.

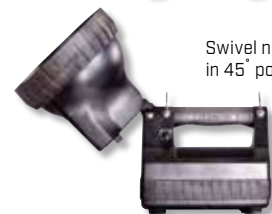

Swivel neck shown in 45° position.



The Fire Vulcan and Vulcan 180 feature blue taillight LEDs for rear visibility.

SEE AND BE SEEN EVEN IN THE THICKEST SMOKE

THE VULCAN SERIES FEATURE A TIGHT BEAM AND
BLUE TAILLIGHT LEDs

FIRE VULCAN® LED

This lightweight lantern with taillight LEDs helps you be seen even in thick smoke. It's IPX7 rated for water resistance to 1 meter for 30 minutes. It even floats! Delivers regulated, consistent light throughout battery life. The light modes are programmable, so you can control the order in which the modes come on. Features an unbreakable, scratch-resistant, O-ring sealed lens.

FIRE VULCAN LED

BATTERY: Lithium-ion Rechargeable

SIZE: 7.5" x 5" x 6.5"
(19.05 x 12.7 x 16.51 cm)

WEIGHT: 1.85 lbs (839 g)

COLOR: Orange

44450 Standard System with 120V AC/12V DC—Orange

44451 Vehicle Mount with 12V DC—Orange

44454 without Charger—Orange



Class I, Div. 2, Groups A, B, C, D;
Class II, Div. 2, Groups F, G;
Class III T-Code: T4

NFPA

Rack meets requirements
of NFPA 1901-14.1.10.2
(2016) mounted in
any position

	HIGH	LOW
LUMENS:	180	80
CANDELA:	100,000	45,000
RUN TIME:	5h	10h



Ultra-bright blue taillight LEDs make certain you can be seen, even in thick smoke.

TWO FIRE VULCAN® LED MODELS:

Standard System: Includes charging rack and both AC and DC chargers.

Vehicle Mount System: Includes 12V DC vehicle-mountable, direct-wire charging rack.

THE VULCAN SERIES ARE MULTI-FUNCTION LANTERNS.

VULCAN® 180

The lightest portable lantern of its kind, the Vulcan 180 is designed to burn brighter and run longer making it an essential firefighting tool. This rechargeable, waterproof lantern has a 180° tilting head which allows you to direct the light where you need it. Three LEDs bring you extreme brightness along with two blue taillight LEDs for visibility in thick smoke.

VULCAN 180

BATTERY: Lithium-ion Rechargeable

SIZE: 7.43" x 4.32" x 4.36"
(18.8 x 10.9 x 11 cm)

WEIGHT: 2.47 lbs (1123 g)

COLOR: Orange or Yellow

44301	Standard System with 120V AC/12V DC, with shoulder strap and charging rack – Yellow
44305	Vehicle Mount System with 12V DC, with shoulder strap and charging rack – Yellow
44307	Standard System with 120V AC/12V DC, with quick release strap and charging rack – Yellow
44311	Standard System with 120V AC/12V DC, with quick release strap and charging rack – Orange
44315	Vehicle Mount System with 12V DC, with quick release strap and charging rack – Orange



180° articulating head puts the light where you need it.

1,200 LUMENS

	HIGH	LOW
LUMENS:	1,200	350
CANDELA:	75,000	22,000
DISTANCE:	548m	296m
RUN TIME:	5h 45m	16h

Flat base area allows light to stand on its own for scene lighting.



Class I, Division 2, Groups A, B, C, D;
Class II, Division 2, Groups F, G;
Class III; T-Class: T4

NFPA

Meets requirements of
NFPA 1901-14.1.10.2 (2016);

Large, multi-function, push button switch easy to use with gloved hands.



Quick install charge rack fits same foot print as LiteBox® and Vulcan® Series.





E-FLOOD® LITEBOX®
E-FLOOD® FIREBOX®

Six LEDs spread light over an entire area. It has an extended run time - 18 hrs. on low - so you can keep large areas illuminated no matter how long your shift lasts. With its swivel head, you can point light right where it's needed. The FireBox has 2 rear blue LEDs so you can be seen from behind: a life-saving feature for firefighters!

E-FLOOD LITEBOX / E-FLOOD FIREBOX

BATTERY: Zero-maintenance, sealed lead acid

SIZE: 11.5" x 5.1" x 7"
(29.2 x 13 x 17.8 cm)

WEIGHT: 7.9 lbs (3.58 kg)

COLOR: Orange, Yellow or Beige (Power Failure model only)

E-FLOOD LITEBOX

- 45801 120V AC/12V DC, shoulder strap and mounting rack—Orange
- 45821 120V AC/12V DC, shoulder strap and mounting rack—Yellow
- 45805 Vehicle Mount System with 12V DC, shoulder strap—Orange
- 45825 Vehicle Mount System with 12V DC, shoulder strap—Yellow
- 45807 Power Failure w/120V AC/12V DC, mounting rack—Orange
- 45817 Power Failure w/120V AC/12V DC, mounting rack—Beige
- 45806 without Charger - with shoulder strap—Orange
- 45816 without Charger - Power Failure with shoulder strap—Beige
- 45826 without Charger - with shoulder strap—Yellow

E-FLOOD FIREBOX

- 45811 120V AC/12V DC, dual rear LEDs, strap, mounting rack—Orange
- 45815 Vehicle Mount System w/DC, dual rear LEDs, shoulder strap—Orange
- 45832 without Charger incl. shoulder strap—dual rear LEDs—Orange



	HIGH	LOW
LUMENS:	615	330
CANDELA:	4,000	2,150
DISTANCE:	126m	93m
RUN TIME:	8h	18h

NFPA

Rack meets requirements of NFPA 1901-14.1.10.2 (2016) mounted in any position



E-Flood FireBox includes dual safety blue rear LEDs.



The Power Failure System features "Smart" power failure circuitry which automatically illuminates the light when the power goes off

THE E-FLOOD & E-SPOT SERIES ARE ABOUT
DELIVERING
THE RIGHT LIGHT
EXACTLY WHERE
YOU NEED IT.

E-SPOT® LITEBOX®
E-SPOT® FIREBOX®

Three LEDs spotlight an area with focused bright light so you can search or inspect from a distance. Its beam has more of a hotspot than the E-Flood, providing more concentrated, brighter light. Its swivel head makes it easy to inspect high bays, ceilings, and out-of-the-way places. IPX4 rated for water-resistance. Optimized electronics provide regulated intensity. Unbreakable, scratch-resistant lens.

E-SPOT LITEBOX / E-SPOT FIREBOX

BATTERY: Zero-maintenance, sealed lead acid

SIZE: 11.5" x 5.1" x 7"
 (29.2 x 13 x 17.8 cm)

WEIGHT: 7.9 lbs (3.58 kg)

COLOR: Orange, Yellow or Beige (Power Failure model only)

E-SPOT LITEBOX

- 45851 120V AC/12V DC, shoulder strap and mounting rack – Orange
- 45871 120V AC/12V DC, shoulder strap and mounting rack – Yellow
- 45855 Vehicle Mount System with 12V DC, shoulder strap – Orange
- 45875 Vehicle Mount System with 12V DC, shoulder strap – Yellow
- 45857 Power Failure System, shoulder strap and mounting rack – Orange
- 45867 Power Failure System, shoulder strap and mounting rack – Beige
- 45856 without Charger - with shoulder strap – Orange
- 45866 without Charger - Power Failure with shoulder strap – Beige
- 45876 without Charger - with shoulder strap – Yellow

E-SPOT FIREBOX

- 45861 120V AC/12V DC, dual rear LEDs, strap, mounting rack – Orange
- 45865 Vehicle Mount System w/DC, dual rear LEDs, shoulder strap – Orange
- 45882 without Charger incl. shoulder strap – dual rear LEDs – Orange

	HIGH	LOW
LUMENS:	540	330
CANDELA:	55,000	32,000
DISTANCE:	469m	358m
RUN TIME:	7h	15h

NFPA

Rack meets requirements of NFPA 1901-14.1.10.2 (2016) mounted in any position



Power Failure System
 Power failure circuitry automatically illuminates the light when the power goes off.



E-Spot FireBox includes dual safety blue rear LEDs.

THE E-FLOOD HL
DELIVERS **FULL**
ILLUMINATION
FLOOD OR SPOT.

E-FLOOD® LITEBOX® HL

The intense brightness of its 5,300 lumens stretches from side to side and floods an entire area with light. Easy-to-use, twist to change diffuser lets you select from a flood and spot lens in all three lighting modes. 90° swivel neck lets you aim light where it's needed. Ideal for illuminating a rescue scene, an entire plant floor or any site that requires a large flood beam. The portability and full illumination is perfect for underground construction.

E-FLOOD LITEBOX HL

BATTERY: Zero-maintenance, sealed lead acid. Can also be powered by 12V DC power cord.

SIZE: 12.3" x 5.1" x 7.7"
(31 x 13 x 19 cm)

WEIGHT: 10.4 lb (4.7 kg)

COLOR: Orange

E-FLOOD HL LITEBOX

45661 120V AC/12V DC, shoulder strap & mounting rack - Orange

45665 Vehicle Mount System, 12V DC direct wire rack, shoulder strap - Orange

45660 without Charger - includes shoulder strap - Orange

Special Features:

- Six super-bright white LEDs
- Unbreakable, scratch-resistant, O-ring sealed lens.
- Provides regulated light output throughout battery life.

	HIGH	MEDIUM	LOW
LUMENS:	5,300	2,500	1,300
CANDELA:	42,000	21,300	11,600
DISTANCE:	410m	292m	215m
RUN TIME:	1h 45m	4h 30m	10h

5,300 LUMENS HL SERIES



NFPA

Rack meets requirements of NFPA 1901-14.1.10.2 (2016) mounted in any position

**LANTERN SERIES
ACCESSORIES**

At Streamlight, we engineer the highest performing, most rugged, durable and innovative lights on the market. In addition, we support them with the accessories you can depend on and the options and configurations that you need to accommodate all your portable lighting needs.

	Lantern Accessories	PORTABLE SCENE LIGHT	HID LITEBOX	E-FLOOD LITEBOX HL	E-FLOOD LITEBOX / FIREBOX	E-SPOT LITEBOX / FIREBOX	FIRE VULCAN LED	VULCAN 180
	Standard Charge Rack	—	—	—	—	—	44103-Black	44350-Black
	Direct Wire 12V DC Charge Rack	—	—	—	—	—	44132-Black	—
	Standard Mounting Rack	—	45070-Orange 45075-Black	45070-Orange 45072-Yellow 45073-Beige	45070-Orange 45072-Yellow 45073-Beige	45070-Orange 45072-Yellow 45073-Beige	45070-Orange	—
	Vehicle Mounting Rack	—	45071-Orange 45074-Yellow	45071-Orange 45074-Yellow	45071-Orange 45074-Yellow	45071-Orange 45074-Yellow	45071-Orange	—
	12V CIG Charge Cord	—	22051	22051	22051	22051	22051	22051
	12V DC Charge Cord	—	22050	22050	22050	22050	22050	22050
	12V DC Charge Cord (10ft / 3m)	22056	22056	—	—	—	—	—
	120 AC Charge Cord	—	22060	22060	22060	22060	22060	22060
	E-Spot Upgrade for LiteBox/FireBox	—	—	—	—	45845	—	—
	E-Flood Upgrade for LiteBox/FireBox	—	—	—	45842	—	—	—
	HID LiteBox Lens/Filters	—	45637-HID Bulb Kit 45638-Lens Refl. 45657-Flood Lens 45654-IR Filter	—	—	—	—	—
	Quick Release Shoulder Strap	44050	44050	44050	44050	44050	44050	44050
	Shoulder Strap	45232	45232	45232	45232	45232	45232	45232
	Replacement Battery	45630	45630	45630	45937	45937	44610	44351

STREAMLIGHT
WAYPOINT SERIES

WAYPOINT®

This long-distance, pistol-grip lantern is the light you need to inspect a power line from the ground, find a dock from the interior of a lake or to see whatever is way up ahead. Its beam reaches about the length of 6 football fields! It also has plenty of peripheral light, so you can see what's all around you. Set it down to illuminate an entire area or aim it to check on trees or power lines far away. Features 3 modes including a strobe for signaling.

WAYPOINT

BATTERY: 4 "C" batteries (not included). Can also be powered by 12V DC power cord (included)
SIZE: 6.75" x 7.14" x 3.5" (17.15 x 18.14 x 8.89 cm)
WEIGHT: 1.8 lb (816 g)
COLOR: Yellow or Black

YELLOW BLACK

44900	44902	12V DC power cord*— w/polymer storage mount
44904	44905	12V DC power cord*

ACCESSORIES

44908	44908	Polymer Storage Mount
44903	44903	12V DC power cord*
44924	44924	Red Filter
44925	44925	Green Filter

*12V DC power cord does not recharge batteries



Trigger style switch with momentary operation.



	HIGH	LOW
LUMENS:	550	40
CANDELA:	100,000	7,900
DISTANCE:	625m	178m
RUN TIME:	10h	82h

Unlimited run time when using 12V DC power cord. Emergency signal run time 82 hours.



Green Filter reduces shadows.

Red Filter preserves night vision.

WAYPOINT® RECHARGEABLE

The rechargeable model has a broader, wider beam than the alkaline Waypoint. It spreads bright light across a whole room, campsite or backyard illuminating everything, yet its beam still reaches an impressive 678 meters. IPX8 rated design waterproof to 2 meters. Light floats if dropped in water. Includes 3 modes: low, medium and high. With its integrated stand you can set it up for easy area illumination. Fully recharges in 4 hours.

WAYPOINT RECHARGEABLE

BATTERY: Lithium Ion with on-board safety control circuit
SIZE: 6.75" x 7.14" x 3.62" (17.15 x 18.14 x 9.29 cm)
WEIGHT: 1.52 lb (691 g)
COLOR: Yellow or Black

YELLOW BLACK

44910	44911	with 120V AC charge cord
-------	-------	--------------------------

ACCESSORIES

44918	44918	Polymer Storage Mount
44915	44915	Red Filter
44916	44916	Green Filter
44923	44923	12V DC charge cord
44909	44909	120V AC charge cord

Green Filter reduces shadows.



Red Filter preserves night vision.



The Waypoint rechargeable holder allows for secure storage (included with product and also offered as an accessory).



Includes 120V Charge Cord.

	HIGH	MEDIUM	LOW
LUMENS:	1,000	550	35
CANDELA:	115,000	60,000	10,000
DISTANCE:	678m	490m	200m
RUN TIME:	3h 45m	7h 30m	87h

THE WAYPOINT FAMILY NOW ADDS DUALIE FUNCTIONALITY.



DUALIE WAYPOINT®

The Dualie Waypoint® light offers dual light technology with a forward facing spot beam and a bottom facing flood light that can be used individually or at the same time. See what's ahead of you and right in front of your feet with the Dualie Waypoint. Its bright light, which shines both ahead of you and downward, helps you avoid slips, trips and falls. Multiple hands-free uses - hang it over a door, stand it on its kickstand or hang it with integrated D-ring. The ergonomic handle hooks over any door, pipe, bar, cable or ladder rung for hands free operation. It also includes an integrated stand to make the light perfect for any lighting need. The light is sealed and floats, so it's great for wet applications.

DUALIE WAYPOINT

BATTERY: (4) "C" alkaline batteries

SIZE: 6.75" x 6.5" x 3.55"
(17.14 x 16.5 x 9.0 cm)

WEIGHT: 2.06 lbs (934 g) w/o batteries

COLOR: Yellow/Black



44940 Yellow/Black

44955 Yellow/Black – box

SPOT BEAM	HIGH	MEDIUM	LOW
LUMENS:	750	500	35
CANDELA:	75,000	45,000	3,200
DISTANCE:	548m	426m	113m
RUN TIME:	3h 30m	6h	125h

FLOOD BEAM	HIGH	MEDIUM	LOW
LUMENS:	500	230	25
CANDELA:	250	120	10
DISTANCE:	31m	22m	6m
RUN TIME:	5h	12h 30m	170h

BOTH LIGHTS	HIGH	MEDIUM	LOW
LUMENS:	1,000	600	75
RUN TIME:	3h	6h	55h



Push button switch with momentary and click on operation. The rotary switch selects the main/front beam, bottom/area light, or both.



LED bottom facing flood light can be used individually or with the forward facing spot beam.



Integrated stand and D-ring for hands-free lighting.

SUPER SIEGE THE HARDEST
WORKING
SIEGE LANTERN.

SUPER SIEGE® RECHARGEABLE LANTERN

The Super Siege® Lantern features five LEDs, one white and four red with six output modes and a battery level indicator built into the on/off button. A rechargeable lithium ion battery supplies the power for the lantern as well as enabling you to recharge all your electronic devices from the handy USB port. With the outer lantern globe in place, the light will float. Use the lantern with or without the outer globe cover. Remove the outer globe and hang the body upside down by the D-ring for large area lighting needs. Utilize the included “Glare Guard” to shield light from 1/2 the globe, allowing you to direct light on your work zone. A small storage area is provided in the base of the light for all your “keep dry” needs. Simply rotate the bottom cover counter clock wise to remove and access the storage compartment.

SUPER SIEGE

BATTERY: Lithium Ion Rechargeable

SIZE: 3.8" x 7.5" (9.65 x 19.05 cm)

WEIGHT: 1 lb 14 oz (867.62 g)

COLOR: Coyote or Yellow

44947 Super Siege Lantern w/ AC power cord – Coyote

44945 Super Siege Lantern w/ AC power cord – Yellow

SUPER SIEGE ACCESSORY

44951 Magnetic Base – Black

44950 Glare Guard

[1] WHITE LED	HIGH	MEDIUM	LOW
LUMENS:	1,100	550	125
RUN TIME:	5h 45m	11h 30m	36h 15m

Light output with outer globe removed.

[4] RED LEDs	HIGH	FLASH/SOS MODE	LOW
LUMENS:	2.7	2.7	1
RUN TIME:	140h	320h	348h

With **[(RED SOS)]**

Hold on/off button to activate.

1,100 LUMENS



A small dry storage area is provided in the light's base for all your “keep dry” needs

Rechargeable lithium ion battery supplies the power for the lantern as well as enabling you to recharge all your electronic devices from the handy USB port.



Magnetic Accessory Base



THE SIEGE SERIES. THEY'VE GOT SURVIVAL INSTINCTS.

THE SIEGE® LANTERN

The Siege is brighter, more durable, and much more versatile than other emergency/camping lanterns. It's bright enough to light up a whole campsite. It runs for over 30 hours on high, and over 12 days on low! Its handle and D-ring allow you to hang it or clip it almost anywhere, upright or inverted. It has 3 white light settings, a red light for softer, less intense light, and an SOS mode. Remove the top for brighter light. Battery indicator flashes to alert you to low battery.

THE SIEGE

BATTERY: (3) "D" size alkaline
SIZE: 3.8" x 7.25" (9.65 x 18.41 cm)
WEIGHT: 1 lb 15 oz (878 g)
COLOR: Coyote

44931 The Siege Lantern – Coyote

SIEGE ACCESSORY

44952 Magnetic Base – Black
 44950 Glare Guard

Magnetic
Accessory Base



Shown with
outer globe
removed.

(4) WHITE LEDs	HIGH	MEDIUM	LOW
LUMENS:	540	275	55
RUN TIME:	30h	70h	295h

Light output with outer globe removed.

(1) RED LED	HIGH	FLASH/SOS MODE
LUMENS:	10	10
RUN TIME:	235h	430h

Special Features:

- Floats for easy retrieval.
- Waterproof to 1 meter.
- 2 meter impact-resistance tested.
- Unbreakable lens.
- Rugged, non-slip base.

With **[(RED SOS)]**
Hold on/off button to activate.

Versatile design features rugged carry handle and D-rings clip to hang virtually anywhere.



SIEGE® AA LANTERN

The Siege® AA lantern features one white LED, and two red LEDs (or two blue LEDs on the blue C.O.P.S. model). There are five output modes and a battery level indicator built into the on/off button. With the outer lantern globe in place, the light will float. Use the lantern with or without the outer globe cover. Remove the outer globe and hang the body upside down by the D-ring for large area lighting needs. Battery replacement is a breeze with the center post orienting the battery cover correctly every time.

SIEGE AA

BATTERY: (3) "AA" size alkaline
SIZE: 2.37" x 5.44" (6.00 x 13.82 cm)
WEIGHT: 8.8 oz (249.47 g)
MAG. MODEL WEIGHT: 9.1 oz (257.98 g)
COLOR: Coyote, Yellow, Red, Pink or Blue

44941 Siege AA Lantern – Coyote
 44943 Siege AA Lantern – Yellow w/magnetic base
 44953 Siege AA Lantern – Red
 44944 Siege AA Lantern – Pink
 44949 Siege AA Lantern – Blue

SIEGE AA ACCESSORY

44942 Magnetic Base – Coyote

WHITE LED	HIGH	MEDIUM	LOW
LUMENS:	200	100	50
RUN TIME:	7h	15h 30m	37h

Light output with outer globe removed.

(2) RED LEDs	HIGH	FLASH/SOS MODE
LUMENS:	.7	.7
RUN TIME:	192h	288h

With **[(RED SOS)]**
Hold on/off button to activate.



The yellow Siege AA has three strong magnets in the base. It's now a versatile, hands-free work light that can be attached to steel surfaces like engines, machines, or other equipment.





RIGHT-ANGLE
SERIES //

RIGHT-ANGLE LIGHTING

WHETHER IT'S ON THE BODY OR ON THE HELMET, STREAMLIGHT DELIVERS THE TRUSTED OPTIONS.

Ask any firefighter what light they trust most... and the likely answer is the Streamlight Survivor. And while we're proud of that fact, we're also not one to let it rest at that. We continue to develop products that keep firefighters and industrial workers safe. Because as we all know, the work is never truly done.



VANTAGE® II

SURVIVOR®

VANTAGE®
180 X USB

STREAMLIGHT
RIGHT ANGLE SERIES



The low profile Survivor shown at actual size.

SURVIVOR ACCESSORIES



Battery Chargers

Fits All

Battery Packs

Fits All

Charge Cords

PN

Smart Charger Holder	90116	Alkaline Battery Cartridge	90542	120V AC	22060
AC Fast Charger (Includes Holder)	90011	Battery Pack Assembly – LED Div. 1	90130	12V DC Cigarette Lighter	22051
DC#1 Cigarette Lighter Cord/Fast Charger (Includes Holder)	90012	Battery Pack Assembly – LED Div. 2	90338	12V DC Direct Wire	22050
DC#2 Direct Wire Cord/Fast Charger (Includes Holder)	90013				
120V AC Bank Charger	90400			Addtl Accessories	PN
12V DC Bank Charger	90401			Smoke Cutter Plug Kit	908019

THE MOST TRUSTED RIGHT ANGLE LIGHT. THIN, BRIGHT & VERSATILE. THE LEGENDARY SURVIVOR.

SURVIVOR®

The leading Class I, Div. 1 right angle, clip-on flashlight features a slim profile and a dependable clip/hook for more accurate light orientation. 4 lighting modes include high, low, flash, and a moonlight mode for low-level lighting that runs for 20 days. Spring-loaded clip easily attaches to belts and harnesses. Comes with two special, interchangeable Smoke Cutter® plugs that help create your preferred beam pattern: Black plug significantly reduces peripheral light for a tighter beam while the Amber plug reduces peripheral light and eye fatigue caused by glare. Available in alkaline and rechargeable models.

All openings are O-ring sealed for weather-resistance. IPX4 rated water-resistant. 2 meter impact resistance tested. Unbreakable, scratch-resistant polycarbonate lens. Designed for easy operation even with heavy gloves.

SURVIVOR

BATTERY: NiCd Rechargeable or (4) "AA" Alkaline depending on model selected

SIZE: 7.6" x 2.85" x 2.87"
(17.92 x 7.24 x 7.29 cm)

NiCd WEIGHT: 18 OZ (510 g)

ALKALINE WEIGHT: 13.7 OZ (388 g)

COLOR: Orange, Yellow, or Black

YELLOW ORANGE BLACK

YELLOW	ORANGE	BLACK	
90513	90503	90523	w/Charger/ Holders 120V AC/DC cords
90512	90502	90522	with 120V AC Fast Charger
90519	90509	90528	with 12V DC Fast Charger
90510	90500	90520	without Charger
90541	90540	90545	Alkaline



Alkaline battery cartridge holds four "AA" alkaline batteries.



NiCd MODEL	HIGH	LOW
LUMENS:	175	60
CANDELA:	41,000	14,000
DISTANCE:	405m	237m
RUN TIME:	3h 30m	13h

Moonlight mode: 20 days of continuous run time
Flash runs 8 hours

ALKALINE MODEL	HIGH	LOW
LUMENS:	175	60
CANDELA:	41,000	14,000
DISTANCE:	405m	237m
RUN TIME:	4h	15h

Moonlight mode: 20 days of continuous run time
Flash runs 8 hours

NFPA Rack meets requirements of 1901-14.1.10.2 (2016) mounted in any position



Class I & II, Division 1, Groups C, D, E, F, G;
Class III, T4, Class 1 Zone D IIB
Class I, Division 2, Groups A, B, C, D; T4
Class 1 Zone 2 IIC

Clip/hook designed for accurate light orientation

Interchangeable Smoke Cutter® plugs:



Black reduces peripheral light for a tighter beam

Amber reduces peripheral light and eye fatigue caused by glare





VANTAGE® II

Lightweight, compact and low profile, the VANTAGE® II is designed to easily attach above or below full brim Fire Helmets or Slotted Industrial Hard Hat mounts. The light features the latest in power LED technology combined with an ultra-bright blue LED safety taillight. Powered by a single lithium battery, sealed for water-resistance.

VANTAGE II

BATTERY: (1) 3V CR123A lithium

SIZE WITH FIRE MOUNT: 2.37" x 1.16" x 2.18"
(6.01 x 2.95 x 5.54 cm)

SIZE WITH INDUSTRIAL MOUNT: 2.37" x 1.16" x 1.54"
(6.01 x 2.95 x 3.91 cm)

FIRE MOUNT WEIGHT: 3.65 oz (103.5 g)

INDUSTRIAL MOUNT WEIGHT: 2.97 oz (84.2 g)

COLOR: Black

69331	Fire Helmet Mount & CR123A lithium battery - Box
69333	Industrial Hard Hat Mount & CR123A lithium battery - Box

ACCESSORIES

69334	Bracket Kit - Vantage II - Fire
69336	Bracket Kit - Vantage II - Industrial
85175	Lithium Batteries—2 Pack
85180	Lithium Batteries—6 Pack
85177	Lithium Batteries—12 Pack
85179	Lithium Batteries—400 Pack

NFPA Meets requirements of NFPA 1971-8.6 (2013); 500° heat resistance test

CE Meets applicable European Community Directives



NEW

Fire model

Large push-button switch features blue taillight LED that ensures you can be seen even from behind.



	HIGH	LOW
LUMENS:	350	135
CANDELA:	3,500	1,700
DISTANCE:	118m	80m
RUN TIME:	2h 15m	5h



Attaches securely to your helmet - above or below brim in seconds!



Industrial model features hard hat mount that slides into V-Guard slot.



Industrial model

VANTAGE® 180 X USB VANTAGE® 180 X

This multi-fuel, multi-function light is the most versatile rechargeable firefighter's light. It's a helmet mounted light, right angle light and a hand-held flashlight. The Vantage 180 X USB is a rechargeable system that comes with our new 18650 USB battery with integrated USB charging port. The Vantage 180 X comes with two CR123 batteries. Easily attaches above or below the brim of most helmets providing a bright main white LED and blue safety taillight. Quickly detaches for hand-held and clip-on right angle light with white taillight and downcast light to see what's at your feet. IPX7 waterproof.

Head articulates 180° to aim the beam.

WITH 18650	HIGH	LOW
LUMENS:	250	100
CANDELA:	7,200	2,650
DISTANCE:	170m	103m
RUN TIME:	5h	15h

WITH CR123	HIGH	LOW
LUMENS:	250	100
CANDELA:	7,200	2,650
DISTANCE:	170m	103m
RUN TIME:	4h	12h



Use as a helmet light. Easily attaches above or below brim. No tools necessary to quickly remove for use as a hand-held flashlight

VANTAGE 180 X USB

BATTERY: (1) 18650 USB
SIZE: 5.20" x 1.60" x 1.06"
(13.20 x 4.06 x 2.69 cm)
WEIGHT: 5.9 OZ (167 g)
COLOR: Black or Orange

VANTAGE 180 X

BATTERY: (2) 3V CR123A lithium
SIZE: 5.20" x 1.60" x 1.06"
(13.20 x 4.06 x 2.69 cm)
WEIGHT: 5.5 OZ (156 g)
COLOR: Black or Orange

88911	Vantage 180 X USB, 18650 Battery, Helmet Bracket—Box — Orange
88913	Vantage 180 X USB, 18650 Battery, Helmet Bracket—Box — Black
88901	Vantage 180 X, two CR123A Lithium Batteries, Helmet Bracket—Box — Orange
88903	Vantage 180 X, two CR123A Lithium Batteries, Helmet Bracket—Box — Black



X USB MULTI-FUEL FLEXIBILITY

ALLOWS YOU TO POWER YOUR LIGHT WITH (1) STREAMLIGHT RECHARGEABLE 18650 USB LITHIUM BATTERY OR (2) CR123A LITHIUM BATTERIES

Includes "quick release" helmet bracket and hex key.



Rear LED Taillight changes from blue to white:

- Blue LED for helmet mount use and visibility in heavy smoke
- White LED for a downcast flood light to see what's at your feet; switches from blue when head is at a 90° angle



ACCESSORIES

22010	18650 Charger Kit-USB (incl. (2) 18650 USB batteries)
22011	18650 Charger Kit-120V AC (incl. (2) 18650 USB batteries)
22100	18650 Battery Charge Cradle
22070	USB Cord A to MICRO 40" (101cm)
22081	USB Cord A to USB MICRO 22" (55.88 cm)
22082	USB Cord Y-Split
22101	18650 USB Battery
22102	18650 USB Battery - 2 Pack
85175	Lithium Batteries—2 Pack
85180	Lithium Batteries—6 Pack
85177	Lithium Batteries—12 Pack
85179	Lithium Batteries—400 Pack

NFPA Meets requirements of NFPA 1971-8.6 (2013); 500° heat resistance test

CE Meets applicable European Community Directives



VANTAGE®

The solution to firefighters' hands-free lighting needs. Attaches easily to helmets and hard hats, and rotates 360°. Fits snugly against helmet to prevent snags. Includes a bright tail light so you can be seen from behind even in heavy smoke (blue on black & red models, green on green model). Easy to operate with gloves. Fits both traditional and modern helmets.

VANTAGE

BATTERY: (2) 3V CR123A lithium

SIZE: 3.26" x 1.47" x 2.56"
(8.28 x 3.73 x 6.5 cm)

WEIGHT: 5.14 oz (145.7 g)

COLOR: Black, Green or Red

69140	Vantage LED Tactical Helmet Light—Black
69189	Vantage LED Tactical Helmet Light—Green
69157	Vantage LED Tactical Helmet Light—Red

ACCESSORIES

85175	Lithium Batteries—2 Pack
85180	Lithium Batteries—6 Pack
85177	Lithium Batteries—12 Pack
85179	Lithium Batteries—400 Pack

LUMENS:	115
CANDELA:	7,000
DISTANCE:	167m
RUN TIME:	6h



Dual direction, easy access on/off switch.

470nm ultra-bright taillight LED.

NFPA Meets requirements of NFPA 1971-8.6 (2013); 500° heat resistance test

CE Meets applicable European Community Directives



Congress created the National Fallen Firefighters Foundation to lead a nationwide effort to honor America's fallen firefighters. Since 1992, the non-profit foundation has developed and expanded programs that fulfill that mandate. Their mission is to honor and remember America's fallen fire heroes and to provide resources to assist their survivors in rebuilding their lives. For more information, visit www.firehero.org.

See page 146 to learn how buying a light for a cause benefits these organizations.



WHEN IT COMES TO RIGHT ANGLE & HELMET LIGHTING
THERE'S ALWAYS MORE THAN ONE RIGHT ANSWER.

POLYTAC 90®

Versatile, right angle compact flashlight can clip on to turn-out gear or be used as a headlamp. It's super bright, extremely durable in a nylon polymer housing and can be operated easily with gloves. 3 modes include a strobe function. 90° head. 1 meter impact resistance tested. IPX7 rated design; waterproof to 1 meter for 30 minutes. Integrated carabiner style D-ring for a variety of attachment methods. Integrated clip allows a variety of mounting positions. Maximum light output throughout battery life.

POLYTAC 90

BATTERY: (2) 3V CR123A Lithium batteries

SIZE: 5.22" x 1.25" x 1" (13.3 x 3.18 x 2.54 cm)

WEIGHT: 4.1 oz (116 g)

COLOR: Black, Yellow or Orange

YELLOW ORANGE BLACK

88831	88834	88830	with lithium batteries
-	88832	-	with lithium batteries & Gear Keeper

ACCESSORIES

88833	88833	88833	Gear Keeper®
14059	14059	14059	Elastic Headstrap - Coyote

NFPA Meets requirements of NFPA 1971-8.6 (2007)



Headstrap

	HIGH	LOW
LUMENS:	170	17
CANDELA:	7,000	700
DISTANCE:	167m	53m
RUN TIME:	3h 45m	30h

Strobe runs 6 hours



Gear Keeper® makes your job easier while preventing loss of light.



Gear Keeper® Tether features spectra nylon line with 36" extension and 6 oz. retraction force.



WHETHER YOU'RE WORKING ON THE FLOOR
OR OVERHEAD, THE
KNUCKLEHEAD
IS YOUR PARTNER.

STREAMLIGHT TASK-SPECIFIC TECHNOLOGY:
CHOOSE THE LIGHT INTENSITY ALLOWING YOU TO
CHOOSE THE RIGHT LIGHT FOR THE JOB.



AIM IT ANYWHERE //
WITH AN ARTICULATING HEAD.

ATTACH IT TO STEEL //
WITH ITS MAGNET.



CLIP IT ANYWHERE //
WITH A SPRING-LOADED CLIP.
(ORANGE MODEL.)



HANG IT ANYWHERE //
WITH AN INTEGRATED
STOWABLE HOOK. (YELLOW & BLACK MODELS.)



KNUCKLEHEAD® FLOOD

A lightweight, rechargeable, hand-held work light that hangs or attaches a variety of ways to flood your entire work area with light. Even light pattern is easy on your eyes. Articulating head rotates 360°, making it easy to aim light where it's needed. Removable magnet. Unbreakable, anti-scratch, O-ring sealed lens. IPX4 rated for water-resistance. All openings are O-ring sealed. 2 meter impact-resistance tested. Orange model comes with clip; integrated hook on yellow and black models.

KNUCKLEHEAD FLOOD

BATTERY: Rechargeable NiMh; optional 4 "AA" alkaline non-rechargeable battery cartridge.

SIZE: 9.2" x 2.85" x 2.75"
(23.4 x 7.2 x 7 cm)

NiMH WEIGHT: 1 lb 7.1 oz (655 g)

ALKALINE WEIGHT: 1 lb 2.3 oz (519 g)

COLOR: Orange, Yellow, or Black

YELLOW ORANGE BLACK

90627	90657	90607	Charger/Holder and 120V AC & 12V DC cords
90622	—	90602	120V AC Charger/Holder
90626	—	90606	12V DC
90631	90661	90611	120V AC Fast Charger
90640	90670	90620	12V DC Fast Charger
90621	90651	90601	without Charger
90642	90644	90641	Alkaline Model

Orange model comes with Clip, Black & Yellow models come with Hook

	HIGH	LOW
LUMENS:	200	63
CANDELA:	1,150	350
DISTANCE:	68m	37m
RUN TIME:	3h 30m	16h

Moonlight mode: 20 days of continuous run time
Flash: 8 hours continuous time



Class I, Div. 2, Grps A, B, C, D,
Class II, Div. 2, Grps F, G
Class III T4

NFPA

Rack meets requirements of 1901-14.1.10.2 (2016) mounted in any position



	HIGH	LOW
LUMENS:	180	55
CANDELA:	11,000	3,300
DISTANCE:	210m	115m
RUN TIME:	3h 30m	16h

Moonlight mode: 20 days of continuous run time
Flash: 8 hours continuous time

Spring-loaded clip attaches to turn-out gear for convenient hands-free lighting.



Class I, Div. 2, Grps A, B, C, D,
Class II, Div. 2, Grps F, G
Class III T3C

NFPA

Rack meets requirements of 1901-14.1.10.2 (2016) mounted in any position



Powerful magnet adheres to steel surfaces.

KNUCKLEHEAD® SPOT

Its far-reaching beam helps locate hazards or victims from a distance. Articulating head makes it easy to aim light where it's needed. Powerful, removable magnet. Smoke-cutting beam. Spring-loaded clip for easy attachment to turnout gear and uneven surfaces. 4 modes include high, low, flash and a moonlight mode for 20-day runtime. Features are designed to give firefighters added flexibility. Unbreakable, anti-scratch, O-ring sealed lens. IPX4 rated for water-resistance. 2 meter impact-resistance tested. All openings are O-ring sealed.

KNUCKLEHEAD SPOT

BATTERY: Rechargeable NiMh; optional 4 "AA" alkaline non-rechargeable battery cartridge.

SIZE: 9.2" x 2.85" x 2.75"
(23.4 x 7.2 x 7 cm)

NiMH WEIGHT: 1 lb 7.1 oz (655 g)

ALKALINE WEIGHT: 1 lb 2.3 oz (519 g)

COLOR: Orange

90757	120V AC/12V DC - Orange
90761	120V AC Fast Charge - Orange
90770	12V DC Fast Charge - Orange
90751	Light Only (without charger) Orange
90744	Alkaline Model - Orange

KNUCKLEHEAD ACCESSORIES

Battery Chargers

	Fits All	Battery Packs	Fits All	Charge Cords	PN
Smart Charger Holder	90116	Alkaline Battery Cartridge	90542	120V AC	22060
AC Fast Charger (Includes Holder)	90011	Battery Pack Assembly—LED Div. 1	90335	12V DC Cigarette Lighter	22051
DC#1 Cigarette Lighter Cord/Fast Charger (Includes Holder)	90012	Battery Pack Assembly—LED Div. 2	90338	12V DC Direct Wire	22050
DC#2 Direct Wire Cord/Fast Charger (Includes Holder)	90013				
120V AC Bank Charger	90400				
12V DC Bank Charger	90401				

SAFETY-RATED SERIES //



SAFETY-RATED LIGHTING

BECAUSE YOU DON'T GET TO CHOOSE WHERE IT'S GOING TO BE DARK.

Streamlight builds more safety-rated lights to give you more options in hazardous locations. With our comprehensive product line of Dualies, ProPolymers, Knuckleheads and headlamps – you have a full selection of safety-rated lights no matter your lighting need... right-angle, wearable or with laser pointing options.



KNUCKLEHEAD®
HAZ-LO®
SPOT

3AA PROPOLYMER®
HAZ-LO®

DUALIE®
RECHARGEABLE
MAGNET



STREAMLIGHT SAFETY-RATED SERIES.

// DIFFERENT LIGHTS FOR DIFFERENT HAZARDOUS LOCATIONS.

The National Electric Code (NEC) defines hazardous locations by “class” and “division.” There are three classes:



CLASS I locations are made hazardous by the presence of flammable gases, liquids or vapors.



CLASS II locations are hazardous because combustible dusts are present.



CLASS III locations contain easily ignitable fibers or flyings.

The “Division” designation refers to the likelihood that ignitable concentrations of flammable materials are present. There are two divisions:

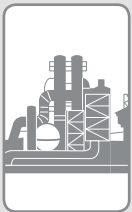

DIVISION 1 designates an environment where ignitable concentrations of flammable gases, liquids, vapors or dusts can exist some of the time or all of the time under normal operating conditions, or where easily ignitable fibers and flyings are manufactured, handled or used.



DIVISION 2 locations are where ignitable concentrations are not likely to exist under normal operating conditions or where Class 3 materials are stored or handled.

Hazardous classes are further defined by “groups” based on the physical properties of their combustible materials. These groups include (but are not limited to):



GROUP A Acetylene
GROUP B Hydrogen
GROUP C Ethylene, carbon monoxide
GROUP D Propane, gasoline, naphtha, benzene, butane, ethyl alcohol, acetone, methane



GROUP E Metals including aluminum, magnesium (Div. 1 only)
GROUP F Carbonaceous dusts including coal, carbon black, coke
GROUP G Dusts not included in E and F including wood, plastics, flour, starch or grain dusts



STREAMLIGHT GIVES YOU MORE SAFETY-RATED LIGHTS FOR MORE OPTIONS IN HAZARDOUS LOCATIONS.

Streamlight flashlights are tested and certified by the world's leading independent laboratories – including Underwriters Laboratories, ATEX, Demko, and the Mine Safety and Health Administration (MSHA). This testing is your assurance that the Streamlight flashlight you choose will be safe in the environment(s) in which you'll be using it.



// STREAMLIGHT'S HAZ-LO LIGHTS - 2 STANDARDS PROVIDE DIFFERENT PATHS TO THE SAME RESULT: A DIVISION 1 RATING!

When working in a Division 1 area, we expect explosive atmospheres to be present. Streamlight's HAZ-LO product line is suitable for use in Division 1 areas. Streamlight uses different protection standards and testing at Nationally Recognized Test Labs (NRTL) to achieve the Division 1 rating that is common to all Streamlight HAZ-LO Lighting. This is the best possible performance while ensuring that your flashlight will not become an ignition source. ANSI/UL 783 is the specific standard for flashlights used in hazardous locations. ANSI/UL 913 is the intrinsically safe standard for general electronic equipment. While either standard can direct certification to Division 1 level, it is important to note Class, Group and Temperature code requirements to select the correct flashlight for specific applications.

// WHY ARE SAFETY RATINGS IMPORTANT?

There are several types of locations in which it can be extremely dangerous to use any light that has not been specifically designed – and approved – for that kind of location. These are areas where fire or explosion hazards may exist due to the presence of flammable gases, liquids, vapors, dusts, or ignitable fibers or flyings. If you will be using a flashlight in any potentially hazardous location, it is critical that your light be safety-rated for that specific kind of environment.

// ATEX RATINGS

Streamlight also offers safety-rated lights that comply with the European Union (EU) Directive 2014/34/EU (ATEX) for products intended for use in potentially explosive atmospheres within the EU member countries. Please visit our website, streamlight.com for more information on ATEX-rated products. We also have a catalog of ATEX-rated products available upon request.



THE DUALIE[®] FAMILY OF LIGHTS
DIV. 1, INTRINSICALLY SAFE,
DUAL BEAMS,
HANDS-FREE & INCREDIBLY VERSATILE.

DUAL BEAM DESIGN:



The Dualie design allows you to see what's ahead of you and right in front of your feet. Its bright light, which shines both ahead of you and downward, helps you avoid slips, trips and falls.

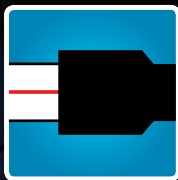

The Dualie Laser features a simultaneous spot beam and laser pointer allowing you to illuminate the work area and pinpoint out-of-reach objects.

THE LIGHTS THAT WORK. ARE NOW THE LIGHTS THAT CHARGE. INTRODUCING THE DUALIE RECHARGEABLES.

DUALIE® RECHARGEABLE

The Dualie® Rechargeable features a lithium ion battery and dual beams — forward facing LED spot beam and a side facing LED flood light that can be used individually or at the same time for enhanced safety. Integrated, non-protruding spring loaded belt clip contained within body outline.

	SPOT	FLOOD	COMBINED
LUMENS:	180	105	275
CANDELA:	11,500	60	—
DISTANCE:	171m	18m	—
RUN TIME:	7h 15m	13h 30m	5h 30m



Features a forward facing LED spot beam and a side facing LED flood light that can be used individually or at the same time for enhanced safety.

NEW



Class I & II, Div. I, Groups A,B,C,D,E,F,G
Class III, CL I, ZN O, IIC
T-Code: T4; Exia



DUALIE RECHARGEABLE

BATTERY: Lithium Ion Rechargeable

SIZE: 7" x 1.86" x 1.06" (17.78 x 4.72 x 2.69 cm)

WEIGHT: 6.8 OZ (193 g)

COLOR: Yellow or Black

YELLOW BLACK

68732	68733	White LED/120V/100V AC—Box
68734	68735	White LED/12V DC Direct Wire—Box
68730	68731	Light Only—Box

ACCESSORIES FOR ALL DUALIE RECHARGEABLE MODELS

68792	Lithium ion battery - Dualie Rechargeable
68790	Charger Holder
68789	Bank Charger
22080	12V DC Direct Wire USB Accessory
22069	12V DC USB Adapter
22070	40" USB Cord
22071	120V AC USB Cord
68089	Poly Mount Kit
99075	Rubber Helmet Strap
68085	Helmet Mount

DUALIE® RECHARGEABLE MAGNET

The Dualie® Rechargeable Magnet features all the great versatility and attributes of the standard Dualie Rechargeable and also incorporates two magnets into its integrated, non-protruding spring loaded belt clip for hands-free use.

	SPOT	FLOOD	COMBINED
LUMENS:	180	105	275
CANDELA:	11,500	60	—
DISTANCE:	171m	18m	—
RUN TIME:	7h 15m	13h 30m	5h 30m



Features a forward facing LED spot beam and a side facing LED flood light that can be used individually or at the same time for enhanced safety.

Integrated magnet for hands-free use

NEW



Class I & II, Div. I, Groups A,B,C,D,E,F,G
Class III, CL I, ZN O, IIC
T-Code: T4; Exia



DUALIE RECHARGEABLE MAGNET

BATTERY: Lithium Ion Rechargeable

SIZE: 7.50" x 1.86" x 1.06" (19.05 x 4.72 x 2.69 cm)

WEIGHT: 7.1 OZ (201 g)

COLOR: Yellow or Black

YELLOW BLACK

68793	68794	White LED/120V/100V AC—Box
68795	68796	White LED/12V DC Direct Wire—Box
68785	68796	Light Only—Box



DUALIE® 2AA

The Dualie® 2AA is an intrinsically safe, high performance, battery powered multi-function LED flashlight. The flashlight features a forward facing LED spot beam and a side facing LED flood light that can be used individually or at the same time for enhanced safety. The flashlight has opposing switches for easy user activation of desired function(s). Includes removable, reversible clip and integrated magnet.

	SPOT	FLOOD	COMBINED
LUMENS:	115	115	175
CANDELA:	3,100	75	—
DISTANCE:	111m	17m	—
RUN TIME:	24h	24h	15h



Integrated magnet for hands-free use



Features a forward facing LED spot beam and a side facing LED flood light that can be used individually or at the same time for enhanced safety.

SGS
Class I & II, Div. I, Groups A, B, C, D, E, F, G;
Class III, CL I, ZN O, IIC
T-Code: T4; Exia

DUALIE 2AA

BATTERY: 2 “AA” size alkaline
SIZE: 6.10" x 1.34" x .87" (15.5 x 3.4 x 2.2 cm)
WEIGHT: 3.9 oz (111 g)
COLOR: Yellow or Black

YELLOW BLACK

67750	67752	White LED/alkaline batteries – Clam
67751	67753	White LED/alkaline batteries – Box

ACCESSORIES

68089	Poly Mount Kit
99075	Rubber Helmet Strap

DUALIE® 3AA

One light, two beams: choose one spot beam or one flood light or both. The 3AA Dualie® provides two types of illumination for multi-directional lighting and special uses. Intuitive activation allows you to use either beam or both at the same time. This intrinsically safe flashlight allows you to see your entire work area and helps you avoid slips, trips, and falls.

	SPOT	FLOOD	COMBINED
LUMENS:	140	140	245
CANDELA:	7,300	80	—
DISTANCE:	171m	18m	—
RUN TIME:	18h	18h	9h



Features a forward facing LED spot beam and a side facing LED flood light that can be used individually or at the same time for enhanced safety.

SGS
Class I & II, Div. I, Groups A, B, C, D, E, F, G;
Class III, CL I, ZN O, IIC
T-Code: T4; Exia

DUALIE 3AA

BATTERY: 3 “AA” size alkaline
SIZE: 7.00" x 1.86" x 1.06" (17.78 x 3.86 x 2.69 cm)
WEIGHT: 6.8 oz (193 g)
COLOR: Yellow or Black

YELLOW BLACK

68750	68752	White LED/alkaline batteries
68751	68753	White LED/without batteries – Box

ACCESSORIES

68089	Poly Mount Kit
99075	Rubber Helmet Strap
68085	Helmet Mount

MSHA
Permissible Flashlight
App. No. 20-A160001-0
Tested for use in methane-air mixtures only

DUALIE SERIES: DOUBLE THE FUNCTIONALITY

DUALIE® 3AA MAGNET

The Dualie® 3AA Magnet features all the great versatility and attributes of the standard Dualie 3AA but also incorporates two magnets into its integrated, non-protruding spring loaded belt clip for hands-free use.

	SPOT	FLOOD	COMBINED
LUMENS:	140	140	245
CANDELA:	7,300	80	—
DISTANCE:	171m	18m	—
RUN TIME:	18h	18h	9h



Integrated magnet for hands-free use



Features a forward facing LED spot beam and a side facing LED flood light that can be used individually or at the same time for enhanced safety.



Class I & II, Div. I, Groups A, B, C, D, E, F, G
Class III, CL I, ZN O, IIC
T-Code: T4; Exia



Permissible Flashlight
App. No. 20-A16001-0
Tested for use in methane-air mixtures only

DUALIE 3AA MAGNET

BATTERY: 3 "AA" size alkaline

SIZE: 7.50" x 1.86" x 1.06" (19.05 x 3.86 x 2.69 cm)

WEIGHT: 7.1 oz (201 g)

COLOR: Yellow or Black

YELLOW BLACK

68780	68781	White LED/alkaline batteries, lanyard
68782	68783	White LED/alkaline batteries, lanyard—Box

ACCESSORIES

68089	Poly Mount Kit
99075	Rubber Helmet Strap
68085	Helmet Mount

DUALIE® 3AA LASER

The Dualie® 3AA Laser is an intrinsically safe, high performance, battery powered multi-function LED flashlight. The Dualie Laser model features forward facing LED spot beam and laser pointer that can be used individually or at the same time for location identification. Opposing switches for easy user activation of desired functions.

	LED	LASER	COMBINED
LUMENS:	150	<5mW	—
CANDELA:	7,700	—	—
DISTANCE:	175m	—	—
RUN TIME:	17h	70h	12h



Simultaneous spot beam and laser pointer allow you to illuminate the work area and pinpoint out-of-reach objects.



Class I & II, Div. I, Groups A, B, C, D, E, F, G
Class III, CL I, ZN O, IIC
T-Code: T4; Exia



Permissible Flashlight
App. No. 20-A16001-0
Tested for use in methane-air mixtures only

DUALIE 3AA LASER

BATTERY: 3 "AA" size alkaline

SIZE: 7.00" x 1.86" x 1.06" (17.78 x 3.86 x 2.69 cm)

WEIGHT: 6.8 oz (193 g)

COLOR: Yellow or Black

YELLOW BLACK

68760	68762	White LED/Laser/alkaline batteries
-------	-------	------------------------------------

ACCESSORIES

68089	Poly Mount Kit
99075	Rubber Helmet Strap

**STREAMLIGHT
PROPOLYMER SERIES**



2AAA PROPOLYMER® HAZ-LO®

The 2AAA ProPolymer® HAZ-LO® is an extremely durable, alkaline battery-powered, intrinsically safe flashlight. This light offers a push-button tailswitch for momentary on or on-off operation and integrated pocket clip.

2AAA PROPOLYMER HAZ-LO

BATTERY: 2 "AAA" size alkaline

SIZE: 5.40" x 1.00" x .66"
(13.7 x 2.5 x 1.7 cm)

WEIGHT: 1.9 oz (54 g)

COLOR: Yellow or Black

66500	2AAA HAZ-LO with alkaline batteries – Clam – Yellow
66505	2AAA HAZ-LO with alkaline batteries – Box – Yellow
66501	2AAA HAZ-LO with alkaline batteries – Clam – Black
66506	2AAA HAZ-LO with alkaline batteries – Box – Black

ACCESSORIES

Nylon Holster	66029
---------------	-------

LUMENS:	60
CANDELA:	800
DISTANCE:	57m
RUN TIME:	16h



Class I, II, Division 1, Groups A, B, C, D, E, F, G;
Class III; CL I, ZN O, IIC; T-Class: T4A

2AA PROPOLYMER® HAZ-LO®

This virtually indestructible safety-rated flashlight is big on brightness and long on run time, but small enough to fit in a pocket or even strap on a helmet. Provides a focused beam with optimum peripheral illumination. O-ring sealed construction. IPX7 rated waterproof to 1 meter for 30 minutes.

2AA PROPOLYMER HAZ-LO

BATTERY: 2 "AA" size alkaline

SIZE: 6.4" x 1.32" x .89"
(16.26 x 3.35 x 2.26 cm)

WEIGHT: 3.6 oz (100 g)

COLOR: Yellow or Black

67101	2AA HAZ-LO with alkaline batteries – Yellow
67100	2AA HAZ-LO with alkaline batteries – Black

ACCESSORIES

Rubber Helmet Strap	99075
Red Safety Wand	74903
Yellow Safety Wand	74904
Glow-In-The-Dark Safety Wand	74913
Nylon Holster	85905
Polymount Kit	68089

LUMENS:	65
CANDELA:	2,300
DISTANCE:	96m
RUN TIME:	24h



Class I, II, Division 1, Groups A, B, C, D, E, F, G;
Class III; T-Class: T4



Permissible Flashlight. Approval No. 20-A140002-0.
Tested for Intrinsic Safety in Methane-Air mixtures only.



Rubber
Helmet
Strap

STREAMLIGHT STORIES...

“MY 4AA PROPOLYMER MELTED & MUTATED. BUT IT STILL WORKS!”

Your flashlights are amazing! I was using a 4AA ProPolymer along with a torch for preheating. The light got too close to the torch, the torch melted the flashlight ... but it still works! Thanks and please continue making great durable products.

Jason Palmer
Alberta, Canada

4AA PROPOLYMER® LED

Its soft, diffused light is perfect for up close work, and with 155 hrs. of run time, this safety-rated light is always ready. Contains seven ultra-bright LEDs. IP65 rated, waterproof, dust-resistant. Unbreakable, scratch-resistant lens.

- 4AA PROPOLYMER LED**
- BATTERY:** 4 “AA” size alkaline
- SIZE:** 6.5” x 1.63” x 1.34”
(16.51 x 4.14 x 3.4 cm)
- WEIGHT:** 6.3 oz (178.6 g)
- COLOR:** Yellow or Black

YELLOW BLACK

68202	68302	White LEDs/alkaline batteries – Clam packaged
68201	68301	White LEDs/alkaline batteries – in box
68200	68300	White LEDs w/o alkaline batteries – in box

LUMENS: 67
RUN TIME: 155h



Class I, Div. 1, Groups C, D;
Class I, Div 2, Groups A, B, C, D;
Class II, Div. 2, Groups F&G;
Class III, T3C



Class I, Div. 2, Groups A, B, C, D;
Class II, Div. 2, Groups F&G;
Class III, T3C



Permissible Flashlight
App. No. 10C-658-0
Tested for use in methane-air
mixtures only

4AA PROPOLYMER® LUX

This safety-rated light has a long-reaching, bright beam and an ergonomic design for comfortable handling. Unbreakable, scratch-resistant lens. IP67 rated; waterproof to 1 meter for 30 minutes. 1 meter impact-resistance tested. Corrosion-proof.

- 4AA PROPOLYMER LUX**
- BATTERY:** 4 “AA” size alkaline
- SIZE:** 7” x 1.48” x 1.69”
(17.8 x 3.76 x 4.29 cm)
- WEIGHT:** 7.6 oz (216 g)
- COLOR:** Yellow or Black

YELLOW BLACK

68244	68344	4AA Lux Div. 2 w/alkaline batteries
68602	68702	4AA Lux Div. 1 w/alkaline batteries

ACCESSORIES

Yellow Safety Wand	75904
Red Safety Wand	75903
Blue Safety Wand	75902
White Safety Wand	75908
Glow-In-The-Dark Safety Wand	75913
Helmet Mount	68085
Polymount Kit	68089

LUMENS: 100
CANDELA: 4,200
DISTANCE: 130m
RUN TIME: 6h



4AA Lux Div. 1



Class I & II, Div. 1, Groups C, D, F & G;
Class I, Div. 2, Groups A, B, C, D;
Class III, T4



Class I & II, Div. 1, Groups C, D, F & G;
Class III, T4 Exia
Non-incendive:
Class I, Div. 2, Groups A, B, C, D



Permissible Flashlight
App. No. 20-A060002-0
Tested for use in methane-air
mixtures only

4AA Lux Div. 2



Class I, Div. 2, Groups A, B, C, D;
Class II, Div. 2, Groups F&G;
Class III, T3C (142 C)



Class I, Div. 2, Groups A, B, C, D;
Class II, Div. 2, Groups F&G;
Class III, T3C (142 C)



Safety Wands



Helmet Mount



Helmet Mount



Rubber Helmet Strap

4AA PROPOLYMAX®

The brightest light in our ProPolymer® series stands up to the toughest environments. Produces a tight beam with optimum peripheral illumination. Can be used with a belt clip or attaches to a hard hat. Sealed switch design protects it from corrosion caused by battery leakage. Unbreakable, scratch-resistant lens. Features TEN-TAP® programming, allowing user to select the order in which light modes come on. IP67 rated for dust-tight and waterproof to 1 meter for 30 minutes. IPX4 for water spray. Non conductive; corrosion-proof.

4AA PROPOLYMAX

BATTERY: 4 "AA" size alkaline

SIZE: 7" x 1.05" x 1.5"
(17.78 x 2.67 x 3.81 cm)

WEIGHT: 8.2 OZ (233 g)

COLOR: Yellow, Black or Orange

68820	with alkaline batteries - Yellow
68821	with alkaline batteries - Black
68822	with alkaline batteries - Orange

ACCESSORIES

68088	Belt Clip - fits 4AA ProPolymax
68089	Poly Mount Kit - universal mounting via MSA V-Gard slot or self-adhesive mount



Class I, Div. 2, Groups A, B, C, D;
Class II, Div. 2, Groups F&G;
Class III, T4



Class I, Div. 2, Groups A, B, C, D;
Class II, Div. 2, Groups F&G;
Class III, T4



	HIGH	LOW
LUMENS:	300	50
CANDELA:	17,000	2,500
DISTANCE:	261m	100m
RUN TIME:	2h 45m	24h

Strobe runs 6 hours

TEN-TAP® Programmable switch allows user selection of one of three different programs:

- high/low/strobe (factory default)
- high only
- low/high

Belt Clip

Poly Mount Kit

3C PROPOLYMER® LED

10 ultra-bright LEDs provide lots of bright white light and an extended run time - up to 336 hrs! Safety-rated for use in hazardous locations. Unbreakable, scratch-resistant lens. Waterproof.

3C PROPOLYMER LED

BATTERY: 3 "C" size alkaline

SIZE: 8.55" x 1.95" x 1.48"
(21.72 x 4.95 x 3.76 cm)

WEIGHT: 13.5 OZ (382.73 g)

COLOR: Yellow or Black

33202	White LEDs w/o alkaline batteries - Yellow
33302	White LEDs w/o alkaline batteries - Black

ACCESSORIES

33903	Red Wand
33908	White Wand
25090	Holster

LUMENS:	85
RUN TIME:	336h



Permissible Flashlight
App. No. 10C-658-0
Tested for use in methane-air mixtures only



Class I, Div. 1, Group D;
Class I, Div. 2, Groups A, B, C, D;
Class II, Div. 2, Groups F&G;
Class III, T3A



Class I, Div. 2, Groups A, B, C, D;
Class II, Div. 2, Groups F&G;
Class III, T3A





3C PROPOLYMER® HAZ-LO®

An intrinsically safe, high-performance flashlight for hazardous locations. Produces a smooth, uniform beam with optimum peripheral illumination. Virtually indestructible body. Resistant to chemicals and solvents. Sealed switch design protects it from corrosion caused by battery leakage. Unbreakable, scratch-resistant lens. 3 meter impact-resistance tested. IP67 rated for dust-tight and waterproof to 1 meter for 30 minutes. IPX4 for water spray. Anti-static and non-conductive.

3C PROPOLYMER HAZ-LO

BATTERY: 3 "C" size alkaline

SIZE: 9.3" x 1.46" x 2.08"
(23.62 x 3.71 x 5.28 cm)

WEIGHT: 13.9 OZ (394 g)

COLOR: Yellow or Orange

33820 3C ProPolymer HAZ-LO - Yellow

33822 3C ProPolymer HAZ-LO - Orange

ACCESSORIES

25090 Holster

LUMENS:	150
CANDELA:	7,000
DISTANCE:	167m
RUN TIME:	18h



Permissible Flashlight
App. No. 20-A130003-0
Tested for Intrinsic Safety in
Methane-Air mixtures only



Class I, Div 1, Groups A, B, C, D;
Class II, Div. 1, Groups E, F, G;
Class III, T4 Exia



3AA PROPOLYMER® HAZ-LO®

The 3AA ProPolymer HAZ-LO features a strong blend of performance and safety ratings. Intrinsically safe for use in hazardous locations. Produces a tight beam with optimum peripheral illumination. Resistant to chemicals and solvents. Combination of visual and mechanical polarity protection ensures correct installation of batteries. Consistent performance throughout battery life. Unbreakable, scratch-resistant lens. IP67 rated for dust-resistance. Waterproof to 1 meter for 30 minutes.

3AA PROPOLYMER HAZ-LO

BATTERY: 3 "AA" size alkaline

SIZE: 7.0" x 1.05" x 1.50"
(17.78 x 2.67 x 3.81 cm)

WEIGHT: 7.5 oz (213 g)

COLOR: Yellow, Black or Orange

YELLOW BLACK ORANGE

68720	68721	68722	HAZ-LO with alkaline batteries - Clam
68723	68724	—	HAZ-LO with alkaline batteries - Box
68270	—	—	Helmet Lighting Kit- 3AA HAZ-LO with white LED, alkaline batteries, helmet mount, helmet band, clam packaged

ACCESSORIES

68085	Helmet Mount
68089	Polymount Kit
68088	Belt Clip

LUMENS:	120
CANDELA:	14,000
DISTANCE:	237m
RUN TIME:	6h 30m



Helmet Mount



Helmet Lighting Kit



Permissible Flashlight
App. No. 20-A140003-0
Tested for Intrinsic Safety in
Methane-Air mixtures only



Class I, Div 1, Groups A, B, C, D;
Class II, Div 1, Groups E, F, G;
Class III, T4 Exia

THESE LIGHTS ARE ALWAYS READY FOR HAZARDOUS DUTY.

3N PROPOLYMER® LED

Lightweight, alkaline battery-powered personal light with 3 ultra-bright LEDs. Long run time. Impact-resistant body and face cap. Unbreakable, polycarbonate scratch-resistant lens. Push-button tail switch for momentary and on-off operation.

3N PROPOLYMER LED

BATTERY: 3 "N" size alkaline

SIZE: 5.25" x .96" x .69"
(13.33 x 2.44 x 1.75 cm)

WEIGHT: 2.1 OZ (59.54 g)

COLOR: Yellow or Black

62202 White LEDs and alkaline batteries — Yellow

62302 White LEDs and alkaline batteries — Black

POLYSTINGER® LED HAZ-LO®

If you need a Class 1, Div. 1 rated light with the cost savings of a rechargeable, the PolyStinger LED HAZ-LO is the light you need. Not only does it provide a bright-white light, it is also intrinsically safe and has an unbreakable, scratch resistant lens. It's O-ring sealed and is IPX4 rated for water resistance and is 3 meter impact resistance tested.

POLYSTINGER LED HAZ-LO

BATTERY: NiCd

SIZE: 10.2" x 1.76" x 1.34"
(25.9 x 4.47 x 3.4 cm)

WEIGHT: 13.5 OZ (382 g)

COLOR: Black or Yellow

YELLOW BLACK

76412 76442 120V AC/12V DC

76411 76441 12V DC

76410 76440 Without Charger

ACCESSORIES

76409 Lanyard

75928 Loop Holster

75906 Ring Holder

76375 NiCd Battery Stick

75400 5 Unit Bank Smart Charger 120V

75103 Charger Holder Fast Charge (2.5 hr)

75105 Charger Holder Stinger (10 hr)

22060 120V AC Charge Cord

22051 DC1 Charge Cord

22050 DC2 Direct Wire Charge Cord

LUMENS:	30
CANDELA:	300
DISTANCE:	35m
RUN TIME:	10h



Class I, II, Div. 1, Groups A,B,C,D,E,F,G;
Class III, Exia, T4A Classified



TRADITION SERIES

	HIGH	LOW
LUMENS:	130	50
CANDELA:	15,000	5,700
DISTANCE:	245m	151m
RUN TIME:	4h	12h

Moonlight mode: 20 days of continuous run time



Lanyard Ring
with lanyard for tail cap.



Class I & II, Division 1, Groups C,D,F,G;
Class I, Division 2, Groups A,B,C,D.;
Class III; 138 C, T-Code: T3C

Special Features:

- Non-conductive, corrosion-resistant body.
- IPX4-rated for water-resistance.
- 3 meter impact-resistance tested.



THE HARD WORKING
**KNUCKLEHEAD...
 CLASS 1. DIV. 1 RATED.**

STREAMLIGHT HAZ-LO® SERIES: // WHAT IS “INTRINSICALLY SAFE?”

Streamlight offers a variety of lights that are safety-rated for hazardous environments. We even have several lights that are “intrinsically safe” – these are lights that have been tested to ANSI/U.L.- Std-913 and found to be safe for use in a Division 1 classified environment.



KNUCKLEHEAD ACCESSORIES

Battery Chargers	Fits All	Battery Packs	Fits All	Charge Cords	PN
Smart Charger Holder	90116	Alkaline Battery Cartridge	90542	120V AC	22060
AC Fast Charger (Includes Holder)	90011	Battery Pack Assembly – LED Div. 1	90335	12V DC Cigarette Lighter	22051
DC#1 Cigarette Lighter Cord/Fast Charger (Includes Holder)	90012	Battery Pack Assembly – LED Div. 2	90338	12V DC Direct Wire	22050
DC#2 Direct Wire Cord/Fast Charger (Includes Holder)	90013				
120V AC Bank Charger	90400				
12V DC Bank Charger	90401				

KNUCKLEHEAD® HAZ-LO® FLOOD

Class I & II, Div. 1 safety-approved work light with articulating head that hangs or attaches a variety of ways. Its soft flood pattern with 2 LEDs illuminates your work area, yet the beam is easy on your eyes. Articulating head rotates 210°. Includes high, low, moonlight and flash modes. Removable magnet. Yellow model features an integrated hook for hands-free use. Orange model has a clip that clamps to objects or turn-out gear. IPX4 rated for water-resistance. 2 meter impact-resistance tested.

KNUCKLEHEAD HAZ-LO FLOOD

BATTERY: Dual power source: accepts rechargeable NiCd battery pack or (4) "AA" alkaline batteries

SIZE: 9.2" x 2.85" x 2.75"
(23.4 x 7.2 x 7 cm)

NiCd WEIGHT: 1 lb 7.1 oz (655 g)

ALKALINE WEIGHT: 1 lb 2.3 oz (519 g)

COLOR: Orange or Yellow

YELLOW ORANGE

91627	91657	Charger/Holder and 120V AC & 12V DC cords
91622	91652	120V AC
91621	91651	without Charger
91642	91644	Alkaline Model

	HIGH	LOW
LUMENS:	150	55
CANDELA:	12,900	4,300
DISTANCE:	227m	131m
RUN TIME:	3h 30m	12h

Moonlight mode: 20 days of continuous run time
Flash: 8 hours continuous time



Permissible Flashlight
App. No. 20-A140001-0



Class I & II Division 1, Groups C,D,F,G;
Class III; T-Code: T4; Exia;
Non-Incendive: Class I, II, III Division 2;
Groups A,B,C,D,F,G
T-CODE: T4

NFPA

Rack meets requirements
of 1901-14.10.2 (2016)
mounted in any position



	HIGH	LOW
LUMENS:	163	50
CANDELA:	730	230
DISTANCE:	54m	30m
RUN TIME:	3h 45m	12h

Moonlight mode: 20 days of continuous run time
Flash: 8 hours continuous time



Permissible Flashlight
App. No. 20-A140001-0



Class I & II Division 1, Groups C,D,F,G;
Class III; T-Code: T4; Exia;
Non-Incendive: Class I, II, III Division 2;
Groups A,B,C,D,F,G
T-CODE: T4

NFPA

Rack meets requirements
of 1901-14.10.2 (2016)
mounted in any position



KNUCKLEHEAD® HAZ-LO® SPOT

Class I & II, Div. 1 safety-approved for hazardous locations. Far-reaching beam helps locate hazards or victims from a distance. Articulating head makes it easy to aim light where it's needed. 4 light modes include a flash for signaling and a moonlight mode for 20-day runtime. Hangs or attaches various ways. Powerful, removable magnet. Yellow model features an integrated hook for hands-free use. Orange model has a clip that clamps to objects or turn-out gear. IPX4 rated for water-resistance. 2 meter impact-resistance tested.

KNUCKLEHEAD HAZ-LO SPOT

BATTERY: Dual power source: accepts rechargeable NiCd battery pack or (4) "AA" alkaline batteries

SIZE: 9.2" x 2.85" x 2.75"
(23.4 x 7.2 x 7 cm)

NiCd WEIGHT: 1 lb 7.1 oz (655 g)

ALKALINE WEIGHT: 1 lb 2.3 oz (519 g)

COLOR: Orange or Yellow

YELLOW ORANGE

91727	91757	Charger/Holder and 120V AC & 12V DC cords
91722	91752	120V AC
91721	91751	without Charger
91742	91744	Alkaline Model

STREAMLIGHT
SAFETY-RATED HEADLAMP SERIES

ARGO® HAZ-LO®

With its intense, long-distance beam that reaches as far as 113 meters, and its Class 1, Division 1 safety rating, the Argo® HAZ-LO® headlamp is ideal any where you need hands-free lighting, even in hazardous environments. Intrinsically safe and offers 3 lighting modes and a 90° tilting head. Unbreakable lens. IPX4 rated for water-resistance. 2 meter impact-resistance tested.

ARGO HAZ-LO HEADLAMP

BATTERY: (3) "AAA" alkaline

SIZE: 1.75" x 2.70" x 2.40"
(4.45 x 6.85 x 6.09 cm)

WEIGHT: 5.4 OZ (153 g)

COLOR: Yellow



Class 1, Division 1, Groups A,B,C,D;
Class II, Division 1, Groups E,F,G;
Class III, T-Class: T4 Exia

61026 with alkaline batteries—rubber and elastic straps—Yellow



Includes a rubber head strap that ensures a non-slip grip for hard hats.

	HIGH	LOW
LUMENS:	90	20
CANDELA:	3,200	700
DISTANCE:	113m	53m
RUN TIME:	8h	50h

90° tilting head with a durable ratcheting system.



SEPTOR® HAZ-LO®

The perfect headlamp for close-up tasks or tasks at arm's length is now safe to use in hazardous locations and is intrinsically safe. 90° tilting head. High and low lighting modes. Unbreakable lens. IPX4 rated for water-resistance. 2 meter impact-resistance tested.

SEPTOR HAZ-LO HEADLAMP

BATTERY: (3) "AAA" alkaline

SIZE: 1.75" x 2.70" x 2.40"
(4.45 x 6.85 x 6.09 cm)

WEIGHT: 5.5 OZ (156 g)

COLOR: Yellow



Class 1, Division 1, Groups A,B,C,D;
Class II, Division 1, Groups E,F,G;
Class III, T-Class: T4 Exia

61024 with alkaline batteries—rubber and elastic straps—Yellow



Includes a rubber head strap that ensures a non-slip grip for hard hats.

	HIGH	LOW
LUMENS:	85	20
CANDELA:	620	150
DISTANCE:	50m	24m
RUN TIME:	8h	50h

90° tilting head with a durable ratcheting system.



TRIDENT® HAZ-LO®

Safely use this multi-purpose headlamp in hazardous environments. The Class 1, Division 1 safety-rated Trident® HAZ-LO® headlamp is intrinsically safe and gives you the versatility to switch between a bright power LED to illuminate objects at a distance (102 meters!) or a soft flood light for close-up tasks. 90° tilting head. Unbreakable lens. IPX4 rated for water-resistance. 2 meter impact-resistance tested.

TRIDENT HAZ-LO HEADLAMP

BATTERY: (3) "AAA" alkaline

SIZE: 1.75" x 2.70" x 2.40"
(4.45 x 6.85 x 6.09 cm)

WEIGHT: 5.50 OZ (156 g)

COLOR: Yellow



Class 1, Division 1, Groups A,B,C,D;
Class II, Division 1, Groups E,F,G;
Class III, T-Class: T4 Exia

61025 with alkaline batteries—rubber and elastic straps—Yellow



Includes a rubber head strap that ensures a non-slip grip for hard hats.

	HIGH	LOW
LUMENS:	85	30
CANDELA:	2,600	300
DISTANCE:	102m	35m
RUN TIME:	8h	24h

90° tilting head with a durable ratcheting system.



STREAMLIGHT OFFERS A FULL-LINE OF HAZ-LO HEADLAMPS ALL

CLASS 1, DIV. 1 SAFETY-RATED.

3AA HAZ-LO® HEADLAMP

LUMENS:	120
CANDELA:	6,800
DISTANCE:	165m
RUN TIME:	11h



Includes a rubber head strap that ensures a non-slip grip for hard hats.

90° tilting head.



This compact, long-running, high-performance headlamp meets the stringent requirements of Div. 1 hazardous locations. Exceptional light output. Long run time. Unbreakable, O-ring sealed lens. Easy operation even when wearing heavy gloves. Impact-resistant housing – 1 meter drop-test verified. Intrinsically safe.

3AA HAZ-LO

BATTERY: (3) "AA" alkaline

SIZE: 1.88" x 2.5" x 3.08"
(4.76 x 6.35 x 7.82 cm)

WEIGHT: 7.1 OZ (202 g)

COLOR: Yellow

61200 with alkaline batteries—rubber and elastic straps—Yellow



Class I, Div. 1, Groups A, B, C, D;
Class II, Div. 1, Groups E, F, G;
Class III, T4



Permissible Portable Headlamp Assembly
App. No. 20-A070001-0
Tested for use in methane-air mixtures only



Includes a rubber head strap that ensures a non-slip grip for hard hats.

ENDURO® PRO HAZ-LO®



	SPOT	FLOOD	SPOT/FLOOD COMBO
LUMENS:	160	160	235
CANDELA:	1,320	100	—
DISTANCE:	73m	20m	—
RUN TIME:	5h	5h	4h 45m

This intrinsically safe, high performance 3 "AAA" battery powered headlamp features two power LEDs. There are a total of three output modes, Spot, Flood and Spot/Flood Combo for maximum brightness. The flood LED is strategically placed high on the light for shadow free lighting when mounted on a hard hat.

ENDURO PRO HAZ-LO HEADLAMP

BATTERY: (3) "AAA" alkaline

SIZE: 2.0" x 2.19" x 1.5"
(5.08 x 5.68 x 3.81 cm)

WEIGHT: 3.5 OZ (99.2 g)

COLOR: Yellow

61424 with elastic headstrap, rubber hard hat strap,
3M® Dual Lock® reclosable fasteners—Yellow



Class 1, Division 1, Groups A, B, C, D;
Class II, Division 1, Groups E, F, G;
Class III, T-Class: T4 Exia



Includes 3M® Dual Lock® reclosable fasteners and a rubber head strap that ensures a non-slip grip for hard hats.

WEAPON-MOUNTED SERIES //



WEAPON-MOUNTED LIGHTING SPECIALISTS

WE BUILD A RANGE OF LIGHTS FOR LONG GUN,
FULL-FRAME, COMPACT & SUB-COMPACT PISTOLS.

Streamlight proudly builds our full line of weapon-mounted lights with features and performance levels to fill the needs of military, law enforcement, concealed carry and sportsmen. From IR to high-lumen to laser, Streamlight TLRs lead the industry.



TLR-6®



TLR-1 HL®

PROTAC® RAIL MOUNT 2



STREAMLIGHT TLRs

THE WIDEST RANGE OF WEAPON-MOUNTED LIGHTS



Streamlight produces a full line of weapon-mounted lights with the features that law enforcement, conceal & carry, and sportsmen need: high-lumen, laser, and IR. Models to fit long guns and full-size and compact pistols.

LIGHT ONLY

COMPACT & FULL FRAME PISTOLS

UNIVERSAL RAIL MOUNT MODELS



NEW
TLR-7®
WHITE LIGHT ILLUMINATOR



TLR-1 HL®
WHITE LIGHT ILLUMINATOR



TLR-1®
TLR-1®s
WHITE LIGHT ILLUMINATOR



TLR-3®
WHITE LIGHT ILLUMINATOR

SUB-COMPACT & COMPACT PISTOLS

TRIGGER GUARD & RAIL MOUNT MODELS



NEW
TLR-7®
WHITE LIGHT ILLUMINATOR



TLR-3®
WHITE LIGHT ILLUMINATOR



NEW
TLR-6® NON-LASER
WHITE LIGHT ILLUMINATOR

LONG GUN / AR

RAIL MOUNT MODELS



TLR-1 HL®
[Long Gun Kit]
WHITE LIGHT ILLUMINATOR



PROTAC®
RAIL MOUNT 2
WHITE LIGHT ILLUMINATOR



PROTAC®
RAIL MOUNT 1
WHITE LIGHT ILLUMINATOR



PROTAC®
RAIL MOUNT HL-X
WHITE LIGHT ILLUMINATOR



TLR-1 HPL®
[Long Gun Kit]
WHITE LIGHT ILLUMINATOR

SPECIALTY/IR

LONG GUN/AR & FULL FRAME PISTOLS



TLR-VIR®
[Long Gun Kit]
WHITE LIGHT ILLUMINATOR
// IR ILLUMINATOR



TLR-VIR® PISTOL
WHITE LIGHT ILLUMINATOR
// IR ILLUMINATOR



TLR-1® IR
IR ILLUMINATOR



LIGHT/LASER COMBO

NEW



TLR-8®
WHITE LIGHT ILLUMINATOR
// RED LASER



TLR-2® // TLR-2®s
WHITE LIGHT ILLUMINATOR
// RED LASER



TLR-2 HL®
WHITE LIGHT ILLUMINATOR
// RED LASER



TLR-2® G
WHITE LIGHT ILLUMINATOR
// GREEN LASER



TLR-2 HL® G
WHITE LIGHT ILLUMINATOR
// GREEN LASER

NEW



TLR-8®
WHITE LIGHT ILLUMINATOR
// RED LASER



TLR-6®
WHITE LIGHT ILLUMINATOR
// RED LASER



TLR-6® RAIL MOUNT
WHITE LIGHT ILLUMINATOR
// RED LASER



TLR-6® 1911
WHITE LIGHT ILLUMINATOR
// RED LASER



TLR-4®
WHITE LIGHT ILLUMINATOR
// RED LASER



TLR-4® G
WHITE LIGHT ILLUMINATOR
// GREEN LASER



TLR-2® // TLR-2®s
WHITE LIGHT ILLUMINATOR
// RED LASER



TLR-2 HL®
WHITE LIGHT ILLUMINATOR
// RED LASER



TLR-2 HL® G
WHITE LIGHT ILLUMINATOR
// GREEN LASER



TLR-2® IRW
WHITE LIGHT ILLUMINATOR
// EYE SAFE IR LASER



TLR-2® IR EYE SAFE
IR ILLUMINATOR
// EYE SAFE IR LASER

STREAMLIGHT
TACTICAL WEAPON-MOUNTED SERIES



TLR-8® RAIL MOUNTED LIGHT
 WHITE LIGHT ILLUMINATOR // RED LASER

Ultra-lightweight and low-profile, the TLR-8® weapon-mounted tactical light with integrated red aiming laser features the latest in LED technology. The light provides 1.5 hours of continuous runtime when in dual mode with the high power visible laser. Rail clamp is designed to rapidly attach/detach from the side of compact and full-frame weapons.

TLR-8

BATTERY: (1) 3V "CR123A" lithium

SIZE: 2.15" x 1.18" x 1.50"
 (5.46 x 2.98 x 3.81 cm)

WEIGHT: 2.64 oz (75 g)

COLOR: Black

500 LUMENS

LUMENS:	500
CANDELA:	4,300
DISTANCE:	131m
RUN TIME:	1h 30m

Laser mode: 18 hours of run time

69410	TLR-8 with red laser, rail locating keys and CR123A lithium battery - Box - Black
-------	---



Safe Off feature prevents accidental activation; saves batteries.



TLR-8 & TLR-7

ULTRA LOW-PROFILE. RAIL MOUNT LIGHTS

TLR-7® RAIL MOUNTED LIGHT

WHITE LIGHT ILLUMINATOR

The TLR-7® weapon-mounted tactical light is ultra-lightweight and low-profile, features the latest in LED technology and provides 1.5 hours of continuous runtime from a single lithium battery. Rail clamp is designed to rapidly attach/detach from the side of compact and full-frame weapons.

TLR-7

BATTERY: (1) 3V "CR123A" lithium
SIZE: 2.20" x 1.20" x 1.47"
 (5.58 x 3.04 x 3.73 cm)
WEIGHT: 1.16 oz (33 g)
COLOR: Black

500 LUMENS

LUMENS:	500
CANDELA:	4,300
DISTANCE:	131m
RUN TIME:	1h 30m

69420 TLR-7 with rail locating keys and CR123A lithium battery - Box -Black



Safe Off feature prevents accidental activation; saves batteries.





DIFFERENT KINDS OF BEAMS FOR DIFFERENT KINDS OF TASKS.

WANT TO SEE THESE BEAMS IN ACTION?
Visit Streamlight's www.beamdemo.com
and see the differences for yourself.

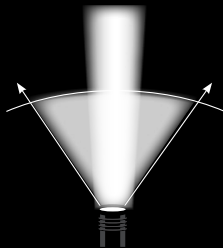

TRADITION^{SERIES}

This family of flashlights delivers the optimal balance of bright, far-reaching beam, ample peripheral light, and long run times. When you're out in the field or on any job that requires light for long periods, these are the flashlights you want by your side. Their brightness, power, performance, cost, and extended run times make them perfect for a variety of tasks.

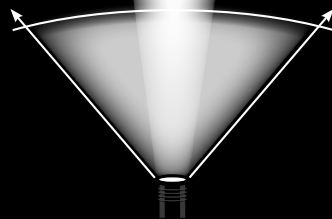

HPL^{SERIES}

These High Performance, High Lumen flashlights throw bright light a long distance. They have a bigger hot spot that casts more light on the target with more peripheral light. They're great for illuminating the entire length of a dark alley, for any task that requires a far-reaching beam.

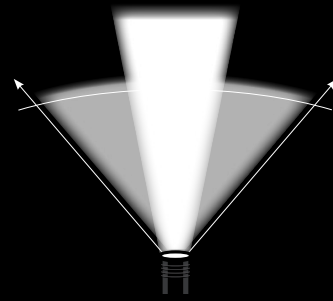

HL^{SERIES}

These High Lumen flashlights have a wide, side-to-side beam. They illuminate an entire area, including what may be hiding in corners. They perform like floodlights, illuminating a whole room, vehicle, or any area with bright, revealing light.

TLR HL FAMILY OF LIGHTS

HIGH-LUMEN DOMINATION THROUGH MAXIMUM ILLUMINATION.

TLR-1 HL®

WHITE LIGHT ILLUMINATOR

These versatile tactical lights fit handguns and long-guns, and you can switch from one to the other in seconds. Their wide peripheral beam lets you see what's all around you, including what's lurking in corners. Includes a strobe for signaling/disorienting. Unbreakable, scratch-resistant, gasket-sealed lens. Operates in temperatures from -40°F to +120°F. Impact resistant. Easy, fast battery installation/replacement. The TLR-1 HL is IPX7 rated waterproof to 1 meter for 30 minutes. TLR-2 HL features a 650-660nm red laser and IPX4-rated for water resistance.

TLR-1 HL

BATTERY: [2] 3V "CR123A" lithium

SIZE: 3.39" x 1.47" x 1.44"
(8.61 x 3.73 x 3.65 cm)

WEIGHT: 4.18 oz (118.6 g)

COLOR: Black, Flat Dark Earth or Flat Dark Earth Brown

TLR-2 HL®

WHITE LIGHT ILLUMINATOR // RED LASER

TLR-2 HL

BATTERY: [2] 3V "CR123A" lithium

SIZE: 3.39" x 1.47" x 1.83"
(8.61 x 3.73 x 4.64 cm)

WEIGHT: 4.78 oz (135.5 g)

COLOR: Black

TLR-1 HL	TLR-2 HL	
69260	69261	Includes Rail Locating Keys for use with Glock® style, 1913 Picatinny, S&W 99/TSW, and Beretta® 90two. Lithium batteries. Black.
69266	—	Includes Rail Locating Keys for use with Glock® style, 1913 Picatinny, S&W 99/TSW, and Beretta® 90two. Lithium batteries. Flat Dark Earth.
69267	—	Includes Rail Locating Keys for use with Glock® style, 1913 Picatinny, S&W 99/TSW, and Beretta® 90two. Lithium batteries. Flat Dark Earth Brown.
69262	—	Long Gun Kit includes: TLR-1 HL with thumb screw and "safe off" door switch, remote pressure switch and mounting clips, lithium batteries. For pistol mounting the kit also includes standard door switch, rail locating keys. Lithium batteries. Black.



HL® With **[(STROBE)]**
Double tap tailswitch to activate.

TLR-1 HL® Available in Flat Dark Earth and FDE Brown



TLR-1 HL Long Gun Kit

800 LUMENS HL SERIES

LUMENS: 800
CANDELA: 15,000
DISTANCE: 245m
RUN TIME: 1h 45m

TLR-2 HL Laser only made: 45 hours of run time



TLR-2 HL® G

WHITE LIGHT ILLUMINATOR // GREEN LASER

This light features a direct drive green laser and powerful high-lumen white LED. The green is clearly visible to guide your aim even in bright sunlight. You can count on the light and laser even in extreme temperatures from -40°F to +120°F. IPX4 rated for water resistance.

TLR-2 HL G

BATTERY: [2] 3V "CR123A" lithium

SIZE: 3.39" x 1.47" x 1.83" (8.61 x 3.73 x 4.64 cm)

WEIGHT: 4.78 oz (135.5 g)

COLOR: Black

69265	Includes Rail Locating Keys for use with Glock® style, 1913 Picatinny, S&W 99/TSW, and Beretta® 90two. Lithium batteries. Black.
-------	--

LUMENS: 800
CANDELA: 15,000
DISTANCE: 245m
RUN TIME: 1h 30m

Laser made: 17 hours of run time

800 LUMENS HL SERIES

HL® With **[(STROBE)]**
Double tap tailswitch to activate.



THE TLR-1 HPL... HIGH-LUMEN + LONG-DISTANCE SEE EVERYWHERE.

TLR-1 HPL®

WHITE LIGHT ILLUMINATOR

This high lumen, long-range, rail-mounted tactical light has an intensely bright, far-reaching beam with a large hotspot. It throws a wide beam to illuminate your target downrange, while illuminating everything in your path. Fits long-guns. Attaches/detaches with one hand in seconds. Includes a strobe for signaling/disorienting. Operates in extreme temperatures [-40°F to +120°F]. IPX7 rated. Impact-resistant. Easy, fast battery replacement.

TLR-1 HPL

BATTERY: (2) 3V "CR123A" lithium

SIZE: 4.83" x 1.44" x 2.2"
(12.27 x 3.66 x 5.59 cm)

WEIGHT: 5.3 oz (150.3 g)

COLOR: Black

TLR-1 HPL W/REMOTE

BATTERY: (2) 3V "CR123A" lithium

SIZE: 5.25" x 1.44" x 2.2"
(13.34 x 3.66 x 5.59 cm)

WEIGHT: 5.6 oz (158.8 g)

COLOR: Black

- | | |
|-------|---|
| 69215 | Standard model. Includes Rail Locating Keys for use with Glock® style, 1913 Picatinny, S&W 99/TSW, and Beretta® 90two. Lithium batteries. Black. |
| 69216 | Remote model. Includes Rail Locating Keys for use with Glock® style, 1913 Picatinny, S&W 99/TSW, and Beretta® 90two. Remote switch and Lithium batteries. Black. |
| 69219 | Long Gun Kit with thumbscrew, "Safe Off" door switch and remote pressure switch. Includes Rail Locating Keys for use with Glock® style, 1913 Picatinny, S&W 99/TSW, and Beretta® 90two. Lithium batteries. Black. |

LUMENS:	775
CANDELA:	48,000
DISTANCE:	438m
RUN TIME:	1h 45m

Shown with standard switch backplate.



Shown with "Safe Off" remote switch backplate.

With **[(STROBE)]**
Double tap tailswitch to activate.



TLR-1® GAME SPOTTER®

GREEN LIGHT ILLUMINATOR

LUMENS:	150
CANDELA:	31,000
DISTANCE:	350m
RUN TIME:	1h 45m

Shown with standard switch backplate.



Shown with remote switch backplate.

150 LUMENS HPL SERIES

A long-gun/long-range light with a green LED that preserves night vision and won't spook game. Mounts directly to long-guns with MIL-STD-1913 rails. Unbreakable, scratch-resistant, O-ring sealed lens. Operates in temperatures from -40°F to +120°F. IPX7 rated waterproof to 1 meter for 30 minutes. Impact resistant.

TLR-1 GAME SPOTTER

BATTERY: [2] 3V "CR123A" lithium

SIZE: 4.83" x 1.44" x 2.2"
(12.27 x 3.66 x 5.59 cm)

WEIGHT: 5.3 OZ (150.3 g)

COLOR: Black

TLR-1 GAME SPOTTER W/REMOTE

BATTERY: [2] 3V "CR123A" lithium

SIZE: 5.25" x 1.44" x 2.2"
(13.34 x 3.66 x 5.59 cm)

WEIGHT: 5.6 OZ (158.8 g)

COLOR: Black

69227 Standard model. Includes Rail Locating Keys for use with Glock® style, 1913 Picatinny, S&W 99/TSW, and Beretta® 90two. Lithium batteries. Black.

69228 Remote model. Includes Rail Locating Keys for use with Glock® style, 1913 Picatinny, S&W 99/TSW, and Beretta® 90two. Remote switch and Lithium batteries. Black.

THE TLR-2G... GREEN LASER FOR ALL CONDITIONS.

TLR-2® G

WHITE LIGHT ILLUMINATOR // GREEN LASER

The highly visible (even in daylight) green laser assists in target acquisition. Mounts directly to handguns with Glock®-style rails and to all MIL-STD-1913 rails. Operates in temperatures from -40°F to 120°F. IPX4 rated for water-resistance. Features a strobe that can be disabled.

TLR-2 G

BATTERY: (2) 3V "CR123A" lithium

SIZE: 3.39" x 1.47" x 1.83" (8.61 x 3.73 x 4.64 cm)

WEIGHT: 4.72 oz (133.8 g)

COLOR: Black

69250 Includes Rail Locating Keys for use with Glock® style, 1913 Picatinny, S&W 99/TSW, and Beretta® 90two. Lithium battery. Black.

LUMENS:	300
CANDELA:	12,000
RUN TIME:	2h 30m

Laser mode: 17 hours of run time

300 LUMENS TRADITION SERIES

With **[(STROBE)]**

Double tap tailswitch to activate.



Mounts directly to handguns with Glock®-style rails and to all MIL-STD-1913 (Picatinny) rails.

TLR TACTICAL LIGHTS

A TRADITION OF DURABILITY, POWER, & LONG RUN TIME.

TLR-1® // TLR-1®s

WHITE LIGHT ILLUMINATOR

Intensely bright, durable tactical light available in standard or strobe. Securely fits a broad range of weapons. Produces a concentrated beam with optimum peripheral illumination. Mounts directly to handguns with Glock®-style rails and to all MIL-STD-1913 rails. Operates in temperatures from -40°F to +120°F. IPX7 rated waterproof to 1 meter for 30 minutes. Impact resistant. The TLR-1s includes a strobe.

TLR-1 / TLR-1s

BATTERY: (2) 3V "CR123A" lithium

SIZE: 3.39" x 1.47" x 1.44" (8.61 x 3.73 x 3.65 cm)

WEIGHT: 4.18 oz (118.6 g)

COLOR: Black

69110	Includes Rail Locating Keys for use with Glock® style, 1913 Picatinny, S&W 99/TSW, and Beretta® 90two. Lithium batteries. Black.
69210	Strobe model includes Rail Locating Keys for use with Glock® style, 1913 Picatinny, S&W 99/TSW, and Beretta® 90two. Lithium batteries. Black.
69211	Strobe model with Earless Screw Kit, includes Rail Locating Keys for use with Glock® style, 1913 Picatinny, S&W 99/TSW, and Beretta® 90two. Lithium batteries. Black.

LUMENS:	300
CANDELA:	12,000
DISTANCE:	219m
RUN TIME:	2h 30m



300 LUMENS TRADITION SERIES

AVAILABLE WITH STROBE
With **[(STROBE)]**
Double tap tailswitch to activate.

LUMENS:	300
CANDELA:	12,000
DISTANCE:	219m
RUN TIME:	2h 30m

Laser mode: 48 hours of run time



300 LUMENS TRADITION SERIES

AVAILABLE WITH STROBE
With **[(STROBE)]**
Double tap tailswitch to activate.

TLR-2® // TLR-2®s

WHITE LIGHT ILLUMINATOR // RED LASER

The same great features as the TLR-1 lights with a 650-660nm red laser for accurate aiming. Strobe ["s"] model available.

TLR-2 / TLR-2s

BATTERY: (2) 3V "CR123A" lithium

SIZE: 3.39" x 1.47" x 1.83" (8.61 x 3.73 x 4.64 cm)

WEIGHT: 4.72 oz (133.8 g)

COLOR: Black

69120	with Red Laser. Includes Rail Locating Keys for use with Glock® style, 1913 Picatinny, S&W 99/TSW, and Beretta® 90two. Lithium batteries. Black.
69230	Strobe model w/ Red Laser. Includes Rail Locating Keys for use with Glock® style, 1913 Picatinny, S&W 99/TSW, and Beretta® 90two. Lithium batteries. Black.

TLR-2® IRW

WHITE LIGHT ILLUMINATOR // EYE SAFE IR LASER

Features a Class 1 “Eye Safe” Infrared laser along with a blinding bright white light for long-range targeting. User programmable strobe enable/disable. Mounts directly to handguns with Glock® style rails and to all MIL-STD-1913 rails. Operates in temperatures from -40°F to +140°F. IPX4 rated for water-resistance.

TLR-2 IRW

BATTERY: (2) 3V “CR123A” lithium

SIZE: 3.39" x 1.47" x 1.83" (8.61 x 3.73 x 4.64 cm)

WEIGHT: 4.72 oz (133.8 g)

COLOR: Black

69165 TLR-2 IRW. Includes Rail Locating Keys for use with Glock® style, 1913 Picatinny, S&W 99/TSW, and Beretta® 90two. Lithium batteries. Black.

LUMENS:	300
CANDELA:	12,000
IR LASER OUTPUT:	Less than .8mW
DISTANCE:	219m
RUN TIME:	2h 30m

Laser mode: 45+ hours of run time

300 LUMENS



TLR-2® IR EYE SAFE

IR ILLUMINATOR // EYE SAFE IR LASER

Lightweight, compact, lithium battery powered gun-mounted infrared active illuminator with Class 1 “Eye Safe” integrated IR aiming laser. The Illuminator features the latest in shock-proof high power infrared LED technology providing at least 7.5 hrs of continuous run time when in dual mode with the infrared laser. Rail clamp designed to rapidly attach/detach from side of weapon.

TLR-2 IR EYE SAFE

BATTERY: (2) 3V “CR123A” lithium

SIZE: 3.39" x 1.47" x 1.83" (8.61 x 3.73 x 4.64 cm)

WEIGHT: 4.72 oz (133.8 g)

COLOR: Black

69166 TLR-2 IR w/ Eye Safe Laser. Includes Rail Locating Keys for use with Glock® style, 1913 Picatinny, S&W 99/TSW, and Beretta® 90two. Lithium batteries. Black.

IR LED OUTPUT:	120mW
IR LASER OUTPUT:	Less than .8mW
IR RUN TIME:	7h 30m

IR Laser mode: 45+ hours of run time



TLR-1® IR

IR ILLUMINATOR

Lightweight, compact, lithium battery powered gun-mounted active illuminator featuring the latest in high power infrared LED technology. The illuminator is built with a shock-proof LED and provides at least 7.5 hours of continuous run time. Rail clamp designed to rapidly attach/detach from side of weapon.

TLR-1 IR

BATTERY: (2) 3V “CR123A” lithium

SIZE: 3.26" x 1.47" x 1.44" (8.28 x 3.73 x 3.65cm)

WEIGHT: 4.18 oz (118.6 g) with batteries

COLOR: Black

69150 TLR-1 IR. Includes Rail Locating Keys for use with Glock® style, 1913 Picatinny, S&W 99/TSW, and Beretta® 90two. Lithium batteries. Black.

IR OUTPUT:	125mW/sr
IR RUN TIME:	7h 30m



IR requires the use of [NVG] Night Vision Goggles. (Not Included)



STREAMLIGHT OFFERS A COMPLETE RANGE OF IR ILLUMINATORS AND LASERS FOR USE WITH NIGHT VISION GOGGLES.

TLR-VIR® PISTOL

WHITE LIGHT ILLUMINATOR // IR ILLUMINATOR

TLR-VIR PISTOL	
LUMENS:	300
CANDELA:	11,000
IR OUTPUT:	1000mW/sr
VISIBLE RUN TIME:	2h 30m
IR RUN TIME:	32h



Ambidexterous momentary steady-on-off switch

300 LUMENS

This combination bright white LED and infrared (IR) illuminator is designed for use with a pistol. It has a lower profile than the original TLR-VIR, and it's waterproof to 66 ft for 2 hours in its standard configuration. The IR illuminator is within the same lens as the white light. You can easily transition from white light to IR with a switch at the bottom of the light. There's no need to remove your eyes from the target or alter your firing grip. It has the standard momentary and constant-on ambidextrous switch as well.

TLR-VIR PISTOL

BATTERY: (2) 3V "CR123A" lithium

SIZE: 3.39" x 1.47" x 1.44" (8.61 x 3.73 x 3.65cm)

WEIGHT: 4.2 OZ (119 g) with batteries

COLOR: Black

69190 Includes rail locating keys for used with Glock® style, 1913 Picatinny, S&W 99/TSW, and Beretta® 90two. Lithium batteries. Black.

TLR-VIR®

WHITE LIGHT ILLUMINATOR // IR ILLUMINATOR

TLR-VIR	
LUMENS:	300
CANDELA:	12,000
IR OUTPUT:	1000mW/sr
VISIBLE RUN TIME:	2h 30m
IR RUN TIME:	20h



With [(STROBE)]
Double tap switch to activate.



300 LUMENS

Designed to be used with a long gun, includes both a white LED and an Infrared (IR) illuminator. Also features programmable strobe. Momentary/steady On-Off switch with plug port for momentary remote switch. Switch between white and IR as needed. Operates in temperatures from -40°F to +150°F. IPX7 rated waterproof to 1 meter for 30 minutes. Designed to fit all long guns with MIL-STD-1913 rails.

TLR-VIR

BATTERY: (2) 3V "CR123A" lithium

SIZE: 3.82" x 1.47" x 2.03" (9.70 x 3.73 x 5.16cm)

WEIGHT: 6.0 OZ (170 g) with batteries, retained lens cap and remote switch

COLOR: Black

69180 Includes opaque lens cover, remote switch, 1913 key. Lithium batteries. Black.

**TLR SERIES
ACCESSORIES**

At Streamlight, we engineer the highest performing, most rugged, durable and innovative lights on the market and the widest array of weapon mounted lights. Whether you're LEQ, S.W.A.T., Military, home defense or a sportsman, Streamlight builds the accessories you can depend on and the options and configurations that you need to accommodate all your weapon-mounted needs.

MOUNTS



GRIPS



KEY KIT



REMOTES

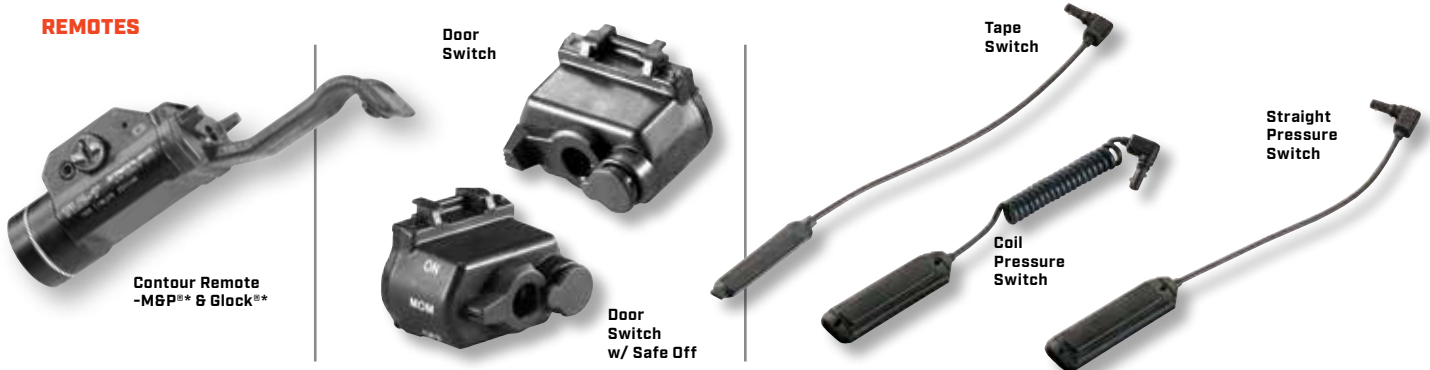

HOLSTERS





LENSES



BATTERIES



TLR SERIES ACCESSORIES

TLR Accessories	TLR-1 HL/ TLR-2 HL	TLR-2 HL G	TLR-2 G	TLR-1/ TLR-1s	TLR-2/ TLR-2s	TLR-2 IR EYE SAFE	TLR-2 IRW	TLR-1 IR	TLR-1 HPL	TLR-7	TLR-8	TLR-1 GAME SPOTTER
Remington 870 Mount 	69906	69906	69906	69906	69906	69906	69906	69906	69906	69906	69906	69906
TLR 12 ga. Mag Mount 	69901	69901	69901	69901	69901	69901	69901	69901	69901	69901	69901	69901
AR-15 M16 Mount 	69902	69902	69902	69902	69902	69902	69902	69902	69902	69902	69902	69902
Ambidextrous Vert. Grip w/Rail 	69114	69114	69114	69114	69114	69114	69114	69114	69114	—	—	69114
TLR Key Kit 	69175	69175	69175	69175	69175	69175	69175	69175	69175	—	—	69175
TLR-7 / TLR-8 Key Kit 	—	—	—	—	—	—	—	—	—	69177	69177	—
Nylon Holster 	1: 69201 2: 69202	69202	69202	69201	69202	69202	69202	69201	—	—	—	—
Contour Remote -Glock** 	69300	69300	69300	69300	69300	69300	69300	69300	—	—	—	—
Contour Remote -MSP* 	69310	69310	69310	69310	69310	69310	69310	69310	—	—	—	—
Door Switch 	69130	69130	69130	69130	69130	69130	69130	69130	69130	—	—	69130
Door Switch w/Safe Off 	69161	69161	69161	69161	69161	69161	69161	69161	69161	—	—	69161
Tape Switch 	69132	69132	69132	69132	69132	69132	69132	69132	69132	—	—	69132
Coil Pressure Switch 	69134	69134	69134	69134	69134	69134	69134	69134	69134	—	—	69134
Straight Press. Switch 	69135	69135	69135	69135	69135	69135	69135	69135	69135	—	—	69135
Red Flip Lens 	69115	69115	69115	69115	69115	—	69115	—	—	—	—	—
Blue Flip Lens 	69116	69116	69116	69116	69116	—	69116	—	—	—	—	—
Green Flip Lens 	69117	69117	69117	69117	69117	—	69117	—	—	—	—	—
IR Flip Lens 	69118	69118	69118	69118	69118	—	69118	—	—	—	—	—
Opaque Flip Lens 	69124	69124	69124	69124	69124	69124	69124	69124	—	—	—	—
CR123 Batteries 	2 Pk. // 85175 6 Pk. // 85180 12 Pk. // 85177 400 Pk. // 85179											
CR1/3N Batteries 	2 Pk. // 69271 6 Pk. // 69281 — For use in TLR-6											

*Note: Must be used in conjunction with 69130 remote door switch. Fits Glock® 17/22 and 19/23 size frames; or Smith & Wesson M&P frames.

TLR-6

ULTRA-COMPACT LIGHTS FOR COMPACT, SUB-COMPACT & CONCEALED CARRY WEAPONS.

TLR-6® FOR SUBCOMPACT HANDGUNS

An industry first, the ultra-compact TLR-6® weapon light with white LED and integrated 640/660 nm red aiming laser features tool-less battery replacement without removal from the weapon or the need to re-sight the laser. The light provides 1 hour of regulated runtime when in dual light/laser mode. Three operating modes — Light only / Light & laser / Laser only. Designed to securely attach to the trigger guard on hand guns. Durable, impact-resistant polymer construction; IPX4 water-resistant. 1 meter impact resistance tested.

TLR-6

BATTERY: [2] 3V CR-1/3 N lithium

SIZE:* 2.30" x .85" x 1.42"
(5.84 x 2.16 x 3.61 cm)

WEIGHT:* 1.27 oz (36 g)

COLOR: Black or Flat Dark Earth Brown

*Size & Weight vary by model. Glock® 42/43 listed.

100 LUMENS

LUMENS:	100
CANDELA:	2,000
DISTANCE:	89m
RUN TIME:	1h

Laser mode: 11 hours of run time

69270	TLR-6 (Glock® 42/43) with lithium batteries-Black
69278	TLR-6 (Glock® 42/43) with lithium batteries-Flat Dark Earth Brown
69272	TLR-6 (Glock® 26/27/33) with lithium batteries-Black
69273	TLR-6 (M&P Shield® 40/9) with lithium batteries-Black
69274	TLR-6 (KAHR® ARMS) with lithium batteries-Black
69275	TLR-6 (SIG SAUER® P238/P938) with lithium batteries-Black
69276	TLR-6 (KIMBER® Micro) with lithium batteries-Black
69277	TLR-6 Universal Kit-Black

ACCESSORIES

69271	CR 1/3N lithium batteries - 2 pk
69281	CR 1/3N lithium batteries - 12 pk



Model
#69273

Fits M&P Shield™ 40/9



Model
#69278

Fits Glock® 42/43
Flat Dark Earth Brown



Model #69278

Fits Glock® 42, Glock® 43



Model #69272

Fits Glock® 26, Glock® 27, Glock® 33



Model #69273

Fits M&P Shield® 40, M&P Shield® 9



Model #69274

Fits Kahr® Arms CT9, CW9, CM9, CT40, CW40, CM40, TP9, P9, PM9, TP40, P40 and PM40



Model #69275

Fits SIG SAUER® P238, SIG SAUER® P938



Model #69276

Fits KIMBER® Micro



Model #69277

Universal Kit includes LED/laser module and all TLR-6 body housings: Glock 42, Glock 26, M&P Shield, KAHR ARMS, SIG SAUER, KIMBER Micro. (Flat Dark Earth Brown and 1911 model not included.)

All Rights Reserved. M&P Shield®, GLOCK®, SIG SAUER®, KIMBER®, & KAHR® are registered trademarks of Smith & Wesson, Glock, Inc., SIG SAUER, KIMBER, IP LLC & Saeilo Enterprises, Inc. Streamlight has not sought endorsement of this product from Smith & Wesson®, GLOCK®, SIG SAUER®, KIMBER®, KAHR® Arms or Saeilo Enterprises, Inc.

TLR-6 RAIL MOUNT

THE IDEAL LIGHT & LASER FOR COMPACT, RAILED HANDGUNS

TLR-6® RAIL MOUNT // FOR COMPACT PISTOLS WITH RAILS

Designed to securely attach to the Rail and the trigger guard of GLOCK® compact railed handguns, Springfield Armory® XD®, XD(M)®, XD® MOD.2® and M&P® standard and compact railed handguns. The compact TLR-6® rail mount weapon light with LED and integrated red aiming laser features tool-less battery replacement without removal from the weapon or the need to re-sight the laser. The light provides 1 hour of regulated runtime when in dual light/laser mode.

TLR-6 RAIL MOUNT

BATTERY: [2] 3V CR-1/3 N lithium

SIZE: 2.20" x 1.20" x 1.47"
(5.58 x 3.04 x 3.73 cm)

WEIGHT: 1.16 oz (33 g)

COLOR: Black

100 LUMENS

LUMENS:	100
CANDELA:	2,000
DISTANCE:	89m
RUN TIME:	1h

Laser mode: 11 hours of run time



Model
#69290

Fits Glock® 17,
Glock® 19, Glock® 21

69290	TLR-6 Rail (Glock® 17/19/21) with lithium batteries-Black
69291	TLR-6 Rail (SA XD, XD (M), XD MOD 2) with lithium batteries-Black
69293	TLR-6 Rail (S&W M&P®) with lithium batteries-Black

ACCESSORIES

69271	CR 1/3N lithium batteries - 2 pk
69281	CR 1/3N lithium batteries - 12 pk



Model
#69290

Fits Glock® 17, Glock® 19,
Glock® 21



Model
#69291

Fits SA XD®, SA XD (M)®,
SA XD® MOD. 2®



Model
#69293

Fits S&W M&P®



TLR-6® NON-LASER

Based on our popular ultra-compact TLR-6® weapon light. This non-laser weapon-mounted light features tool-less battery replacement without removal from the weapon. The light provides 1 hour of regulated runtime. Designed to securely attach to the trigger guard on hand guns. Durable, impact-resistant polymer construction; IPX4 water-resistant. 1 meter impact resistance tested.

TLR-6 NON-LASER

BATTERY: [2] 3V CR-1/3 N lithium

SIZE:* 2.30" x .85" x 1.42"
(5.84 x 2.16 x 3.61 cm)

WEIGHT:* 1.27 oz (36 g)

COLOR: Black

100 LUMENS

LUMENS: 100

CANDELA: 2,000

DISTANCE: 89m

RUN TIME: 1h

*Size & Weight vary by model. Glock® 42/43 listed.



Model
#69280

Fits Glock® 42& Glock® 43

69280	TLR-6 (Glock® 42/43) with lithium batteries-Black
69282	TLR-6 (Glock® 26/27/33) with lithium batteries-Black
69283	TLR-6 (S&W) with lithium batteries-Black

ACCESSORIES

69271	CR 1/3N lithium batteries - 2 pk
69281	CR 1/3N lithium batteries - 12 pk



STREAMLIGHT
SUB-COMPACT WEAPON-MOUNTED SERIES



TLR-6 FOR NON-RAIL 1911

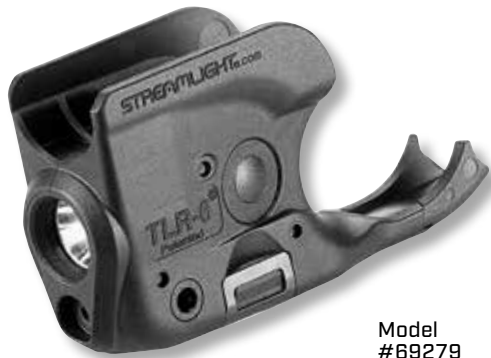

Model
#69279
Fits 1911

TLR-6® FOR NON-RAIL 1911 HANDGUNS

Add the compact performance of the TLR-6 to many non-rail 1911 handguns including: KIMBER®, Colt®, Ruger® and Smith & Wesson®. The ultra-compact TLR-6® weapon light with LED and integrated red aiming laser features tool-less battery replacement without removal from the weapon or the need to re-sight the laser. The light provides 1 hour of regulated runtime when in dual light/laser mode.

TLR-6 FOR NON-RAIL 1911

BATTERY: [2] 3V CR-1/3 N lithium

SIZE:* 2.34" x .085" x 1.58"
(5.94 x 2.16 x 4.01 cm)

WEIGHT: 1.27 oz (36 g)

COLOR: Black

100 LUMENS

LUMENS:	100
CANDELA:	2,000
DISTANCE:	89m
RUN TIME:	1h

Laser mode: 11 hours of run time

69279 TLR-6 (1911) with lithium batteries-Black

ACCESSORIES

69271 CR 1/3N lithium batteries - 2 pk

69281 CR 1/3N lithium batteries - 12 pk

**DESIGNED TO SECURELY
ATTACH TO THE TRIGGER
GUARD OF NON-RAIL 1911
HANDGUNS.**



Model
#69279
Fits 1911



TLR-6® COMPATABILITY LIST FOR NON-RAIL 1911 HANDGUNS

KIMBER®

Stainless Ultra Raptor II
Custom CDP
Pro CDP II
Ultra Crimson Carry
Custom TLE II
Pro Carry II
Pro Crimson Carry II

COLT®

1911-A1
1911 Commander
Competition 1911 Government
1991 A1 Government
Gold Cup® National Match
Delta Elite® 10mm
1911 Lightweight Commander

SIG SAUER®

1911 TacPac
1911 C3®
1911 Nitron®
1911 Ultra Compact

PARA® USA

Elite 1911
Expert Commoner
1911 LTC

REMINGTON®

1911 R1S

SMITH & WESSON®

SW 1911 Pro Series
SW 1911 CT
SW 1911 SC
SW 1911

SPRINGFIELD ARMORY®

1911 Range Officer®
1911 Range Officer® Compact

RUGER®

6700
6702

All Rights Reserved. KIMBER®, Colt®, Ruger®, SIG SAUER®, Para® USA, Remington®, Smith & Wesson® and Springfield Armory® are registered trademarks of KIMBER®, Colt®, Ruger®, SIG SAUER®, Para® USA, Remington®, Smith & Wesson® and Springfield Armory®. Streamlight has not sought endorsements of the fore mentioned Corporations.

STREAMLIGHT
SUB-COMPACT WEAPON-MOUNTED SERIES



STREAMLIGHT SUB-COMPACT LIGHTS

**FORGED FOR THE MOST
EXTREME CONDITIONS.**

TLR-3®

WHITE LIGHT ILLUMINATOR

Lightweight and powerful, this super-bright light is designed for sub-compact and compact weapons, yet it fits the broadest array of handguns – up to full size. Operates in temperatures from -40°F to +120°F. IPX7 rated waterproof to 1 meter for 30 minutes.

TLR-3

BATTERY: (1) 3V “CR2” lithium

SIZE: 2.71" x 1.18" x 1.51" (6.88 x 3.00 x 3.84 cm)

WEIGHT: 2.32 oz (65.8 g)

COLOR: Black

69220	Standard model includes rail locating keys for use with Picatinny or Glock® style rails. Lithium battery. Black.
69221	H&K USP Compact Model. Black.
69222	H&K USP Full-Size Model. Black.

LUMENS:	170
CANDELA:	3,300
DISTANCE:	115m
RUN TIME:	1h 30m

170 LUMENS



TLR-4®

WHITE LIGHT ILLUMINATOR // RED LASER

Designed for sub-compact and compact weapons, this white light illuminator features a red laser to guide your aim. Operates in temperatures from -20°F to +120°F. IPX4 rated water-resistant.

TLR-4

BATTERY: (1) 3V “CR2” lithium

SIZE: 2.73" x 1.20" x 1.99" (6.93 x 3.05 x 5.05 cm)

WEIGHT: 2.81 oz (79.7 g)

COLOR: Black

69240	Standard model includes rail locating keys for use with Picatinny or Glock® style rails. Lithium battery. Black.
69241	H&K USP Compact Model. Black.
69242	H&K USP Full-Size Model. Black.

LUMENS:	170
CANDELA:	3,300
DISTANCE:	115m
RUN TIME:	1h 30m

Laser only mode: 15 hours of run time

170 LUMENS



TLR-4® G

WHITE LIGHT ILLUMINATOR // GREEN LASER

Extremely compact weapon-mounted light specifically designed for compact/sub-compact weapons, yet still fits a broad range of handguns. Produces a concentrated beam with optimum peripheral illumination. It includes a long-range green laser to help guide your aim. The laser operates through an extended temperature range – from -20°F to +120°F. IPX4 rated water-resistant.

TLR-4 G

BATTERY: (1) 3V “CR2” lithium

SIZE: 2.73" x 1.20" x 1.99" (6.93 x 3.05 x 5.05 cm)

WEIGHT: 2.81 oz (79.7 g)

COLOR: Black

69245	Standard model includes rail locating keys for use with Picatinny or Glock® style rails. Lithium battery. Black.
69246	H&K USP Compact Model. Black.
69247	H&K USP Full-Size Model. Black.

LUMENS:	160
CANDELA:	3,200
DISTANCE:	113m
RUN TIME:	1h 45m LED Only
RUN TIME:	1h 15m LED + Laser

Laser only mode: 4 hours of run time

160 LUMENS





PROTAC® RAIL MOUNT 1

This 350 lumen light featuring a dedicated fixed-mount for MIL-STD 1913 rails. It uses either a remote switch with momentary/constant on operation or a standard push-button tail switch, and can run on either a lithium battery or an easy-to-find alkaline battery. TEN-TAP® programming provides operator custom options.

PROTAC RAIL MOUNT 1

BATTERY: (1) 3V “CR123A” lithium or (1) “AA” Alkaline
SIZE: 4.25" x 1.50" x 1.20" (10.8 x 3.81 x 3.04 cm)
WEIGHT: 4.3 OZ (121.9 g) w/CR123 // 4.5 OZ (127.57 g) w/Alkaline
COLOR: Black

88058 with (1) lithium & (1) “AA” Battery—Black

350 LUMENS



With **[(STROBE)]**
Double tap switch to activate.

MULTI-FUEL DESIGN:
 Runs on one “AA” alkaline or CR123A lithium battery — both included.

TEN-TAP® programmable switch allows user selection of one of three different programs:

- high/strobe (factory default)
- high only
- low/high

	CR123	HIGH	LOW
LUMENS:		350	40
CANDELA:		12,000	1,380
DISTANCE:		219m	19m
RUN TIME:		1h 45m	14h 30m

Strobe runs 2.75 hours

	ALKALINE	HIGH	LOW
LUMENS:		150	40
CANDELA:		4,950	1,380
DISTANCE:		141m	19m
RUN TIME:		1h 30m	8h

Strobe runs 2.75 hours

THE PROTAC RAIL MOUNT LIGHTS

SHATTER

THE DARK

WITHOUT BREAKING THE BANK.

PROTAC® RAIL MOUNT 2

This 625 lumen light featuring a dedicated fixed-mount for MIL-STD 1913 rails. Lightweight, this bright light can be used in close quarter combat or to identify medium range threats. Rugged, reliable and easy-to-use pressure switch comes with a button for on/off for momentary activation. TEN-TAP® programming provides operator custom options.

PROTAC RAIL MOUNT 2

BATTERY: (2) 3V "CR123A" lithium

SIZE: 5.00" x 1.50" x 1.20" (12.7 x 3.81 x 3.04 cm)

WEIGHT: 5.00 oz (141.7 g)

COLOR: Black

88059 with (2) lithium batteries—Black

TEN-TAP® programmable switch allows user selection of one of three different programs:

- high/strobe (factory default)
- high only
- low/high

With **[(STROBE)]**
Double tap switch to activate.

625 LUMENS



CR123	HIGH	LOW
LUMENS:	625	60
CANDELA:	22,000	2,000
DISTANCE:	297m	89m
RUN TIME:	2h	21h

Strobe runs 2.75 hours

PROTAC® RAIL MOUNT HL-X

The ProTac series expands its weapon-mounted lights with this 1,000 lumen light featuring a dedicated fixed-mount for MIL-STD 1913 rails. Lightweight, this bright light can be used in close quarter combat or to identify medium range threats. Rugged, reliable. Its easy-to-use pressure switch comes with a button for on/off and a pressure switch for momentary activation. TEN-TAP® programming provides operator custom options.

PROTAC RAIL MOUNT HL-X

BATTERY: (2) 3V "CR123A" lithium or

(1) 18650 Li-Ion 3.7v 2600mAh rechargeable

SIZE: 5.43" x 1.45" x 1.72" (13.8 x 3.68 x 4.37 cm)

WEIGHT W/2X CR123: 6.4 oz (181.4 g)

WEIGHT W/18650 LI-ION: 6.9 oz (195.6 g)

COLOR: Black

88066 with (2) lithium batteries—Black

TEN-TAP® programmable switch allows user selection of one of three different programs:

- high/strobe (factory default)
- high only
- low/high

With **[(STROBE)]**
Double tap switch to activate.

1,000 LUMENS



MULTI-FUEL DESIGN:

Runs on CR123 or 18650 batteries

WITH CR123	HIGH	LOW
LUMENS:	1,000	60
CANDELA:	27,600	1,600
DISTANCE:	332m	80m
RUN TIME:	1h 15m	20h

Strobe runs 2.5 hours

WITH 18650	HIGH	LOW
LUMENS:	1,000	60
CANDELA:	27,600	1,600
DISTANCE:	332m	80m
RUN TIME:	1h 30m	23h

Strobe runs 3.25 hours



TACTICAL
SERIES //

TACTICAL LIGHTING

FROM EVERY DAY CARRY TO SPECIALIZED HANDS-FREE LIGHTING. STREAMLIGHT IS TACTICAL.

It takes more than a Matte Black or Flat Dark Earth finish to call yourself tactical at Streamlight. We build a complete series of lights dedicated to providing you with the optimal performance for the task at hand. Choose from a full family of ProTac and PolyTac lights with high-lumen and long runtime options and of course the most versatile military light in the world... the Sidewinder.

PROTAC HL® 5-X USB



POLYTAC® X USB



PROTAC® 1L-1AA



SIDEWINDER COMPACT® II

18650 USB BATTERY WITH INTEGRATED PORT

The 18650 USB Lithium-Ion battery provides an alternate power source for newer Streamlight products that accept either standard CR123A lithium batteries or 18650 batteries. It features an integrated safety circuit that protects from over charging or overdischarging. The 18650 battery with integrated micro USB port charges in 5 hours. A wide variety of power sources can be used, such as a PC, power pack or 12VDC automotive power.

18650 BATTERY WITH INTEGRATED PORT

BATTERY CAPACITY: 3.7V, 2600mAh, rechargeable

BATTERY SIZE: 2.75" x .744" (.7 x 1.89cm)

BATTERY WEIGHT: 1.7 oz (48 g)

22101	18650 Battery with USB port - 1 pack
22102	18650 Battery with USB port - 2 pack

LED display for battery charge status.



CHARGING

CHARGED

USB Rechargeable 2600mAh 18650 Lithium Ion Battery – Charges in 5 hours. Featuring charge status indicator.

SEE PAGE 105 FOR OUR 18650 CHARGER KIT



X USB MULTI-FUEL FLEXIBILITY

A NEW WAY TO LOOK AT BATTERIES AND RECHARGEABILITY

THE FLEXIBILITY TO POWER YOUR LIGHT WITH...



OR



OUR TACTICAL LIGHTS JUST GOT MORE VERSATILE INTRODUCING USB MULTI-FUEL OPTIONS

PROTAC HL® 5-X USB PROTAC HL® 5-X

The ProTac HL 5-X is a 3,500 lumen tactical light that comes in 2 versions. The ProTac HL 5-X USB is a rechargeable system. It comes with our 18650 USB battery with integrated USB charging port. The ProTac HL 5-X comes with four CR123A batteries. Multi-battery versatility means the user can always use primary disposable cells to power the light if the rechargeable cell is out of power and a charging source is not available. The output from the LED results in one of the brightest tactical lights available. The “sure grip rubber sleeve” and included lanyard ensure you’ll never lose your grip.

PROTAC HL 5-X USB / PROTAC HL 5-X

BATTERY: (2) 18650 Li-Ion 3.7v 2600mAh rechargeable or (4) 3V “CR123A” lithium

SIZE: 9.53" x 2.35" x 1.24"
(23.65 x 5.97 x 3.15 cm)

WEIGHT W/18650: 1 lb 3.4 oz (550 g)

WEIGHT W/(4) CR123A: 1 lb 2.4 oz (522 g)

COLOR: Black

HL 5-X USB (18650)	HL 5-X (CR123A)
88080	88074 with batteries, wrist lanyard – Clam
88081	88075 with batteries, wrist lanyard – Box

ACCESSORIES

22082	USB “Y” cord - 22”
22070	USB cord - 40”
22081	USB cord - 22”
22100	18650 Battery Charge Cradle
22101	18650 Battery with USB port - 1 pack
22102	18650 Battery with USB port - 2 pack

MULTI-FUEL DESIGN:

Runs on (2) 18650 or (4) CR123A batteries

WITH 18650	HIGH	MEDIUM	LOW
LUMENS:	3,500	1,000	250
CANDELA:	51,000	14,100	3,620
DISTANCE:	452m	237m	120m
RUN TIME:	1h 15m	3h	11h 30m

Strobe runs 1.25 hours

WITH CR123A	HIGH	MEDIUM	LOW
LUMENS:	2,500	1,000	250
CANDELA:	37,000	14,100	3,620
DISTANCE:	385m	237m	120m
RUN TIME:	1h 30m	2h 30m	10h 30m

Strobe runs 1.5 hours



NEW

3,500 LUMENS (W/18650 BATTERIES)

HL SERIES

TEN-TAP® programmable switch allows user selection of one of three different programs:

- high/strobe/low (factory default)
- high only
- low/medium/high

HL® With **[(STROBE)]**
Double tap switch to activate.

X USB MULTI-FUEL FLEXIBILITY

Both the ProTac HL 5-X USB and the ProTac HL 5-X are multi-fuel and accept either 18650 USB batteries or CR123A batteries.



**INCLUDES (2) 18650 USB BATTERIES
AND USB “Y” CORD - ALLOWING YOU
TO CHARGE BOTH BATTERIES AT ONCE**

**PROTAC® HL-X USB
PROTAC® HL-X**

The ProTac HL-X is a 1,000 lumen tactical light that comes in 2 versions. The ProTac HL-X USB is a rechargeable system. It comes with our new 18650 USB battery with integrated USB charging port. The ProTac HL-X comes with 2 CR123A batteries. Multi-battery versatility means the user can always use primary disposable cells to power the light if the rechargeable cell is out of power and a charging source is not available. It features a tactical tail cap switch for momentary or constant on operation, three different user selectable programs and a pocket clip for convenience. IP68 rated; dust tight and waterproof to 2 meters.

PROTAC HL-X USB / PROTAC HL-X

BATTERY: (1) 18650 Li-Ion 3.7v 2600mAh rechargeable or (2) 3V "CR123A" lithium

SIZE: 5.43" x 1.44" x 1.0" (13.8 x 3.7 x 2.54 cm)

WEIGHT W/18650: 6.2 OZ (176 g)

WEIGHT W/(2) CR123A: 5.7 OZ (162 g)

COLOR: Black

HL-X USB (18650)	HL-X (CR123A)	
88084	88064	batteries, holster and wrist lanyard – Clam
88085	88065	batteries, holster and wrist lanyard – Box
ACCESSORIES		
22101	18650 Battery with USB port - 1 pack	
22102	18650 Battery with USB port - 2 pack	
22100	18650 Battery Charge Cradle	
22070	USB cord - 40"	
22081	USB cord - 22"	
88043	Nylon Holster	

1,000 LUMENS
HL SERIES



NEW

TEN-TAP® programmable switch allows user selection of one of three different programs:

- high/strobe/low (factory default)
- high only
- low/medium/high

HL® With **[(STROBE)]**
Double tap switch to activate.

MULTI-FUEL DESIGN:
Runs on (1) 18650 battery or (2) CR123A

WITH 18650	HIGH	MEDIUM	LOW
LUMENS:	1,000	400	65
CANDELA:	27,100	10,000	1,600
DISTANCE:	330m	200m	80m
RUN TIME:	1h 30m	3h 30m	23h

Strobe runs 3.25 hours

WITH CR123A	HIGH	MEDIUM	LOW
LUMENS:	1,000	400	65
CANDELA:	27,100	10,000	1,600
DISTANCE:	330m	200m	80m
RUN TIME:	1h 15m	3h	20h

Strobe runs 2.5 hours



**SEE PAGE 105 FOR OUR
18650 CHARGER KIT**

**PROTAC® 2L-X USB
PROTAC® 2L-X**

The ProTac 2L-X is a 500 lumen light that comes in 2 versions. The ProTac 2L-X USB is a rechargeable system. It comes with our new 18650 USB battery with integrated USB charging port. The ProTac 2L-X comes with 2 CR123A batteries. Multi-battery versatility means the user can always use primary disposable cells to power the light if the rechargeable cell is out of power and a charging source is not available. It features a tactical tail cap switch for momentary or constant on operation, three different user selectable programs and a pocket clip for convenience. IPX7 waterproof to 1 meter for 30 minutes; 1 meter impact resistance tested.

PROTAC 2L-X

BATTERY: (1) 18650 Li-Ion 3.7v 2600mAh rechargeable or (2) 3V "CR123A" lithium

SIZE: 5.14" x 1.06" x .94" (13.0 x 2.7 x 2.4 cm)

WEIGHT W/18650: 4.4 OZ (125 g)

WEIGHT W/(2) CR123A: 3.9 OZ (111 g)

COLOR: Black

2L-X USB (18650)	2L-X (CR123A)	
88082	88062	batteries, holster and wrist lanyard – Clam
88083	88063	batteries, holster and wrist lanyard – Box
ACCESSORIES		
22101	18650 Battery with USB port - 1 pack	
22102	18650 Battery with USB port - 2 pack	
22100	18650 Battery Charge Cradle	
22070	USB cord - 40"	
22081	USB cord - 22"	
88036	Nylon Holster	



NEW
500 LUMENS

With **[(STROBE)]**
Double tap switch to activate.

TEN-TAP® programmable switch allows user selection of one of three different programs:

- high/strobe/low (factory default)
- high only
- low/high

MULTI-FUEL DESIGN:
Runs on (1) 18650 battery or (2) CR123A

WITH 18650	HIGH	LOW
LUMENS:	500	40
CANDELA:	6,800	600
DISTANCE:	165m	49m
RUN TIME:	3h 15m	30h

Strobe runs 4.5 hours

WITH CR123A	HIGH	LOW
LUMENS:	500	40
CANDELA:	6,800	600
DISTANCE:	165m	49m
RUN TIME:	2h 45m	30h

Strobe runs 3.25 hours



**SEE PAGE 105 FOR OUR
18650 CHARGER KIT**

NEED HIGH LUMEN PERFORMANCE?

CHOOSE FROM THE PROTAC FAMILY.

THE 2,200 LUMEN PROTAC HL® 4



PROTAC HL® 4

With 2,200 lumens of blinding light, the ProTac HL®4 is a super bright member of the ProTac® family. It offers the latest in power LED technology and three different user selectable programs. The output from the LED results in a super bright tactical light. The “sure grip rubber sleeve” and included lanyard ensures you’ll never lose your grip. IPX7 waterproof to 1 meter for 30 minutes; 1 meter impact resistance tested.

PROTAC HL 4

BATTERY: (4) 3V “CR123A” lithium or (2) 18650 Li-Ion 3.7v 2600mAh rechargeables

SIZE: 8.63” x 2.35” x 1.24” (21.92 x 5.97 x 3.15 cm)

WEIGHT: 17 oz (482 g)

COLOR: Black

88060 with lithium batteries and wrist lanyard—Black

TEN-TAP® programmable switch allows user selection of one of three different programs:

- high/strobe/low (factory default)
- high only
- low/med/high

2,200 LUMENS HL SERIES



HL® With **[(STROBE)]**
Double tap switch to activate.

MULTI-FUEL DESIGN:

Runs on (4) CR123 or (2) 18650 batteries

WITH CR123	HIGH	MEDIUM	LOW
LUMENS:	2,200	600	60
CANDELA:	30,000	8,300	800
DISTANCE:	346m	182m	56m
RUN TIME:	1h 30m	4h	40h

Strobe runs 2.5 hours

WITH 18650	HIGH	MEDIUM	LOW
LUMENS:	2,200	600	60
CANDELA:	30,000	8,300	800
DISTANCE:	346m	182m	56m
RUN TIME:	1h 45m	4h 15m	43h

Strobe runs 3.5 hours



PROTAC® HPL USB

The Pro Tac HPL® USB is a versatile tactical light designed for down range applications, that can charge from multiple sources and use three battery types; Streamlight 18650 rechargeable lithium ion battery, two CR123A batteries, or lithium ion batteries. This light will charge from a laptop or most USB wall chargers. Multi-battery versatility means you can always use primary disposable cells to power the light when a charging source is not available. It features a tail cap switch for momentary or constant on operation, three different user selectable programs and a pocket clip for convenience. IPX4 rated for water resistance.

PROTAC HPL USB

BATTERY: Lithium-ion, Lithium-ion 18650 or (2) 3V "CR123A" lithium

SIZE: 7.08" x 1.72" x 1.07" (18 x 4.38 x 2.7 cm)

WEIGHT: 9.24 OZ (262 g) with Li-On battery

COLOR: Black

	HIGH	MEDIUM	LOW
LUMENS:	1,000	400	65
CANDELA:	35,000	14,100	2,250
DISTANCE:	374m	237m	95m
RUN TIME:	1h 30m	3h 30m	24h

Strobe runs 3 hours

1,000 LUMENS HPL SERIES

NEW



With **[(STROBE)]**
Double tap switch to activate.

TEN-TAP® programmable switch allows user selection of one of three different programs:

- high/strobe/low (factory default)
- high only
- low/medium/high

Recharge by plugging into USB port or optional AC wall adapter

88076	with USB Cord and holster—Black—Clam
88077	with USB Cord and holster—Black—Box
88078	with USB 120V/DC and holster—Black—Clam

ACCESSORIES

22070	40" USB cord
88048	Nylon Holster

PROTAC HL® USB

The ProTac HL USB is incredibly bright and features new multiple power source capability; Streamlight 18650 rechargeable lithium ion battery, two CR123A batteries, or lithium ion batteries. It recharges by connecting to a USB port, so it's easy to charge on the go. The anti-rattle battery compartment keeps batteries securely and quietly in place and doesn't need a battery carrier. TEN-TAP® programming lets you choose the selection of operating modes (high/strobe/low, high only or low/medium/high). IPX4 rated for water resistance.

PROTAC HL USB

BATTERY: Lithium-ion, Lithium-ion 18650 or (2) 3V "CR123A" lithium

SIZE: 6.50" x 1.23" x 1.07" (16.5 x 3.1 x 2.7 cm)

WEIGHT: 7.2 OZ (204 g) with Li-On battery

COLOR: Black

	HIGH	MEDIUM	LOW
LUMENS:	1,000	380	65
CANDELA:	12,000	4,420	700
DISTANCE:	219m	133m	53m
RUN TIME:	1h 30m	3h 30m	23h

Strobe runs 1.5 hours

1,000 LUMENS HL SERIES

Recharge by plugging into USB port or optional AC wall adapter



With **[(STROBE)]**
Double tap switch to activate.

TEN-TAP® programmable switch allows user selection of one of three different programs:

- high/strobe/low (factory default)
- high only
- low/medium/high

88052	with USB Cord and holster—Black
88054	with USB 120V/DC and holster—Black

PROTAC SERIES

THE PERFECT BLEND OF PERFORMANCE + DURABILITY

PROTAC HL®3

Put 1,100 lumens in the palm of your hands with a wide beam pattern that illuminates an entire area. TEN-TAP® programming lets you choose the order of operating modes. IPX7-rated waterproof to 1 meter/30 minutes. 1 meter impact-resistance tested. Includes rubber sleeve.

PROTAC HL 3

BATTERY: (3) 3V "CR123A" lithium
SIZE: 7.1" x 1.73" x 1.0" (18.03 x 4.39 x 2.54 cm)
WEIGHT: 9.3 oz (263 g)
COLOR: Black

	HIGH	LOW
LUMENS:	1,100	35
CANDELA:	36,000	1,200
DISTANCE:	379m	69m
RUN TIME:	2h	43h

Strobe runs 2 hours

1,100 LUMENS HL SERIES



HL® With [(STROBE)]
 Double tap switch to activate.

TEN-TAP® programmable switch allows user selection of one of three different programs:

- high/strobe/low (factory default)
- high only
- low/high

88047 with lithium batteries and holster— Black

ACCESSORIES

88048 Nylon Holster

PROTAC HL®

One of the brightest tactical personal carry lights of its size, with a far-reaching beam. TEN-TAP® programming lets you choose the order of operating modes. IPX7-rated waterproof to 1 meter/30 minutes. 1 meter impact-resistance tested.

PROTAC HL

BATTERY: (2) 3V "CR123A" lithium
SIZE: 5.4" x 1.375" x 1.0" (13.72 x 3.49 x 2.54 cm)
WEIGHT: 5.6 oz (158 g)
COLOR: Black

	HIGH	LOW
LUMENS:	750	35
CANDELA:	18,300	900
DISTANCE:	270m	60m
RUN TIME:	1h 15m	18h

Strobe runs 2.5 hours

750 LUMENS HL SERIES



HL® With [(STROBE)]
 Double tap switch to activate.

TEN-TAP® programmable switch allows user selection of one of three different programs:

- high/strobe/low (factory default)
- high only
- low/high

88040 with lithium batteries and holster— Black

ACCESSORIES

88043 Nylon Holster



PROTAC® 1L-1AA

The Protac® 1L-1AA is a perfect everyday carry light. This multi-fuel, ultra-compact flashlight accepts a single lithium or alkaline battery, providing you with ultimate flexibility in the field. Packaged with a removable pocket clip and holster. IPX7 waterproof to 1 meter for 30 minutes; 2 meter impact resistance tested.

PROTAC 1L-1AA

BATTERY: (1) 3V "CR123A" lithium or 1"AA" alkaline/lithium

SIZE: 4.25" x .95" x .850" (10.8 x 2.41 x 2.16 cm)

WEIGHT W/CR123: 2.5 oz (71 g)

WEIGHT: 2.8 oz (79 g) Alkaline // 2.4 oz (68 g) Lithium

COLOR: Black

PROTAC® 1L-1AA

88061 with (1) alkaline & lithium batteries and holster – Black

88073 with (1) alkaline & lithium batteries and holster – Coyote

ACCESSORIES

88037 Nylon Holster



MULTI-FUEL DESIGN:

Runs on (1) CR123 or (1) "AA" battery

WITH CR123	HIGH	LOW
LUMENS:	350	40
CANDELA:	6,400	720
DISTANCE:	160m	53m
RUN TIME:	1h 30m	14h

Strobe runs 3 hours

WITH "AA" ALK.	HIGH	LOW
LUMENS:	150	40
CANDELA:	2,750	720
DISTANCE:	105m	53m
RUN TIME:	1h 20m	7h 30m

Strobe runs 3.5 hours

WITH "AA" LITHIUM	HIGH	LOW
LUMENS:	150	40
CANDELA:	2,750	720
DISTANCE:	105m	53m
RUN TIME:	4h 15m	14h

Strobe runs 8 hours

TEN-TAP® programmable switch allows user selection of one of three different programs:

- high/strobe/low (factory default)
- high only
- low/high



THE PROTAC SERIES... **SMALLEST,** **LIGHTEST HAND-HELD TACTICALS.**

PROTAC® 1L

Ultra-compact and lightweight, yet powerful, bright, with long run times and lots of important features. TEN-TAP® programming for user selection of mode programs (high, low, strobe). IPX7 waterproof to 1 meter for 30 minutes. 2 meter impact resistance tested. Maximum light output throughout battery life.

PROTAC 1L

BATTERY: (1) 3V "CR123A" lithium

SIZE: 3.43" x .9" x .77" (8.71 x 2.29 x 1.96 cm)

WEIGHT: 2.0 oz (57 g)

COLOR: Black

PROTAC® 1L

88030 with (1) lithium batteries and holster – Black

ACCESSORIES

88035 Nylon Holster

	HIGH	LOW
LUMENS:	275	22
CANDELA:	5,100	420
DISTANCE:	143m	41m
RUN TIME:	2h	24h

Strobe runs 3.5 hours



With **[(STROBE)]**
Double tap switch to activate.

TEN-TAP® programmable switch allows user selection of one of three different programs:

- high/strobe/low (factory default)
- high only
- low/high

PROTAC® 2L

The ProTac® 2L is compact and lightweight, yet powerful, bright, with long run times and lots of important features. TEN-TAP® programming for user selection of mode programs. IPX7 waterproof to 1 meter for 30 minutes. 2 meter impact resistance tested. Maximum light output throughout battery life.

PROTAC 2L

BATTERY: (2) 3V "CR123A" lithium

SIZE: 4.77" x .9" x .77" (12.12 x 2.29 x 1.96 cm)

WEIGHT: 2.8 oz (79 g)

COLOR: Black

PROTAC® 2L

88031 with (2) lithium batteries and holster – Black

ACCESSORIES

88036 Nylon Holster

	HIGH	LOW
LUMENS:	350	30
CANDELA:	6,300	600
DISTANCE:	159m	49m
RUN TIME:	3h 15m	35h

Strobe runs 6 hours



With **[(STROBE)]**
Double tap switch to activate.

TEN-TAP® programmable switch allows user selection of one of three different programs:

- high/strobe/low (factory default)
- high only
- low/high

THE PROTAC SERIES... **A COMPLETE** **FOR ALL TYPES OF USES, FROM**

PROTAC® 2AA

Small enough to carry in a pocket, lightweight, yet extremely bright. TEN-TAP® programming for user selection of mode programs. IPX7 waterproof to 1 meter for 30 minutes. 2 meter impact resistance tested. Maximum light output throughout battery life.

PROTAC 2AA

BATTERY: [2] "AA" alkaline
SIZE: 6.14" x .9" x .65"
(15.60 x 2.29 x 1.65 cm)
WEIGHT: 3.4 OZ (96 g)
COLOR: Black or Coyote

PROTAC® 2AA

88033 with [2] alkaline batteries and holster – Black
88072 with [2] alkaline batteries and holster – Coyote

ACCESSORIES

88038 Nylon Holster

	HIGH	LOW
LUMENS:	250	18
CANDELA:	4,250	400
DISTANCE:	130m	40m
RUN TIME:	2h	43h

Strobe runs 4 hours



With **[(STROBE)]**
Double tap switch to activate.

TEN-TAP® programmable switch allows user selection of one of three different programs:

- high/strobe/low (factory default)
- high only
- low/high

PROTAC® 1AAA

Compact and powerful, this ProTac® series flashlight offers three different user selectable programs and the latest in power LED technology. The combination of small size and output from the LED result in one of the brightest tactical personal carry lights for its size. Packaged with a removable pocket clip and holster. IPX7 waterproof to 1 meter for 30 minutes. 2 meter impact resistance tested.

PROTAC 1AAA

BATTERY: [1] "AAA" alkaline or lithium
SIZE: 3.94" x .71" x .57" (10.0 x 1.80 x 1.44 cm)
WEIGHT: 1.3 OZ (37 g)
COLOR: Black

PROTAC® 1AAA

88049 with [1] alkaline battery and holster – Black

ACCESSORIES

72024 Lanyard

MULTI-FUEL DESIGN:

Runs on [1] CR123 or [1] "AA" battery

LITHIUM	HIGH	LOW	ALKALINE	HIGH	LOW
LUMENS:	115	8	LUMENS:	115	8
CANDELA:	890	65	CANDELA:	890	65
DISTANCE:	60m	16m	DISTANCE:	60m	16m
RUN TIME:	2h 15m	23h	RUN TIME:	1h 45m	17h

Strobe runs 3.75 hours

Strobe runs 1.5 hours



With **[(STROBE)]**
Double tap switch to activate.

TEN-TAP® programmable switch allows user selection of one of three different programs:

- high/strobe/low (factory default)
- high only
- low/high

FAMILY OF LIGHTS

EVERY DAY CARRY TO MEDICAL USE.

PROTAC® 2AAA

Lightweight personal flashlight with three modes (high, low, and strobe), a removable pocket clip and a 13-hr. run time on low. IPX7 waterproof to 1 meter for 30 minutes. Maximum light output throughout battery life.

PROTAC 2AAA

BATTERY: (2) "AAA" alkaline

SIZE: 5.62" x .72" x .50" (14.27 x 1.83 x 1.27 cm)

WEIGHT: 2.0 OZ (57 g)

COLOR: Black

PROTAC® 2AAA

88039 with (2) alkaline batteries — Black

ACCESSORIES

88045 Nylon Holster

	HIGH	LOW
LUMENS:	130	20
CANDELA:	1,230	230
DISTANCE:	70m	30m
RUN TIME:	1h 45m	13h

Strobe runs 3.5 hours



With **[(STROBE)]**
Double tap switch to activate.

TEN-TAP® programmable switch allows user selection of one of three different programs:

- high/strobe/low (factory default)
- high only
- low/high

PROTAC® EMS

Provides optimal non-glare light for pupil and wound examination. Long run time. Tempered glass lens for maximum beam clarity. IPX7-rated waterproof to 1 meter for 30 minutes. Maximum light output throughout battery life. Removable pocket clip.

PROTAC EMS

BATTERY: (1) "AA" alkaline or lithium

SIZE: 3.97" x .9" x .65" (10.08 x 2.29 x 1.65 cm)

WEIGHT: 2.3 OZ (65 g)

COLOR: EMS Blue

88034 with (1) alkaline battery and holster — EMS Blue

ACCESSORIES

88037 Nylon Holster

	LOW	MED	HIGH
LUMENS:	3.6	10	50
CANDELA:	120	340	1,450
DISTANCE:	20m	36m	76m
RUN TIME:	36h	14h	1h 30m



PROTAC VERSATILITY WHEREVER YOU NEED LIGHT AND

PROTAC HL® HEADLAMP

The perfect light for when your task requires both hands and a bright light with a wide, long-range beam. 90° tilting head reduces neck fatigue. TEN-TAP® programming lets you choose the order of operating modes. IPX4 rated for water resistance. 1 meter impact-resistance tested. Maximum light output throughout battery life.

PROTAC HL HEADLAMP

BATTERY: [2] 3V "CR123A" lithium
SIZE: 3.66" x 1.2" x 2.6" (9.30 x 3.05 x 6.60 cm)
WEIGHT: 6.6 oz (187 g)
COLOR: Black

61304 with lithium batteries—rubber and elastic straps—Black

	HIGH	MEDIUM	LOW
LUMENS:	635	105	20
CANDELA:	8,500	1,450	280
DISTANCE:	184m	76m	33m
RUN TIME:	1h 45m	8h	36h

635 LUMENS

HL SERIES

HL®



TEN-TAP® programmable switch allows user selection of one of three different programs:

- high/medium/low (factory default)
- high only
- low/medium/high

PROTAC HL® USB HEADLAMP

All the great features of the ProTac HL® headlamp with 1,000 lumens, USB rechargeability and Streamlight 18650 USB battery compatibility. TEN-TAP® programming lets you choose the order of operating modes. Includes diffuser lens for spot/flood functionality as well as interchangeable red and green lenses. IPX4 rated for water resistance. 1 meter impact-resistance tested. Maximum light output throughout battery life. Includes red and green lenses. The Lithium Ion rechargeable battery is the only rechargeable battery that can be recharged while in the headlamp.

PROTAC HL USB HEADLAMP

BATTERY: Uses rechargeable lithium ion battery (included); also accepts a Streamlight 18650 lithium ion battery
SIZE: 4.03" x 1.20" x 3.12" (10.23 x 3.05 x 7.92 cm)
WEIGHT: 8.1 oz (230 g)
COLOR: Black

61305 ProTac HL USB Headlamp—Black

61306 ProTac HL USB Headlamp 120V AC—Black

	HIGH	MEDIUM	LOW
LUMENS:	1,000	400	65
CANDELA:	13,500	5,400	900
DISTANCE:	232m	147m	60m
RUN TIME:	1h 45m	3h 30m	24h

1,000 LUMENS

HL SERIES

HL®



MULTI-FUEL DESIGN:
Runs on a Strion rechargeable battery (included) or (1) 18650 battery

TEN-TAP® programmable switch allows user selection of one of three different programs:

- high/medium/low (factory default)
- high only
- low/medium/high



HOWEVER YOU POWER IT.

18650 CHARGER KIT

18650 Lithium-Ion batteries provide an alternate power source for newer Streamlight products that accept either standard CR123A lithium batteries or 18650 batteries. The two bay 18650 battery charger can recharge one 18650 battery in as little as 3.5 hours, or two batteries in as little as 6.5 hours. The charger features dual input power sources, accepting either 5V USB power or traditional AC or 12V DC power sources. Dual input power sources provide a wide variety of battery charging options when a wall outlet is not available, such as a PC, power pack or 12V DC automotive power. Models available with charger, two 18650 batteries and either a 120V AC/micro-USB adapter or custom micro-USB cord.

22010	18650 Charger Kit - USB (includes [2] 18650 batteries)
22011	18650 Charger Kit - 120V AC (includes [2] 18650 batteries)

18650 LI-ION CHARGER KIT

BATTERY: 3.7V, 2600mAh, rechargeable
CHARGER SIZE: 4.5" x 2.0" x 1.45" (11.4 x 5.1 x 3.7cm)
CHARGER WEIGHT: 2.4 OZ (68 g)
BATTERY WEIGHT: 1.7 OZ (48 g)

Two bay design with single bay priority speeds charging when used with single battery products.

Individual bay LED display for battery charge status.



Charger temperature safety circuit prevents damage to batteries while charging.

EPU-5200™ PORTABLE USB CHARGER

We've made it easier than ever to keep your USB flashlights and mobile devices powered up and ready. You can clip the electronic power unit to a vest and take it anywhere. It's lightweight, yet rugged and durable to stand up to almost anything. And it's also a flashlight! IPX4 water-resistant with cover installed.

EPU-5200

BATTERY: Lithium ion cell pack
SIZE: 4.45" x 1.83" x 1.25" (11.3 x 4.7 x 3.2 cm)
WEIGHT: 5.4 OZ (153 g)
COLOR: Black

22600	with USB cord— Black
-------	----------------------

Take the power with you! Charge your light wherever you need to. (Light not included).



Charges most USB products with micro-USB input.

- 4+ full charges for Streamlight Stylus Pro® USB, Clipmate® USB and Double Clutch™ USB
- 2 full charges for Streamlight® ProTac HL® USB
- 1+ full charges for most smartphones and tablets



POLYTAC ACCESSORIES

									
	Rubber Helmet Strap	Holster	Red Flip Lens	Green Flip Lens	Blue Flip Lens	Infrared Lens	Helmet Mount	18650 Battery Kit	CR123A Batteries
PolyTac	99075	85909	85115	85117	85116	74039	68085	—	2 Pk. 85175 6 Pk. 85180 12 Pk. 85177 400 Pk. 85179
PolyTac HP	99075	88051	—	—	—	—	68085	—	
PolyTac X	99075	85905	85115	85117	85116	74039	—	22010 - USB 22011 - 120V	
PolyTac X USB	99075	85905	85115	85117	85116	74039	—	22010 - USB 22011 - 120V	

THE POLYTAC LIGHTS ARE SUPER-BRIGHT AND WITHSTAND CONSTANT PUNISHMENT.

POLYTAC®

Rugged housing, superior brightness and extended run times make the PolyTac ideal for the broadest range of lighting applications at the best value. Superior grip texture for a comfortable/slip-resistant feel. TEN-TAP® programming lets you choose the order of operating modes. IPX7 rated waterproof to 1 meter/30 minutes. Maximum light output throughout battery life.

POLYTAC

BATTERY: (2) 3V "CR123A" lithium
SIZE: 5.34" x 1.25" x 1"
 (13.56 x 3.45 x 2.54 cm)
WEIGHT: 4.2 OZ (121 g)
COLOR: Black, Coyote or Yellow

NFPA

Meets requirements of
 NFPA 1971-8.6 (2013)



With **[(STROBE)]**
 Double tap switch to activate.

POLYTAC® HP

Super-bright with a long-range beam – ideal for lighting the way to the end of a dark alley, down a wooded path, inspecting utility lines from the ground, or conducting search and rescue missions. Virtually indestructible housing. Features a superior grip texture for a comfortable/slip-resistant feel. TEN-TAP® programming lets you choose the order of operating modes. IPX7 rated waterproof to 1 meter/30 minutes. Maximum light output throughout battery life.

POLYTAC HP

BATTERY: (2) 3V "CR123A" lithium
SIZE: 5.90" x 1.68" x 1"
 (14.98 x 4.26 x 2.54 cm)
WEIGHT: 5.2 OZ (148 g)
COLOR: Black, Coyote or Yellow



With **[(STROBE)]**
 Double tap switch to activate.

TRADITION SERIES

	HIGH	MEDIUM	LOW
LUMENS:	600	260	35
CANDELA:	11,500	4,900	675
DISTANCE:	214m	140m	52m
RUN TIME:	2h 45m	5h 30m	34h

Strobe runs 5h 30m



Helmet Lighting Kit

88850	with lithium batteries – Black
88851	with lithium batteries – Coyote
88853	with lithium batteries – Yellow
88854	Helmet Kit – Yellow PolyTac, rubber strap & helmet mount

HP SERIES

	HIGH	MEDIUM	LOW
LUMENS:	600	260	35
CANDELA:	22,000	9,500	1,300
DISTANCE:	297m	195m	72m
RUN TIME:	2h 45m	5h 30m	34h

Strobe runs 5h 30m

88860	with lithium batteries – Black
88861	with lithium batteries – Coyote
88863	with lithium batteries – Yellow

THE POLYTAC FAMILY JUST GOT MORE VERSATILE INTRODUCING USB MULTI-FUEL OPTIONS

POLYTAC® X USB POLYTAC® X

The PolyTac X is a 600 lumen tactical light that comes in 2 versions. The PolyTac X USB is a rechargeable system. It comes with our new 18650 USB battery with integrated USB charging port. The PolyTac X comes with 2 CR123A batteries. Multi-battery versatility means the user can always use primary disposable cells to power the light if the rechargeable cell is out of power and a charging source is not available. The PolyTac X is a bright and compact personal polymer light. Superior grip texture for a comfortable/slip-resistant feel. TEN-TAP® programming lets you choose the order of operating modes. IPX7 rated waterproof to 1 meter/30 minutes. Maximum light output throughout battery life.

POLYTAC X USB / POLYTAC X

BATTERY: (1) 18650 Li-Ion 3.7v 2600mAh rechargeable or (2) 3V "CR123A" lithium

SIZE: 5.46" x 1.25" x 1.00"
(13.87 x 3.43 x 2.54 cm)

WEIGHT W/18650: 4.9 oz (139 g)

WEIGHT W/(2) CR123A: 4.4 oz (125 g)

COLOR: Black, Yellow or Coyote

POLYTAC X USB [18650]	POLYTAC X [CR123A]	
88610	88600	with batteries—Black—Clam
88611	88601	with batteries—Yellow—Clam
88612	88602	with batteries—Coyote—Clam
88613	88603	with batteries—Black—Box
88614	88604	with batteries—Yellow—Box
88615	88605	with batteries—Coyote—Box

ACCESSORIES

22070	USB cord - 40"
22081	USB cord - 22"
22101	18650 Battery with USB port - 1 pack
22102	18650 Battery with USB port - 2 pack
85905	Nylon Holster
85115	Flip Lens - Red
85116	Flip Lens - Blue
85117	Flip Lens - Green
74039	Flip Lens - IR
99075	Rubber Helmet Strap
68089	Poly Mount Kit
75902	Safety Wand - Blue
75903	Safety Wand - Red
75904	Safety Wand - Yellow
75908	Safety Wand - White
75913	Safety Wand - Glow in the Dark

MULTI-FUEL DESIGN:

Runs on (1) 18650 battery or (2) CR123A

WITH 18650	HIGH	MEDIUM	LOW	WITH CR123A	HIGH	MEDIUM	LOW
LUMENS:	600	260	35	LUMENS:	600	260	35
CANDELA:	11,485	4,930	675	CANDELA:	11,485	4,930	675
DISTANCE:	205m	135m	50m	DISTANCE:	205m	135m	50m
RUN TIME:	3h 30m	5h 45m	36h	RUN TIME:	2h 45m	5h 30m	34h

Strobe runs 8 hours

Strobe runs 5.5 hours



NEW
600 LUMENS

With **[(STROBE)]**

Double tap switch to activate.

TEN-TAP® programmable switch allows user selection of one of three different programs:

- high/strobe/low (factory default)
- high only
- low/medium/high

NFPA Meets requirements of NFPA 1971-8.6 (2013); 500° heat resistance test



X USB MULTI-FUEL FLEXIBILITY

X USB Version

Includes 18650 USB Battery and USB Cord

Both the PolyTac X USB and the PolyTac X are multi-fuel and accept either the Streamlight 18650 USB battery or CR123A batteries.

WHEN IT COMES TO HAND-HELD TACTICALS...
THE BRIGHTEST
LIGHT CONTROLS
THE FIGHT.



SUPER TAC® X

Super bright with high, low and strobe modes. Far-reaching beam is ideal for long-range target acquisition. Unbreakable, scratch-resistant lens. IPX4 rated for water resistance. 2 meter impact-resistance tested. Openings O-ring sealed. Regulated intensity throughout battery life.

SUPER TAC X

BATTERY: (2) 3V "CR123A" lithium

SIZE: 6.62" x 2.2" x .9"
(16.81 x 5.59 x 2.29 cm)

WEIGHT: 7.1 OZ (201 g)

COLOR: Black

88708	with holster and lithium batteries. Boxed. Black.
88709	with lithium batteries. Clam packaged. Black.
88710	Super Tac Kit: Vert. grip with mount. Boxed. Black.

	HIGH	LOW
LUMENS:	200	10
CANDELA:	40,000	2,000
DISTANCE:	400m	89m
RUN TIME:	2h 30m	50h

Strobe runs 6 hours



Suitable for weapon-mount.

With **[(STROBE)]**
Double tap switch to activate.

Super Tac Kit. Includes vertical grip with rail and low profile mount.

TL-2® X

Pierces the darkness and shines for hours. Produces a smooth beam with optimum peripheral illumination to aid in navigation. High and low modes plus strobe. Includes belt/pocket clip. IPX4 -rated for water-resistance. 3 meter impact-resistance tested. Maximum light output throughout battery life.

TL-2 X

BATTERY: (2) 3V "CR123A" lithium

SIZE: 5.25" x 1.25" x .9"
(13.33 x 3.18 x 2.29 cm)

WEIGHT: 4.7 OZ (133 g)

COLOR: Black

88119	with lithium batteries. Black.
-------	--------------------------------

	HIGH	LOW
LUMENS:	200	10
CANDELA:	11,000	550
DISTANCE:	210m	47m
RUN TIME:	2h 30m	50h

Strobe runs 6 hours

With **[(STROBE)]**
Double tap switch to activate.



Suitable for weapon-mount.



	Remote Switch Retaining Clips	12 Ga. Mag Tube	Rail Mount	Amb. Vert Grip w/Rail	AR15/M16 Adapter	Low Profile Mount	Remote Switch w/Coil Cord*	Remote Switch w/8" Cord*
Super Tac X	88178	69903	69100	69114	69902	88118	88186	88185
TL-2 X	88178	69903	69100	69114	69902	88118	88186	88185
NightFighter X	—	—	—	—	—	—	*Fits TangoDown Rail Covers (includes two screws, tie wrap, double stick tape and retaining clips)	
Scorpion X	—	—	—	—	—	—		

SCORPION® HL

The only tactical light with a rubberized grip and tail switch is a water-resistant, high lumen flashlight! It has 725 lumens of blinding light, and TEN-TAP® programming.

SCORPION HL

BATTERY: (2) 3V "CR123A" lithium

SIZE: 5.46" x 1.375" x .96"
(13.97 x 3.49 x 2.44 cm)

WEIGHT: 4.8 oz (136 g)

COLOR: Black

85400 with lithium batteries. Black.

HL SERIES

	HIGH	LOW
LUMENS:	725	35
CANDELA:	18,500	950
RUN TIME:	1h 15m	18h

Strobe runs 2h 30m

TEN-TAP® programmable switch allows user selection of one of three different programs:

- high/strobe/low (factory default)
- high only
- low/high

HL® With **[(STROBE)]**
Double tap switch to activate.



SCORPION® X

Full-featured tactical light with high, low and strobe modes and a rubberized housing for secure grip. IPX4 rated for water-resistance. Unbreakable, scratch-resistant lens. 3 meter impact-resistance tested. Maximum light output throughout battery life.

SCORPION X

BATTERY: (2) 3V "CR123A" lithium

SIZE: 5.6" x 1.25" x .94"
(14.22 x 3.18 x 2.39 cm)

WEIGHT: 5.3 oz (142 g)

COLOR: Black

85011 with lithium batteries. Black.

	HIGH	LOW
LUMENS:	200	10
CANDELA:	11,000	550
DISTANCE:	210m	47m
RUN TIME:	2h 30m	50h

Strobe runs 6 hours

With **[(STROBE)]**
Double tap switch to activate.



NIGHTFIGHTER® X

The brightest light in the ultra-light Nightfighter series. Unique adjustable ring for one-handed operation. Features high, low and strobe modes. IPX4 rated for water-resistance. 3 meter impact-resistance tested. Maximum light output throughout battery life.

NIGHTFIGHTER X

BATTERY: (2) 3V "CR123A" lithium

SIZE: 5.4" x 1.25" x .88"
(13.72 x 3.18 x 2.24 cm)

WEIGHT: 5.2 oz (147 g)

COLOR: Black

88008 with lithium batteries. Black.

	HIGH	LOW
LUMENS:	200	10
CANDELA:	11,000	550
DISTANCE:	210m	47m
RUN TIME:	2h 30m	50h

Strobe runs 6 hours

With **[(STROBE)]**
Double tap switch to activate.



The fully adjustable ring – unique to the NightFighter X – adjusts to any hand size, providing a sure grip for one-handed operation.



TACTICAL ACCESSORIES

	Nylon Holster	Tactical Holster	Red Flip Lens	Green Flip Lens	Blue Flip Lens	IR Flip Lens	CR123A Batteries
Super Tac X	75910	88051	–	–	–	–	2 Pk. 85175 6 Pk. 85180
TL-2 X	–	–	85115	85117	85116	74039	12 Pk. 85177
NightFighter X	–	–	85115	85117	85116	74039	400 Pk. 85179
Scorpion X	85905	–	85115	85117	85116	74039	



SIDEWINDER®

Meets a wide variety of hands-free illumination requirements with various color LEDs at different outputs. 185° tilting head and belt/web clip for multiple positioning/aiming of light. Designed for easy selection of light modes when in the field and when wearing gloves. IPX7 rated waterproof to 1 meter for 30 minutes. 3 meter impact-resistance tested. O-ring and gasket-sealed for waterproof operation. Meets MIL-STD-810F, METHOD 512.4.

SIDEWINDER

BATTERY: (2) "AA" alkaline or (2) "AA" lithium for extended operation in extreme temperatures (-40° F to +150°F)

SIZE: 2.34" x 1.08" x 4.65" (5.94 x 2.74 x 11.81 cm)

LITHIUM WEIGHT: 4.38 oz (124 g)

ALKALINE WEIGHT: 5.02 oz (142 g)

COLOR: Coyote

Military Model (White, Red, Blue, IR LEDs)

14000	w/alkaline — Clam packaged. Coyote.
14032	w/alkaline — Boxed. Coyote.
14027	w/alkaline — with Helmet Mount. Clam packaged. Coyote.
14031	w/alkaline — with E-mount. Clam packaged. Coyote.

Aviation Model (White, Green, Blue, IR LEDs)

14008	w/alkaline — Clam packaged. Coyote.
14024	w/alkaline — with MOLLE retainer. Boxed. Coyote.

SIDEWINDER® RESCUE

PM AIR WARRIOR APPROVED

A lightweight hands-free lighting tool with four different color LEDs, each with varying intensities for a wide variety of tasks. It features a flashing beacon that coupled with the "Slide-in-Place" diffuser, projects omni-directional light to signal for help. The integrated diffuser allows you to go from tight, focused beam to wide, soft beam. Accepts either two "AA" alkaline batteries or two "AA" lithium batteries for maximum versatility in the field. IPX7 waterproof to 1 meter for 30 minutes.

SIDEWINDER RESCUE

BATTERY: (2) "AA" alkaline or (2) "AA" lithium for extended operation in extreme temperatures (-40° F to +150°F)

SIZE: 2.34" x 1.08" x 4.65" (5.94 x 2.74 x 11.81 cm)

LITHIUM WEIGHT: 4.38 oz (124 g)

ALKALINE WEIGHT: 5.02 oz (142 g)

COLOR: Coyote

Rescue Model (White, Green, Blue, IR LEDs)

14065	Kit Includes MOLLE retainer, paracord and alkaline batteries. Boxed
14069	Kit Includes MOLLE retainer, paracord and alkaline batteries. Clam
14066	w/alkaline — Light only. Boxed
14067	w/alkaline — Light only. Clam
14068	w/alkaline — Includes E-Mount. Boxed



WHITE LED	HIGH
LUMENS:	55
CANDELA:	1,175
DISTANCE:	69m
RUN TIME:	5h 30m

SIDEWINDER® LIGHT OUTPUT & BATTERY RUN TIME						
LED	Light Output	Low 5% Output	Medium 1 25% Output	Medium 2 60% Output	High 100% Output	Strobe 100% Output
White	55 Lumens	100 Hrs+	45 Hrs	11 Hrs	5.5 Hrs	10 Hrs
IR	25mW/sr [min] radiant intensity	200 Hrs+	140 Hrs	60 Hrs	24 Hrs	40 Hrs
Red	1 Lumens	200 Hrs+	140 Hrs	60 Hrs	24 Hrs	40 Hrs
Blue	1.8 Lumens	150 Hrs+	100 Hrs	35 Hrs	16 Hrs	30 Hrs
Green	4.5 Lumens	150 Hrs+	100 Hrs	35 Hrs	16 Hrs	30 Hrs

All run time to 10% of initial output level. Illumination output electronically regulated.



Rescue Model

- Blue LED
- IR LED
- Green LED

"Slide-in-Place" diffuser can be used with any LED color for omni-directional light

Aluminum plate provides flat surface to adhere Velcro® for attaching to helmet

Cord attachment for para-cord lanyard, which provides extra security from loss of light and allows it to be worn around the neck

Securely attaches to MOLLE or other straps using MOLLE retainer

SIDEWINDER... THE MOST VERSATILE MILITARY LIGHT IN THE WORLD.

SIDEWINDER ACCESSORIES

	Sidewinder	Sidewinder Compact II
Helmet Mount - Coyote	14055	14055
Rail Mount for Helmet - Coyote	14057	14057
	NSN-8470-01-633-3996	
Night Vision Goggle Mount -Tactical	14155	14155
Night Vision Goggle Mount -Aviation	14135	14135
	NSN-5340-01-641-3916	
Safety Wand - Glow in the dark	14902	14902
Elastic Headstrap	—	14059
E-Mount (ACH, ECH, MICH, LWH compatible)	14136	14136
	NSN-5340-01-641-3930	
E-Mount Access Kit (Includes E-Mount, MOLLE Retainer and paracord)	14137	14137
Paracord	14138	14138
Sidewinder Rescue Access Kit (Includes MOLLE Retainer and paracord)	14139	14139
Helmet Mount Kit-Coyote Helmet Mount, Headstrap, and MOLLE plate	14112	14112
Rail Mount Kit-Coyote Rail Mount, Headstrap and MOLLE plate	14113	14113
CR123 Batteries	2 Pk. 85175 6 Pk. 85180 12 Pk. 85177 400 Pk. 85179	

SIDEWINDER COMPACT® II

Extremely versatile lighting tool with white light and a variety of color LEDs for multiple tasks. Fits in the palm of your hand, or clips to MOLLE vest, belt, hat brim or pocket. Helmet mount also available. Entire body rotates 185° for easy aiming of light. Unbreakable, scratch-resistant lens. Special design for easy operation even when wearing heavy gloves. IPX7 rated waterproof to 1 meter for 30 minutes. 3 meter impact-resistance tested. O-ring and gasket-sealed for waterproof operation. Meets MIL-STD-810F, METHOD 512.4.



Operates on a AA Alkaline, AA Lithium or CR123A Lithium battery

Military Model

White LED
Blue LED
IR/IFF LED
Red LED

NVG Mount - Aviation

Aviation Model

White LED
Blue LED
IR/IFF LED
Green LED

SIDEWINDER COMPACT II

MULTIPLE POWER SOURCES:

(1) "CR123A" lithium, or (1) "AA" Alkaline, or (1) "AA" lithium
SIZE: 3" x 1.07" x 2.04" (7.62 x 2.72 x 5.21 cm)

WEIGHT: 2.4 oz (68 g) // 3.3 oz (94 g) w/Helmet Mount

COLOR: Coyote

	HIGH W/CR123 LITHIUM	HIGH W/"AA" LITHIUM	HIGH W/"AA" ALKALINE
LUMENS:	55	47	47
CANDELA:	1,175	1,000	1,000
DISTANCE:	69m	63m	63m
RUN TIME:	6h	6h	2h



The Sidewinder Compact II is designed for versatility. It can operate on a "AA" Lithium, "AA" alkaline or CR123 Lithium battery.

Military Model (White, Red, Blue, IR LEDs)

14516	Light only. Boxed.
14510	with Helmet Mount. Boxed.
14512	with Helmet Mount and Elastic Headstrap. Clam.
14513	with E-Mount. Clam packaged.
14514	with Helmet Mount and Elastic Headstrap. Boxed.
14515	Green, Blue, IR LEDs with Night Vision Goggle Mount. Boxed.
14518	with Helmet and Rail Mount.

Aviation Model (White, Green, Blue, IR LEDs)

14531	with Rail Mount and Elastic Headstrap.
14532	with Helmet Mount and Elastic Headstrap, AA Battery. Boxed.
14533	with Night Vision Goggle Mount. Boxed.

HEADLAMP SERIES //

HANDS-FREE LIGHTING SPECIALISTS

BECAUSE WORK IS TOUGH ENOUGH WITHOUT HAVING TO WORRY ABOUT YOUR LIGHTING.

Streamlight headlamps are available in a complete line suited to fill the needs of everyone from heavy industrial use to casual hiker. We build features into our lights that help you light your way exactly how and where you need. Spot beams for distance or flood beams for area lighting, and USB or multi-fuel options allowing you to chose the perfect light for your needs.

ProTac HL® USB



ENDURO® PRO HAZ-LO®



BANDIT®



STREAMLIGHT THE WIDEST RANGE OF HANDS-FREE LIGHTS

Streamlight proudly builds headlamps for all types of users... from those needing safety-rated models for use in hazardous locations or the weekend hiker needing a little extra light to setup the tent at the end of a long day on the trail. Our choices of beam types, light output and run-time ensures you'll be able to find exactly the light you need.

RECHARGEABLE MODELS

LISTED BY TYPE

SPOT / FLOOD MODELS

KEY ATTRIBUTES:
Multi-Function
Task Lighting
General Use
Multi-Purpose



FLOOD MODELS

KEY ATTRIBUTES:
Arm's Length
Task Lighting
Wide, Smooth Light

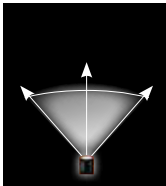

SPOT MODELS

KEY ATTRIBUTES:
Down Range
Long Distance

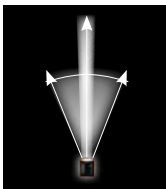

DOUBLE CLUTCH™ USB



TWIN-TASK® USB



BANDIT®



BANDIT® PRO



PROTAC HL® USB

LISTED BY FEATURE

SPECIALTY / COLOR LEDs

KEY ATTRIBUTES:
Preserve Night Vision
Won't Spook Game



BANDIT® — COYOTE
WHITE/RED LED



BANDIT® — COYOTE
WHITE/GREEN LED



NON-RECHARGEABLE MODELS



DOUBLE CLUTCH™ ALKALINE TWIN-TASK® 3AA TRIDENT® TRIDENT® HAZ-LO® ENDURO® PRO ENDURO® PRO HAZ-LO®



SEPTOR® SEPTOR® HAZ-LO® PROTAC HL®



ARGO® ARGO® HAZ-LO® 3AA HAZ-LO® ENDURO®



ENDURO® PRO — COYOTE WHITE/GREEN LED ENDURO® PRO WHITE/RED LED GREEN TRIDENT® BUCKMASTERS® TRIDENT®



BANDIT®

This USB COB headlamp is an ultra lightweight, weather resistant, personal area/work light featuring a large button for easy actuation, and a Lithium Polymer rechargeable battery. A rubber plug keeps dirt and debris out of the micro USB charging port. It includes a handy snap in hat clip adaptor to attach the light on the brim of a baseball cap or to add additional downward adjustability when using the headband. High, Low and Emergency flash modes on Yellow, Black, Red and Blue models.

BANDIT

BATTERY: Lithium Polymer Rechargeable

SIZE: 2.7" x 1.13" x .75" (6.85 x 2.87 x 1.9 cm)

WEIGHT: 1.3 oz (36.8 g)

COLOR: Yellow, Black, Red, Blue or Coyote

Yellow, Black, Red & Blue Models: White LED



WHITE LED	HIGH	LOW
LUMENS:	180	35
RUN TIME:	2h	9h 30m

Yellow, Black, Red & Blue models:
Emergency flash on high



Includes a handy snap-in hat clip adaptor to attach the light on the brim of a baseball cap or to add additional downward adjustability when using the headband.

RED LED	HIGH	LOW
LUMENS:	45	10
RUN TIME:	2h 30m	10h

Coyote Models: White/Red LED
White/Green LED

GREEN LED	HIGH	LOW
LUMENS:	135	25
RUN TIME:	3h	13h 30m



61700	w/Headstrap and USB cord—Yellow
61702	w/Headstrap and USB cord—Black
61704	w/Headstrap and USB cord—Blue
61705	w/Headstrap and USB cord—Red
61706	w/Headstrap and USB cord—Coyote / Red LED — Clam
61707	w/Headstrap and USB cord—Coyote / Green LED — Clam

BANDIT® INDUSTRIAL

All the great features of the Bandit® USB headlamp in an industrial-specific package. Includes elastic strap, rubber hard hat strap and 3M® Dual Lock® Fasteners for strapless mounting to a hard hat.

BANDIT INDUSTRIAL

BATTERY: Lithium Polymer Rechargeable

SIZE: 2.7" x 1.13" x .75" (6.85 x 2.87 x 1.9 cm)

WEIGHT: 1.3 oz (36.8 g)

COLOR: Yellow

61703 with elastic headstrap, rubber hard hat strap, 3M® Dual Lock® reclosable fasteners, and USB cord—Yellow



NEW

	HIGH	LOW
LUMENS:	180	35
RUN TIME:	2h	9h 30m



Includes a rubber head strap that ensures a non-slip grip for hard hats and 3M® Dual Lock® reclosable fasteners.

3M® and Dual Lock® are registered Trademarks of the 3M Company.

THE BANDIT FAMILY OF HEADLAMPS

ULTRA-COMPACT AND ULTRA-COMPLETE.

USED AT THE CAMPGROUND OR THE PROVING GROUND.

BANDIT® PRO

The Bandit® Pro USB headlamp builds on the favorite Bandit® COB headlamp with the added benefits of an extended runtime and a low runtime battery function. It includes a handy snap-in hat clip adaptor to attach the light on the brim of a baseball cap or to add additional downward adjustability when using the headband.

BANDIT PRO

BATTERY: Lithium Polymer Rechargeable

SIZE: 2.7" x 1.13" x .97" (6.85 x 2.87 x 2.46 cm)

WEIGHT: 1.6 OZ (45.4 g)

COLOR: Yellow or Black

61711	USB cord, hat clip and elastic headstrap - Box - Yellow
61710	USB cord, hat clip and elastic headstrap - Clam - Yellow
61714	USB cord, hat clip and elastic headstrap - Clam - Black
61715	USB cord, hat clip and elastic headstrap - Box - Black



	HIGH	LOW
LUMENS:	180	35
RUN TIME:	4h 30m	21h



Multi-function push-button switch with charge indicator - shines red when charging, green when charged

Includes a handy snap-in hat clip adaptor to attach the light on the brim of a baseball cap or to add additional downward adjustability when using the headband.



BANDIT® PRO INDUSTRIAL

All the great features of the Bandit® Pro USB headlamp in an industrial-specific package. Includes elastic strap, rubber hard hat strap and 3M® Dual Lock® Fasteners for strapless mounting to a hard hat.

BANDIT PRO INDUSTRIAL

BATTERY: Lithium Polymer Rechargeable

SIZE: 2.7" x 1.13" x .97" (6.85 x 2.87 x 2.46 cm)

WEIGHT: 1.6 OZ (45.4 g)

COLOR: Yellow or Black

61716	with elastic headstrap, rubber hard hat strap, 3M® Dual Lock® reclosable fasteners, and USB cord - Box - Yellow
-------	---



	HIGH	LOW
LUMENS:	180	35
RUN TIME:	4h 30m	21h



Includes a rubber head strap that ensures a non-slip grip for hard hats and 3M® Dual Lock® reclosable fasteners.



ENDURO PRO HEADLAMPS ARE JUST LIKE YOU. THEY PUT THEIR HEAD DOWN AND GET TO WORK.

ENDURO® PRO

The Enduro Pro AAA Headlamp features two power LEDs, and two colored LEDs. This headlamp is as versatile as it is durable. The Enduro Pro features eight output modes — three levels of spot or flood and two for the night vision colored LEDs. 45° tilting head design. Snap-on front fascia plate is included and allows you to easily change color. IPX4 water-resistant rated and 2m impact resistance tested.

ENDURO PRO HEADLAMP

BATTERY: (3) "AAA" alkaline

SIZE: 1.85" x 2.19" x 1.45"
(4.70 x 5.56 x 3.68 cm)

WEIGHT: 3.4 OZ (96.38 g)

COLOR: Black with Yellow Fascia or Coyote Fascia

61420	Black/Yellow w/ (3) alkaline—elastic headstrap—clam
61421	Black/Yellow w/ (3) alkaline—elastic headstrap—box
61425	Black/Coyote green LED w/ (3) alkaline—elastic headstrap—box

Yellow Model:
White /Red LED



Coyote Model:
White /Green LED

Remove yellow or coyote fascia to switch to black

WHITE SPOT	HIGH	MED	LOW
LUMENS:	200	75	25
CANDELA:	2,250	825	300
DISTANCE:	95m	57m	35m
RUN TIME:	6h	14h	38h

RED LED	HIGH	LOW
LUMENS:	.37	.08

WHITE FLOOD	HIGH	MED	LOW
LUMENS:	135	45	15
CANDELA:	210	80	20
DISTANCE:	29m	18m	9m
RUN TIME:	6h	14h	38h

GREEN LED	HIGH	LOW
LUMENS:	1.25	.25

ENDURO® PRO INDUSTRIAL

All the great features of the Enduro® Pro headlamp in an industrial-specific package. Includes elastic strap, rubber hard hat strap and 3M® Dual Lock® Fasteners for strapless mounting to hard hat. Three modes: spot for distance, flood for area illumination, red light for night vision preservation.

ENDURO PRO INDUSTRIAL HEADLAMP

BATTERY: (3) "AAA" alkaline

SIZE: 1.85" x 2.19" x 1.45"
(4.70 x 5.68 x 3.68 cm)

WEIGHT: 3.4 OZ (96.38 g)

COLOR: Black with Yellow Fascia

61422 with elastic headstrap, rubber hard hat strap, 3M® Dual Lock® reclosable fasteners, and USB cord—Yellow

SPOT	HIGH	MED	LOW	FLOOD	HIGH	MED	LOW
LUMENS:	200	75	25	LUMENS:	135	45	15
CANDELA:	2,250	825	300	CANDELA:	210	80	20
DISTANCE:	95m	57m	35m	DISTANCE:	29m	18m	9m
RUN TIME:	6h	14h	38h	RUN TIME:	6h	14h	38h



NEW

Includes a rubber head strap that ensures a non-slip grip for hard hats and 3M® Dual Lock® reclosable fasteners.

ENDURO® PRO HAZ-LO®

This intrinsically safe, high performance 3 AAA battery powered headlamp features two power LEDs. There are a total of three output modes, Spot, Flood and Spot/Flood Combo for maximum brightness. The flood LED is strategically placed high on the light for shadow free lighting when mounted on a hard hat. The headband design is optimized for easy removal for cleaning.

ENDURO PRO HAZ-LO HEADLAMP

BATTERY: (3) "AAA" alkaline

SIZE: 2.0" x 2.19" x 1.5"
(5.08 x 5.68 x 3.81 cm)

WEIGHT: 3.5 OZ (99.2 g)

COLOR: Yellow



Class 1, Division 1, Groups A,B,C,D;
Class II, Division 1, Groups E,F,G;
Class III, T-Class: T4 Exia.
(approved for use with Energizer E92,
Duracell MN2400, Rayovac NO.824,
and Panasonic LR03PA.)

61424 with elastic headstrap, rubber hard hat strap, 3M® Dual Lock® reclosable fasteners—Yellow

	SPOT	FLOOD	SPOT/FLOOD COMBO
LUMENS:	160	160	235
CANDELA:	1,320	100	—
DISTANCE:	73m	20m	—
RUN TIME:	5h	5h	4h 45m



NEW



Includes a rubber head strap that ensures a non-slip grip for hard hats and 3M® Dual Lock® reclosable fasteners.

ENDURO®

The Enduro® is ultralight and super comfortable. It features an integrated rubber/elastic combination head strap and a clip that attaches to the brim of your hat, coat lapel or car visor. Unbreakable lens. O-ring sealed, waterproof to 1 meter for 1 hour. Impact-resistant housing – drop-test verified. Maximum light output throughout battery life.

ENDURO HEADLAMP

BATTERY: (2) "AAA" alkaline

SIZE: 1.3" x 2.25" x 1.6"
(3.25 x 5.7 x 4 cm)

WEIGHT: 2.75 oz (78.5 g)

COLOR: Black or RealTree® Hardwoods® Green High Definition (HD)

61400 with alkaline batteries—elastic strap and visor clip—Black
61405 with alkaline batteries—elastic strap and visor clip—Camo



BLACK & CAMO MODEL

WHITE LED HIGH LOW

LUMENS: 50 10

CANDELA: 1,100 285

DISTANCE: 66m 33m

RUN TIME: 5h 30m 25h

Includes integrated rubber/elastic combination head strap and a clip that attaches to the brim of your hat, coat lapel or car visor.



THE DOUBLE CLUTCH.
SPOT TO FLOOD
IN ONE EASY **SHIFT.**



STREAMLIGHT TECHNOLOGY:
DECADES OF ILLUMINATION
INNOVATION.



SHIFT BEAMS //

- SHIFTS EASILY TO SPOT OR FLOOD MODES WITH THE TURN OF THE WRIST
- GLOVE-FRIENDLY FACECAP ROTATION



SHIFT BATTERIES //

- USB RECHARGEABLE LITHIUM POLYMER OR "AAA" BATTERIES

SHIFT BRIGHTNESS //

- DOUBLE SHIFT FOR HIGH TO LOW IN SPOT OR FLOOD MODES.
- 125 LUMENS ON HIGH. 30 LUMENS ON LOW.

DOUBLE CLUTCH™ USB HEADLAMP

This dual-power, dual-function, dual-output headlamp gives you the flexibility of using either a USB-rechargeable battery or 3 AAA alkaline batteries. It also lets you choose either a spot or a flood beam, both with high and low mode. It's lightweight and long-running with a 60° tilting head. Unbreakable lens. IPX4 rated. Water-resistant. 2 meter impact resistance tested.

DOUBLE CLUTCH USB

BATTERY: Rechargeable Lithium Polymer pack or (3) "AAA" alkaline or lithium batteries

SIZE: 1.75" x 2.50" x 1.66"
(4.44 x 6.35 x 4.22 cm)

WEIGHT: 4.0 OZ (113 g)

COLOR: Yellow or Black



Includes a rubber head strap that ensures a non-slip grip for hard hats.



LITHIUM POLYMER	HIGH	LOW
LUMENS:	125	30
SPOT DIST:	82m	40m
SPOT CANDELA:	1,700	400
FLOOD DIST:	31m	4m
FLOOD CANDELA:	250	70
RUN TIME:	3h 30m	10h

ALKALINE "AAA"	HIGH	LOW
LUMENS:	125	30
SPOT DIST:	82m	40m
SPOT CANDELA:	1,700	400
FLOOD DIST:	31m	4m
FLOOD CANDELA:	250	70
RUN TIME:	6h	18h

YELLOW BLACK

61602	61603	120V AC with elastic and rubber straps
61600	61601	with USB Cord (only)
61607	61608	Alkaline Model

ACCESSORIES

22058	22058	120V AC Wall Adapter
22070	22070	USB Cord
61604	61604	Lithium Polymer Battery

PROTAC HL HEADLAMPS

DELIVERING HIGH-LUMEN PERFORMANCE AND LONG-RANGE LIGHTING.

PROTAC HL® USB HEADLAMP

This 1,000 lumen headlamp is a bright USB rechargeable hands-free lighting solution. TEN-TAP® programming lets you choose the order of operating modes. Includes diffuser lens for spot/flood functionality. IPX4 rated for water resistance. 1 meter impact-resistance tested. Maximum light output throughout battery life. Includes red and green lenses. The Lithium Ion rechargeable battery is the only rechargeable battery that can be recharged while in the headlamp.

	HIGH	MEDIUM	LOW
LUMENS:	1,000	400	65
CANDELA:	13,500	5,400	900
DISTANCE:	232m	147m	60m
RUN TIME:	1h 45m	3h 30m	24h

1,000 LUMENS HL SERIES

HL®



TEN-TAP® programmable switch allows user selection of one of three different programs:

- high/medium/low (factory default)
- high only
- low/medium/high

MULTI-FUEL DESIGN: Runs on a Strion rechargeable battery (included) or (1) 18650 battery

PROTAC HL USB HEADLAMP

BATTERY: Includes Rechargeable Lithium Ion, also accepts (1) Streamlight 18650 Li-Ion rechargeable (does not charge in light)
SIZE: 4.03" x 1.20" x 3.12" (10.23 x 3.05 x 7.92 cm)
WEIGHT: 8.1 OZ (230 g)
COLOR: Black

61305	ProTac HL USB Headlamp— Black
61306	ProTac HL USB Headlamp 120V AC— Black

ACCESSORIES

22101	18650 Battery with USB port - 1 pack
22102	18650 Battery with USB port - 2 pack
22100	18650 Battery Charge Cradle
22070	USB cord - 40"
22081	USB cord - 22"

PROTAC HL® HEADLAMP

The perfect light for when your task requires both hands and a bright light with a wide, long-range beam. 90° tilting head reduces neck fatigue. TEN-TAP® programming lets you choose the order of operating modes. IPX4 rated for water resistance. 1 meter impact-resistance tested. Maximum light output throughout battery life.

	HIGH	MEDIUM	LOW
LUMENS:	635	105	20
CANDELA:	8,500	1,450	280
DISTANCE:	184m	76m	33m
RUN TIME:	1h 45m	8h	36h



TEN-TAP® programmable switch allows user selection of one of three different programs:

- high/medium/low (factory default)
- high only
- low/medium/high

Includes a rubber head strap that ensures a non-slip grip for hard hats.

HL®
635 LUMENS HL SERIES



PROTAC HL HEADLAMP

BATTERY: (2) 3V "CR123A" lithium
SIZE: 3.66" x 1.2" x 2.6"
 (2.54 x 3.05 x 6.60 cm)
WEIGHT: 6.6 OZ (187 g)
COLOR: Black

61304 with lithium batteries and elastic and rubber straps— Black



STREAMLIGHT HEADLAMPS GIVE YOU THE
VERSATILITY AND THE BRIGHTNESS
YOU NEED TO ACCOMPLISH ANY TASK.

ARGO®

	HIGH	MED	LOW
LUMENS:	150	100	45
CANDELA:	9,250	6,375	2,750
DISTANCE:	190m	160m	103m
RUN TIME:	3h	4h 30m	30h



Includes a rubber head strap that ensures a non-slip grip for hard hats.

Featuring an intense, long-distance beam for down range illumination with 3 levels of output.

ARGO HEADLAMP

BATTERY: (3) "AAA" alkaline
SIZE: 1.75" x 2.70" x 2.40"
(4.45 x 6.85 x 6.09 cm)
WEIGHT: 5.4 oz (153 g)
COLOR: Yellow



Class I, Div. 2, Groups A, B, C, D;
Class II, Div. 2, Groups F, G,
Class III, T5

61301 with alkaline batteries—rubber and elastic straps—Yellow

ARGO® HAZ-LO®

With its intense, long-distance beam that reaches as far as 113 meters, and its Class 1, Division 1 safety rating, the Argo® HAZ-LO® headlamp is ideal any where you need hands-free lighting, even in hazardous environments. Intrinsically safe and offers 2 lighting modes and a 90° tilting head. Unbreakable lens. IPX4 rated for water-resistance. 2 meter impact-resistance tested.

	HIGH	LOW
LUMENS:	90	20
CANDELA:	3,200	700
DISTANCE:	113m	53m
RUN TIME:	8h	50h



90° tilting head with a durable ratcheting system.

Includes a rubber head strap that ensures a non-slip grip for hard hats.

ARGO HAZ-LO HEADLAMP

BATTERY: (3) "AAA" alkaline
SIZE: 1.75" x 2.70" x 2.40"
(4.45 x 6.85 x 6.09 cm)
WEIGHT: 5.4 oz (153 g)
COLOR: Yellow



Class 1, Division 1, Groups A,B,C,D;
Class II, Division 1, Groups E,F,G;
Class III, T-Class: T4 Exia

61026 with alkaline batteries—rubber and elastic straps—Yellow

SEPTOR®

The Septor headlamp is your ideal choice when you need a hands-free flood light for close-up tasks or tasks at arm's length. It gives you 120 lumens of a soft, wide beam to illuminate your work area.

SEPTOR HEADLAMP

BATTERY: (3) "AAA" alkaline

SIZE: 1.75" x 2.70" x 2.40"
(4.45 x 6.85 x 6.09 cm)

WEIGHT: 5.5 oz (156 g)

COLOR: Yellow



Class I, Div. 2, Groups A, B, C, D;
Class II, Div. 2, Groups F, G,
Class III, T5

61052 with alkaline batteries—rubber and elastic straps—Yellow

	HIGH	MED	LOW
LUMENS:	120	45	13
CANDELA:	900	375	100
DISTANCE:	60m	35m	20m
RUN TIME:	3h 30m	10h	55h



Includes a rubber head strap that ensures a non-slip grip for hard hats.

SEPTOR® HAZ-LO®

The perfect headlamp for close-up tasks or tasks at arm's length is now safe to use in hazardous locations and is intrinsically safe. 90° tilting head. High and low lighting modes. Unbreakable lens. IPX4 rated for water-resistance. 2 meter impact-resistance tested.

SEPTOR HAZ-LO HEADLAMP

BATTERY: (3) "AAA" alkaline

SIZE: 1.75" x 2.70" x 2.40"
(4.45 x 6.85 x 6.09 cm)

WEIGHT: 5.5 oz (156 g)

COLOR: Yellow



Class I, Div 1, Groups A,B,C,D;
Class II, Div 1, Groups E,F,G;
Class III; T-Class: T4 Exia

61024 with alkaline batteries—rubber and elastic straps—Yellow

	HIGH	LOW
LUMENS:	85	20
CANDELA:	620	150
DISTANCE:	50m	24m
RUN TIME:	8h	50h



Includes a rubber head strap that ensures a non-slip grip for hard hats.



90° tilting head with a durable ratcheting system.



3AA HAZ-LO® HEADLAMP

This compact, long-running, high-performance headlamp meets the stringent requirements of Div. 1 hazardous locations. Exceptional light output. Long run time. Unbreakable, O-ring sealed lens. Easy operation even when wearing heavy gloves. Impact-resistant housing – 1 meter drop-test verified. Intrinsically safe.

3AA HAZ-LO

BATTERY: (3) "AA" alkaline

SIZE: 1.88" x 2.5" x 3.08"
(4.76 x 6.35 x 7.82 cm)

WEIGHT: 7.1 oz (202 g)

COLOR: Yellow



Permissible Portable Headlamp Assembly
App. No. 20-A070001-0
Tested for use in methane-air mixtures only



Class I, Div. 1, Groups A,B,C,D;
Class II, Div. 1, Groups E,F,G,
Class III, T4

61200 with alkaline batteries—rubber and elastic straps—Yellow

LUMENS:	120
CANDELA:	6,800
DISTANCE:	165m
RUN TIME:	11h



Includes a rubber head strap that ensures a non-slip grip for hard hats.



90° tilting head with a durable ratcheting system.



TRIDENT®

The Trident multi-purpose headlamp offers the versatility of switching between either a bright light to illuminate objects at a distance (126 meters) or a soft flood light for tasks at arm's length.

TRIDENT HEADLAMP

BATTERY: (3) "AAA" alkaline

SIZE: 1.75" x 2.70" x 2.40"
(4.45 x 6.85 x 6.09 cm)

WEIGHT: 5.50 oz (156 g)

COLOR: Yellow or Green or RealTree® Hardwoods® Green High Definition (HD)

THREE TRIDENT MODELS:

Yellow Model: Contains Power LED and three ultra-bright white LEDs

Green Model: Contains Power LED, one safety green LED, two white 5mm LEDs

Buckmasters Camo Model: RealTree® Hardwoods® Green High Definition camo; contains super-bright Power LED and three safety-green 5mm LEDs

TRIDENT HEADLAMP

61050	with White LEDs with alkaline batteries—Yellow
61051	2 White and 1 Green LED with alkaline batteries—Green
61070	3 Green LEDs with alkaline batteries—Camo

Safety-Rated Models



Class I, Div. 2, Groups A, B, C, D;
Class II, Div. 2, Groups F, G,
Class III, T5



Yellow

Model	POWER 3 LEDES	1 LED
LUMENS:	80	35
CANDELA:	4,000	385
DISTANCE:	126m	39m
RUN TIME:	5h	10h



90° tilting head with a durable ratcheting system.

Green

Model	POWER 2 LEDES	1 LED
LUMENS:	80	25
CANDELA:	4,000	275
DISTANCE:	126m	33m
RUN TIME:	5h	19h 30m



Includes a rubber head strap that ensures a non-slip grip for hard hats.

Camo

Model	POWER 3 LEDES	1 LED
LUMENS:	80	20
CANDELA:	4,000	175
DISTANCE:	126m	26m
RUN TIME:	5h	20h

TRIDENT® HAZ-LO®

Now you can safely use this multi-purpose headlamp in hazardous environments. The Class 1, Division 1 safety-rated Trident® HAZ-LO® headlamp is intrinsically safe and gives you the versatility to switch between a bright power LED to illuminate objects at a distance (102 meters!) or a soft flood light for close-up tasks. 90° tilting head. Unbreakable lens. IPX4 rated for water-resistance. 2 meter impact-resistance tested.

TRIDENT HAZ-LO HEADLAMP

BATTERY: (3) "AAA" alkaline

SIZE: 1.75" x 2.70" x 2.40"
(4.45 x 6.85 x 6.09 cm)

WEIGHT: 5.50 oz (156 g)

COLOR: Yellow

61025	with alkaline batteries—rubber and elastic straps—Yellow
-------	--



Class I, Div 1, Groups A,B,C,D;
Class II, Div 1, Groups E,F,G;
Class III; T-Class: T4 Exia.



Includes a rubber head strap that ensures a non-slip grip for hard hats.

	HIGH	LOW
LUMENS:	85	30
CANDELA:	2,600	300
DISTANCE:	102m	35m
RUN TIME:	8h	24h



90° tilting head with a durable ratcheting system.





THE NEW TWIN-TASK HEADLAMPS MULTI-USE AND MULTI-POWER — THEY'RE AS FLEXIBLE AS THEIR ELASTIC STRAPS.

TWIN-TASK® USB HEADLAMP

With two light sources to choose from, the Twin-Task® USB Headlamp is a versatile headlamp for any task. With its 375 lumen main beam for distance spotting and its 250 lumen COB flood LED it has just the right mode for your lighting needs. The ability to recharge the battery in the light or quickly change to a backup battery makes the light easily scalable for extended lighting use. With five lighting levels, the light is up to any task.



Low-profile, ergonomically balanced design; contoured battery pack for wearer comfort.

TWIN-TASK USB HEADLAMP

BATTERY: Rechargeable Lithium Ion

SIZE: 1.35" x 2.125" x 2.67"
(3.43 x 5.4 x 6.78 cm)

WEIGHT: 6.1 oz (173 g)

COLOR: Black/Red

51063 with USB Cord—and elastic strap—Clam—Black/Red

51064 with USB Cord—and elastic strap—Box—Black/Red

SPOT	HIGH	MED	LOW
LUMENS:	375	175	50
CANDELA:	3,650	1,850	440
DISTANCE:	121m	86m	42m
RUN TIME:	4h 45m	8h 30m	20h

COB FLOOD	HIGH	LOW
LUMENS:	250	125
CANDELA:	160	80
DISTANCE:	25m	18m
RUN TIME:	5h	9h

TWIN-TASK® 3AA HEADLAMP

With two light sources to choose from, the Twin-Task® Headlamp is a versatile headlamp for any task. With its 300 lumen main beam for distance spotting and its 250 lumen COB flood LED, it has just the right mode for your lighting needs. With five lighting levels, the light is up to any task.



Uses three "AA" alkaline batteries (included).

TWIN-TASK 3AA HEADLAMP

BATTERY: (3) "AA" alkaline

SIZE: 1.35" x 2.125" x 2.67"
(3.43 x 5.4 x 6.78 cm)

WEIGHT: 7.6 oz (215 g)

COLOR: Black/Red

51061 with alkaline batteries—and elastic strap—Clam—Black/Red

51062 with alkaline batteries—and elastic strap—Box—Black/Red

SPOT	HIGH	MED	LOW
LUMENS:	300	100	50
CANDELA:	2,900	1,000	500
DISTANCE:	108m	63m	45m
RUN TIME:	4h 15m	20h	38h

COB FLOOD	HIGH	LOW
LUMENS:	250	125
CANDELA:	140	80
DISTANCE:	24m	18m
RUN TIME:	3h 30m	7h 30m

STYLUS & SPECIALTY SERIES //



REDEFINING PORTABLE LIGHTING

YOUR JOB HAS CHANGED, BUT THE NEED FOR SMALL, VERSATILE AND EFFECTIVE LIGHTING HASN'T.

We pride ourselves on identifying a need and building a product to suit it. Our Stylus is exactly one of those products. Small, compact, a long runtime and easily stowed. It's been seen just about everywhere from garages to TSA lanes. It's evolved into a full family of Stylus products with unique attributes that make them extra functional and suited for a variety of tasks. Same with our namesake Twin-Task and Task-light lines.



STYLUS®

STYLUS PRO®

STYLUS PRO® COB

MICROSTREAM®

STYLUS PRO REACH®

STREAMLIGHT JR. F-STOP®

KEYMATE® USB

THE STYLUS PRO SERIES
MORE OPTIONS
TO USE IN EVEN MORE
PLACES & WAYS!

STYLUS PRO® USB & USB UV

STYLUS PRO USB UV
UV LED OUTPUT: 325mW
UV RUN TIME: 2h 30m



Sliding metal sleeve protects micro USB port

Recharge by plugging into USB port or optional AC wall adapter

	HIGH	LOW
LUMENS:	250	90
CANDELA:	2,950	840
DISTANCE:	109m	58m
RUN TIME:	1h 30m	3h 30m

You won't want to be without this sleek, compact penlight that recharges at any USB port or with optional AC wall adaptor. Consistent light output throughout battery life. IPX4 water-resistant. 1 meter impact-resistance tested. Also available in a UV model.

STYLUS PRO USB & STYLUS PRO USB UV

BATTERY: Lithium ion
SIZE: 6.15" x .74" (15.6 x 1.9 cm)
WEIGHT: 1.9 OZ (53.8 g)
COLOR: Black

66133	Stylus Pro USB with 120V AC adapter, USB cord, nylon holster — Black with white LED
66134	Stylus Pro USB with USB cord, nylon holster — Black with white LED
66148	Stylus Pro USB UV with 120V AC adapter, USB cord, nylon holster
66149	Stylus Pro USB UV with USB cord, nylon holster

ACCESSORIES

22070	USB Cord
22071	120V AC Wall Adapter
66029	Nylon Holster

STYLUS PRO®



	WHITE LED	GREEN LED
LUMENS:	100	5
CANDELA:	950	73
DISTANCE:	62m	17m
RUN TIME:	8h	11h

Compact size, durable construction and optimum beam output make this an ideal light for multiple tasks. Unbreakable lens. O-ring sealed. IPX4 rated for water-resistance. 1 meter impact-resistance tested. Removable pocket clip.

STYLUS PRO

BATTERY: [2] "AAA" alkaline
SIZE: 5.3" x .6" (13.4 x 1.5 cm)
WEIGHT: 1.64 OZ (46.9 g)
COLOR: Matte Black, Silver, Red, Blue, Lime Green, Orange or RealTree® Hardwoods® Green High Definition (HD)

66118	White LED — Matte Black
66121	White LED — Silver
66120	White LED — Red
66122	White LED — Blue
66129	White LED — Lime Green
66128	White LED — Orange
66124	Green LED — RealTree® Hardwoods® Green HD Camo

ACCESSORIES

66028	Nylon Holster
-------	---------------



STYLUS PRO® COB

A sleek, compact, USB rechargeable worklight that you can wear. Clip it to your pocket for hands-free lighting. Don't have a pocket? Stick it to a steel surface using its integrated magnet. Slim profile fits into tight spaces to flood the work area with light.

STYLUS PRO COB

BATTERY: Lithium ion

SIZE: 6.64" x .55" (168.6 x 14 mm)

WEIGHT: 2.2 oz (62.4 g)

COLOR: Black, Red or Blue

66700 includes pocket clip and USB cord - Clam - Black

66702 includes pocket clip and USB cord - Box - Black

66703 includes pocket clip and USB cord - Clam - Red

66705 includes pocket clip and USB cord - Box - Red

66706 includes pocket clip and USB cord - Clam - Blue

66708 includes pocket clip and USB cord - Box - Blue

ACCESSORIES

66143 Lithium Ion Battery (Stylus Pro USB/COB)

22070 40" USB Cord

22071 120V AC USB Cord

22079 5" USB Cord

22081 22" USB Cord

22059 International Wall Adapter

22069 12V DC USB Adapter

22600 EPU-5200

66029 Nylon Holster



COB LED floods work area with bright, diffused light

Integrated magnet for hands-free use



Push-button switch with charge indicator
Red = charging
Green = charged

	HIGH	LOW
LUMENS:	160	40
CANDELA:	130	30
DISTANCE:	23m	11m
RUN TIME:	3h	8h 30m

Flash mode: 7 hours of run time

STYLUS PRO® 360

Versatile light functions as a typical Stylus Pro or adjust the head to reveal the 360° feature. Equipped with a rubber tail boot that allows the light to stand upright. It features a tail cap switch, momentary or constant on operation, a pocket clip for convenience, and amazing brightness and run time for a light of its size and price.

STYLUS PRO 360

BATTERY: (2) "AAA" alkaline

SIZE: 5.9" x .64" (150 x 16.25 cm)

WEIGHT: 1.9 oz (53.8 g)

COLOR: Black

66218 Stylus Pro 360—Black

LUMENS:	65
CANDELA:	430
DISTANCE:	41m
RUN TIME:	6h 30m



Rubber tail boot allows the light to stand upright

The 360° feature allows the light to be used as a small lantern



MICROSTREAM®

So small, you can keep it in your pocket or clip it to a cap for hands-free lighting. Ideal if you carry a lot of gear and don't want to be weighed down. Unbreakable lens. O-ring sealed. IPX4 rated for water-resistance. 1 meter impact-resistance tested. Removable pocket/hat clip.

MICROSTREAM

BATTERY: [1] "AAA" alkaline

SIZE: 3.5" x .6" (9.15 x 1.5 cm)

WEIGHT: 1.10 oz (31.2 g)

COLOR: Matte Black or Red

66318 White LED — Black

66323 White LED — Red

MICROSTREAM® USB

This compact USB lithium ion battery powered flashlight features a tail cap switch, momentary or constant on operation, high and low beams, a combination pocket/hat clip for convenience, and amazing brightness and run time for a light of its size. The aluminum housing with Type II Military Spec anodizing helps make the light extremely durable and abrasion resistant. To charge the light, slide the head cover forward to expose the micro USB port.

MICROSTREAM USB

BATTERY: Li-Ion rechargeable

SIZE: 3.87" x .61" (98.2 x 15.6 cm)

WEIGHT: 1.2 oz (34.1 g)

COLOR: Black, Red, Blue or Coyote

66601	includes wrist lanyard, hat clip and USB cord - Clam - Black
66604	includes wrist lanyard, hat clip and USB cord - Box - Black
66602	includes wrist lanyard, hat clip and USB cord - Clam - Red
66605	includes wrist lanyard, hat clip and USB cord - Box - Red
66603	includes wrist lanyard, hat clip and USB cord - Clam - Blue
66606	includes wrist lanyard, hat clip and USB cord - Box - Blue
66608	includes wrist lanyard, hat clip and USB cord - Clam - Coyote
66609	includes wrist lanyard, hat clip and USB cord - Box - Coyote

ACCESSORIES

22070	40" USB Cord
22081	22" USB Cord
22079	5" USB Cord
66607	MicroStream USB Battery
22600	EPU-5200™ Portable USB Charger

LUMENS:	45
CANDELA:	420
DISTANCE:	41m
RUN TIME:	2h 15m



	HIGH	LOW
LUMENS:	250	50
CANDELA:	1,150	250
DISTANCE:	68m	31m
RUN TIME:	1h 30m	3h 30m



Sliding metal sleeve protects micro USB port



STYLUS®

This bright, long-running LED penlight has a long battery life, and goes anywhere you need it. IPX4 rated for water-resistance. Removable pocket clip.

STYLUS

BATTERY: (3) "AAAA" alkaline

SIZE: 6.21" x .375" (15.17 x .95 cm)

WEIGHT: 1.1 OZ (31.19 g)

COLOR: Black, Gold, Silver, US Flag, Red or Blue

65006	Red LED—Black
65012	White LED—Silver
65018	White LED—Black
65020	Green LED—Black
65022	Blue LED—Black
65024	White LED—Gold
65035	White LED—Red
65050	White LED—Blue
65058	White LED—Black, UL Listed
65080	White LED—US Flag

ACCESSORIES

65030	AAAA Batteries—6 Pack
65905	Holster
72024	Lanyard with Push Button Slide
65031	Glare Guard



Intrinsic Safety for Haz. Loc.
Class I, Div. 1,
Groups A, B, C, D, T3C
"Classified"



Intrinsic Safety for Haz. Loc.
Class I, Div. 1,
Groups A, B, C, D, T3C
"Exia"

**SAFETY RATED
MODEL OFFERED**

LED COLOR:	WHITE	GREEN	BLUE	RED
LUMENS:	11	7	2	2
CANDELA:	140	59	110	53
DISTANCE:	24m	15m	21m	15m
RUN TIME:	24h	24h	24h	24h



SAFETY RATED MODEL OFFERED



STYLUS® UV

An ultraviolet penlight for fluorescent detection of fraudulent documents and for use in forensic investigations. IPX4 rated for water-resistance. Removable pocket clip.

STYLUS UV

BATTERY: (3) "AAAA" alkaline

SIZE: 6.21" x .375" (15.17 x .95 cm)

WEIGHT: 1.1 OZ (31.19 g)

COLOR: Black

65069	365nm UV LED—Black
-------	--------------------

ACCESSORIES

65030	AAAA Batteries—6 Pack
65905	Holster

OUTPUT:	3.8 mW
RUN TIME:	60h



THE STYLUS SERIES ELIMINATES HARD-TO-SEE NOOKS AND CRANNIES AND LIGHTS THE WAY.

STYLUS REACH®

LUMENS:	11
CANDELA:	140
DISTANCE:	24m
RUN TIME:	24h

Twist and turn the flexible cable into any position to light the most out-of-the-way places.



Features a high-intensity white LED and a 7" cable (providing 14" of reach) that allows you to see into the tightest spots. IPX4 rated for water-resistance. Pocket clip.

STYLUS REACH

BATTERY: (3) "AAAA" alkaline

SIZE: 14" x .375"
(35.6 x .95 cm)

WEIGHT: 1.7 oz (48.2 g)

COLOR: Black or Silver

SAFETY RATED
MODEL OFFERED

65618	White LED—Black
65658	White LED—UL Listed Black
65612	White LED—Silver

ACCESSORIES

65030	AAAA Batteries—6 Pack
-------	-----------------------



STYLUS REACH® 18

LUMENS:	11
CANDELA:	140
DISTANCE:	24m
RUN TIME:	24h



A textured grip for non-slip handling makes it easier to maneuver the light in slippery or wet conditions.

All the great features of the Stylus Reach® with a longer cable. With a total of 25" of reach, nothing is out of sight. IPX4 rated for water-resistance. Pocket clip.

STYLUS REACH 18

BATTERY: (3) "AAAA" alkaline

SIZE: 25" x .375"
(64 x .95 cm)

WEIGHT: 3.5 oz (99.2 g)

COLOR: Black

65418	White LED—18" Cable—Black
-------	---------------------------

ACCESSORIES

65030	AAAA Batteries—6 Pack
-------	-----------------------



SAFETY RATED
MODEL OFFERED



Intrinsic Safety for Haz. Loc.
Class I, Div. 1,
Groups A, B, C, D, T3C
"Classified"



Intrinsic Safety for Haz. Loc.
Class I, Div. 1,
Groups A, B, C, D, T3C
"Exia"



STYLUS PRO REACH®

We added an 8" PVC cable for extended reach and flexibility to our powerful Stylus Pro® penlight. It now provides 14" of reach to get intense light right where you need it. Unbreakable, scratch-resistant lens. O-ring sealed, shock-proof and drop-tested. IPX4 rated water-resistant. Removable pocket clip.

STYLUS PRO REACH
BATTERY: [2] "AAA" alkaline
SIZE: 14.6" x .6"
(37.1 x 1.5 cm)
WEIGHT: 2.7 oz (76.5 g)
COLOR: Matte Black

66418 White LED includes Clip Holder – Matte Black

LUMENS:	38
CANDELA:	825
DISTANCE:	57m
RUN TIME:	8h



A textured grip for non-slip handling makes it easier to maneuver the light in slippery or wet conditions.

Magnetic clip holder



TWIN-TASK® 3C



CHOOSE
FROM SPOT,
SPOT/FLOOD,
OR FLOOD

	SPOT	SPOT/FLOOD	FLOOD
LUMENS:	435	190	95
CANDELA:	6,600	1,500	70
DISTANCE:	162m	77m	17m
RUN TIME:	16h	19h	46h

The Twin-Task® 3C flashlight features three lighting modes. High, Low and Flood using the latest in COB LED technology. The power LED with its textured reflector provides an even beam, along with a piercing hotspot for distance. The Flood LED provides smooth even area lighting for your up close tasks with extended run time. Packaged with a high-strength lanyard.

TWIN-TASK 3C

BATTERY: [3] "C" alkaline
SIZE: 8.93" x 1.57" x 1.26"
(22.7 x 4.0 x 3.2 cm)
WEIGHT: 14.6 oz (414 g)
COLOR: Matte Black

51039	Matte Black - Box
51047	Matte Black - Clam

TWIN-TASK® 3AA



CHOOSE
FROM SPOT,
SPOT/FLOOD,
OR FLOOD

	SPOT	SPOT/FLOOD	FLOOD
LUMENS:	270	240	75
CANDELA:	3,680	3,000	60
DISTANCE:	121m	110m	15m
RUN TIME:	11h	12h	25h

The Twin-Task® 3AA flashlight features three lighting modes. High, Low and Flood using the latest in COB LED technology. The power LED with its textured reflector provides an even beam, along with a piercing hotspot for distance. The Flood LED provides smooth even area lighting for your up close tasks with extended run time. Packaged with a high-strength lanyard.

TWIN-TASK 3AA

BATTERY: [3] "AA" alkaline
SIZE: 8.75" x 1.33" x .79"
(22.22 x 3.38 x 2.0 cm)
WEIGHT: 7.1 oz (201 g)
COLOR: Matte Black

51038	with alkaline batteries. Matte Black - Box
51060	with alkaline batteries. Matte Black - Clam

THEY'RE CALLED TWIN-TASK, BUT THESE LIGHTS ARE SO VERSATILE, THEY SHOULD BE CALLED... **ANY-TASK.**

TWIN-TASK® 1L TWIN-TASK® 2L



TWIN-TASK 1L	SPOT	SPOT/FLOOD	FLOOD
LUMENS:	240	200	60
CANDELA:	3,650	2,700	40
DISTANCE:	121m	104m	13m
RUN TIME:	2h 30m	4h	5h 45m

CHOOSE
FROM SPOT,
SPOT/FLOOD,
OR FLOOD



TWIN-TASK 2L	SPOT	SPOT/FLOOD	FLOOD
LUMENS:	350	230	75
CANDELA:	4,900	2,580	60
DISTANCE:	140m	102m	15m
RUN TIME:	4h 45m	5h 45m	9h 45m

The Twin-Task® 1L and 2L flashlights feature three lighting modes. High, Low and Flood using the latest in COB LED technology. The power LED with its textured reflector provides an even beam, along with a piercing hotspot for distance. The Flood LED provides smooth even area lighting for your up close tasks with extended run time. Packaged with a high-strength lanyard.

TWIN-TASK 1L

BATTERY: (1) 3V "CR123A" lithium

SIZE: 4.24" x 1.33" x .98"
(10.77 x 3.38 x 2.49 cm)

WEIGHT: 4.2 oz (119 g)

COLOR: Matte Black

TWIN-TASK 2L

BATTERY: (2) 3V "CR123A" lithium

SIZE: 5.67" x 1.33" x .98"
(14.40 x 3.38 x 2.49 cm)

WEIGHT: 5.7 oz (162 g)

COLOR: Matte Black

TT-1L	TT-2L	
51036	51037	with lithium battery. Matte Black - Box
51048	51049	with lithium battery. Matte Black - Clam

TWIN-TASK® 3AAA



CHOOSE
FROM SPOT,
SPOT/FLOOD,
OR FLOOD

	SPOT	SPOT/FLOOD	FLOOD
LUMENS:	240	165	60
CANDELA:	4,200	2,000	50
DISTANCE:	130m	89m	14m
RUN TIME:	3h 30m	3h 15m	11h

The Twin-Task® 3AAA flashlight features three lighting modes. High, Low and Flood using the latest in COB LED technology. The power LED with its textured reflector provides an even beam, along with a piercing hotspot for distance. The Flood LED provides smooth even area lighting for your up close tasks with extended run time. Packaged with a high-strength lanyard.

TWIN-TASK 3AAA

BATTERY: (3) "AAA" alkaline

SIZE: 5.45" x 1.57" x 1.18"
(13.84 x 3.99 x 3.0 cm)

WEIGHT: 7.0 oz (198 g)

COLOR: Matte Black

51052	with alkaline batteries. Matte Black - Box
51050	with alkaline batteries. Matte Black - Clam

THE TWIN-TASK SERIES HAS
VERSATILITY
BUILT RIGHT IN.

TWIN-TASK® 3C-UV



CHOOSE FROM:
POWER LED,
6 UV LEDS
OR 3 UV LEDS.

	POWER LED	6 UV LED	3 UV LED
LUMENS:	185	40mw	30mw
CANDELA:	3,730	—	—
DISTANCE:	116m	—	—
RUN TIME:	27h	63h	81h

Three lighting modes include ultraviolet light for detection of fraudulent documents or engine and HVAC leaks. The white LED mode provides an even beam with a piercing hotspot for distance. Unbreakable lens. IPX4 rated for water-resistance. O-ring sealed. 1 meter impact-resistance tested.

TWIN-TASK 3C UV LED

BATTERY: (3) "C" alkaline
SIZE: 9.02" x 1.68" x 1.26"
(22.9 x 4.26 x 3.2 cm)
WEIGHT: 1 lb (449 g)
COLOR: Matte Black

51045 Matte Black

TWIN-TASK® 3AAA LASER



CHOOSE FROM:
POWER LED,
5 LEDS OR
LASER.

	POWER LED	5 LED
LUMENS:	100	68
CANDELA:	2,000	800
DISTANCE:	90m	57m
RUN TIME:	2h 45m	5h 15m

Features a mode with piercing brightness and a hotspot for distance, plus a mode for ultra-bright area lighting and extended runtime. Also includes a red laser pointer. Unbreakable lens. IPX4 rated for water-resistance. O-ring sealed. 1 meter impact-resistance tested.

TWIN-TASK 3AAA LASER LED

BATTERY: (3) "AAA" alkaline
SIZE: 5.38" x 1.57" x 1.17"
(13.69 x 3.98 x 2.98 cm)
WEIGHT: 7.04 oz (200 g)
COLOR: Matte Black

51043 with alkaline batteries. Matte Black.



TASK-LIGHT® 3AA

The long life of an LED with the longer range and brighter beam of a conventional high-powered light. Unbreakable lens. O-ring sealed for water-resistance. Drop-tested.

TASK-LIGHT 3AA

BATTERY: [3] "AA" alkaline

SIZE: 8.60" x 1.33" x .79"
(21.7 x 3.38 x 2.01 cm)

WEIGHT: 6.4 OZ (180 g)

COLOR: Matte Black or Titanium



51006 with alkaline batteries. Matte Black.

51016 with alkaline batteries. Titanium.

LUMENS:	95
CANDELA:	1,600
RUN TIME:	16h



MULTI OPS®

An ultra-bright white light, or [5] UV LEDs for fluid detection, and a laser pointer all in one. IPX4 rated for water-resistance. All openings are O-ring or gasket sealed. 1 meter impact-resistance tested.

MULTI-OPS

BATTERY: [3] "AAA" alkaline

SIZE: 5.38" x 1.57" x 1.17"
(13.69 x 3.98 x 2.98 cm)

WEIGHT: 7.04 oz (200 g)

COLOR: Matte Black

51072 with alkaline batteries. Matte Black.

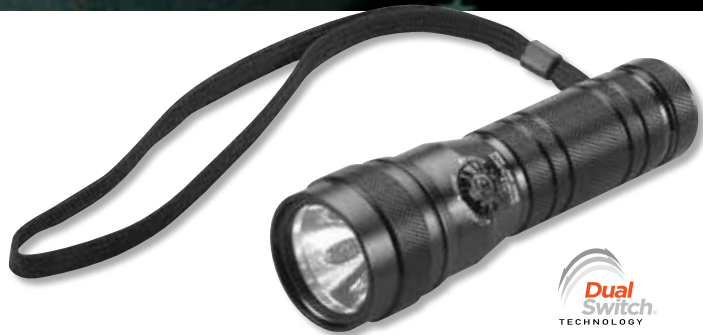

LUMENS:	50
CANDELA:	2,500
DISTANCE:	100m
RUN TIME:	4h 45m

LASER OUTPUT: Useable laser range of 100+ feet when in LED/laser mode, and 100+ yards when in laser only mode.

White LED + UV LEDs: 4 Hours of continuous run time
White LED + Laser: 4 Hours of continuous run time
UV LEDs: 10 Hours of continuous run time
Laser only: 40 Hours of continuous run time

SPECIALIZED TECHNOLOGY FOR SPECIALIZED JOBS.

NIGHT COM® LED

Choose from 3 lighting options: power LED for extreme brightness, night vision protection that meets or exceeds MIL-1472D, or ultra-bright red for use when night vision preservation is not needed. Unbreakable lens. O-ring sealed for weather resistance. Drop-tested.

NIGHT COM LED

BATTERY: [2] 3V "CR123A" lithium

SIZE: 5.43" x 1.33" x .98"
(13.79 x 3.38 x 2.49 cm)

WEIGHT: 5.44 oz (152 g)

COLOR: Matte Black

51056 with lithium batteries. Red LEDs. Matte Black.



Three Modes:



1 INDICATOR LED	2 RED LEDs	POWER LED
Run Time 130 hours	Run Time 28 hours	Run Time 3.5 hours

	WHITE LED	RED LED
LUMENS:	105	2.5
CANDELA:	4,500	—
RUN TIME:	3h 30m	28h

LED - Indicator Type: Preserves complete dark adaptation per MIL-1472D (<0.05 lumens)

NIGHT COM® UV

Choose a far-reaching, bright, white light or an ultraviolet light for detection of fraudulent documents and detecting engine/HVAC leaks. Unbreakable lens. IPX4 rated for water-resistance. 1 meter impact-resistance tested.

NIGHT COM UV

BATTERY: [2] 3V "CR123A" lithium

SIZE: 5.40" x 1.33" x .98"
(13.7 x 3.39 x 2.49 cm)

WEIGHT: 5.44 oz (152 g)

COLOR: Matte Black

51046 with lithium batteries. Matte Black.



Three Modes:



HIGH LED	LOW LED	6 UV LEDs
50,000 hour lifetime	50,000 hour lifetime	(3) 365nm UV LEDs (3) 390nm UV LEDs

	HIGH LED	LOW LED
LUMENS:	115	50
CANDELA:	4,200	1,600
DISTANCE:	130m	80m
RUN TIME:	4h 15m	13h 30m

UV LEDs: 10 Hours of continuous run time



STREAMLIGHT JR. F-STOP®

Ultra-compact lightweight 2AA flashlight features a power LED and Spot to Flood technology! This feature makes the light very versatile for every lighting need. With the bezel forward (for Spot mode) the light has a piercing beam. When the bezel is slid backwards, the beam opens up into a smooth flood pattern for area lighting.

STREAMLIGHT JR. F-STOP

BATTERY: Two (2) "AA" size, Alkaline or Lithium batteries.

SIZE: 6.5" x 1.12" x .75"
(16.51 x 2.84 x 1.90 cm)

WEIGHT: 4.4 oz (125 g)

COLOR: Black, Red or Blue

71700	Black, includes holster and (2) alkaline batteries—clam
71701	Black, includes holster and (2) alkaline batteries—box
71702	Red, includes holster and (2) alkaline batteries—clam
71703	Red, includes holster and (2) alkaline batteries—box
71704	Blue, includes holster and (2) alkaline batteries—clam
71705	Blue, includes holster and (2) alkaline batteries—box

ACCESSORIES

71503	Nylon Holster
99075	Rubber helmet strap



	SPOT	FLOOD
LUMENS:	220	250
CANDELA:	5,600	360
DISTANCE:	150m	38m
RUN TIME:	6h	6h

With the bezel forward (for Spot mode) the light has a piercing beam. When the bezel is slid backwards, the beam opens up into a smooth flood pattern for area lighting.

THE LIGHT SEEN IN EVERY TOOL BOX, IS THE LIGHT THAT CAN HELP YOU SEE ANYWHERE.

STREAMLIGHT JR.® LED

Cutting edge technology makes this lightweight flashlight super-bright and super-convenient. Unbreakable lens. Regulated light output throughout battery life. IPX4 rated for water-resistance. All openings are O-ring sealed. 1 meter impact-resistance tested.

STREAMLIGHT JR. LED

BATTERY: [2] "AA" alkaline or lithium

SIZE: 6.5" x 1.00" x .73"
(16.51 x 2.54 x 1.85 cm)

WEIGHT: 4.1 oz (117 g)

COLOR: Black

71500 with alkaline batteries. Black.

ACCESSORIES

71503 Nylon Holster

71510 Magnetic Clip Holder

99075 Rubber Helmet Strap

LUMENS:	225
CANDELA:	2,700
DISTANCE:	104m
RUN TIME:	6h



STREAMLIGHT JR.® REACH LED

With its flexible cable and magnetic clip, you can put this handy light anywhere and see anything. Unbreakable lens. IPX4 rated for water-resistance. All openings O-ring sealed. 1 meter impact-resistance tested.

STREAMLIGHT JR. REACH LED

BATTERY: [2] "AA" alkaline

SIZE: 20" x .8" x .73"
(50.8 x 2.03 x 1.85 cm)

WEIGHT: 6.1 oz (173 g)

COLOR: Black

LUMENS:	115
CANDELA:	1,500
DISTANCE:	77m
RUN TIME:	7h 30m



71600 with alkaline batteries. Black.

ACCESSORIES

71510 Magnetic Clip Holder



CLIPMATE® USB

This multi-function light clips to pocket or cap for hands-free use. Recharges by plugging into USB port or optional AC wall adaptor. IPX4 water-resistant. 1 meter impact-resistance tested.

CLIPMATE USB

BATTERY: Lithium polymer cell
SIZE: 3.20" x 1.39" x .65" (81 x 35 x 17 mm)
WEIGHT: 1.9 oz (53.8 g)
COLOR: Black

61125 Light only, Black.
 61126 Light with 120V AC, Black.

ACCESSORIES

22070 USB Cord
 22058 120V AC Wall Adapter
 61128 Clipmate USB Battery

WHITE LED	HIGH	LOW	RED LED	HIGH	LOW
LUMENS:	70	10	LUMENS:	.5	.2
CANDELA:	500	50	CANDELA:	9	3
DISTANCE:	44m	14m	DISTANCE:	6m	3m
RUN TIME:	3h 30m	24h	RUN TIME:	16h	65h



Dual LEDs:
 High-intensity white LED
 Night vision red LED



Flexible, extension cable targets the beam where you need it



SURE, THEY'RE CALLED POCKET LIGHTS

BUT REALLY THEY'RE GO-ANYWHERE, DO-ANYTHING LIGHTS.

KEYMATE® USB

This weather resistant, personal area light featuring a recessed button to prevent accidental turn on, a Lithium Polymer rechargeable battery and a low battery power warning indicator. It also includes a snap hook for attachment to a key ring, zipper pull, or ball cap.

KEYMATE USB

BATTERY: Lithium polymer cell

SIZE: 2.9" x 1.08" x .5" (7.3 x 2.74 x 1.27 cm)

WEIGHT: .5 OZ (14.2 g)

COLOR: Black

73200 Keymate USB w/5" (12.7cm) USB Cord—Black



Bright white COB LED provides 35 lumens with optimal area illumination

WHITE LED	HIGH	LOW
LUMENS:	35	16
RUN TIME:	1h	2h

2 hours on Flash mode

Easily charge from your computer, USB port or EPU-5200 with the included USB cable.

CLIPMATE®

Equipped with three high-intensity LEDs and an innovative 360° rotating head, this is one versatile little light. Includes integrated hat clip, elastic strap headband and lanyard.

CLIPMATE

BATTERY: [3] "AAA" alkaline

SIZE: 3.52" x .85" (8.94 x 2.16 cm)

WEIGHT: 2.4 OZ (66.7 g)

COLOR: Yellow with three white LEDs;
Black with a choice of white or green LEDs



LUMENS:	27 (white)
RUN TIME:	40h

61100 Yellow with White LEDs and alkaline batteries

61101 Black with White LEDs and alkaline batteries

61102 Black with Green LEDs and alkaline batteries

THE LOGO®

Weighs less than half an ounce and has 3 light levels plus a blink mode that will flash for 45 hours. To conserve battery, it automatically turns off after 6 minutes in high, medium or low modes. Weather-resistant. 1 meter impact-resistance tested.

THE LOGO

BATTERY: [2] 3V CR2016 lithium coin cell

SIZE: 1.8" x 1.2" x .37" (45.7 x 30.5 x 9.4 mm)

WEIGHT: .37 OZ (10.7 g)

COLOR: Black

73100 The Logo—Black



WHITE LED	HIGH	MEDIUM	LOW
LUMENS:	10	5	2.5

45 hours on Blink mode

STREAMLIGHT LIGHTS FOR A CAUSE

SUPPORTING THE THINGS THAT MATTER TO YOU.

NANO LIGHT®

This tiny, weatherproof light has a non-rotating snap hook for easy one-handed operation when attached to a keychain.

NANO

BATTERY: (4) alkaline button cell

SIZE: 1.47" x .51" x .43" (3.73 x 1.3 x 1.09 cm)

WEIGHT: .36 oz (10 g)

COLOR: Black, Blue, Pink, or Red

For each color Nano Light sale, we donate \$1 to the organization associated with that light. Look below for information about each cause.

LUMENS: 10

RUN TIME: 8h



73001 Black with White LED

73002 COPS/Blue with White LED

73003 BCRF/Pink with White LED

73005 NFFF/Red with White LED

61205 4 pack coin cell Nano Light Batteries



By purchasing this product, you are helping to make a difference in the rebuilding of the lives of surviving families and affected co-workers of law enforcement officers killed in the line of duty. In addition to rebuilding lives, C.O.P.S. (Concerns of Police Survivors) provides training to law enforcement agencies on survivor victimization issues and educates the public of the need to support the law enforcement profession and its survivors. For more information, visit www.nationalcops.org.



The Breast Cancer Research Foundation® is an independent 501 (c) (3) not-for-profit organization whose mission is to advance the world's most promising research to eradicate breast cancer in our lifetime. For more information, visit www.bcrfcur.org.



Congress created the National Fallen Firefighters Foundation to lead a nationwide effort to honor America's fallen firefighters. Since 1992, the non-profit foundation has developed and expanded programs that fulfill that mandate. Their mission is to honor and remember America's fallen fire heroes and to provide resources to assist their survivors in rebuilding their lives. For more information, visit www.firehero.org.

VANTAGE®

The solution to firefighters' hands-free lighting needs. Attaches easily to helmets and hard hats, and rotates 360°. Fits snugly against helmet to prevent snags. Includes a bright blue taillight so you can be seen from behind even in heavy smoke. Easy to operate with gloves. Fits both traditional and modern helmets.

VANTAGE

BATTERY: (2) 3V "CR123A" lithium

SIZE: 3.26" x 1.84" x 2.56" (8.28 x 3.73 x 6.5 cm)

WEIGHT: 5.14 oz (145.7 g)

COLOR: Red

LUMENS: 115

CANDELA: 7,000

DISTANCE: 167m

RUN TIME: 6h

NFPA Meets requirements of NFPA 1971-8.6 (2013); 500° heat resistance test

CE Meets applicable European Community Directives



69157 Vantage LED Tactical Helmet Light. Red.

For every red Vantage sold, Streamlight will donate \$3 to the National Fallen Firefighters Foundation.



SIEGE® AA LANTERN

The Siege® AA lantern features one white LED, and two red LEDs (or two blue LEDs on the C.O.P.S. model). There are five output modes and a battery level indicator built into the on/off button. With the outer lantern globe in place, the light will float. Use the lantern with or without the outer globe cover. Remove the outer globe and hang the body upside down by the D ring for large area lighting needs. Battery replacement is a breeze with the center post orienting the battery cover correctly every time.

WHITE LED	HIGH	MEDIUM	LOW
LUMENS:	200	100	50
RUN TIME:	7h	15h 30m	37h

Light output with outer globe removed.

[2] RED LEDs	HIGH	FLASH/SOS MODE
LUMENS:	.7	.7
RUN TIME:	192h	288h

SIEGE AA

BATTERY: (3) "AA" size alkaline
SIZE: 2.37" x 5.44" (6.00 x 13.82 cm)
WEIGHT: 8.8 OZ (249.47 g)
COLOR: Red, Pink or Blue

44953	Siege AA Lantern – Red
44944	Siege AA Lantern – Pink
44949	Siege AA Lantern – Blue

For every red Siege AA sold, Streamlight will donate \$2 to the National Fallen Firefighters Foundation.

For every pink Siege AA sold, Streamlight will donate \$2 to the Breast Cancer Research Foundation.®

For every blue Siege AA sold, Streamlight will donate \$2 to C.O.P.S. - Concerns of Police Survivors.



With **[(RED SOS)]**
 Hold on/off button to activate.



Shown with outer globe removed.



Integrated D-ring allows you to hang the Siege AA for area lighting.

STRION® LED

A powerful value that's perfect for the broadest range of lighting needs. IPX4 rated for water-resistance. Knurled body provides a sure-grip for easy one-handed operation. 2 meter impact-resistance tested.

STRION LED

BATTERY: Lithium-ion with on-board safety control circuit
SIZE: 5.9" x 1.25" x .95" (14.99 x 3.18 x 2.41 cm)
WEIGHT: 5.2 OZ (148 g)
COLOR: Pink

74350 with AC/12V DC – 1 Holder. Pink.

ACCESSORIES

74361 Piggyback Charger

With **[(STROBE)]**
 Double tap switch to activate.



	HIGH	MEDIUM	LOW
LUMENS:	375	175	80
CANDELA:	12,000	6,500	3,200
DISTANCE:	219m	161m	113m
RUN TIME:	2h 30m	4h 45m	9h 30m

For every pink Strion® LED sold, Streamlight will donate \$5 to the Breast Cancer Research Foundation.®



The Breast Cancer Research Foundation® is an independent 501 (c) (3) not-for-profit organization whose mission is to advance the world's most promising research to eradicate breast cancer in our lifetime. For more information, visit www.brcfure.org.



Streamlight, Inc.
30 Eagleville Road
Eagleville, PA U.S.A 19403-3996

streamlight.com // streamlightgear.com
[800] 523-7488 Toll-Free
[800] 220-7007 Fax
[610] 631-0600
[610] 631-0712 Fax



@2018 Streamlight, Inc. ISO 9001:2015 certified 991165 11/18 asi/89871 // **STAY CONNECTED WITH US:**



All rights reserved. Trademarks of companies mentioned herein appear for identification purposes only and are the property of their respective companies.