



The Right Connection®

DPL418

D  
I  
X  
O  
N

DPL  
418

DIXONVALVE.COM  
877.963.4966

Common Excellence • Uncommon Excellence • Uncommon Excellence • Uncommon Excellence

# WARNING

**Before purchasing Dixon® products, you should be aware and make your customers aware of certain warnings. Such warnings are found on page 916 and the inside back cover of the catalog.**

## Table of Contents

### Engineered Fluid Transfer Couplings



Dry disconnect couplers and adapters, safety breakaways, fluid nozzles, API couplers, vapor recovery couplers, pipe caps, drop elbows, swivel joints, railroad unloading assemblies, ADS fluid controls

**A** pgs. 4 - 65

### Hose Coupling Systems



Boss™ ground joint, stems, wing nuts, and clamps, frac fittings, external swage stems, scovill style couplings, tri-clover stems, fixed welded flanges, combination nipples, ferrules

**B** pgs. 66 - 118

### Cam & Groove



Dixon®, Boss-Lock™, EZ Boss-Lock™, EZLink™, swaged-on, phonograph finish, reducing couplers, adapters, gaskets, replacement handles, accessories, Strap-Grip

**C** pgs. 119 - 188

### Industrial Hose Fittings



King™ combination nipples, suction couplings, strainers, foot valves, hose menders, hose barbs and inserts, garden hose fittings, Agri-Lock and Bauer style couplings

**D** pgs. 189 - 261

### Clamps



Worm gear clamps, t-bolt clamps, single and double bolt clamps, spiral clamps, clamp hand tools, single and double ear clamps, band clamps

**E** pgs. 262 - 281

### Pneumatic Fittings



Sand blast couplings, Surelock™ hose ends, Dix-Lock™ Dual-Lock™, Air Chief industrial and automotive male and female fittings, Parker E-z mate industrial couplers, air brake fittings

**F** pgs. 282-360

### Pneumatic Accessories



King™ safety cables, air receiver manifolds, FRL's, blow guns, gauges, thermometers, air tool lubricant, mufflers, vents, manifolds

**G** pgs. 361 - 448

### Hydraulic Fittings



Couplings, food grade couplers, dust caps and plugs, threaded plugs, hose barbs, extension joints, push-loc barbs, blowout prevention safety couplers, wingstyle threaded couplers, connectors, elbows, tees, bolt flanges, pipe and tube clamps

**H** pgs. 449 - 530

### Valves



Ball valves, mini ball valves, industrial wafer ball valves, nozzle valves, butterfly valves, flow control valves, needle valves **I** pgs. 531 - 562

### Sanitary Fittings



Clamp fittings, weld fittings, bevel seat fittings, John Perry, Q-Line and I-line fittings, buttweld fittings, tube OD fittings, hangers, ball valves, butterfly valves, check valves **J** pgs. 563 - 652

### Pipe, Welding and Tube Fittings



NPT threaded pipe fittings, pipe nipples, swage nipples, hammer unions, instrumentation fittings, SAE flare fittings, push to connect fittings **K** pgs. 653 - 730

### Fire Fittings and Accessories



Hose, reels, connections, wrenches, hydrant adapters, swivels, nipples, valves, thermoplastic, nozzles, Storz fittings, LDH hardware **L** pgs. 731 - 843

### Nozzles, Spray Guns and Accessories



Petroleum fuel nozzles, fire nozzles, washdown nozzles and stations, spray guns and accessories, soap nozzles **M** pgs. 844 - 872

### Hose and Tubing



Mill hose, washdown hose, fire hose, racks and reels, garden hoses, PVC tubing, polyurethane tubing, hose cutters, spiral hose **N** pgs. 873 - 900

### Maintenance and Repair



Thread tape and sealant, hydrostatic test pumps, spill kits, grease whip hose assemblies and fittings, oxy-acetylene fittings, torque wrenches **O** pgs. 901 - 914

### Safety and Technical



Dixon® hose coupling workshop, SOS van, safety information, corrosion resistance of coupling material, thread information, flange dimensions, conversion charts **P** pgs. 915 - 948

## A - Engineered Fluid Transfer Couplings



Adapter weather protector  
page 12



FloTech™ FT590 series rack monitor testers  
page 32



Vapor recovery repair kits  
page 34



Dixon® loading arms  
page 54



Split flange swivel components  
page 55



ADS outalarms, washout caps, cable junction box  
pages 61, 63

## B - Hose Coupling Systems



Suction service fittings  
page 79



125# flange, port adapter, hammer  
union elbows  
page 83



King Crimp™ Female I-line  
page 104



King Crimp™ style FJIC nipple  
page 115

## C - Cam & Groove



Abrasion inserts  
page 131, 134



Global ANSI flange  
page 182

---

## H - Hydraulic Fittings



HTZ series  
page 478

---

## J - Sanitary Fittings



Hex hanger with high temperature sleeve  
page 623



B5115 series butterfly valve  
page 636

---

## L - Fire Fittings and Accessories



Storz hydrant conversion adapter  
page 797



Grooved angle valve  
page 822



Piston intake valve  
page 843

---

## M - Nozzles, Spray Guns and Accessories



Lite washdown spray nozzles  
page 858

Dry Disconnects.....	6 to 16
Bayloc™ style.....	6 to 8
Coupler x female NPT.....	6
Greaseless coupler x female NPT.....	6
Coupler x 90° swivel female NPT.....	6
Coupler locking kit.....	6
Adapter x female NPT.....	7
Jump size adapter x female NPT.....	7
Adapter x 150# ASA flange.....	7
Vapor adapter x female NPSM.....	8
Cam & groove actuator style couplers.....	8
Bayonet style.....	9
90° swivel coupler x female NPT.....	9
Straight coupler x female NPT.....	9
Straight swivel coupler x female NPT.....	9
Dust plugs.....	9
Adapter x female NPT.....	9
Dust caps.....	9
Mann Tek style.....	10-18
Coupler hose unit x female NPT.....	11
Coupler x 150# ASA flange.....	11
Coupler x TTMA flange.....	11
Dust plugs.....	11
Adapter tank unit x female NPT.....	12
Adapter tank unit x 150# flange.....	12
Adapter tank unit x TTMA flange.....	12
Adapter weather protector with clamp.....	12
Dust caps.....	12
Steam coupler x female NPT.....	13
Steam adapter x female NPT.....	13
Dry gas couplings.....	14
Coupler hose unit x female NPT.....	14
Dust plugs.....	14
Adapter tank unit x female NPT.....	14
Adapter tank unit x female ACME.....	14
Adapter tank unit x 150# ASA flange.....	14
Dust caps.....	14
Dry aviation couplings.....	15 to 16
Coupler x female NPT.....	15
Coupler x female BSP.....	15
Dust plug.....	15
Adapter x female NPT.....	16
Adapter x 150# ASA flange.....	16
Dust cap.....	16
Safety Break-aways.....	17 to 18
Marine series.....	17
Female NPT coupling.....	17
Male NPT coupling.....	17
150# flange.....	17
Industrial series.....	18
Female NPT coupling.....	18
Male NPT coupling.....	18
150# flange coupling.....	18
TTMA flanged.....	18

FloMAX Refueling.....	19 to 27
Diesel series.....	19 to 21
Nozzles.....	19
Receiver, one-piece body.....	19
Receiver, two-piece body.....	19
Non-interchange nozzles and receivers.....	20
2" nozzles and receivers.....	20
Gravity fill receivers.....	21
Fuel vents.....	21
Fuel swivels.....	21
Service box.....	21
Standard series connectors.....	22 to 23
Engine oil nozzles and receivers.....	22
Coolant fluid nozzles and receivers.....	22
Hydraulic oil nozzles and receivers.....	23
Transmission nozzles and receivers.....	23
R series.....	24 to 25
Engine oil nozzles and receivers.....	24
Coolant fluid nozzles and receivers.....	24
Hydraulic oil nozzles and receivers.....	25
Transmission fluid nozzles and receivers.....	25
High flow series.....	26
¾" nozzles.....	26
1" nozzles and receivers.....	26
Part number cross reference.....	27

Tank Truck Fittings.....	28 to 48
API.....	28
API couplers.....	28
With bonded nose seal.....	28
With replaceable nose seal.....	28
Locking handle repair kit.....	28
API valves.....	28
Load / unload.....	28
API drop adapters.....	29
With sight glass.....	29
Gravity drop adapters.....	29
Repair kits.....	29
API Dust caps.....	29
Gravity drop adapter dust caps.....	30
Dixon Bayco adapters and couplers with grounding tab.....	30
API compatible rack cords.....	31
Optic assemblies.....	31
Thermistor assemblies.....	31
Replacement parts.....	31
Part number interchange.....	32
FloTech™ series rack monitor testers.....	32
Dixon® vapor recovery couplers.....	33 to 34
With probe x adapter.....	33
With probe x coupler with probe.....	33
Coupler with probe x hose shank.....	33
Coupler x 45° hose shank.....	34
With probe coupler x female NPT.....	34
Flanged tee.....	35

<b>Tank Truck Fittings (cont.)... 28 to 48</b>	<b>Tank Truck Fittings (cont.)... 28 to 48</b>
TTMA..... 35	Caps ..... 47 to 48
Flanged adapters..... 35	Vapor caps..... 47
Flange x male NPT ..... 35	Automatic pressure / vacuum relief caps ..... 47
Flange x extended length male NPT..... 35	Standard stationary vent caps ..... 48
Flange x female NPT ..... 35	Fuel delivery adapter cap..... 48
Slip-on plate flange ..... 35	
Slip-on socket weld flange ..... 35	<b>Swivels ..... 49 to 55</b>
Buttweld flange ..... 35	Swivel joint overview ..... 49
Flange extension with port..... 36	Single plane styles 20, 30 ..... 50
Flange extensions ..... 36	Double plane styles 40, 50, 60..... 50, 51
Cam and groove ..... 36	Triple plane styles 10, 70, 80..... 51
Adapter x TTMA flange ..... 36	Ordering Information ..... 52
Coupler x TTMA flange..... 36	Loading arm swivels..... 53
22½° adapter x TTMA flange ..... 36	Loading arm..... 54
22½° coupler x TTMA flange ..... 36	Split flange ..... 55
Flange gaskets ..... 37	Split flange components..... 55
Sight flow indicators..... 37 to 38, 60	
TTMA flanged sight flow indicators ..... 37, 38	<b>Railroad tank car connections ... 56 to 59</b>
Repair kits ..... 38	Style A..... 56
Flange screen ..... 38	Style F..... 56
Betts Wet-R-Dri™ manual & metering butterfly valves..... 39	Style GF ..... 56
Tank Transport Equipment ..... 40 to 41	Screen..... 56
Fusible pipe caps ..... 40	Style S..... 56
Pipe caps ..... 40	Style T..... 57
Reducers..... 40	Dixon® coupler x tank car thread..... 57
Reducing cap ..... 40	EZ Boss-Lock™ x coupler tank car thread ..... 57
Coupling gaskets ..... 40	Railroad unloading assemblies..... 58
Pipe caps ..... 41	Dixon® tank car adapters ..... 58
Thread adapters..... 41	Cam and groove railroad tank car gaskets..... 59
Cam and groove adapter ..... 41	Pin lug wrench ..... 59
6200 series side lever type drop elbows ..... 42	
6500 series self-locking drop elbows..... 42	<b>ADS ..... 61 to 65</b>
Inlets ..... 42	Outalarms ..... 61 to 63
Male adapter ..... 42	With capacitance probes..... 61
Female coupler ..... 42	With high temperature capacitance probes ..... 61
Female NPT..... 42	Outage gauge..... 62
Dual point vapor recovery elbows, ball lever ..... 43	Gauge rods..... 62
Adapter inlet..... 43	
Single point coaxial drop elbow ..... 43	<b>Spillguard™ ..... 63 to 65</b>
Adapter fuel inlets ..... 43	Cables ..... 63
Coupler fuel inlets ..... 43	Accessories ..... 63
Tight fill ..... 44	Monitors..... 64
Elbows, complete unit..... 44	Probes ..... 65
Elbow coupler body..... 44	Capacitance ..... 65
Male adapter inlet end ..... 44	Conductivity ..... 65
Side seal drop elbow ..... 44	Float..... 65
Side seal to top seal adapter ..... 44	Multi-point ultrasonic ..... 65
Dust caps and plugs with pull handle ..... 45	
Reelcraft® static discharge reel..... 45	
TFA series fill pipe adapter..... 46	
Fuel delivery tank adapters ..... 46	
Vapor recovery tank adapters ..... 46	

Bayloc™ Dry Disconnects

Coupler x Female NPT

**A**  
 Engineered Fluid  
 Transfer Couplings  
**A**

**Features:**

- automatic closing poppet assembly
- must be used with a DBA style adapter for coupler to operate, sold separately
- fully interchangeable with Kamvalok (OPW trademark) fittings
- maximum operating pressure at 70°F (21°C):
  - 1½" - 210 PSI
  - 2" - 150 PSI
  - 3" - 120 PSI
- aluminum fittings have stainless internals equivalent to 304 stainless
- stainless handle allows exposure to corrosive chemicals or wash down service
- heavy duty handle attachment prevents bending of crank assembly
- one piece stainless crank and link provide long service life
- EZ Boss-Lock™ cam arms, standard on all 1½" and 2" fittings, provide high security from accidental opening due to vibration or snagging
- large paddle type locking cam arms, standard on 3" fittings, allow for an easy grip
- optional coupler lock for handle to prevent unintentional opening

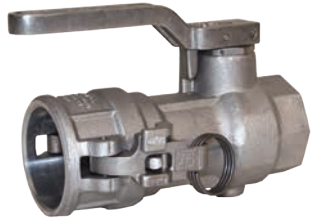

coupler x 1½" or 2" female NPT



coupler x 3" female NPT

Female NPT	Coupler Size	Seal Material	Maximum PSI at 70°F (21°C)	Aluminum Part #	Stainless Steel <sup>1</sup> Part #
1½"	2"	Buna	210	DBC61-150	DBC71-150
2"	2½"		150	DBC61-200	DBC71-200
3"	4"		120	DBC61-300	DBC71-300
1½"	2"	FKM	210	DBC62-150	DBC72-150
2"	2½"		150	DBC62-200	DBC72-200
3"	4"		120	DBC62-300	DBC72-300
1½"	2"	PTFE Encapsulated Silicone & FFKM	210	DBC63-150	DBC73-150
2"	2½"		150	DBC63-200	DBC73-200
3"	4"		120	DBC63-300	DBC73-300
1½"	2"	EPDM	210	DBC64-150	DBC74-150
2"	2½"		150	DBC64-200	DBC74-200
3"	4"		120	DBC64-300	DBC74-300
1½"	2"	FFPM and PTFE <sup>2</sup>	210	---	DBC76-150
2"	2½"		150	DBC66-200	DBC76-200
3"	4"		120	DBC66-300	DBC76-300
1½"	2"	PTFE Encapsulated FKM & FFKM	210	---	DBC77-150
2"	2½"		150	---	DBC77-200
3"	4"		120	---	DBC77-300
3"	4"	FKM-B	120	DBC69-300	DBC79-300

**Greaseless Coupler x Female NPT**



Female NPT	Coupler Size	Seal Material	Stainless Steel <sup>1</sup> Part #
1½"	2"	PTFE Encapsulated FKM & FFKM	DBC77-150-GL
2"	2½"		DBC77-200-GL

<sup>1</sup> stainless steel corrosion resistance is equivalent to 304 stainless steel

<sup>2</sup> FFKM gasket, main seal O-ring and handle O-ring, PTFE seals on cylinder assembly, stuffing box, and seal under poppet screw

**Coupler x 90° Swivel Female NPT**

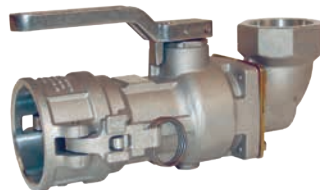

Female NPT	Coupler Size	Seal Material	Aluminum Part #
2"	2½"	Buna FKM	DBS61-200
2"	2½"		DBS62-200
2"	2½"	PTFE Encapsulated Silicone & FFKM	DBS63-200

**Coupler Locking Kits**



Description	Aluminum Part #
for use with 1½" and 2" dry disconnect couplers	DBCL-200
for use with 3" dry disconnect couplers	DBCL-300

Note: Reference page 179 for dust plugs for couplers.



## Bayloc™ Dry Disconnects

### Adapter x Female NPT

**Applications:**

- compatible with most cam and groove style dry disconnects
- helps prevent spillage from normal or accidental disconnects
- for use in transfer of hazardous fluids

**Features:**

- two-piece adapter design for easy rebuilding of adapters
- fully interchangeable with Kamvalok (OPW trademark) style fittings
- for pressure ratings at other temperatures, contact Dixon®
- contact Dixon® at 800.355.1991 for chemical compatibility, size, material selection and special configurations
- spring loaded sealing device snaps closed should valve become disconnected with the poppet open

Female NPT	Adapter Size	Seal Material	Maximum PSI at 70°F (21°C)	Aluminum Part #	Stainless Steel Part #
1½"	2"	<i>Buna</i>	<b>210</b>	<b>DBA11-150</b>	<b>DBA71-150</b>
2"	2½"		<b>150</b>	<b>DBA11-200</b>	<b>DBA71-200</b>
3"	4"		<b>120</b>	<b>DBA11-300</b>	<b>DBA71-300</b>
1½"	2"	<i>FKM</i>	<b>210</b>	<b>DBA12-150</b>	<b>DBA72-150</b>
2"	2½"		<b>150</b>	<b>DBA12-200</b>	<b>DBA72-200</b>
3"	4"		<b>120</b>	<b>DBA12-300</b>	<b>DBA72-300</b>
1½"	2"	<i>PTFE Encapsulated Silicone</i>	<b>210</b>	<b>DBA63-150</b>	<b>DBA73-150</b>
2"	2½"		<b>150</b>	<b>DBA63-200</b>	<b>DBA73-200</b>
3"	4"		<b>120</b>	<b>DBA63-300</b>	<b>DBA73-300</b>
1½"	2"	<i>EPDM</i>	<b>210</b>	<b>DBA64-150</b>	<b>DBA74-150</b>
2"	2½"		<b>150</b>	<b>DBA64-200</b>	<b>DBA74-200</b>
3"	4"		<b>120</b>	<b>DBA64-300</b>	<b>DBA74-300</b>
1½"	2"	<i>FFPM</i>	<b>210</b>	<b>DBA66-150</b>	<b>DBA76-150</b>
2"	2½"		<b>150</b>	<b>DBA66-200</b>	<b>DBA76-200</b>
3"	4"		<b>120</b>	<b>DBA66-300</b>	<b>DBA76-300</b>
1½"	2"	<i>PTFE Encapsulated FKM</i>	<b>210</b>	---	<b>DBA77-150</b>
2"	2½"		<b>150</b>	---	<b>DBA77-200</b>
3"	4"		<b>120</b>	---	<b>DBA77-300</b>
3"	4"	<i>FKM-B</i>	<b>120</b>	<b>DBA69-300</b>	---



adapter x 1½" and 2" female NPT



adapter x 3" female NPT

### Jump Size Adapter x Female NPT

Female NPT	Adapter Size	Seal Material	Maximum PSI at 70°F (21°C)	Aluminum Part #
2"	2"	<i>Buna</i>	<b>150</b>	<b>DBA11-1520</b>
2"	2"	<i>FKM</i>	<b>150</b>	<b>DBA12-1520</b>



### Adapter x 150# ASA Flange

Flange Size	Adapter Size	Seal Material	Maximum PSI at 70°F (21°C)	Stainless Steel Part #
2"	2"	<i>FKM</i>	<b>150</b>	<b>DBAF72-1520</b>
		<i>PTFE Encapsulated Silicone</i>		<b>DBAF73-1520</b>
		<i>EPDM</i>		<b>DBAF74-1520</b>
		<i>FFPM</i>		<b>DBAF76-1520</b>
2"	2½"	<i>FKM</i>	<b>150</b>	<b>DBAF72-200</b>
		<i>PTFE Encapsulated Silicone</i>		<b>DBAF73-200</b>
		<i>EPDM</i>		<b>DBAF74-200</b>
		<i>FFPM</i>		<b>DBAF76-200</b>
3"	4"	<i>FKM</i>	<b>150</b>	<b>DBAF72-300</b>
		<i>PTFE Encapsulated Silicone</i>		<b>DBAF73-300</b>
		<i>EPDM</i>		<b>DBAF74-300</b>
		<i>FFPM</i>		<b>DBAF76-300</b>

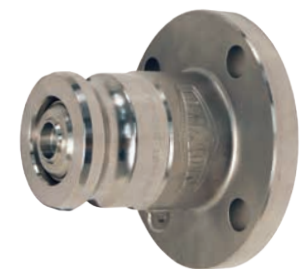

Note: Reference page 179 for dust caps for adapters

- For flange dimensions, diagrams and additional information please reference [dixonvalve.com](http://dixonvalve.com).

## Bayloc™ Dry Disconnect Vapor Adapter x Female NPSM



Female NPSM	Adapter Size	Seal	Max PSI at 70°F (21°C)	Stainless Steel <sup>1</sup> Part #
1½"	2"	PTFE	150	<b>DBAV73-2030</b>

<sup>1</sup> stainless steel corrosion resistance is equivalent to 304 stainless steel

Note: Reference page 179 for dust caps for adapters

## Cam &amp; Groove Actuator Style Couplers

**Applications:**

- suited for vapor recovery, suction pump line and other applications where it is necessary to easily drain the hose or pipe for cleaning
- can also be used when product retention in a hose or pipe is desired and damage from accidental spill from an open coupler is not a concern
- couplers work with the DBA popped adapters on page 7 in applications where automatic closure for the coupler is not desired

**Materials:**

- 316 stainless steel body
- 304 stainless steel internal components
- replacement parts are available, contact Dixon® for more information

**Features:**

- EZ Boss-Lock™ cam arms
- stainless steel locking lever standard
- use with standard cam and groove dust plugs sized one size larger than the dry disconnect size
- prevents spillage from normal and accidental disconnection of the connection



Female NPT	Coupler Size	Seal Material	Stainless Steel Part #
1½"	2"	<i>Buna</i>	<b>D2C71-150</b>
2"	2½"		<b>D2C71-200</b>
1½"	2"	<i>FKM</i>	<b>D2C72-150</b>
2"	2½"		<b>D2C72-200</b>
1½"	2"	<i>PTFE Encapsulated Silicone</i>	<b>D2C73-150</b>
2"	2½"		<b>D2C73-200</b>
1½"	2"	<i>EPDM</i>	<b>D2C74-150</b>
2"	2½"		<b>D2C74-200</b>
1½"	2"	<i>PTFE Encapsulated FKM</i>	<b>D2C77-150</b>
2"	2½"		<b>D2C77-200</b>
1½"	2"	<i>FKM-B</i>	<b>D2C79-150</b>
2"	2½"		<b>D2C79-200</b>

## Bayonet Style Dry Disconnects

**Application:**

- for the spill-less transfer of petroleum products such as fuel oil, lube oil blending and tank truck delivery

**Features:**

- ensures a spill free connection, fluid cannot flow until couplings are connected together and valve is opened; coupling can then not be disconnected until the valve handle is closed
- swivels have a standard ZERK fittings
- maximum operating pressure: **85 PSI @ 70°F (21°C)**, for pressure ratings at other temperatures contact Dixon®
- replacement parts available, contact Dixon® for more information

### 90° Swivel Coupler x Female NPT

Size	Seal Material	Anodized Hard Coat Aluminum Part #
2"	Buna	<b>BS61-200</b>
2"	FKM	<b>BS62-200</b>
3"	Buna	<b>BS61-300</b>
3"	FKM	<b>BS62-300</b>



### Straight Coupler x Female NPT

Size	Seal Material	Anodized Hard Coat Aluminum Part #
2"	Buna	<b>BC61-200</b>
2"	FKM	<b>BC62-200</b>



### Straight Swivel Coupler x Female NPT

Size	Seal Material	Anodized Hard Coat Aluminum Part #
2"	Buna	<b>BSS61-200</b>
2"	FKM	<b>BSS62-200</b>
3"	Buna	<b>BSS61-300</b>
3"	FKM	<b>BSS62-300</b>



### Dust Plugs

Size	Rubber with Stainless Steel Chain Part #
2"	<b>BCP-200</b>
3"	<b>BCP-300</b>



### Adapter x Female NPT

Size	Seal Material	Stainless Steel Part #	Brass Part #	Aluminum Part #
2"	Buna	<b>BA31-200</b>	---	---
2"	FKM	<b>BA32-200</b>	---	---
3"	Buna	---	<b>BA31-300</b>	<b>BA61-300</b>
3"	FKM	---	<b>BA32-300</b>	<b>BA62-300</b>



### Dust Caps

Size	Rubber with Stainless Steel Chain Part #
2"	<b>BAC-200</b>
3"	<b>BAC-300</b>



## MannTek Dry Disconnect Couplings

### Applications:

- used by producers of ink, adhesives, fatty acids, pharmaceuticals, liquid soaps, petroleum, chemicals, agricultural and a wide variety of common caustic and specialty acids
- designed for the quick and spill free connection and disconnection of hoses and pipelines

### Features:

- easy to handle - push and turn - free flow, turn and pull - closed
- time saving - no need to drain hoses or pipe systems
- economical - no loss or spillage of liquids at connection or disconnection
- safety - the valve cannot be opened until the unit is coupled
- environmental friendly - accidental spillage eliminated when proper used
- safe and reliable - due to rugged construction
- product life - uncomplicated design and high quality materials ensures long product life
- selectivity - To avoid product contamination, selective versions of the couplers and adapters are available. Contact Dixon® for further information.
- produced according to NATO standard STANAG 3756 and ATOFINA SGM 2049.TUY.C.
- working pressure at ambient temperature **70°F (21°C)**:
  - aluminum: **230 PSI**, up to 4"
  - brass/ gunmetal <sup>1</sup>: **230 PSI**, up to 4"
  - stainless steel: **360 PSI**
- standard seal supplied: FKM
- optional seals:
  - EPDM
  - NBR - nitrile
  - Kalrez®
  - Chemraz®
- seal kits are available
- interchanges with Avery Hardoll and Todo-matic®

<sup>1</sup> produced to US government bronze specification G



## How it Works

The principle of operation is identical for all sizes of couplings.

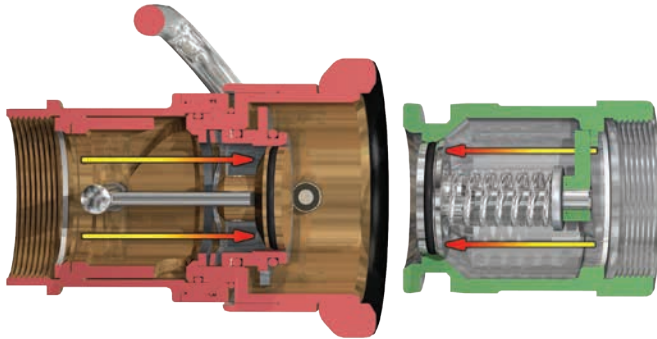

### Closed:

- Turn and pull  
it's released - no spillage

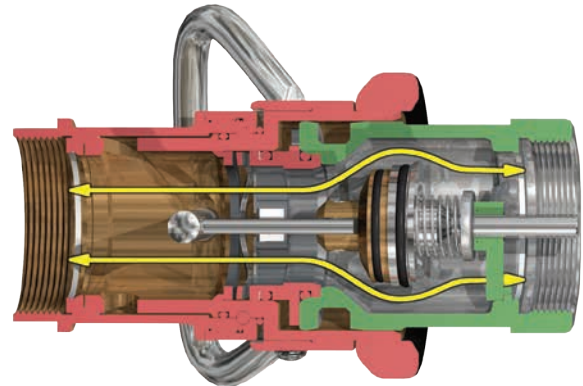

### Open:

- Push and turn  
it's coupled - full flow

## MannTek Dry Disconnect Couplers - Hose Unit

**Features:**

- coupler has built-in swivel
- stainless steel ball bearings
- stainless steel shaft journal embedded in PTFE to eliminate seizure
- riveted piston pin to minimize the risk for failure under extreme pressure conditions
- the protective ring is a specially formulated, weather resistant and electrically conductive rubber compound
- all wetted parts are stainless steel
- stainless steel couplers: rollers are Hastelloy C276 on the stainless steel shaft
- aluminum and brass couplers: rollers are aluminum-bronze on the stainless steel shaft
- composite (Polyeten PE-HD 300) plugs provide good protection against corrosion and withstand hot and cold environments

### Coupler x Female NPT



Female NPT	Body Size	316 Stainless Steel Part #	Aluminum Part #	Brass / Gunmetal <sup>1</sup> Part #
3/4"	56 mm	<b>DDC075SS</b>	<b>DDC075AL</b>	<b>DDC075BR</b>
1"	56 mm	<b>DDC100SS</b>	<b>DDC100AL</b>	<b>DDC100BR</b>
1 1/2"	70 mm	<b>DDC150SS</b>	<b>DDC150AL</b>	<b>DDC150BR</b>
2"	70 mm	<b>DDC200SS</b>	<b>DDC200AL</b>	<b>DDC200BR</b>
3"	105 mm	<b>DDC300SS105</b>	<b>DDC300AL105</b>	<b>DDC300GM105</b>
3"	119 mm	<b>DDC300SS</b>	<b>DDC300AL</b>	<b>DDC300GM</b>
4"	164 mm	<b>DDC400SS</b>	<b>DDC400AL</b>	<b>DDC400GM</b>
6"	238 mm	<b>DDC600SS</b>	<b>DDC600AL</b>	---

<sup>1</sup> produced to US government bronze specification G

### Coupler x 150# ASA Flange

150# Flange	Body Size	316 Stainless Steel Part #
2"	70 mm	<b>DDC200SSFL</b>
3"	119 mm	<b>DDC300SSFL</b>
4"	164 mm	<b>DDC400SSFL</b>
6"	238 mm	<b>DDC600SSFL</b>
8"	272 mm	<b>DDC800SSFL</b>



- For flange dimensions, diagrams and additional information please reference [dixonvalve.com](http://dixonvalve.com).

### Coupler x TTMA Flange

TTMA Flange	Body Size	Aluminum Part #
4"	164 mm	<b>DDC400AL164TTMA</b>



- For flange dimensions, diagrams and additional information please reference [dixonvalve.com](http://dixonvalve.com).

### Dust Plugs

Size	Body Size	Polyeten PE-HD 300 Part #
3/4" and 1"	56 mm	<b>DDDP075</b>
1 1/2" and 2"	70 mm	<b>DDDP150</b>
3"	105 mm	<b>DDDP300105</b>
3"	119 mm	<b>DDDP300</b>
4"	164 mm	<b>DDDP400</b>
6"	238 mm	<b>DDDP600</b> <sup>1</sup>



<sup>1</sup> aluminum

## MannTek Dry Disconnect Adapters - Tank Unit

**Application:**

- usually installed on the tank or manifold

**Features:**

- conical valve seat reduces the risk for piston blow out
- PTFE bearing between piston shaft and guide eliminates risk of seizure
- aluminum adapter: aluminum poppet, stainless steel internal parts
- stainless steel adapter: stainless steel poppet, stainless steel internal parts
- brass / gunmetal <sup>1</sup> adapter: brass poppet, brass and stainless steel internal parts
- composite (Polyeten PE-HD 300) cap to provide good protection in harsh environments
- FKM (FPM) gaskets standard on polyeten caps

**Adapter x Female NPT**

Female NPT	Body Size	316 Stainless Steel Part #	Aluminum Part #	Brass / Gunmetal <sup>1</sup> Part #
¾"	56 mm	<b>DDA075SS</b>	<b>DDA075AL</b>	<b>DDA075BR</b>
1"	56 mm	<b>DDA100SS</b>	<b>DDA100AL</b>	<b>DDA100BR</b>
1½"	70 mm	<b>DDA150SS</b>	<b>DDA150AL</b>	<b>DDA150BR</b>
2"	70 mm	<b>DDA200SS</b>	<b>DDA200AL</b>	<b>DDA200BR</b>
3"	105 mm	<b>DDA300SS105</b>	<b>DDA300AL105</b>	<b>DDA300GM105</b>
3"	119 mm	<b>DDA300SS</b>	<b>DDA300AL</b>	<b>DDA300GM</b>
4"	164 mm	<b>DDA400SS</b>	<b>DDA400AL</b>	<b>DDA400GM</b>
6"	238 mm	<b>DDA600SS</b>	<b>DDA600AL</b>	---

**Adapter x 150# ASA Flange**

150# Flange	Body Size	316 Stainless Steel Part #	Aluminum Part #	Brass / Gunmetal <sup>1</sup> Part #
¾"	56 mm	<b>DDA075SSFL</b>	---	---
1"	56 mm	<b>DDA100SSFL</b>	<b>DDA100ALFL</b>	<b>DDA100BRFL</b>
1½"	70 mm	<b>DDA150SSFL</b>	<b>DDA150ALFL</b>	<b>DDA150BRFL</b>
2"	70 mm	<b>DDA200SSFL</b>	<b>DDA200ALFL</b>	<b>DDA200BRFL</b>
3"	105 mm	<b>DDA300SS105FL</b>	<b>DDA300AL105FL</b>	<b>DDA300GM105FL</b>
3"	119 mm	<b>DDA300SSFL</b>	<b>DDA300ALFL</b>	<b>DDA300GMFL</b>
4"	164 mm	<b>DDA400SSFL</b>	<b>DDA400ALFL</b>	<b>DDA400GMFL</b>
6"	238 mm	<b>DDA600SSFL</b>	<b>DDA600ALFL</b>	---
8"	272 mm	<b>DDA800SSFL</b>	---	---



<sup>1</sup> produced to US government bronze specification G

- For flange dimensions, diagrams and additional information please reference dixonvalve.com.

**Adapter x TTMA Flange**

TTMA Flange	Body Size	Aluminum Part #
3"	105 mm	<b>DDA300AL105TTMA</b>
3"	119 mm	<b>DDA300AL119TTMA</b>
4"	164 mm	<b>DDA400AL164TTMA</b>



- For flange dimensions, diagrams and additional information please reference dixonvalve.com.

**Adapter Weather Protector with Clamp**

Size	Black Neoprene Part #
2"	<b>PCDVCHSS36</b>

**Dust Caps**

Size	Body Size	Polyeten PE-HD 300 Part #
¾" and 1"	56 mm	<b>DDDC075</b>
1½" and 2"	70 mm	<b>DDDC150</b>
3"	105 mm	<b>DDDC300105</b>
3"	119 mm	<b>DDDC300</b>
4"	164 mm	<b>DDDC400</b>
6"	238 mm	<b>DDDC600</b> <sup>1</sup>



<sup>1</sup> 6" dust cap is aluminum

Note: Reference page 14 for rubber dust caps.

## MannTek Dry Disconnects for Steam Service

**Applications:**

- designed to fit hoses carrying steam used in chemical (heating), pharmaceutical (disinfection and sterilization) and at loading bays

**Features:**

- coupling housing and all inner parts: stainless steel
- EPDM 291 seal
- unintentional separation is eliminated preventing accidents and avoiding unintended down time
- performance unaffected by surface rust
- lockable versions are available on 1½" and 2", contact Dixon®
- couplers supplied with double handles
- **150 PSI at 350°F (177°C)**

---

**Coupler x Female NPT**

Female NPT	Body Size	316 Stainless Steel Part #
¾"	56 mm	<b>DDSC075SS</b>
1"	56 mm	<b>DDSC100SS</b>
1½"	70 mm	<b>DDSC150SS</b>
2"	70 mm	<b>DDSC200SS</b>



---

**Adapter x Female NPT**

Female NPT	Body Size	316 Stainless Steel Part #
¾"	56 mm	<b>DDSA075SS</b>
1"	56 mm	<b>DDSA100SS</b>
1½"	70 mm	<b>DDSA150SS</b>
2"	70 mm	<b>DDSA200SS</b>



## MannTek Dry Gas Couplings

**Applications:**

- primary application is in the handling of LPG - Propane and Butane
- designed for loading and discharge of bobtails or intermediate bulk delivery trucks to and from rail cars

**Features:**

- reliable, easy to maintain
- can be coupled to a tank unit with pressures up to **225 PSI** at ambient temperature **70°F (21°C)**, if pressure is higher, equip couplings with pressure relief valves.
- minimizes the risk of cold burns, spillage, product loss and health risks and keeps the environment free of hazardous vapors and liquids
- compatible with existing dry disconnect couplings
- stainless steel and brass / gunmetal (*produced to US government bronze specification G*)
- FKM (FPM) seals
- working pressure: **360 PSI** at ambient temperature **70°F (21°C)**
- composite (Polyeten PE-HD 300) plug provides good protection in harsh environments
- for pressure relief options contact Dixon®

**Coupler x Female NPT**

Female NPT	Body Size	316 Stainless Steel Part #
1"	56 mm	<b>DGC100SS</b>
2"	71 mm	<b>DGC200SS</b>
3"	119 mm	<b>DGC300SS</b>

**Dust Plug for Couplers**

Size	Body Size	Polyeten PE-HD 300 Part #
1"	56 mm	<b>DGDP100</b>
2"	71 mm	<b>DGDP200</b>
3"	119 mm	<b>DGDP300</b>

**Adapter x Female NPT**

Female NPT	Body Size	316 Stainless Steel Part #
1"	56 mm	<b>DGA100SS</b>
2"	71 mm	<b>DGA200SS</b>
3"	119 mm	<b>DGA300SS</b>

**Adapter x Female ACME**

Female ACME	Body Size	316 Stainless Steel Part #
1¾"	56 mm	<b>DGA100SS175</b>
3¼"	71 mm	<b>DGA200SS325</b>

**Adapter-Tank Unit x 150# ASA Flange**

150# Flange	Body Size	316 Stainless Steel Part #
1"	56 mm	<b>DGA100SSFL</b>
2"	71 mm	<b>DGA200SSFL</b>
3"	119 mm	<b>DGA300SSFL</b>

- For flange dimensions, diagrams and additional information please reference [dixonvalve.com](http://dixonvalve.com).

**Dust Cap for Adapters**

Size	Body Size	Material	Part #
1"	56 mm	<i>polyeten PE-HD300</i>	<b>DGDC100</b>
2"	71 mm	<i>rubber</i>	<b>DGDC200</b>
3"	119 mm	<i>rubber</i>	<b>DGDC300</b>



## MannTek Dry Aviation Couplers - Hose Unit

**Application:**

- designed for use in aviation refueling systems

**Features:**

- working pressure: **150 PSI** at ambient temperature **70°F (21°C)**
- composite (Polyeten PE-HD 300) plug provides good protection in harsh environments
- accepts international standard 2½" point bayonet, hose end refueling nozzles according to: ISO45 / MS24484 / STANAG 3105 / British Aerospace Spec. 2C14, **they are not configured for under-wing refueling** 
- gunmetal coupling ring minimizes the risk of seizure
- riveted piston pin minimizes risk of failure under extreme pressure conditions
- protective ring is a specially formulated, weather resistant and electrically conductive rubber compound

**Materials:**

- body: high strength aluminum
- coupling ring: gunmetal (*produced to U.S. government bronze specification G*)
- bayonet flange and inner parts: stainless steel, aluminum
- all wetted parts are aluminum and stainless steel
- stainless steel ball bearings
- stainless steel shaft journal embedded in PTFE eliminates seizure
- PTFE bearings between the driving plate and piston guide eliminate the risk of seizure

**Coupler x Female NPT**

Female NPT	Body Size	Aluminum Part #
2½"	ISO 45	<b>DAC250AL</b>
3"	ISO 45	<b>DAC300AL</b>

**Coupler x Female BSP**

Female BSP	Body Size	Aluminum Part #
2½"	ISO 45	<b>DAC250ALBSP</b>
3"	ISO 45	<b>DAC300ALBSP</b>



**Dust Plug for Couplers**

Size	Body Size	Polyeten PE-HD300 Part #
2½"	ISO 45	<b>DADP250</b>



## MannTek Dry Aviation Adapters - Tank Unit

**Application:**

- designed for use in aviation refueling systems

**Materials:**

- body: high strength aluminum
- coupling ring: gunmetal
- bayonet flange and inner parts: stainless steel, aluminum
- all wetted parts are in aluminum and stainless steel

**Features:**

- working pressure: **150 PSI** at ambient temperature **70°F (21°C)**
- composite (Polyeten PE-HD 300) cap provides good protection in harsh environments
- accepts international standard 2½" point bayonet hose end refueling nozzles according to: ISO45 / MS24484 / STANAG 3105 / British Aerospace Spec. 2C14, **not configured for under-wing refueling** 
- gunmetal coupling ring minimizes the risk of seizure
- PTFE bearings between the piston shaft and the piston guide eliminate the risk of seizure
- conical valve seat eliminates the risk of piston blow out when extreme pressure is used

**Adapter x Female NPT**

Size	Body Size	Aluminum Part #
2½"	ISO 45	<b>DAA250AL</b>
3"	ISO 45	<b>DAA300AL</b>

**Adapter x 150# ASA Flange**

150# Flange	Body Size	Aluminum Part #
2½"	ISO 45	<b>DAA250ALFL</b>
3"	ISO 45	<b>DAA300ALFL</b>

- For flange dimensions, diagrams and additional information please reference [dixonvalve.com](http://dixonvalve.com).

**Dust Cap for Adapters**

Size	Body Size	Polyeten PE-HD 300 Part #
2½"	ISO 45	<b>DADC250</b>

## MannTek Safety Break-away Couplings - Marine Version

**Application:**

- typically for ship-to-offshore platform and ship-to-ship product transfer operations

**Features:**

- **designed to be installed within a hose string where the coupling will have a length of hose attached to both sides**
- minimizes spillage and damage associated with pull-away incidents
- coupling automatically senses excessive load, closes the valves and disconnects, release is executed when force causes bolts to break
- working pressure: **360 PSI** at ambient temperature **70°F (21°C)**
- FKM (FPM) O-rings, additional seal materials are available
- optional non-closure design available, contact Dixon®



### Female NPT x Female NPT

Size	DN Size	316 Stainless Steel Part #
2"	50	<b>MSBC200SS</b>
3"	80	<b>MSBC300SS</b>
4"	100	<b>MSBC400SS</b>
5"	125	<b>MSBC500SS</b>
6"	150	<b>MSBC600SS</b> <b>NEW</b>



### Male NPT x Male NPT

Size	DN Size	316 Stainless Steel Part #
2"	50	<b>MSBC200SSMNPT</b>
3"	80	<b>MSBC300SSMNPT</b>
4"	100	<b>MSBC400SSMNPT</b>
5"	125	<b>MSBC500SSMNPT</b>
6"	150	<b>MSBC600SSMNPT</b>



### 150# Flange x 150 Flange

Size	DN Size	316 Stainless Steel Part #
2"	50	<b>MSBC200SSFL</b>
3"	80	<b>MSBC300SSFL</b>
4"	100	<b>MSBC400SSFL</b>
5"	125	<b>MSBC500SSFL</b>
6"	150	<b>MSBC600SSFL</b>
8"	200	<b>MSBC800SSFL</b>



- For flange dimensions, diagrams and additional information please reference [dixonvalve.com](http://dixonvalve.com).

### How it Works

Safety break-away couplings have three external break bolts. In the case of axial tension all of the bolts take up the force corresponding to the break force on the hose with a safety margin. Non-axial forces concentrate the tension forces more strongly on one bolt, so that the safety break-away coupling reacts in a natural way to the reduction of the hose break forces.

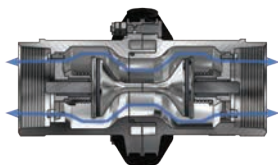

#### BEFORE emergency disconnect

The safety break-away valve consists of two halves, each with a valve that has a O-ring seal.

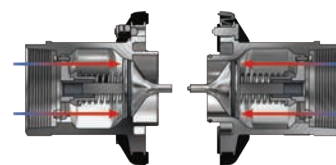

#### AFTER emergency disconnect

When the safety break-away couplings separate, it allows the valves to close. The two valves close rapidly, minimizing exposure to personnel and the environment.

**MannTek Safety Break-away Couplings - Industrial Version**

**Application:**

- loading rack, bulk loading / unloading, road tankers and rail tankers



**Features:**

- designed to be installed between a fixed point (pipe, pump, manifold) and a hose
- minimizes spillage and damage associated with pull-away incidents
- coupling automatically senses excessive load, closes valves and disconnects, release is executed when force causes bolts to break
- high flow rate / low pressure drop
- working pressure: stainless steel **360 PSI** and aluminum **230 PSI** at ambient temperature **70°F (21°C)**
- FKM (FPM) seal standard, additional seal materials are available
- optional non-closure design available, contact Dixon®

**Female NPT x Female NPT**



Size	DN Size	316 Stainless Steel Part #	Aluminum Part #
1"	25	<b>SBC100SS</b>	<b>SBC100AL</b>
2"	50	<b>SBC200SS</b>	<b>SBC200AL</b>
3"	80	<b>SBC300SS</b>	<b>SBC300AL</b>
4"	100	<b>SBC400SS</b>	<b>SBC400AL</b>
5"	125	<b>SBC500SS</b>	<b>SBC500AL</b>
6"	150	<b>SBC600SS</b>	<b>SBC600AL</b>

**Male NPT x Male NPT**



Size	DN Size	316 Stainless Steel Part #	Aluminum Part #
2"	50	<b>SBC200SSMNPT</b>	<b>SBC200ALMNPT</b>
3"	80	<b>SBC300SSMNPT</b>	<b>SBC300ALMNPT</b>
4"	100	<b>SBC400SSMNPT</b>	<b>SBC400ALMNPT</b>
5"	125	<b>SBC500SSMNPT</b>	<b>SBC500ALMNPT</b>
6"	150	<b>SBC600SSMNPT</b>	<b>SBC600ALMNPT</b>

**150# Flange x 150# Flange**



Size	DN Size	316 Stainless Steel Part #	Aluminum Part #
1"	25	<b>SBC100SSFL</b>	---
2"	50	<b>SBC200SSFL</b>	<b>SBC200ALFL</b>
3"	80	<b>SBC300SSFL</b>	<b>SBC300ALFL</b>
4"	100	<b>SBC400SSFL</b>	<b>SBC400ALFL</b>
5"	125	<b>SBC500SSFL</b>	<b>SBC500ALFL</b>
6"	150	<b>SBC600SSFL</b>	<b>SBC600ALFL</b>
8"	200	<b>SBC800SSFL</b>	---

- For flange dimensions, diagrams and additional information please reference [dixonvalve.com](http://dixonvalve.com).

**TTMA Flanged Breakaway Coupling**

**Features:**

- minimizes spillage and damage associated with drive away and pull away incidents
- installs between an API coupler and loading arm
- coupling automatically senses excessive load, closes the valves and disconnects, release is executed when force causes the bolts to break
- high flow rate / low pressure drop
- **150 PSI** at ambient temperature **70°F (21°C)**
- FKM/FPM is standard seal



Size	Aluminum Part #
4"	<b>SBC400ALTTMA</b>

- For flange dimensions, diagrams and additional information please reference [dixonvalve.com](http://dixonvalve.com).

## FloMAX Diesel Fueling System

**Application:**

- designed for on-site refueling of construction, mining, forestry and agricultural equipment

### Diesel Fuel Nozzles

**Features:**

- 1½" female NPT
- tested to 180 gallons per minute
- integrated high flow swivel and sealing plug
- plug/bumper assembly gives complete nose seal
- investment cast aluminum housing
- anodized aluminum non-wear parts
- stainless steel wear components
- Delron® bushings eliminate metal-to-metal wear
- interchanges with Caterpillar® and Wiggins systems



Description	Part #
dog latch mechanism with sealing plug	<b>FN600</b>
ball lock with sealing plug	<b>FN600BL</b>
sealing plug for FN600	<b>FN600B-PLUG</b>
sealing plug for FN600BL	<b>FN600B</b>

### One-Piece Diesel Fuel Receivers

**Features:**

- 2" male NPT
- O-ring sealed aluminum cap
- cap has set screw attached vinyl coated cable lanyard

Description	Material	Part #
one-piece receiver without cap	<i>nickel-plated steel</i>	<b>FRS</b>
one-piece receiver with cap	<i>nickel-plated steel</i>	<b>FRS-C</b>
one-piece receiver without cap	<i>anodized aluminum</i>	<b>FRA</b>
one-piece receiver with cap	<i>anodized aluminum</i>	<b>FRA-C</b>
cap for receiver	<i>anodized aluminum</i>	<b>FR-CAP</b>



### Two-Piece Diesel Fuel Receivers

**Features:**

- 2" male NPT
- O-ring sealed aluminum cap
- cap has set screw attached vinyl coated cable lanyard

Description	Part #
two-piece receiver with removable stainless sleeve, without cap	<b>FR-RS</b>
two-piece receiver with removable stainless sleeve with cap	<b>FR-RS-C</b>
removable sleeve replacement for two-piece receiver	<b>FR-RS-R</b>
cap for receiver	<b>FR-CAP</b>



## FloMAX Diesel Fueling System

## Non-Interchange Diesel Fuel Nozzle

**Application:**

- used in biodiesel fueling

**Features:**

- 1½" female NPT
- design prevents fuel contamination
- connects to the non-interchange receiver only
- ball lock design

Description	Part #
ball lock fuel nozzle	<b>FN600BL-NI</b>

## Non-Interchange Diesel Fuel Receiver

**Application:**

- used in biodiesel fueling

**Features:**

- design prevents fuel contamination
- connects to the non-interchange nozzle only
- ball lock design

Description	Anodized Aluminum Part #
one-piece receiver with cap	<b>FRA-NI-C</b>

## 2" High Volume Diesel Fueling System

**Features:**

- capable of flowing over 400 GPM
- 2" female NPT
- stainless steel ball lock design
- removable pull back assembly

**Materials:**

- housing: aluminum
- non-wear parts: anodized aluminum
- internal wear components: stainless steel
- bushings: Delron®

## Diesel Fuel Nozzles



Description	Part #
2" fuel nozzle	<b>FX1500<sup>1</sup></b>
2" fuel nozzle - with plug	<b>FX1500P<sup>1</sup></b>
2" fuel nozzle - with swivel	<b>FX1500S<sup>1</sup></b>
2" fuel nozzle - with swivel, with plug	<b>FX1500SP<sup>1</sup></b>
2" sealing plug for nozzle	<b>FX1500PLUG</b>

<sup>1</sup> must be used with high flow fuel vents found on page 21

## Diesel Fuel Receivers



Description	Part #
2" diesel fuel receiver	<b>FRX</b>
2" fuel receiver with cap	<b>FRX-C</b>
2" cap for receiver	<b>FRXCAP</b>

## Diesel Fuel Gravity Fill Receivers

**Feature:**

- used with the FN600 or FN600BL to convert to gravity fueling

Size	Description	Part #
1 3/8"	straight	<b>GFR-0</b>
1 3/8"	45°	<b>GFR-45</b>
1 3/8"	90°	<b>GFR-90</b>
1"	straight	<b>GFR1-0</b>
1"	45°	<b>GFR1-45</b>
1"	90°	<b>GFR1-90</b>

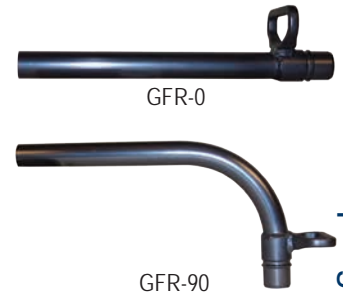

Engineered Fluid Transfer Couplings

## Fuel Vents

**Features:**

- 2" male NPT
- billet cap provides superior impact resistance
- easily serviced all metal construction
- rigid ball cage for positive seal
- available with: threaded outlet, half coupling and anti-vandalism mounting

Description	Part #
vent with 5" tube	<b>VT</b>
vent with 7" tube	<b>VT7</b>
vent with 9" tube	<b>VT9</b>
vent with 5" tube and threaded outlet	<b>VTT</b>



## High Flow Fuel Vents

**Feature:**

- 7" tubes are available, contact Dixon® for more information

Description	Part #
high flow fuel vent with 5" tube	<b>VTX</b>
high flow fuel vent with 9" tube	<b>VTX-9</b>



## Diesel Fuel Swivels

**Features:**

- stainless steel male threaded base and ball bearings
- hard black anodized female threaded nut
- fluorosilicone sealing O-rings

Thread Size	Description	Part #
1 1/2" male NPT x 1 1/2" female NPT	standard	<b>FNS</b>
2" male NPT x 1 1/2" female NPT	standard	<b>FNS2</b>
1 1/2" female NPT x 1 1/2" female NPT	double	<b>FNSID</b>
1 1/2" male NPS x 1 1/2" female NPT	standard	<b>FN600S<sup>1</sup></b>

<sup>1</sup> used with FN600 or FN600BL



## Service Box

**Features:**

- Designed to enclose receivers for diesel fuel, hydraulic oil, transmission fluid and coolant reducing contamination and weather related problems.
- normally installed on heavy duty earth mover equipment and drill rigs
- 12 gauge steel construction with heavy duty hinges
- painted with Imron® Primer

Part #
<b>FSB</b>



receivers sold separately

## Standard Series Connectors

**Features:**

- standard series connectors consist of four color-coded mating connectors
- all-metal construction with stainless steel wear components and anodized aircraft grade aluminum non-wear components
- easily recognizable labeling
- fully compatible and interchangeable with industry standards

**Engine Oil Nozzles****Features:**

- **bright red**
- universally fits both R-series and Standard series crankcase receivers
- incorporates 10 locking balls with a 40% deeper engagement
- resistant to clogging with a greater ease of cleaning
- smooth actuation
- larger diameter pullback lanyard



Male Thread	Description	Anodized Aluminum Part #
3/4" NPT	engine nozzle ball lock	<b>ENBL</b>
3/4" NPT	engine nozzle ball lock with plug	<b>ENBL-P</b>
---	engine nozzle plug	<b>ENBL-PLUG</b>

**Engine Oil Receivers**

ERS-C



ERJ-C

Male Thread	Description	Anodized Aluminum Part #
3/4" NPT	engine receiver	<b>ERS</b>
3/4" NPT	engine receiver with cap	<b>ERS-C</b>
---	engine receiver cap	<b>ERS-CAP</b>
3/4" JIC	engine receiver with JIC bulkhead base	<b>ERJ</b>
3/4" JIC	engine receiver with JIC bulkhead base and cap	<b>ERJ-C</b>

**Coolant Fluid Nozzles****Features:**

- **bright teal**
- standard roll-pin locking mechanism
- ergonomically engineered pullbacks and caps



Male Thread	Description	Anodized Aluminum Part #
1/2" NPT	coolant nozzle ball lock	<b>CN</b>
1/2" NPT	coolant nozzle ball lock with plug	<b>CN-P</b>
---	coolant nozzle plug	<b>CN-PLUG</b>

**Coolant Fluid Receivers**

Male Thread	Description	Anodized Aluminum Part #
1/2" NPT	coolant receiver	<b>CR-S</b>
1/2" NPT	coolant receiver with cap	<b>CR-C</b>
---	coolant receiver cap	<b>CR-CAP</b>



Standard Series Connectors

Hydraulic Oil Nozzles

Features:

- bright gold
- 10 steel dog latching mechanism
- ergonomically engineered pullbacks and caps

Female Thread	Description	Anodized Aluminum Part #
3/4" NPT	hydraulic nozzle	<b>HN</b>
3/4" NPT	hydraulic nozzle with plug	<b>HN-P</b>
---	hydraulic nozzle plug	<b>HN-PLUG</b>



Hydraulic Oil Receivers

Male Thread	Description	Anodized Aluminum Part #
3/4" NPT	hydraulic receiver	<b>HR</b>
3/4" NPT	hydraulic receiver with cap	<b>HR-C</b>
---	hydraulic receiver cap	<b>HR-CAP</b>



Transmission Fluid Nozzles

Features:

- bright violet
- 6 steel dog latching mechanism
- ergonomically engineered pullbacks and caps

Male Thread	Description	Anodized Aluminum Part #
1/2" NPT	transmission nozzle	<b>TN</b>
1/2" NPT	transmission nozzle with plug	<b>TN-P</b>
---	transmission nozzle plug	<b>TN-PLUG</b>



Transmission Fluid Receivers

Female Thread	Description	Anodized Aluminum Part #
3/8" NPT	transmission receiver	<b>TR</b>
3/8" NPT	transmission receiver with cap	<b>TR-C</b>
---	transmission receiver cap	<b>TR-CAP</b>



**R Series Connectors**

**Features:**

- fully compatible and interchangeable with industry standards
- all-metal construction using anodized aircraft grade aluminum non-wear components
- standard roll-pin locking mechanism
- ergonomically engineered pullbacks and caps

**Engine Oil Nozzles**

**Feature:**

- **bright red**



Female Thread	Description	Anodized Aluminum Part #
3/4" NPT	R-series engine nozzle	<b>R-EN</b>
3/4" NPT	R-series engine nozzle with plug	<b>R-EN-P</b>
---	R-series engine nozzle plug	<b>R-EN-PLUG</b>

**Engine Oil Receivers**



Male Thread	Female Thread	Description	Anodized Aluminum Part #
1.625-12 UN-2A	1.312-12 UN-2B	R-series engine receiver	<b>R-ER</b>
1.625-12 UN-2A	1.312-12 UN-2B	R-series engine receiver with cap	<b>R-ER-C</b>
---	---	R-series engine receiver cap	<b>R-ER-CAP</b>

**Coolant Fluid Nozzles**

**Feature:**

- **bright teal**



Female Thread	Description	Anodized Aluminum Part #
1/2" NPT	R-series coolant nozzle	<b>R-CN</b>
1/2" NPT	R-series coolant nozzle with plug	<b>R-CN-P</b>
---	R-series coolant nozzle plug	<b>R-CN-PLUG</b>

**Coolant Fluid Receivers**



Male Thread	Female Thread	Description	Anodized Aluminum Part #
1.187-12 UN-2A	.875-14 UN-2B	R-series coolant receiver	<b>R-CR</b>
1.187-12 UN-2A	.875-14 UN-2B	R-series coolant receiver with cap	<b>R-CR-C</b>
---	---	R-series coolant receiver cap	<b>R-CR-CAP</b>

## R Series Connectors

### Hydraulic Oil Nozzles

**Feature:**

- bright gold

Female Thread	Description	Anodized Aluminum Part #
1" NPT	R-series hydraulic nozzle	<b>R-HN</b>
1" NPT	R-series hydraulic nozzle with plug	<b>R-HN-P</b>
---	R-series hydraulic nozzle plug	<b>R-HN-PLUG</b>

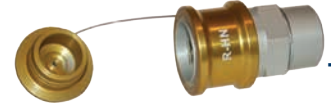

### Hydraulic Oil Receivers

Male Thread	Female Thread	Description	Anodized Aluminum Part #
1.875-12 UN-2A	1.625-12 UN-2B	R-series hydraulic receiver	<b>R-HR</b>
1.875-12 UN-2A	1.625-12 UN-2B	R-series hydraulic receiver with cap	<b>R-HR-C</b>
---	---	R-series hydraulic receiver cap	<b>R-HR-CAP</b>

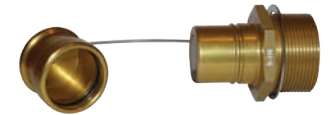

### Transmission Fluid Nozzles

**Feature:**

- bright violet

Female Thread	Description	Anodized Aluminum Part #
3/4" NPT	R-series transmission nozzle	<b>R-TN</b>
3/4" NPT	R-series transmission nozzle with plug	<b>R-TN-P</b>
---	R-series transmission nozzle plug	<b>R-TN-PLUG</b>



### Transmission Fluid Receivers

Male Thread	Female Thread	Description	Anodized Aluminum Part #
1.312-12 UN-2A	1.062-12 UN-2B	R-series transmission receiver	<b>R-TR</b>
1.312-12 UN-2A	1.062-12 UN-2B	R-series transmission receiver, cap	<b>R-TR-C</b>
---	---	R-series transmission receiver cap	<b>R-TR-CAP</b>



## High Flow ¾" Series Connectors

## Features:

- 6 nozzle and receiver sets color coded for quick identification of mating parts; each color nozzle and receiver only couples with matching color component providing complete protection against cross contamination
- maximum flow rate: 50 GPM at 40 PSI
- working pressure rating: **200 PSI**



## Nozzles

Male Thread	Description	Anodized Aluminum Part #
¾" NPT	red nozzle with plug	<b>ENBL-P</b>
	gold nozzle with plug	<b>ENBL-P2</b>
	teal nozzle with plug	<b>ENBL-P3</b>
	violet nozzle with plug	<b>ENBL-P4</b>
	navy nozzle with plug	<b>ENBL-P5</b>
	copper nozzle with plug	<b>ENBL-P6</b>

## Receivers

Male Thread	Description	Anodized Aluminum Part #
¾" NPT	red receiver with cap	<b>ERS-C</b>
	gold receiver with cap	<b>ERS-C2</b>
	teal receiver with cap	<b>ERS-C3</b>
	violet receiver with cap	<b>ERS-C4</b>
	navy receiver with cap	<b>ERS-C5</b>
	copper receiver with cap	<b>ERS-C6</b>

- ERS series is available with JIC bulkhead base, substitute 'J' for 'S', example: ERJ-C2



## High Flow 1" Series Connectors

## Features:

- 7 color coded nozzle and receiver sets for quick identification of mating parts; nozzle and receiver only couple with matching color component providing complete protection against cross contamination
- nozzle/receiver combination has a flow area equivalent to a 1" schedule 80 pipe
- working pressure: **500 PSI** with burst pressure: **1500 PSI**
- all wear parts are stainless steel; all non-wear parts are colored anodized aircraft grade aluminum
- standard nozzle mounting: 1" female NPT; receiver: 1" male NPT
- nozzle incorporates a ball lock mechanism ensuring smooth and reliable operation
- length: nozzle 3.90" (99 mm), receiver 3.44" (87 mm)
- nozzle and receiver coupled length: 5.44" (138 mm)
- diameter: 2.50" (64 mm)
- hex size: 2" (51 mm)

## Nozzles

Female NPT	Description	Anodized Aluminum Part #
1"	red nozzle with plug	<b>HFN-P1</b>
	gold nozzle with plug	<b>HFN-P2</b>
	teal nozzle with plug	<b>HFN-P3</b>
	violet nozzle with plug	<b>HFN-P4</b>
	navy nozzle with plug	<b>HFN-P5</b>
	copper nozzle with plug	<b>HFN-P6</b>
	blue/gray nozzle with plug	<b>HFN-P7</b>



## Receivers

Male NPT	Description	Anodized Aluminum Part #
1"	red receiver with cap	<b>HFR-C1</b>
	gold receiver with cap	<b>HFR-C2</b>
	teal receiver with cap	<b>HFR-C3</b>
	violet receiver with cap	<b>HFR-C4</b>
	navy receiver with cap	<b>HFR-C5</b>
	copper receiver with cap	<b>HFR-C6</b>
	blue/gray receiver with cap	<b>HFR-C7</b>



FloMAX Part Number Cross Reference

Standard Series Connectors

Dixon® Part #	Caterpillar® Part #	Wiggins Part #
Engine Oil Nozzles		
ENBL	9S9273	OS2
ENBL-P	---	OSP2
ENBL-PLUG	9S9274	OP-12
ERJ	---	ON6
Engine Oil Receivers		
ERS	9S9271	ON2
ERS-C	---	ONC2A
ERS-CAP	9S9272	O3B12P
Coolant Fluid Nozzles		
CN	108-5455	EC280B8
CN-P	---	---
CN-PLUG	108-5456	1209-8
Coolant Fluid Receivers		
CR-S	IQ5459	EC285A8
CR-C	---	---
CR-CAP	5P3587	1208-8
Hydraulic Oil Nozzles		
HN	108-5433	6000B12
HN-P	---	---
HN-PLUG	---	6009-12
Hydraulic Oil Receivers		
HR	108-5454	6005A12
HR-C	---	---
HR-CAP	IQ-5468	6008-12
Transmission Fluid Nozzles		
TN	126-7538	C-1807
TN-P	---	---
TN-PLUG	---	P-1844
Transmission Fluid Receivers		
TR	108-5456	P-1804
TR-C	---	---
TR-CAP	SP3587	P-1880

R Series Connectors

Dixon® Part #	Caterpillar® Part #	Wiggins Part #
Engine Oil Nozzles		
R-EN	---	R15
R-EN-P	---	---
R-EN-PLUG	---	R1507
Engine Oil Receivers		
R-ER	---	R16
R-ER-C	---	---
R-ER-CAP	---	R1605
Coolant Fluid Nozzles		
R-CN	---	R11
R-CN-P	---	---
R-CN-PLUG	---	R1107
Coolant Fluid Receivers		
R-CR	---	R12
R-CR-C	---	---
R-CR-CAP	---	R1205
Hydraulic Oil Nozzles		
R-HN	---	R17
R-HN-P	---	---
R-HN-PLUG	---	R1707
Hydraulic Oil Receivers		
R-HR	---	R18
R-HR-C	---	---
R-HR-CAP	---	R1805
Transmission Fluid Nozzles		
R-TN	---	R13
R-TN-P	---	---
R-TN-PLUG	---	R1307
Transmission Fluid Receivers		
R-TR	---	R14
R-TR-C	---	---
R-TR-CAP	---	R1405

Diesel Fueling System

Dixon® Part #	Caterpillar® Part #	Wiggins Part #
Nozzles		
FN600	---	ZZF150
FN600BL	---	ZZ9A1
FN600B-PLUG	---	---
Receivers		
FRS	2G9000	ZN2A
FRS-C	---	ZNC2A
FRA	---	ZN2A
FRA-C	---	ZNC2A
FR-CAP	0D0630	ZC20P
FR2	9D0630	---
FR2-C	---	---
FR2-R	---	---
GFR-0	---	ZN6A
GFR-45	---	---
GFR-90	---	ZN6B
GFR1-0	---	ZN6B
GFR1-45	---	---
GFR1-90	---	ZN6B
FNS	---	ZS9
FNS2	---	---
FN600S	---	---
BFN	---	ZS5
BH-F	---	---
FNS10	---	---
FR-SOCKET	---	---
BH-W	---	---

Fuel Vent Series

Dixon® Part #	Caterpillar® Part #	Wiggins Part #
VT	6G7803	ZV10
VT7	---	ZV10F
VT9	---	ZV10
VTT	5V6106	ZV10C
VT-C	---	ZV10A
VT-A-7	9G01965	ZV11
VT-A-9	4T1314	ZV11A

## API Couplers

## Features:

- completely modular coupler can be built with various face seal combinations to be compatible with different alternative fuel / performance levels and applications
- 4" TTMA inlet mounting flange
- 5 cam design for easy alignment and tight connection
- ball-end handle for easy, comfortable operation
- no special tools needed for maintenance
- shaft seals can be changed without removing coupler from loading arm
- link, shaft, pin and crank: hardened 17-4PH stainless steel
- cam: stainless steel
- weight: 20 lbs.
- 5300, 5300B, 5300BC, 5300BCL: maximum working pressure **150 PSI**  
5300G: maximum working pressure **100 PSI**  
5400: maximum working pressure **75 PSI**
- peak surge pressure: **350 PSI**
- maximum flow rate: 600 GPM, (2271 LPM)
- pressure drop: **3 to 4 PSI**
- seal color code: FKM - brown dot; FKM B - yellow dot, FKM GFLT - green dot
- replacement parts are available, contact Dixon®



## API Couplers with Bonded Nose Seal

Seal Material	Operating Temperature	Part #
<i>Buna</i>	-20°F to 250°F (-29°C to 121°C)	<b>5300</b>
<i>FKM-B</i>	-10°F to 400°F (-23°C to 204°C)	<b>5300B</b>
<i>FKM-GFLT</i>	-20°F to 400°F (-29°C to 204°C)	<b>5300G</b>
<i>FKM-B with stainless wave spring</i>	-10°F to 400°F (-23°C to 204°C)	<b>5300BC<sup>1</sup></b>
<i>FKM-B with stainless wave spring</i>	-10°F to 400°F (-23°C to 204°C)	<b>5300BCL</b>

<sup>1</sup> stainless steel internal springs and is recommended for crude oil service

## API Couplers with Replaceable Nose Seal

Seal Material	Operating Temperature	Part #
<i>Buna</i>	-20°F to 250°F (-29°C to 121°C)	<b>5400</b>
<i>FKM-B</i>	-10°F to 400°F (-23°C to 204°C)	<b>5400B</b>
<i>FKM-GFLT</i>	-20°F to 400°F (-29°C to 204°C)	<b>5400G</b>

## API Coupler Locking Handle Repair Kit



Description	Part #
locking handle kit for 5300BC rack couplers	<b>5354K21</b>

## API Load Only Valves

## Application:

- used for bottom loading and unloading of petroleum tankers, typically mounted to the piping below each tank compartment using the built-in 4" TTMA flange connection

## Features:

- unique fluid flow sight level
- ergonomically curved handle operates on a short 62° degree stroke
- Nose ring is anodized hard coat aluminum, which in most applications will provide years of trouble free service. Nose ring can be rotated to provide a fresh connection surface.



Description	Part #
load only API valve without sight glass, ALH nose ring	<b>5204LNG</b>
load only API valve without sight glass, Baylast™ seal, stainless steel springs	<b>5204LSNG</b>
load only API valve without sight glass, Baylast™ seal, stainless steel springs with ½" FNPT drain port	<b>5204LSNGP</b>



## API Load/Unload Valves

Description	Part #
load/unload API valve with sight glass, fixed handle, ALH nose	<b>5204</b>
load/unload API valve, without sight glass, fixed handle, Baylast™ seal	<b>5204NG</b>

API Drop Adapters

**Application:**

- for offloading through an API adapter

Adapter Size	Coupler Size	Description	Aluminum Part #
3"	4" API	with Baylast™ O-ring seal	<b>4530</b>
4"	4" API	with Baylast™ O-ring seal	<b>4540</b>
4"	4" API	with Buna-N O-ring seal	<b>4540F</b>



**API Drop Adapters with Sight Glass**

Adapter Size	Coupler Size	Description	Aluminum Part #
3"	4" API	with inline sight glass and Baylast™ flat gasket	<b>4530SG</b>
4"	4" API	with inline sight glass and Baylast™ flat gasket	<b>4540SG</b>



**API Gravity Drop Adapters**

Adapter Size	Coupler Size	Description	Aluminum Part #
3"	4" API	with flat Buna gasket	<b>31440-225AL</b>
4"	4" API	with flat Buna gasket	<b>41440-225AL</b>



**API Drop Adapter Repair Kits**

Description	Part #
replacement cam arms, pins and Baylast™ O-ring seal (standard)	<b>4500RK</b>
replacement cam arms, pins and FKM O-ring seal (optional)	<b>4500RK-V</b>
replacement 18" chain and S hook	<b>5205-RK4</b>
sight glass repair kit (fits 3" and 4")	<b>4540SG-RK1</b>
flat replacement Baylast gasket for 4530SG, 4540SG	<b>4540SG-RK2</b>
replacement cam arms and pins (fits 3" and 4")	<b>4540SG-RK3</b>
Baylast O-ring replacement seal for 4530, 4540, 5000-24	<b>4500-5</b>
flat replacement gasket for 31440-225AL, 41440-225AL, 41450-DCAL	<b>2143SEALBU</b>



4540SG-RK1

**API Dust Caps**

Size	Description	Aluminum Part #	Optional Qty
4" API	with flat Buna gasket and brass cam arms	<b>41450-DCAL</b>	5
	with O-ring Baylast™ seal and brass cam arms	<b>5000-24</b>	10
	with locking arms	<b>5000-24L</b>	1



with cam arms

Adapter Size	Description	Nylon Part #	Optional Qty
4" API	with flat Buna seal and plated steel pad lockable roller lever	<b>5000-25</b>	20



with locking arms

## Gravity Drop Adapter Dust Caps



4540DC

**Features:**

- designed to fit on any 4" cam and groove adapter, specifically 4" gravity drop adapters
- reduce weight
- easy Pull Off / Push On operation
- Buna gasket
- NOT intended to be pressurized 



4540DC-1200

Size	Black Nylon Part #
4"	<b>4540DC</b>
4"	<b>4540DC-1200<sup>1</sup></b>

<sup>1</sup> supplied with chain

## Dixon Bayco Adapter with Grounding Tab



Size	Description	356T6 Aluminum Part #
4"	male adapter with grounding tab	<b>400-E-ALGT</b>

## Dixon Bayco Coupler with Grounding Tab



Size	Description	356T6 Aluminum Part #
4"	female coupler with grounding tab	<b>400-C-ALGT</b>



## API Compatible Loading Rack Cords

**Features:**

- highly visible safety orange jacket meets trip hazard requirements
- cord is bonded mechanically and resistant to abrasion and oil
- Cord sets are interchangeable with Scully and Civacon. All wiring is compatible with standard Scully color codes and wiring number configurations. The 9 pin conductor is shielded to be compatible with Scully VIP system.
- plug body is reinforced nylon and is color coded Optic Blue or Thermistor Green
- button contacts are 316 stainless steel to prevent corrosion or galling
- all other hardware is stainless steel

### API Optic Cord Assemblies

Description	Part #
plug with 30' coiled cable, 6 contact pins, 3 J slots	<b>FT620</b>
plug with 20' straight cable, 6 contact pins, 3 J slots	<b>FT620S</b>
plug with 30' coiled cord, 6 contact pins, 3 J slots, J560 plug	<b>FT620P</b>
replacement plug assembly with 6 contact pins, 3 J slots	<b>FT621</b>
replacement 30' coiled cable, optic 6 conductor	<b>FT622</b>
plug storage hanger	<b>FT623</b>
replacement 20' straight cord, optic 6 conductor	<b>FT624</b>



FT620

### API Thermistor Cord Assemblies

Description	Part #
plug with 30' coiled cable, 8 contact pins, 2 J slots	<b>FT600</b>
plug with 30' coiled cable, 8 contact pins, 2 J slots, 13 pin connector	<b>FT600P</b>
plug with 30' coiled cord, 10 contact pins, 2 J slots (for Canada)	<b>FT600C</b>
plug with 20' straight cable, 8 contact pins, 2 J slots	<b>FT600S</b>
plug with 20' straight cable, Thermistor conductor, 8 contact pins, 4 J slots	<b>FT600S-4</b>
plug with 30' coiled cable, 10 contact pins, 4 J slots	<b>FT600CP</b>
plug with 20' straight cable, 10 contact pins, 4 J slots (for Canada)	<b>FT600SC</b>
replacement plug assembly with 8 contact pins, 2 J slots	<b>FT601</b>
replacement plug assembly with 10 contact pins, 4 J slots (for Canada)	<b>FT601-10</b>
replacement 30' coiled cable, Thermistor 10 conductor	<b>FT602</b>
plug storage hanger	<b>FT603</b>
replacement 20' straight cord, Thermistor 10 conductor	<b>FT604</b>



FT600

- Rack cord part number competitor cross references can be found on the following page.

## API Rack Cord Assemblies

FloTech™ Part #	Civacon Part #	Scully Part #	API		Cord		J-Slots			Pins			Breakaway Plug	
			Thermistor	Optic	20' Straight	30' Coiled	2	3	4	6	8	10	Optic J560 Aluminum	Thermistor 13 Pin Plastic
<b>FT600</b>	7300SR-7300	21818	✓			✓	✓				✓			
<b>FT600-4</b>			✓			✓			✓	✓				
<b>FT600C</b>	7300CSR-7300	31092	✓			✓			✓		✓			
<b>FT600C-2</b>	7300C-7300		✓			✓					✓			
<b>FT600P</b>	7320SR-7320		✓			✓					✓			✓
<b>FT600P-4</b>			✓			✓			✓	✓				✓
<b>FT600S</b>	7300-STRAIGHT	20830	✓		✓			✓			✓			
<b>FT600SC</b>	7300C-STRAIGHT		✓		✓				✓		✓			
<b>FT600CP</b>			✓			✓			✓		✓			✓
<b>FT600SP</b>			✓					✓			✓			✓
<b>FT605C</b>				✓		✓			✓	✓				
<b>FT620</b>	7100SR-7100	21831		✓		✓		✓	✓					
<b>FT620P</b>	7100-J560			✓		✓		✓	✓				✓	
<b>FT620X620</b>				✓		✓		✓	✓					
<b>FT620S</b>	7100-STRAIGHT	21764		✓	✓			✓	✓					

## API Rack Cord Parts

FloTech™ Part #	Civacon Part #	Scully Part #	API		Cord		J-Slots			Pins			
			Thermistor	Optic	20' Straight	30' Coiled	2	3	4	6	8	10	
<b>FT601</b>	7310SR-7310		✓					✓				✓	
<b>FT601-4</b>			✓							✓		✓	
<b>FT601-10</b>			✓							✓			✓
<b>FT602</b>			✓				✓						
<b>FT603</b>	7350-7350		✓							✓			
<b>FT604</b>			✓		✓								
<b>FT621</b>	7110SR-7110	21766		✓					✓		✓		
<b>FT622</b>	7220-7220	31099		✓					✓				
<b>FT623</b>	7150-7150			✓					✓				
<b>FT624</b>		31098		✓	✓		✓						



FT590TG

## FloTech™ FT590 Series Rack Monitor Testers

Description	Part #
rack tester with grounding bolt	<b>FT590TG</b>
rack tester thermistor	<b>FT590TGT</b>
rack tester with ground bolt	<b>FT590OG</b>
rack tester with ground bolt and Trailer Identification Module	<b>FT590OGT</b>

Dixon® Vapor Recovery Couplers

- not intended for liquid service, for vapor recovery *only* 

**Materials:**

- body: cast aluminum
- arms: bronze with stainless steel pins
- finger rings: plated carbon steel
- gasket: Buna-N

**Coupler with Probe x Adapter**

Coupler Size	Adapter Size	356T6 Aluminum Part #
4"	3"	<b>4030-DAVR-AL</b>



**Coupler with Probe x Coupler with Probe**

Coupler Size	Coupler Size	356T6 Aluminum Part #
4"	4"	<b>400-DDVR-AL</b>



**Coupler with Probe x Hose Shank**

**Applications:**

- for use with 3" vapor hose
- not intended for liquid service, for vapor recovery *only* 

**Materials:**

- cast aluminum body
- arms : bronze
- pins and finger rings: stainless steel
- gasket: Buna-N



VR4030CS-AL

**Features:**

- VR4030CS-AL has an FKM O-ring poppet seal 
- Dixon® replacement handle assemblies will not work on these fittings, contact Dixon® for replacements.

Coupler Size	Hose Shank Size	Description	Part #
3"	3"	---	<b>VRC3000AL</b>
4"	2"	---	<b>4020-CVR-AL</b>
4"	3"	no poppet	<b>4030-CVR-AL</b>
4"	3"	poppet	<b>VR4030CS-AL</b> <sup>1</sup>
4"	3"	floating bridge poppet	<b>VR4030CS-SH</b> <sup>2</sup>
4"	4"	no poppet	<b>400-CVR-AL</b>
4"	4"	floating bridge poppet	<b>VR4040CS-AL</b> <sup>2</sup>



VRC.3000AL

<sup>1</sup> interchanges with all competitor vapor valves *except* Civacon #633LVH (special bulb design). 

<sup>2</sup> superior interface with air interlock

**Repair Kits**

Description	Part #
seal repair kit: gasket, machine screw and FKM O-ring	<b>VR4040CSRK1</b>
cam arm repair kit: paddle arm and cam arm pin	<b>VR4040CSRK2</b>



4030-CVR-AL

## Dixon® Vapor Recovery

## Couplers

## Material:

- seal: Buna N and FKM

## Features:

- 'floating bridge' poppet design allows optimal flow
- machined hose shank ensures easier insertion into hose and better sealing
- durable, easy to couple stainless cam arms
- big wings ensure contact with air interlock button on tanker helping prevent drive-offs
- change poppet seal without removing the coupler from the hose
- secure to hose with traditional band clamps or built in crimp collar
- 4" MNPT version allows for either cam and groove or threaded flange option
- not intended for liquid service, for vapor recovery *only*



VR4030CS-AL45



VR4040CS-AL

Coupler Size	Description	Aluminum Part #
4"	4" coupler x 4" hose shank	<b>VR4040CS-AL</b>
	4" coupler x 3" 45° hose shank	<b>VR4030CS-AL45</b>
	4" coupler x 4" 45° hose shank	<b>VR4040CS-AL45</b>
	4" coupler x 4" 45° hose shank swivel	<b>VR4040CS-ALS45</b>
	4" coupler x 4" MNPT connection	<b>VR4040CS-4MNPT</b>
	4" coupler x 3" hose shank	<b>VR4030CS-SH</b>

## Repair Kits



VRHK

Description	Part #
handle kit	<b>VRHK</b>
compact handle kit	<b>VRHK-C</b>
seal repair kit	<b>VR4040CSRK1</b>
cam arm repair kit	<b>VR4040CSRK2</b>

## Coupler x Female NPT



- not intended for liquid service, for vapor recovery *only*

## Materials:

- body: cast aluminum
- arms: bronze with stainless steel pins
- finger rings: plated carbon steel
- gasket: Buna-N

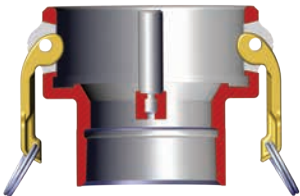

Coupler Size	Female NPT Size	356T6 Aluminum Part #
4"	3"	<b>4030-DVR-AL</b>
	4"	<b>400-DVR-AL</b>

Tank Truck Flanged Tee

Size	356T6 Aluminum Part #
4"	<b>400-TLT-AL</b>



• For flange dimensions, diagrams and additional information please reference dixonvalve.com.

TTMA Series Flange Adapters

**Features:**

- simply and easily converts threaded components to a standard TTMA flange configuration
- solid cast lightweight aluminum design is more durable than welded fabrications
- design improves flow through adapter
- compact size reduces the overall space needed to install

**TTMA Flange x Male NPT Adapters**

TTMA Flange	Male NPT	Overall Length	Aluminum Part #
3"	3"	2½"	<b>TTF3AL-3MT</b>
4"	3"	2½"	<b>TTF4AL-3MT</b>
4"	4"	2½"	<b>TTF4AL-4MT</b>



**TTMA Flange x Extended Length Male NPT Adapters**

TTMA Flange	Male NPT	Overall Length	Aluminum Part #
4"	3"	5½"	<b>TTF4AL-3EMT</b>
	4"	5½"	<b>TTF4AL-4EMT</b>



**TTMA Flange x Female NPT Adapter**

TTMA Flange	Female NPT	Overall Length	Aluminum Part #
4"	3"	2½"	<b>TTF4AL-3FT</b>
	4"	2½"	<b>TTF4AL-4FT</b>



**TTMA Slip-on Socket Weld Flange**

TTMA Flange	Pipe Size	356T6 Aluminum Part #
4"	4"	<b>TTF400SP</b>



**TTMA Slip-on Plate Flange**

TTMA Flange	Pipe Size	Aluminum Part #
4"	4"	<b>TTMA-64</b>



**TTMA Buttweld Flange**

TTMA Flange	Pipe Size	Thickness	Aluminum Part #
3"	4"	⅜"	<b>TTF3AL</b>
4"	4"	⅜"	<b>TTF4AL</b>



• For flange dimensions, diagrams and additional information please reference dixonvalve.com.

## Tank Truck Fittings: TTMA Flange Adapter

## TTMA Flange Spacer with ½" Port



Size	Description	Aluminum Part #
4"	flange spacer with ½" female NPT port	<b>TTFS4AL-FP50</b>

## TTMA Flange Extensions



TETF4AL



TETFG4AL

**Application:**

- used on load arms to connect an API load coupler to a load arm

**Features:**

- adds a 6" space between the load arm and the tank truck
- extension with groove provides a specified parting point to prevent excessive damage to the loading arm

Size	Description	Aluminum Part #
4"	TTMA flange extension	<b>TETF4AL</b>
4"	TTMA flange extension with groove	<b>TETFG4AL</b>
4"	TTMA flange extension with ½" female NPT port	<b>TETF4ALFP50</b>

- For flange dimensions, diagrams and additional information please reference dixonvalve.com.

## Cam &amp; Groove Adapter x TTMA Flange

**Features:**

- aluminum flanges have a flat face, stainless flanges have a raised face
- reference dixonvalve.com for flange drilling standards
- pressure rating is based on the seal of the mating part, see ratings on pages 123 - 124



Size	356T6 Aluminum Part #	316 Stainless Steel Part #
3"	<b>300-ALT-AL</b>	<b>300-ALT-SS</b> <sup>1</sup>
3" x 4"	<b>3040ALTAL</b>	---
4"	<b>400-ALT-AL</b>	<b>400-ALT-SS</b> <sup>1</sup>
6"	<b>600-ALT-AL</b>	---

- <sup>1</sup> parts are produced as a welded fabrication

## Cam &amp; Groove Coupler x TTMA Flange

**Features:**

- supplied standard with a Buna-N gasket, other gaskets available on pages 167 - 169
- use Dixon® replacement handles only



Size	356T6 Aluminum Part #
3"	<b>300-DLT-AL</b>
3" x 4"	<b>3040DLTAL</b>
4"	<b>400-DLT-AL</b>
6"	<b>600-DLT-AL</b>

- For flange dimensions, diagrams and additional information please reference dixonvalve.com.

## Cam &amp; Groove 22½° Adapter x TTMA Flange

**Feature:**

- pressure rating is based on the seal of the mating part, see ratings on page 123 - 124



Size	356T6 Aluminum Part #
4"	<b>40022ALTAL</b>

## Cam &amp; Groove 22½° Coupler x TTMA Flange

**Features:**

- supplied standard with a Buna-N gasket, other gaskets available on pages 167 - 169
- use Dixon® replacement handles only



Size	356T6 Aluminum Part #
4"	<b>40022DLTAL</b>

- For flange dimensions, diagrams and additional information please reference dixonvalve.com.

### TTMA Flange Gaskets

Size	OD	ID	Thick.	Material	Part #
3"	5-5/8"	3-1/2"	1/8"	Cork / Buna	<b>300GTTFCB</b>
	5-5/8"	3-1/2"	1/16"	PTFE envelope with Klinger filler	<b>300GTTFTK</b>
	5-5/8"	3-1/2"	1/8"	Klingersi® C-4300	<b>300GTTFK</b>
	5-29/32"	3-1/2"	3/32"	PTFE with fiber core	<b>40321TF</b>
	7-1/4"	5"	5/32"	PTFE with soft fiber core	<b>40364TF</b>
	7-1/4"	5"	1/8"	Baylast™	<b>40364BL</b>
	5-5/8"	3-5/8"	1/8"	Baylast™	<b>300GTTFBL</b>
4"	6-5/8"	4-9/16"	1/8"	Cork / Buna	<b>400GTTFCB</b>
	6-5/8"	4-9/16"	1/16"	PTFE envelope with Klinger filler	<b>400GTTFTK</b>
	6-5/8"	4-9/16"	1/8"	Klingersi® C-4401	<b>400GTTFK</b>
	6-7/8"	4-9/16"	3/32"	PTFE with fiber core	<b>40322TF</b>
	8-3/8"	5-7/8"	5/32"	PTFE with soft fiber core	<b>40323TF</b>
	8-1/4"	5-7/8"	1/8"	Baylast™	<b>40323BL</b>
	6-5/8"	4-5/8"	1/8"	Baylast™	<b>400GTTFBL</b>



• For flange dimensions, diagrams and additional information please reference [dixonvalve.com](http://dixonvalve.com).

### Sight Flow Indicators

**Features:**

- Due to the proprietary blending of petroleum products, Dixon® recommends that thermoplastic tubing and gaskets be immersion tested in the product to be handled to ensure compatibility (not compatible with crude oil).
- for dimensional information on tank truck flange drilling reference [dixonvalve.com](http://dixonvalve.com)
- maximum flange bolt torque is 200 in-lb (inch pounds)

### TTMA Flanged Short Sight Flow Indicators

**Features:**

- durable cast aluminum housing, replaces competitions all acrylic sight glass as commonly found on tank trucks
- allows for visual identification of the fuel grade prior to opening the valve
- works with tank truck flanged butterfly valves found on gasoline trucks
- low cost sight glass tube can be easily replaced
- rated to **150 PSI**

Size	Width	Aluminum Part #
3"	1¾"	<b>5200-SFI-3</b>
4"	1¾"	<b>5200-SFI</b>



### TTMA Flanged Sight Flow Indicators

**Features:**

- allows for visual identification of the fuel grade prior to opening the valve
- works with tank truck flanged butterfly valves found on gasoline trucks
- larger ID 4¾" flow indicator allows tank truck flanged butterfly valves to connect to either end of the indicator
- pressure rating: **150 PSI**

Size	Width	ID	Aluminum Part #
4"	3¼"	4¾"	<b>5201-SFI</b>



**Features:**

- allows for visual identification of the fuel grade prior to opening the valve
- 4" flow diameter

Size	ID	Aluminum Part #
4"	4¾"	<b>4-1460-AL</b>



• For flange dimensions, diagrams and additional information please reference [dixonvalve.com](http://dixonvalve.com).

## Tank Truck Fittings: Sight Flow Indicators

## TTMA Flanged Sight Flow Indicators



Size	Nominal Width	Acrylic Part #
3"	1¾"	<b>TT3ASG</b>
4"	1¾"	<b>TT4ASG</b>
3"	1¾"	<b>TT3ASG-ETH<sup>1</sup></b>
4"	1¾"	<b>TT4ASG-ETH<sup>1</sup></b>

## Optically Enhanced Sight Glass

Size	Nominal Width	Acrylic Part #
3"	1¾"	<b>TT3ASGOE</b>
4"	1¾"	<b>TT4ASGOE</b>
3"	1¾"	<b>TT3ASG-ETHOE<sup>1</sup></b>
4"	1¾"	<b>TT4ASG-ETHOE<sup>1</sup></b>

<sup>1</sup> for use with ethanol

- For flange dimensions, diagrams and additional information please reference [dixonvalve.com](http://dixonvalve.com).

## Sight Flow Indicator Repair Kits



5200-SFIV-RK1

Description	Used on	Part #
3" replacement sight glass, Baylast™ O-ring and retainer ring kit	---	<b>5200-SFI-3-RK1</b>
3" replacement sight glass, FKM O-ring and retainer ring kit	---	<b>5200-SFI-3V-RK1</b>
4" replacement sight glass, Baylast™ O-ring and retainer ring kit	---	<b>5200-SFI-RK1</b>
4" replacement sight glass, FKM O-ring and retainer ring kit	---	<b>5200-SFIV-RK1</b>
replacement Baylast O-rings, sight glass and retaining ring	5201-SFI	<b>5201-SFI-RK1</b>
Buna-N O-ring	---	<b>O249BU</b>
plexiglass insert	---	<b>4PSG</b>
Buna-N O-ring	---	<b>O246BU</b>

## TTMA Flange Screen

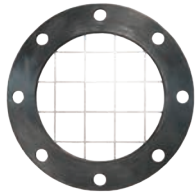

## Feature:

- stainless steel screen is encapsulated in an FKM gasket

Male NPT	Description	Stainless Steel Part #
2"	screen with 1" square holes	<b>TTFS4SS</b>

- For flange dimensions, diagrams and additional information please reference [dixonvalve.com](http://dixonvalve.com).



Betts Wet-R-Dri™ **Butterfly Valves**

**Application:**

- designed for handling liquid, gaseous or dry products

**Features:**

- has a positive stop in the open and closed position
- detent spring and ball assist in holding the disc in the open and closed position
- drilling fits TTMA recommended standards
- opens by turning hand ¼ turn counter clockwise
- temperature range: **0°F to 400°F (-18°C to 204°C)**

**Manual**

Size	Maximum Working Pressure PSI	Extruded aluminum body with FKM-B disc Part #
3"	<b>75</b>	<b>WD301ALVB</b>
4"	<b>75</b>	<b>WD401ALVB</b>



**Metering**

Size	Maximum Working Pressure PSI	Extruded aluminum body with FKM-B disc Part #
3"	<b>75</b>	<b>WD304ALVB</b>
4"	<b>75</b>	<b>WD404ALVB</b>



- For flange dimensions, diagrams and additional information please reference [dixonvalve.com](http://dixonvalve.com).

**Tank Transport Equipment**

**Fusible Pipe Caps**



Size	Stainless Steel <sup>1</sup> Part #	Aluminum Part #	Iron Part #	Optional Qty
3"	<b>300-SFC-SS</b>	<b>300-SFC-AL</b>	<b>300-SFC-MI</b>	10

<sup>1</sup> PTFE gaskets are standard in stainless steel fittings.

**Pipe Caps**



Size	Stainless Steel <sup>1</sup> Part #	Aluminum Part #	Iron Part #	Optional Qty
2"	<b>200-PC-SS</b>	---	<b>200-PC-MI</b>	---
3"	<b>300-PC-SS</b>	<b>300-PC-AL</b>	<b>300-PC-MI</b>	10
4"	<b>400-PC-SS</b>	---	---	---

<sup>1</sup> PTFE gaskets are standard in stainless steel fittings.

**Reducers**



Female NPSM	Male NPT	Stainless Steel <sup>1</sup> Part #	Aluminum Part #	Iron Part #	Optional Qty
3"	2"	<b>3020-RD-SS</b>	<b>3020-RD-AL</b>	<b>3020-RD-MI</b>	10
4"	3"	<b>4030-RD-SS<sup>2</sup></b>	<b>4030-RD-AL</b>	---	---

<sup>1</sup> PTFE gaskets are standard in stainless steel fittings.

<sup>2</sup> welded fabrication

**Reducing Cap**



Size	Stainless Steel <sup>1</sup> Part #	Optional Qty
3" x 1"	<b>3010-RC-SS</b>	10

<sup>1</sup> PTFE gaskets are standard in stainless steel fittings.

**Coupling Gaskets**



Buna-N



PTFE

Size	Buna-N Part #	Opt Qty	PTFE Part #	Opt Qty
1½"	---	--	<b>150GPCTF</b>	--
2"	<b>200GPCBU</b>	25	<b>200GPCTF</b>	10
3"	<b>300GPCBU</b>	25	<b>300GPCTF</b>	25
4"	---	--	<b>400GPCTF</b>	--

Intermodal Tank Transport

**Pipe Caps**

Size	Aluminum Part #	Stainless Steel <sup>1</sup> Part #	Optional Qty
3"	<b>300PCALAP</b>	<b>300PCSSAP</b>	10

<sup>1</sup> PTFE gaskets are standard in stainless steel fittings



**Thread Adapters**

Female BSPP	Male NPT	Stainless Steel <sup>1</sup> Part #
3"	2" 3"	<b>3020RDSSAP</b> <b>3030RDSSAP</b>

<sup>1</sup> PTFE gaskets are standard in stainless steel fittings



**Cam & Groove Adapter**

Size	Stainless Steel <sup>1</sup> Part #
3"	<b>300ASSAP</b>

<sup>1</sup> PTFE gaskets are standard in stainless steel fittings



6200 Series Side Lever Type Drop Elbows

**Materials:**

- cast aluminum modular construction
  - handle and cam arms: brass with buna gasket
  - bolts on inlet end: stainless steel
  - sight glass: acrylic with buna seals
- for information on additional elbow configurations such as pre-assembled elbows, contact Dixon®



side lever with 4" coupler inlet



side lever without inlet connection

Size	Inlet	A Overall Height	B Ground Clearance	Aluminum Part #
4"	elbow only, <i>without inlet connection</i>	17¾"	10⅞"	<b>6200</b>
	elbow with 4" adapter inlet			<b>6200A</b>
	elbow with anti-spill sleeve, <i>without inlet connection</i>			<b>6200T</b>
	elbow with 4" coupler inlet			<b>6200D</b>
4"	tall elbow only, <i>without inlet connection</i>	21"	13¾"	<b>6200X</b>
	tall elbow with 4" adapter inlet			<b>6200XA</b>
	tall elbow with anti-spill sleeve, <i>without inlet connection</i>			<b>6200XT</b>
	tall elbow with 4" coupler inlet			<b>6200XD</b>

6500 Series Self-Locking Drop Elbows



no inlet

Size	Inlet	A Overall Height	B Ground Clearance	Aluminum Part #
4"	tightfill elbow with locking handle	17¾"	10⅞"	<b>6500</b>
4"	tightfill elbow with locking handle and 4" adapter inlet	17¾"	10⅞"	<b>6500A</b>
4"	3" tight fill elbow with 4" inlet adapter	15"	9½"	<b>NEW</b> <b>6530A</b>
4"	3" tight fill elbow with 3" inlet adapter	15"	9½"	<b>NEW</b> <b>6530C</b>

Inlets

Male Adapters



Inlet Size	Aluminum Part #
3"	<b>6000-16</b>
4"	<b>6000-17</b>

Female Couplers



Inlet Size	Aluminum Part #
3"	<b>6000-15</b>
4"	<b>6000-14</b>

Female NPT



Inlet Size	Aluminum Part #
4"	<b>6000-20</b>

## Dual Point Vapor Recovery Elbows - Ball Lever

**Materials:**

- seals: buna
- hardware: stainless steel
- bronze locking arms housed in polymer bushings

**Features:**

- for use in two point vapor recovery systems
- one-piece locking arms
- advanced design side lever locking system
- bolt on 3" male outlet included (**VR6000-6**) which can be rotated for extended life
- lubrication fitting on locking stem
- see below for 6400 series co-axial elbow for single point vapor recovery



Description	Aluminum Part #
3" male adapter with probe, without poppet valve	<b>VR6200NP</b>
3" male adapter outlet with probe and poppet valve	<b>VR6200</b>

### Adapter Inlet

Description	Aluminum Part #
outlet adapter with outlet O-ring	<b>VR6000-6</b>



## Single Point Coaxial Drop Elbow

**Materials:**

- arms: solid bronze
- sight glass: acrylic
- seals: buna

**Features:**

- for single point vapor recovery only
- 3" male vapor outlet (top)
- comes assembled with 4" male inlet
- bolt-on inlets/outlets for easy, fast replacement
- replacement parts are available, please contact Dixon®
- 6400 co-axial inlets do not fit our other elbow series

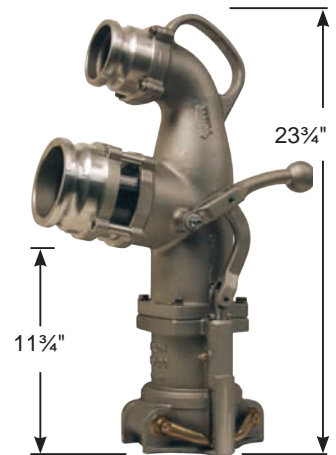

Inlet	Outlet	Aluminum Part #
4" male	3" male vapor	<b>6400</b>

## Coaxial Elbow Fuel Inlets

### Adapters

**Features:**

- for use with 6400 series coaxial elbows only
- rated for petroleum service, Ethanol to E100 and biodiesel to B20

Size	Aluminum Part #
3"	<b>6000-16C</b>
4"	<b>6000-17C</b>



### Couplers

**Features:**

- for use with 6400 series coaxial elbows only
- rated for petroleum service, Ethanol to E100 and biodiesel to B20

Size	Aluminum Part #
3"	<b>6000-15C</b>
4"	<b>6000-14C</b>



## Tank Truck Fittings: Fuel Elbows, Adapters &amp; Couplers

## Tight Fill Drop Elbows - Complete Unit

**Materials:**

- body: aluminum
- handle and cam arms: brass
- gasket: buna
- bolts on inlet end: steel
- sight flow insert: plexiglass

Coupler Size	Inlet	Aluminum Part #
3"	3" male adapter 4" male adapter	<b>300300MAE</b> <b>3004030MAE</b>

## Tight Fill Drop Elbow Coupler Body



Size	Aluminum Part #
3"	<b>300-TFG</b>

## Tight Fill Male Adapter Inlet End



Inlet	Aluminum Part #
3"	<b>300-MAE</b>
4"	<b>4030-MAE</b>

## Side Seal Drop Elbow

**Features:**

- for use with special 4" side seal style fill collars only
- modular, easy to repair, bolt together construction
- standard with acrylic sight glass with buna seals (2), bronze locking levers and buna main seal
- 4" male adapter inlet and lock ring installed
- replacement parts are available, contact Dixon®

Size	Aluminum Part #
4"	<b>6000ASAL</b>

## Side Seal to Top Seal Adapter

**Features:**

- allows conventional elbows to be used with special side seal style fill collars
- bottom connects to side seal fill collar
- top section with standard 4" top seal collar profile accepts clamping of standard 4" drop elbows
- replacement parts are available, contact Dixon®

Size	Aluminum Part #
4"	<b>6000-SSA</b>

### Dust Cap with Pull Handle for Hose Tubes

**Materials:**

- aluminum body
- cam arms (dust caps): brass
- seals: buna

**Features:**

- Pull handles make it easier for tanker operators to remove delivery hoses from the storage tubes; the operator simply grabs the handle and easily pulls the hose out of the storage tube.
- Rugged construction protects the hose coupling and adapter from damage during transportation and removal of hoses from the hose storage tube.
- prevents possible environmental issues due to leaking residue left in an open hose



4"

Size	Aluminum Part #
3"	<b>300-DC-ALPH</b>
4"	<b>400-DC-ALPH</b>

### Dust Plug with Pull Handle for Hose Tubes

Dust caps and dust plugs are not to be used in pressure applications for safety and environmental reasons.



3"



4"

Size	Aluminum Part #
3"	<b>300-DP-ALPH</b>
4"	<b>400-DP-ALPH</b>

### Reelcraft® Static Discharge Reel

**Application:**

- Used to ground equipment in hazardous atmospheres, such as fuel trucks or carts transferring flammable materials. When properly clamped to ground, the static discharge reel dissipates static electrical buildup, reduced the chances of sparking and the potential for explosion.

**Features:**

- supplied with a 3/32" OD steel aircraft cable
- DC resistance is approximately one ohm per 50' of steel cable



Description	Stranded Steel Part #
single 7" x 7" stranded steel	<b>G3050</b>

## TFA Series Fill Pipe Adapter

**Feature:**

- for use with 3" drop elbows (**300-TFG**)

Adapter Size	Female NPT	Aluminum Hardcoat Part #	Optional Qty
3"	3"	<b>300-TFA</b>	10

## Fuel Delivery Tank Adapters



with NPSM thread



with NPT thread

**Features:**

- for use with 4" drop and co-axial elbows (6200, 6400 and 6500 series)
- **BZ4051S** has NPSM thread and is supplied with a gasket

Adapter Size	Female Thread	Height	Bronze Part #	Optional Qty
4"	4" NPSM	2 $\frac{3}{8}$ "	<b>BZ4051S</b>	5
	4" NPT	3 $\frac{1}{2}$ "	<b>BZ4051</b>	5

## Vapor Recovery Tank Adapters

**Features:**

- for use with dual point vapor elbows (VR6200 series)
- can also be used as vapor valve on tanker but does not have air interlock mount
- poppeted vapor collar at station vapor outlet
- low profile design
- replacement parts are available, contact Dixon® for more information

Adapter Size	Female Thread	Height	Material	Part #	Optional Qty
4"	4" NPT	3 $\frac{5}{8}$ "	bronze	<b>VR4086</b>	5
			ZN-AL alloy	<b>VR4086-BY</b>	5



## Vapor Caps

### Aluminum

**Features:**

- special locking cap for underground tank vapor outlet **VR4086** and tanker vapor valves
- bronze cam arms
- painted vapor recovery orange

Size	Aluminum Part #
4"	<b>VR4050AL</b>



### Nylon

**Features:**

- centered 'T' handle allows for one-handed use and provides a solid locking mechanism
- strong and lightweight
- built-in locking feature
- corrosion resistant materials
- vapor recovery orange
- replacement parts are available, contact Dixon® for more information

Size	Nylon Part #
4"	<b>VR4050PL</b>



## Automatic Pressure / Vacuum Relief Caps

**Features:**

- normally closed, stops fuel evaporation and airborne contaminants
- lockable
- relieves pressure and vacuum buildup in fuel tanks

Note: Pressure/vacuum relief caps should be routinely inspected to ensure correct operation and particularly to ensure that the relieving components are free to move and that the air flow path is unblocked.



### for stationary fuel tanks

**Feature:**

- relieves vacuum at .7 Hg (.33 PSI) and pressure at 2 PSI, 20 SCFM flow

Male NPT	Zinc Part #
2"	<b>2000L</b>
2½"	<b>2500L</b>



### for mobile fuel tanks

**Feature:**

- relieves vacuum at .33 Hg and pressure between 7.5 - 9 PSI

Male NPT	Zinc Part #
2"	<b>200-PV-9</b>



## Standard Vent Caps for Stationary Tanks

**Features:**

- allows venting of tank to atmosphere at all times
- also referred to as a breather cap
- does not have pressure or vacuum valves

Male NPT	<i>Aluminum</i> Part #
2½"	<b>2500SFV</b>

## Fuel Delivery Adapter Cap

**Features:**

- single action locking cap
- bronze cam arms
- replacement parts are available, contact Dixon® for more information

Size	<i>Aluminum</i> Part #	Optional Qty
4"	<b>SA4050AL</b>	10

## Swivel Joints

### Applications:

- used wherever a leak-proof swivel connection is needed in pipelines or in combination with hoses to eliminate hose twisting
- Industries range from petroleum, petrochemical, refining, mining, distilling, paint, farm irrigation and fertilizing, wastewater treatment plants and food and beverage process equipment. Dixon® swivel joints are found in blending plants, drum filling applications, fluid and dry bulk transfer, vacuum trucks, oil and gas trucks and water trucks. Larger swivels can be found in the steel industry, marine bulk transfer and many more.

### Features:

- full 360° rotational movement
- wide spacing between dual ball bearing raceways ensures greater load bearing capacity
- precision-machined design ensures alignment and years of trouble-free service
- O-ring dust seal protects the ball races and seals chamber from outside elements
- radius elbow design ensures a smooth flow pattern
- hydrostatic testing is performed on all swivels before shipment

### Options Available:

- end configurations: female NPT, 150# flanges, TTMA flange, grooved, weld end and many other variations
- seal options: Buna, FKM, PTFE, EPDM, FDA Buna, FFKM
- ball bearing materials: carbon steel, 440 stainless steel, and 316 stainless steel
- grease materials: Lithium, FDA approved/food grade and silicone
- swivels that include oxygen, steam or submerged service can be specifically designed for unique applications (special order)
- 100% full penetration weld
- re-build kits available
- custom swivel options available, contact Dixon® at 888.226.4673

Swivel configurator available [dixonvalve.com](http://dixonvalve.com)



## O-ring Parts Identification List

1. O-ring (dust) seal
2. ball retainer screw
3. O-ring (pressure) seal
4. grease fitting
5. ball bearings

### O-ring Features:

- sizes: 1" - 4"
- O-ring pressure seal ensures a leak-proof seal and smooth rotation with lower torque.
- available working pressure ratings up to 1000 PSI
- available in carbon steel, 316L stainless steel, aluminum, brass and malleable iron

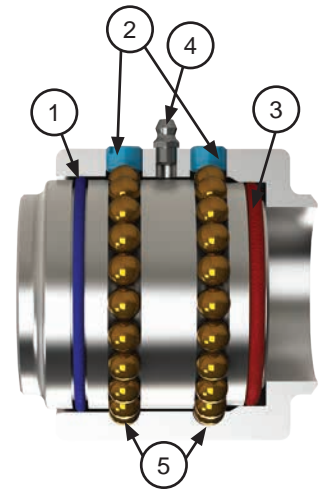

## V-ring Parts Identification List

1. body
2. sleeve
3. ball bearings
4. seal retainer
5. V-ring (pressure) seal
6. spring retainer
7. ball retainer screw
8. grease fitting
9. O-ring (dust) seal

### V-Ring Features:

- 2" - 12" size range
- spring loaded triple V-ring sealing system ensures a leak-proof seal at either high or low pressure and extends seal life
- available working pressure ratings up to 1000 PSI
- available in carbon steel, 316L stainless steel and limited aluminum

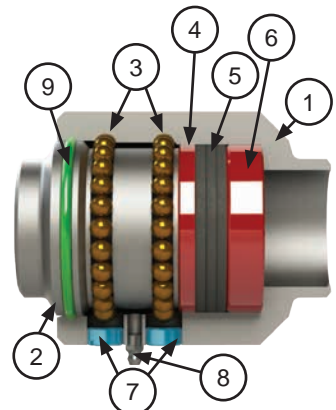

Swivels

Single Plane Style 20



female NPT x female NPT

Size	Aluminum Part #	Malleable Iron Part #
1½"	15020FXFAL00000	15020FXFMI00000
2"	220FXFAL00000	220FXFMI00000
3"	320FXFAL00000	320FXFMI00000
4"	420FXFAL00000	---

Single Plane Style 30



female NPT x female NPT

Size	Aluminum Part #	Malleable Iron Part #
1½"	15030FXFAL00000	15030FXFMI00000
2"	230FXFAL00000	230FXFMI00000
3"	330FXFAL00000	330FXFMI00000
4"	430FXFAL00000	---

Swivel Joint Styles Planes of Rotation

Single Plane Style 40



female NPT x female NPT



150# ASA flange x 150# ASA flange

Double Plane Style 50



female NPT x female NPT



150# ASA flange x 150# ASA flange

Double Plane Style 60



female NPT x female NPT



150# ASA flange x 150# ASA flange

Swivel configurator available [dixonvalve.com](http://dixonvalve.com)

## Swivel Joint Styles Planes of Rotation

## Double Plane Style 70



female NPT x female NPT



150# ASA flange x 150# ASA flange

## Triple Plane Style 80



female NPT x female NPT



150# ASA flange x 150# ASA flange

## Triple Plane Style 10



female NPT x female NPT

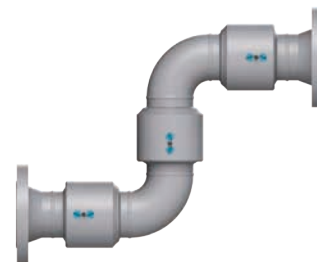

150# ASA flange x 150# ASA flange

## Working Pressures

Dixon® swivels are recommended for use at the following maximum Non-Shock Cold Working Pressures (NSCWP) provided in PSI, at ambient temperatures **70°F (21°C)**.

Size	V-ring Carbon Steel CS	O-ring Carbon Steel OC	V-ring Stainless Steel SS	O-ring Stainless Steel OS	Aluminum AL	Brass BR	Malleable Iron MI
1"	---	1000	---	1000	150	---	---
1¼"	---	---	---	---	150	---	---
1½"	---	1000	---	1000	150	300	600
2"	1000	1000	1000	1000	150	300	600
3"	1000	1000	1000	1000	150	300	600
4"	1000	---	1000	---	150	---	---
6"	1000	---	---	---	150	---	---
8"	---	---	---	---	150	---	---

- When using flanged ends, the pressure rating will be reduced to coincide with that of the flange being used. Carbon steel and stainless steel 150# flanges are recommended for use at **275 PSI** maximum at ambient temperature **70°F (21°C)**.
- Lubrication should be performed periodically, depending on service and operating conditions. Twice yearly is normally sufficient.
- All dimensions are approximate. Where critical, contact Dixon® at 888.226.4673

## Swivel Ordering Information

Size

Style (shape)

End configuration

Material

Maximum working pressure

Temperature range

Media: specify product being handled (if chemical, advise concentration)

Submerged or oxygen service

If for constant rotation, advise RPM

If for suction service, advise maximum vacuum in inches of mercury (Hg)

Our Sales and Engineering staff will help you evaluate your swivel application, please call 888.226.4673.

Example:  $\frac{2}{[A]}$   $\frac{20}{[B]}$   $\frac{F}{[C]}$  X  $\frac{F}{[C]}$   $\frac{CS}{[D]}$   $\frac{0}{[E]}$   $\frac{0}{[F]}$   $\frac{1}{[G]}$   $\frac{0}{[H]}$   $\frac{0}{[I]}$

A Size					
B Style					
C End Connections	W Weld End	F Female NPT	FG 150# ASA Flange	TF Tank Truck Flange	PF 300# ASA Flange (not available in aluminum)
D Material	CS (V-ring) Carbon Steel OC (O-ring) Carbon Steel	SS (V-ring) Stainless Steel OS (O-ring) Stainless Steel	AL Aluminum	BR Brass	MI Malleable Iron
Code	E Pressure Seal	F Dust Seal	G Retainers	H Ball Bearings	I Grease
0	Buna N (standard)	Buna N (standard)	no retainers (O-ring swivel)	carbon steel (Standard)	Lithium
1	FKM	FKM	PTFE (standard in CS V-ring) <sup>1</sup>	440 grade SS	FDA approved/ food grade
2	PTFE	---	PTFE (standard in SS V-ring)	316 grade SS	Silicone (required with EPR seals)
3	Ethylene Propylene	Ethylene Propylene	---	---	---
4	(requires silicone grease)	(requires silicone grease)	---	---	---

<sup>1</sup> Aluminum retainers are no longer available. PTFE retainers will be standard for all V-ring swivels.



The swivel should be packed such that the surfaces coming in contact with the fluid being handled are compatible with that fluid. In a case where the swivel is being used in a submerged service, this would include the dust seals and ball bearings. We always recommend the use of the stainless steel ball bearings when building a swivel for submerged service. Standard carbon steel ball bearings could rust together, making it impossible to disassemble the swivel and may affect operation.

Swivel configurator available [dixonvalve.com](http://dixonvalve.com)

## Loading Arm Swivels

## Features:

- TTMA loading arm swivel with heavy duty D style shovel handle
- TTMA flanges on both ends
- shovel handle is used to guide the API load coupler onto the adapter on the tank truck
- long radius elbow improves flow into the API load coupler and provides spacing between the load arm and the tank truck
- can be used with flange extensions on page 36

Size	Description	Aluminum Part #
4"	Style 30 short radius, with handle, Buna seals	<b>43HTFXTFAL00000</b>
	Style 30 short radius, with handle, FKM seals	<b>43HTFXTFAL11000</b>
	Style 30 short radius, without handle, Buna seals	<b>430TFXTFAL00000</b>
	Style 30 short radius, without handle, FKM seals	<b>430TFXTFAL11000</b>
	Style 30 long radius, with handle, Buna seals	<b>43HTFTFLAL00000</b>
	Style 30 long radius, with handle, FKM seals	<b>43HTFTFLAL11000</b>
	Style 30 long radius, without handle, Buna seals	<b>430FTFTFLAL00000</b>
	Style 30 long radius, without handle, FKM seals	<b>430FTFTFLAL11000</b>
	Style 40 with handle, Buna seals	<b>44HTFXTFAL00000</b>
	Style 40 with handle, FKM seals	<b>44HTFXTFAL11000</b>
	Style 40 without handle, Buna seals	<b>440TFXTFAL00000</b>
	Style 40 without handle, FKM seals	<b>440TFXTFAL11000</b>
	Style 50 with handle, Buna seals	<b>45HTFXTFAL00000</b>
	Style 50 with handle, FKM seals	<b>45HTFXTFAL11000</b>
	Style 50 without handle, Buna seals	<b>450TFXTFAL00000</b>
Style 50 without handle, FKM seals	<b>450TFXTFAL11000</b>	

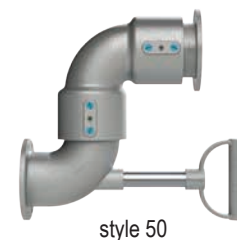
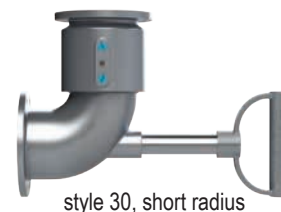

## Replacement Parts

Description	Part #
4" schedule 80 aluminum nipple	<b>ATN100X7</b>
D style heavy duty shovel handle	<b>100DHAN-AL</b>
ball handle	<b>100BHAN-AL</b>
buna seal kit	<b>4RKOBU</b>
FKM seal kit	<b>4RKOVIVI</b>



NEW

**NEW**

## Dixon® Loading Arms

**Applications:**

- used in the transfer of liquids and dry bulk in refineries, chemical plants, rail terminals, truck terminals, tote and drum filling and food industry

**Sizes:**

- 2", 3", 4" and more upon request

**Materials:**

- various materials available including: hardened carbon steel, 316L stainless steel and aluminum
- seals: Buna, EPDM, FKM A and B, PTFE, Baylast and more on request
- counterbalance housing: steel

**Features:**

- three options for sealing swivels: O-ring, V-ring and Split Flange
- fast delivery for many sizes and styles
- engineered with easy service in mind
- wide variety of end configurations available
- torsion spring counterbalance:
  - ball screw adjustment mechanism for easy and safe adjustment
  - multiple spring rates available for different load requirements
  - multiple grease ports for ease of service

Visit [dixonvalve.com/loadingarms](http://dixonvalve.com/loadingarms) for additional product information or call 888.226.4673.



## Split Flange Swivels

**Applications:**

- Used in petroleum, blending plants, petrochemical, refining, mining, distilling, paint plants, farm irrigation and fertilizing, wastewater treatment, food and beverage process equipment and marine

**Features:**

- bearing pack design allows easy seal change without removing the ball bearings
- simple maintenance: remove one nose piece, replace seal pack, reinstall with little down-time
- instream seal separates wetted area from ball bearings allowing for longer bearing pack life over conventional swivels
- pressure rating: up to **600 PSI**
- temperature: **-40°F to 450°F (-40°C to 232°C)** depending on seal material (with standard seals: **350°F (177°C)**)
- wide set bearing race for higher moment loads
- compact design for low profile applications

**Materials:**

- bearing pack: through hardened forged high carbon alloy
- material contact surfaces: stainless steel or carbon steel nose pieces

**Available options:**

- stock end configurations: 150 lb. and 300 lb. flanges, FNPT, butt weld, others per request
- stock seals: Baylast™, FKM, PTFE, others per request
- full penetration weld
- contact Dixon® at 888-226-4673 for additional materials and configurations

Size	Carbon Steel Weld x Weld with Baylast™ Pressure Seals	Carbon Steel Weld x Weld with FKM Pressure Seals	Carbon Steel 150# Flange x 150# Flange with Baylast™ Pressure Seals	Carbon Steel 150# Flange x 150# Flange with FKM Pressure Seals
2"	<b>SF220WXWCS00</b>	<b>SF220WXWCS10</b>	<b>SF220FGXFGCS00</b>	<b>SF220FGXFGCS10</b>
3"	<b>SF320WXWCS00</b>	<b>SF320WXWCS10</b>	<b>SF320FGXFGCS00</b>	<b>SF320FGXFGCS10</b>
4"	<b>SF420WXWCS00</b>	<b>SF420WXWCS10</b>	<b>SF420FGXFGCS00</b>	<b>SF420FGXFGCS10</b>

## Split Flange Swivel Components

## Split Flange Bearing Packs

**NEW**

Size	Carbon Steel Part #
2"	<b>2SFBP</b>
3"	<b>3SFBP</b>
4"	<b>4SFBP</b>



## Split Flange Nose Pieces

- 2 required per bearing pack

Size	Carbon Steel Part #	316 Stainless Steel Part #
2"	<b>2SFNPSC</b>	<b>2SFNPSS</b>
3"	<b>3SFNPSC</b>	<b>3SFNPSS</b>
4"	<b>4SFNPSC</b>	<b>4SFNPSS</b>



## Seal Kits

- kits contains: seal, PTFE retainer, carbon steel bolts
- 1 required per bearing pack

Size	Baylast Part #	FKM Part #	PTFE Part #
2"	<b>2SFSK-BAYLAST</b>	<b>2SFSK-VI</b>	<b>2SFSK-TESS</b>
3"	<b>3SFSK-BAYLAST</b>	<b>3SFSK-VI</b>	<b>3SFSK-TESS</b>
4"	<b>4SFSK-BAYLAST</b>	<b>4SFSK-VI</b>	<b>4SFSK-TESS</b>



## Railroad Tank Car Connections

**Features:**

- all swivel nuts have standard 5" Railroad Tank Car thread
- supplied with a Buna-N gasket in the threaded end, other gaskets available on page 59
- also available in other materials and in 2" and 2½" sizes, consult Dixon® for pricing and availability

**Style A**

Stainless steel railroad tank car connections are not compatible with aluminum and brass.



Male Adapter	Swivel Nut	Elbow	316 Stainless Steel Part #	Aluminum Part #
3"	5"	120°	<b>RTCA30</b>	---
4"	5"	110°	<b>RTCA40<sup>1</sup></b>	<b>ATCA40</b>

<sup>1</sup> parts are produced as a welded fabrication

**Style F****Features:**

- 4" TTMA flange can be bolted to sight glass; API adapter or other dry disconnect
- supplied with PTFE Buna-N envelope gasket



110° elbow

TTMA Flange	Swivel Nut	Elbow	Aluminum Part #
4"	5"	110°	<b>ATCF40<sup>1</sup></b>
	5"	90°	<b>ATCF40-90</b>

<sup>1</sup> part is produced as a welded fabrication

- For flange dimensions, diagrams and additional information please reference [dixonvalve.com](http://dixonvalve.com).

**Style GF****Feature:**

- 4" TTMA flange can be bolted to sight glass; API adapter or other dry disconnect



110° elbow

TTMA Flange	Boss-lock™ Coupler	Elbow	Aluminum Part #
4"	4"	110°	<b>ATCGF40</b>
	4"	90°	<b>ATCGF40-90</b>

- For flange dimensions, diagrams and additional information please reference [dixonvalve.com](http://dixonvalve.com).

**Screen****Features:**

- stainless steel screen encapsulated in a buna gasket
- for use in Style GF elbows



Size	Hole Size	316L Stainless Steel Part #
4"	1"	<b>400-G-BUSS</b>

**Style S**

Shank Size	Swivel Nut	Elbow	Aluminum Part #
4"	5"	110°	<b>ATCS40</b>

Railroad Tank Car Connections

Style T

Male NPT	Swivel Nut	Elbow	Iron Part #	Aluminum Part #
3"	5"	120°	<b>TCT30</b>	<b>ATCT30</b>
4"	5"	110°	<b>TCT40</b>	<b>ATCT40</b>



Style T

Components that make up these assemblies are not interchangeable between stainless steel and the other materials. 

Male NPT	Swivel Nut	Elbow	316 Stainless Steel Part #
3"	5"	120°	<b>RTCT30</b>
4"	5"	110°	<b>RTCT40</b>



Dixon® Coupler x Tank Car Thread

Features:

- part is produced as a welded fabrication
- pressure rating is based on the seal of the mating part, see ratings on page 124
- use Dixon® replacement handles only

Coupler	Male Tank Car Thread	Aluminum Part #
4"	5"	<b>400DWX5TC</b>



EZ Boss-Lock™ x Coupler Tank Car Thread

Features:

- part is produced as a welded fabrication
- pressure rating is based on the seal of the mating part, see ratings on page 124
- use EZ Boss-Lock™ replacement handles only

Coupler	Male Tank Car Thread	Aluminum Part #
4"	5"	<b>AD400ALEZMTC</b>



## Railroad Unloading Assemblies

**Features:**

- robust aluminum body construction
- removable, easy carry handle
- safe and reliable - valves will not open unless fittings are properly connected
- multiple configurations available, consult Dixon™ for pricing and availability

**Assembly with MannTek Dry Disconnect Adapter**

Adapter Size	Swivel Nut Size	Aluminum Part #
4"	5"	<b>ATC40ASSDDA</b>

**Assembly with API Adapter****Feature:**

- stainless steel springs on the adapter and coupler for corrosion resistance

Adapter Size	Swivel Nut Size	Aluminum Part #
4"	5"	<b>ATC40ASSAPI</b>

## Dixon® Tank Car Adapters



rocker lug



pin lug



Stainless steel adapters are not compatible with the aluminum and brass adapters.

**Features:**

- standard 5" Railroad Tank Car thread
- supplied with a Buna-N gasket in the threaded end, see next page for more gaskets

Size	356T6 Aluminum Part #	Brass Part #	Iron Part #	316 Stainless Steel Part #
2"	<b>200-TCA-AL</b>	---	---	<b>200-TCA-SS</b>
3"	<b>300-TCA-AL</b>	<b>300-TCA-BR</b>	<b>300-TCA-MI</b>	<b>300-TCA-SS</b>
4"	<b>400-TCA-AL</b>	<b>400-TCA-BR</b>	---	<b>400-TCA-SS</b>

**45° Swivel****Features:**

- standard 5" Railroad Tank Car thread
- 45° tank car swivel adapter
- unit has a long handle brass swivel nut and a swivel retaining ring
- supplied with a Buna-N gasket in the threaded end, see next page for more gaskets

Size	356T6 Aluminum Part #
4"	<b>40A-45TCAL</b>

Note: 4" hose fittings for railroad tank car unloading can be found on pages 55 and 56.

## Cam & Groove Railroad Tank Car Gaskets

### Old Style

**Feature:**

- for use with Dixon® fittings

Size	OD	ID	Thick	Leather Part #
5"	5¼"	3½"	3/16"	<b>G9</b>



### Standard

**Feature:**

- for use with Dixon® fittings

Size	OD	ID	Thick	Material	Part #
5"	5¼"	3⅞"	⅛"	<i>Buna-N</i>	<b>500GTCABU</b>
	5¼"	3⅞"	⅛"	<i>FKM</i>	<b>500GTCAVI</b>
	5¼"	3⅞"	⅛"	<i>fuel grade Buna</i>	<b>500GTCABF</b>
	5-5/16"	3⅞"	3/16"	<i>FKM</i>	<b>500GTCAVITHK</b>



### PTFE Envelope

**Features:**

- for use with Dixon® fittings
- may be too thick for insertion in some older Dixon® fittings

Size	OD	ID	Thick	Material	Part #
5"	5¼"	3-13/16"	3/16"	<i>PTFE with Buna-N filler</i>	<b>500GTCATF</b>
	5¼"	3-13/16"	3/16"	<i>PTFE with FKM filler</i>	<b>500GTCATV</b>



## Pin Lug Wrench

**Feature:**

- used on aluminum and iron tank car nuts

Iron Part #
<b>G10</b>



## Bronze Sight Flow Indicators

Female NPT x Female NPT

Stock Quantity Only

## Features:

- verifies flow and monitors color and clarity in fluid lines
- double window snap ring design
- bronze body
- ABS indicator
- tempered soda lime sight glass
- Buna-N seals
- maximum operating pressure: **125 PSI**
- maximum temperature: **200°F (93°C)**
- made in the USA



Size	Overall Length	Width	Height	Bronze Part #	Optional Qty
½"	3-13/16"	2-7/16"	2-7/16"	<b>SF1631-050</b>	1
¾"	3-13/16"	2-7/16"	2-7/16"	<b>SF1631-075</b>	1
1"	4-3/8"	3"	3-1/8"	<b>SF1631-100</b>	1
1½"	4-5/8"	3-13/16"	4"	<b>SF1631-150</b>	1
2"	4-5/8"	3-13/16"	4"	<b>SF1631-200</b>	1

## Stainless Steel Sight Flow Indicators

Female NPT x Female NPT

Stock Quantity Only

## Features:

- verifies flow and monitor color and clarity in fluid lines
- radial sealing method and bolt-on body design provide reliable service with no torquing maintenance required
- white acetal resin, 40% glass filled propeller style indicator is standard and best for observations at a distance or with opaque liquids <sup>1</sup>
- tempered soda lime sight glass <sup>2</sup>
- FKM seals are standard <sup>3</sup>
- maximum operating pressure: **200 PSI at 150°F (66°C)**
- maximum temperature: **225°F (107°C) at 150 PSI**
- made in the USA
- 150# flanged units and other metals are available, consult Dixon® for price and availability.



½"



1½"



2"

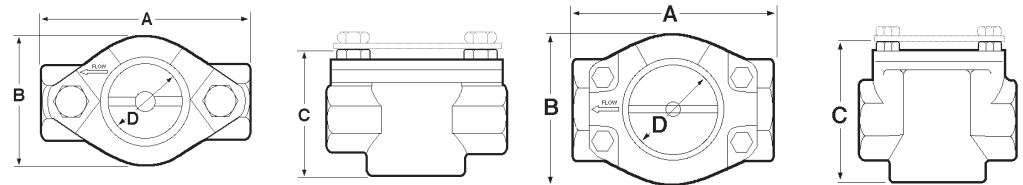

Size	Overall Length A	Width B	Height C	Diameter of Sight Opening D	Stainless Steel Part #	Optional Qty
½"	3¼"	2"	2-3/8"	1⅞"	<b>SF1471-050</b>	1
¾"	4¼"	2-9/16"	3-1/4"	1½"	<b>SF1471-075</b>	1
1"	4¼"	2-9/16"	3-1/4"	1½"	<b>SF1471-100</b>	1
1½"	5⅝"	3-5/16"	4-5/16"	2"	<b>SF1471-150</b>	1
2"	5⅝"	3-5/16"	4-5/16"	2"	<b>SF1471-200</b>	1

<sup>1</sup> Plain, flapper or drip tube style indicators are available as are PTFE indicators, consult Dixon® for price and availability.

<sup>2</sup> Special units with tempered borosilicate glass are available, consult Dixon® for price and availability.

<sup>3</sup> PTFE, EPR and Buna-N seals are available, consult Dixon® for price and availability.

## ADS Outalarms

Automated Design Service, Inc. (ADS) is now operating as Dixon® Industrial Fluid Control to manufacture products specifically designed for liquid terminal operations. Our standard product offering is shown on the following pages. However, there are numerous additional applications, materials and custom designs available, please visit [dixonvalve.com/ADS](http://dixonvalve.com/ADS) for the latest information. Call 513.874.8499 or 877.582.3569 for technical information or assistance with ordering these products.

### ADS Outalarms with Probe

**Application:**

- specifically designed for liquid terminal operation on batch loading and overfill protection, unloading, tank cars, tanks trucks, marine barges, suitable for open and closed dome

**Features:**

- totally self-contained; no wires, tubing or external power
- rugged weather and corrosion resistant construction
- no moving parts, tip sensitive phase shift™ digital capacitance sensor for conductive and non-conductive fluid
- intrinsically safe design per ANSI/UL913 for Class I, Div I Groups A, B, C and D Hazardous Areas
- requires no calibration or adjustment
- operates up to 2500 hours on a single 9V alkaline battery
- adjustable insertion length through a standard ½" NPT fitting
- high intensity audible and flashing visual outputs
- full, hard graduated laser engraved rod
- fail safe continuous battery monitor goes to alarm state on low battery
- factory tuned to trip ¼" into liquid
- 24", 36", 48" and 60" probe lengths standard, other lengths available
- battery current drain <0.23 ma during standby; <50 ma in alarm state
- horn intensity 101 dB at 2'
- light output 3 each 3000 mcd high intensity flashing LED's
- wetted materials: 316 stainless steel, PTFE standard, other materials available
- pressure rating on standard unit: **50 PSI**, consult Dixon® for applications up to 300 PSI
- optional opto-isolated solid state contact output
- high temperature applications to **325°F (162°C)**
- low temperature option good to **-40°F (-40°C)**
- temperature range: **-14°F to 325°F (-26°C to 163°C)**

### ADS Outalarms with A100 Probe

**Features:**

- capacitance Phase Shift probe
- ½" NPT gland standard
- minimum dielectric constant 1.8
- temperature range: **-14°F to 250°F (-26°C to 121°C)**



Length	Capacitance 250°F (121°C) maximum	Hi-temp Capacitance 325°F (163°C) maximum	Conductivity for conductive fluids
12"	<b>A100C12A</b>	<b>A100HC12A</b>	<b>A100CSS12A</b>
24"	<b>A100C24A</b>	<b>A100HC24A</b>	<b>A100CSS24A</b>
36"	<b>A100C36A</b>	<b>A100HC36A</b>	<b>A100CSS36A</b>
48"	<b>A100C48A</b>	<b>A100HC48A</b>	<b>A100CSS48A</b>
60"	<b>A100C60A</b>	<b>A100HC60A</b>	<b>A100CSS60A</b>
72"	<b>A100C72A</b>	<b>A100HC72A</b>	<b>A100CSS72A</b>
84"	<b>A100C84A</b>	<b>A100HC84A</b>	<b>A100CSS84A</b>



## ADS 210 Spillguard™ Monitors

**Application:**

- shutdown system for tank cars, tank trucks, barges and ships, suitable for open and closed dome

**Features:**

- rugged, explosion proof, weather, chemical and corrosion resistant
- LED status lights visible through glass cover
- inserts into tank through standard ½" NPT fitting
- probe can be portable or permanently installed in the vessel
- laser engraved graduated rod with ¼" graduations
- probe-to-controller cable protected by stainless steel interlocking armor sheath and heavy duty latching connectors at both ends
- fail safe design, unit trips in the event of an open or shorted cable or loss of power
- controller housing NEMA 4X, NEMA 7, Explosion Proof, Class I, II, Groups B, C and D
- choice of capacitance, conductivity, ultrasonic, temperature or float sensors
- insertion lengths 4" to 60" standard, other lengths available
- wetted materials: 316 stainless steel and PTFE standard, other materials available
- sensor suitable for Class I, II, III, Div 1, Groups A, B, C and D when used with supplied controller and cable lengths of 10,000' or less
- input power: 120 VAC, 240 VAC or 24 VDC, 2.5 watts
- output relay contacts 2 form C (2PDT) rated 2 amps at 120/240 VAC, 1 form C (SPDT) with optional latching circuit and reset switch
- output relay de-energizes on high level, broken or shorted sensor cables or loss of power
- sensor excitation open circuit voltage 8 VDC, short circuit current 8 MA with built-in FM approved barrier
- probe temperature range: **-14°F to 212°F (-26°C to 100°C)**
- probe pressure rating: **50 PSI** with standard fitting, consult Dixon® for applications up to 300 PSI
- standard cable lengths: 15', 25' and 50', other lengths available
- cable connectors designed for repeated mating meet IP 65 mechanical and environmental specifications
- optional self test feature, tilt and ground verification interlocks and latching circuit available



Monitor Options	24V DC	120V AC
A210 Spillguard™ monitor	<b>A210-24</b>	<b>A210-120</b>
with bypass timer	<b>A210B-24</b>	<b>A210B-120</b>
with external reset switch	<b>A210R-24</b>	<b>A210R-120</b>



## ADS Spillguard™ Probes

### Capacitance Probes

**Application:**

- for materials with dielectric constant > 1.8, liquids, powders, slurries

**Materials:**

- probe: 316 stainless
- housing: NEMA 4X, IP66

**Features:**

- ½" NPT sliding fitting standard, ¾" fitting optional
- open dome adapter and washout fitting available
- tilt sensor optional

**Specifications:**

- capacitance probe: **250°F (121°C)** maximum
- high temperature probe: **325°F (163°C)** maximum

Length	Capacitance	
	Capacitance	High-Temp
12"	<b>A200PC12A</b>	<b>A200PHC12A</b>
24"	<b>A200PC24A</b>	<b>A200PHC24A</b>
36"	<b>A200PC36A</b>	<b>A200PHC36A</b>
48"	<b>A200PC48A</b>	<b>A200PHC48A</b>
60"	<b>A200PC60A</b>	<b>A200PHC60A</b>
72"	<b>A200PC72A</b>	<b>A200PHC72A</b>
84"	<b>A200PC84A</b>	<b>A200PHC84A</b>

### Conductivity Probes

**Application:**

- for conductive fluids such as acids and water based mixtures

**Materials:**

- probe: 316 stainless, Hastelloy available for HCL service
- housing: NEMA 4X, IP66

**Features:**

- ½" NPT sliding fitting standard, ¾" fitting optional
- open dome adapter and washout fitting available
- pressure and tilt sensor options
- single electrode protected in housing
- dual electrodes exposed for easy cleaning

Length	Conductivity	
	Single Electrode	Dual Electrode
12"	<b>A200PCSS12A</b>	<b>A200PCSSDP12A</b>
24"	<b>A200PCSS24A</b>	<b>A200PCSSDP24A</b>
36"	<b>A200PCSS36A</b>	<b>A200PCSSDP36A</b>
48"	<b>A200PCSS48A</b>	<b>A200PCSSDP48A</b>
60"	<b>A200PCSS60A</b>	<b>A200PCSSDP60A</b>
72"	<b>A200PCSS72A</b>	<b>A200PCSSDP72A</b>
84"	<b>A200PCSS84A</b>	<b>A200PCSSDP84A</b>

### Float Probes

**Application:**

- for use with foaming, very low density, or highly viscous liquids

**Materials:**

- probe: 316 stainless, Hastelloy available for HCL service
- housing: NEMA 4X

**Features:**

- single point standard, dual or multi-level float available
- open dome adapter and washout adapter available
- A100 battery powered monitor

Length	A100	A200
	Outalarm Float Probe	Float Probe
24"	<b>A100F24DA</b>	<b>A200F24DA</b>
36"	<b>A100F36DA</b>	<b>A200F36DA</b>
48"	<b>A100F48DA</b>	<b>A200F48DA</b>

### Multi-Point Ultrasonic Probes

**Application:**

- for use when multiple detection points are required such as dribble mode, pump shutoff and overflow alarm

**Features:**

- up to 5 sense points available
- pressure sensor
- ground verification
- tilt storage probe only active in vertical operational position
- Built special order to customer specifications, contact Dixon Bayco at 513.874.8499 for more information.

## ADS Outage Gauge

**Applications:**

- set level fill point for manual / visual fill control
- measure outage requirements on mobile tanks

**Feature:**

- open dome bracket

Length	316 stainless steel Standard Outgauge Part #	316 stainless steel Outgauge with J Bar Part #
2'	<b>A800OG2</b>	<b>A800OGJ2</b>
3'	<b>A800OG3</b>	<b>A800OGJ3</b>
4'	<b>A800OG4</b>	<b>A800OGJ4</b>
5'	<b>A800OG5</b>	<b>A800OGJ5</b>

## ADS Gauge Rods

**Application:**

- used to gauge liquid levels in any mobile tank

**Features:**

- ½" x .065 wt hardened 316 stainless steel
- laser engraved scale with ¼" graduations
- rods come in two sections that screw together at the midpoint
- foot marks inscribed on rod at 1' intervals below the inch mark
- heavy duty plastic handle
- available in 4', 8' and 12' lengths

Description	316 Stainless Steel Part #
4'	<b>ADS4GR</b>
8'	<b>ADS8GR</b>
12'	<b>ADS12GR</b>



laser engraving closeup

## ADS Spillguard™ Armored Cables

**Features:**

- 3 or 5 pin connector
- 316 stainless steel armoured cable or yellow rubber cable
- custom lengths available, call 513.874.8499 or 877.582.3569 for more information

**Armored Cables**

Length	3 Pin	5 Pin
15'	<b>A200CA3P15</b>	<b>A200CA5P15</b>
20'	<b>A200CA3P20</b>	<b>A200CA5P20</b>
25'	<b>A200CA3P25</b>	<b>A200CA5P25</b>
50'	<b>A200CA3P50</b>	<b>A200CA5P50</b>

**Rubber Cable <sup>1</sup>**

Length	3 Pin
25'	<b>A200CB3P25</b>

<sup>1</sup> for use with (-M) mini connectors only

Accessories

ADS Open Dome Adapters

Features:

- flexible design fits most domes
- 1/2" and 3/4" NPT port for Outalarm probes

<i>Stainless Steel</i>
Part #
<b>A100DA</b> <span style="color: red; font-weight: bold; border: 1px solid red; padding: 2px;">NEW</span>
<b>A100DB</b>



A100DA

Tank Washout Caps

Description	Part
tank truck 3" wash-out adapter, 1/2" NPT	<b>A100TTA</b>
tank truck 3" wash-out adapter, 3/4" NPT	<b>A100TTB</b>
washout cap with swivel	<b>A200SA</b>
washout cap with swivel and 2" vent	<b>A200SVA</b>



A100TTA



A200SA

Cable Junction Boxes

Description	Part
3 pin	<b>A210CR-3</b>
5 pin	<b>A210CR-5</b>



A210CR-3

Additional Parts & Accessories

Description	Part
1" cam and groove coupler and 1/2" NPT bushing, stainless steel	<b>A100CA1050</b>
1" cam and groove coupler with 1/2" NPT busing and 1" NPT vent tee, stainless	<b>A100CA1050V</b>
A100 / 200 splash guard, with 1 1/8" diameter poly	<b>A100SG-POLY</b>
locating tab for A100 / 200 probes	<b>A100LT</b>
replacement A100 monitor only	<b>A100MTR</b>
cable to monitor adapter	<b>A100CBLMTR</b>
A210 Piezo horn 24VDC	<b>A210PZH-24</b>
tri color external signal light	<b>A210-120TC</b>



A210PZH-24



A210-12TC

<b>Boss™ System</b> .....	<b>67 to 77</b>	<b>Holedall™</b> .....	<b>85 to 106</b>
Ground joint .....	67 to 69	Coupling machines .....	85
Complete female .....	67	Recommended working pressure .....	86
Stems .....	67	External swage .....	87 to 92
Wing nuts .....	68	Stems .....	88 to 89
Knurled nut .....	68	Flange assembly .....	89
Female spuds .....	68	Female ends .....	90
Male spuds .....	69	Uni-range male couplings .....	90
Double spuds .....	69	Ferrules .....	91, 92
Boss Holedall™ fittings .....	69	Internal swage .....	93 to 98
NPT adapters .....	70	Stems .....	93, 94
Wing nut caps .....	70	Ferrules .....	94
Washer seals .....	71 to 72	Scovill style .....	95 to 96
Complete female .....	71	API Certified permanently attached .....	97 to 98
Stems .....	71	Washers .....	99
Female spuds .....	71	HB coupling expander machine .....	99
Male spud .....	72	Permanent pump hose couplings .....	99
Double spuds .....	72	Dubl-grip® re-attachable couplings .....	100
Seal washers .....	72	CIP internal expansion sanitary style .....	101
Male stems .....	73	Sanitary style .....	101 to 106
LP Boss™ male stems .....	74	Stems .....	101, 102
Hose menders .....	74	Plugs .....	101
Spud x hose shank .....	74	Threaded hex nuts .....	102
Clamps .....	75 to 76	Flow Chief ferrules .....	103
Ground joint air hammer .....	77	Sanitary King Crimp™ stems .....	104 to 105
Stems .....	77	DIN external crimp stems .....	106
Wing nuts .....	77	Sanitary style crimp ferrules .....	106
Spuds .....	77		
		<b>King Crimp™</b> .....	<b>107 to 119</b>
<b>Boss™ LPS frac fittings</b> .....	<b>78 to 84</b>	Crimp working pressure chart .....	107
Complete male/female assemblies .....	78	Type C .....	108
Females .....	78	Type E .....	109
Males with nut .....	79	Global type C .....	109
Suction service .....	79	Global type E .....	110
O-ring .....	79	Boss™ ground joint stems .....	110
King Crimp™ style short ferrules .....	79	Sleeves .....	111 to 112
One and two piece hammer union nuts .....	80	Ferrules .....	113 to 114
Hammer union caps and plugs .....	81	Nipples .....	115, 116, 117
One-piece flange adapters .....	82, 83	150# ASA fixed flanges .....	116
Straights .....	82	Nipples x TTMA flange .....	116
Shorts .....	82	Nipple for floating flange .....	116
Elbows .....	82	Short combination nipples .....	117
Flange to weld adapters .....	83	Short ferrules .....	117
Flange x male NPT .....	83	Large sleeves .....	117
Port adapter .....	83	Heavy duty nipples .....	118
Hammer union elbows .....	83	Heavy duty ferrules .....	118
Hammer union elbows .....	83		
Boss LPS™ System Components .....	84		

**Features:**

- positive metal-to-polymer seal
- leakproof seal forms when the metal head of the stem makes contact with the patented polymer seat in the spud
- non-metallic polymer seat resists most chemicals found in manufacturing facilities (reference corrosion resistance chart on pages 921 - 926)
- recommended for steam service up to **450°F (232°C)**
- easy to seal
- use with Boss™ clamps found on pages 75, 76

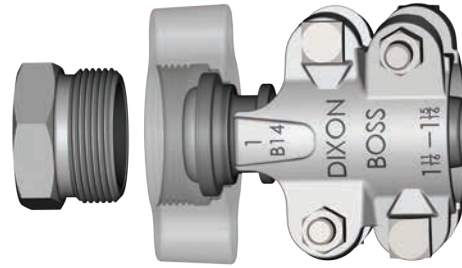
**Boss™ Ground Joint Couplings with Female Spud**

Hose Shank x NPT	Plated Steel and / or Iron Part #	316 Stainless Steel Part #	Brass Part #
1/4"	<b>GF1</b> <sup>1</sup>	---	---
3/8"	<b>GF3</b> <sup>1</sup>	---	---
1/2"	<b>GF6</b>	---	---
1/2" x 3/4"	<b>GF26-1</b>	---	---
3/4"	<b>GF26</b>	<b>RGF26</b>	<b>BGF26</b>
1"	<b>GF36</b>	<b>RGF36</b>	<b>BGF36</b>
1 1/4"	<b>GF51</b>	<b>RGF51</b>	---
1 1/2"	<b>GF61</b>	<b>RGF61</b>	---
2"	<b>GF81</b> <sup>2</sup>	<b>RGF81</b> <sup>2</sup>	---
2 1/2"	<b>GF96</b>	---	---
3"	<b>GF111</b>	---	---
4"	<b>GF141</b>	---	---
6"	<b>GF201</b> <sup>1</sup>	---	---

<sup>1</sup> 1/4", 3/8" and 6" available only with copper seat spuds

<sup>2</sup> not to be used with #250, #275 or #306 Boss™ clamps

**Boss™ Ground Joint Stems**

Hose Shank x NPT	Plated Steel and / or Iron Part #	Optional Qty	316 Stainless Steel Part #	Brass Part #
1/4"	<b>GBA</b>	100	---	---
3/8"	<b>GCA</b>	100	---	---
1/2"	<b>GB1</b>	100	---	---
1/2" x 3/4"	<b>GB6-1</b>	50	---	---
3/4"	<b>GB6</b>	50	<b>RGB6</b>	<b>BGB6</b>
1"	<b>GB11</b>	50	<b>RGB11</b>	<b>BGB11</b>
1 1/4"	<b>GB16</b>	25	<b>RGB16</b>	---
1 1/2"	<b>GB21</b>	25	<b>RGB21</b>	---
2"	<b>GB26</b> <sup>2</sup>	10	<b>RGB26</b> <sup>1</sup>	---
2 1/2"	<b>GB31</b>	5	---	---
3"	<b>GB36</b> <sup>2</sup>	5	---	---
4"	<b>GB46</b>	5	---	---
6"	<b>GB66</b>	2	---	---

<sup>1</sup> not to be used with #250, #275 or #306 Boss™ clamps

<sup>2</sup> GB26 / GB36 have machined shank to accept Boss™ clamps, King Crimp™ sleeves, ferrules. Use only Boss clamps on GB26 / GB36 for steam service.



**Only use the crimp style shanks with the crimp style sleeves and ferrules.**

Due to differences in dimensions and tolerances for safety reasons, do not interchange other manufacturer's products with Dixon® products. Pressure rating is based on the seal of the mating part. Reference [dixonvalve.com](http://dixonvalve.com) for a complete list of ratings.

The King Crimp™ sleeve and ferrule are not intended for steam service.

Boss™ Wing Nuts



plated iron / steel



316 stainless steel



brass

Size	Plated Steel and / or Iron Part #	Optional Qty	316 Stainless Steel Part #	Brass Part #
1/4"	<b>SLS4</b>	100	---	---
3/8"	<b>CB</b>	100	---	---
1/2"	<b>B2</b>	100	---	---
3/4"	<b>B12</b>	25	<b>RB12</b>	<b>BB12</b>
1"	<b>B12</b>	25	<b>RB12</b>	<b>BB12</b>
1 1/4"	<b>B17</b>	25	<b>RB17</b>	---
1 1/2"	<b>B17</b>	25	<b>RB17</b>	---
2"	<b>B27</b>	10	<b>RB27</b>	---
2 1/2"	<b>B32</b>	5	---	---
3"	<b>B37</b>	5	---	---
4"	<b>B47</b>	5	---	---
6"	<b>B67</b>	2	---	---

Boss™ Knurled Nut



Size	Plated Steel Part #	Optional Qty
3/4" and 1"	<b>KB12</b>	25

Boss™ Ground Joint Female Spuds

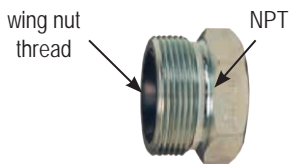

Thread	Plated Steel and / or Iron Part #	Optional Qty	316 Stainless Steel Part #	Brass Part #
1/4"	<b>GBC</b> <sup>1</sup>	100	---	---
3/8"	<b>GCC</b> <sup>1</sup>	100	---	---
1/2"	<b>GB3</b>	100	---	---
3/4"	<b>GB8</b>	50	<b>RGB8</b>	<b>BGB8</b>
1"	<b>GB13</b>	50	<b>RGB13</b>	<b>BGB13</b>
1 1/4"	<b>GB18</b>	25	<b>RGB18</b>	---
1 1/2"	<b>GB23</b>	25	<b>RGB23</b>	---
2"	<b>GB28</b>	10	<b>RGB28</b>	---
2 1/2"	<b>GB33</b>	5	---	---
3"	<b>GB38</b>	5	---	---
4"	<b>GB48</b>	5	---	---
6"	<b>GB68</b> <sup>1</sup>	2	---	---

<sup>1</sup> 1/4", 3/8" and 6" available only with copper seat spuds, all other sizes have polymer seats

## Boss™ Ground Joint Male Spuds

Thread	Plated Steel Part #	Plated Iron Part #
3/8"	<b>GMC<sup>1</sup></b>	---
1/2"	<b>GM3</b>	---
3/4"	<b>GM8</b>	---
1"	<b>GM13</b>	---
1 1/4"	---	<b>GM18</b>
1 1/2"	---	<b>GM23</b>
2"	---	<b>GM28</b>
2 1/2"	---	<b>GM33</b>
3"	---	<b>GM38</b>

Hose Coupling  
Systems

<sup>1</sup> 1/4", 3/8" and 6" available only with copper seat spuds, all other sizes have polymer seats

## Boss™ Ground Joint Double Spuds

Thread	Plated Steel Part #	Plated Iron Part #
1/2"	<b>GDB3</b>	---
3/4" and 1"	<b>GDB13</b>	---
1 1/4" and 1 1/2"	---	<b>GDB23</b>
2"	---	<b>GDB28</b>
2 1/2"	---	<b>GDB33</b>
3"	---	<b>GDB38</b>

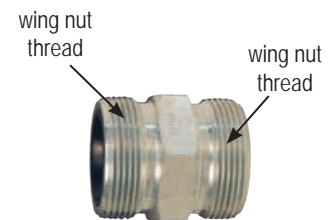

B

## Boss Holedall™ Fittings

## Applications:

- designed for air and liquid applications where a permanent, low profile clamping system is desired
- *not for steam service* 

## Features:

- supplied with carbon steel ferrules
- consult Dixon® for swage and/or crimp specifications

Size	Hose OD		Plated Iron / Steel Part #	Stainless Steel Part #
	From	To		
3/4"	1-10/64"	1-14/64"	<b>GF26P1</b>	---
	1-15/64"	1-18/64"	<b>GF26P2</b>	---
	1-19/64"	1-22/64"	<b>GF26P3</b>	---
1"	1-30/64"	1-34/64"	<b>GF36P1</b>	---
	1-35/64"	1-38/64"	<b>GF36P2</b>	---
	1-39/64"	1-42/64"	<b>GF36P3</b>	---
1 1/2"	1-58/64"	2"	<b>GF61P1</b>	<b>RGF61P1</b>
	2-1/64"	2-8/64"	<b>GF61P2</b>	<b>RGF61P2</b>
	2-9/64"	2-16/64"	<b>GF61P3</b>	---
2"	2-28/64"	2-40/64"	<b>GF81P1<sup>1</sup></b>	<b>RGF81P1</b>
	2-41/64"	2-48/64"	<b>GF81P2<sup>1</sup></b>	<b>RGF81P2</b>
	2-49/64"	2-56/64"	<b>GF81P3<sup>1</sup></b>	---
3"	3-30/64"	3-40/64"	<b>GF111P1<sup>1</sup></b>	---
	3-41/64"	3-48/64"	<b>GF111P2<sup>1</sup></b>	---
	3-49/64"	3-56/64"	<b>GF111P3<sup>1</sup></b>	---

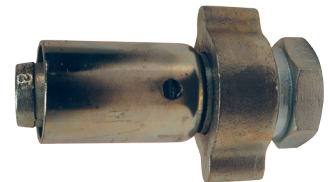

<sup>1</sup> 2" and 3" have a machined shank

## Boss™ Adapters

## Female NPT

## Features:

- designed to fit the standard ground joint spuds on pages 68, 69
- supplied with a wing nut, as shown
- for safety tags and safety tape, see page 910



Size	NEW	
	Plated Steel and / or Iron Part #	316 Stainless Steel Part #
¾"	<b>GFAS6</b>	<b>RGFAS6</b>
1"	<b>GFAS11</b>	<b>RGFAS11</b>
1¼"	<b>GFAS16</b>	---
1½"	<b>GFAS21</b> <sup>1</sup>	---
2"	<b>GFAS26</b>	---
3"	<b>GFAS36</b>	---

<sup>1</sup> part is produced as a welded fabrication

## Male NPT



Size	NEW	
	Plated Steel and / or Iron Part #	316 Stainless Steel Part #
¾"	<b>GMAS6</b>	<b>RGMAS6</b>
1"	<b>GMAS11</b>	---
1¼"	<b>GMAS16</b>	---
1½"	<b>GMAS21</b>	---
2"	<b>GMAS26</b> <sup>1</sup>	---
3"	<b>GMAS36</b>	---

<sup>1</sup> uses a special wing nut, part # B27-1

## Boss™ Wing Nut Caps

## Features:

- supplied with 12" chain and washer
- for best results, use with washer style spuds and washers on page 72
- not intended for pressure applications 



Size	Plated Steel and / or Iron Part #	316 Stainless Steel Part #	Opt Qty
¾" and 1"	<b>B12SC</b>	<b>RB12SC</b>	25
1¼" and 1½"	<b>B17SC</b>	---	25
2"	<b>B27SC</b>	---	10
3"	<b>B37SC</b>	---	5



**Features:**

- recommended for steam service up to **450°F (232°C)**
- easy to seal
- Klingersil® C-4401 washer is inserted between the stem and spud
- leakproof seal forms by rotating the wing nut and hammering it tight
- use with Boss™ clamps found on pages 75 - 76
- use with wing nuts found on page 68

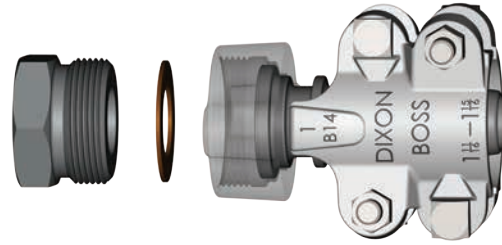
**BOSS™ Washer Seal Couplings with Female Spud**

Hose Shank x NPT	Plated Steel and / or Iron Part #	316 Stainless Steel Part #
3/8"	<b>WF3</b>	---
1/2"	<b>WF6</b>	---
1/2" x 3/4"	<b>WF26-1</b>	---
3/4"	<b>WF26</b>	<b>RWF26</b>
1"	<b>WF36</b>	<b>RWF36</b>
1 1/4"	<b>WF51</b>	<b>RWF51</b>
1 1/2"	<b>WF61</b>	<b>RWF61</b>
2"	<b>WF81</b> <sup>1</sup>	<b>RWF81</b> <sup>1</sup>
2 1/2"	<b>WF96</b>	---
3"	<b>WF111</b>	---

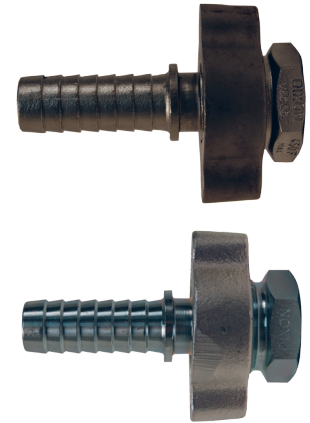
<sup>1</sup> not to be used with #250, #275 or #306 Boss™ clamps**BOSS™ Washer Seal Stems**

Hose Shank x NPT	Plated Steel and / or Iron Part #	Opt Qty	316 Stainless Steel Part #
3/8"	<b>SS337</b>	100	---
1/2"	<b>B1</b>	100	---
1/2" x 3/4"	<b>B6-1</b>	50	---
3/4"	<b>B6</b>	50	<b>RB6</b>
1"	<b>B11</b>	50	<b>RB11</b>
1 1/4"	<b>B16</b>	25	<b>RB16</b>
1 1/2"	<b>B21</b>	25	<b>RB21</b>
2"	<b>B26</b> <sup>1</sup>	10	<b>RB26</b> <sup>1</sup>
2 1/2"	<b>B31</b>	5	---
3"	<b>B36</b>	5	---

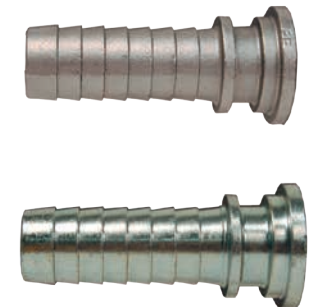
<sup>1</sup> not to be used with #250, #275 or #306 Boss™ clamps**BOSS™ Washer Seal Female Spuds**

Thread Size	Plated Steel and / or Iron Part #	Opt Qty	316 Stainless Steel Part #
3/8"	<b>CC</b>	100	---
1/2"	<b>B3</b>	100	---
3/4"	<b>B8</b>	25	<b>RB8</b>
1"	<b>B13</b>	50	<b>RB13</b>
1 1/4"	<b>B18</b>	25	<b>RB18</b>
1 1/2"	<b>B23</b>	25	<b>RB23</b>
2"	<b>B28</b>	10	<b>RB28</b>
2 1/2"	<b>B33</b>	5	---
3"	<b>B38</b>	5	---



**Boss™ Washer Seal Male Spuds**

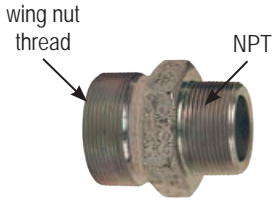

Thread	Plated Steel or Iron Part #
3/8"	<b>WMC</b> <sup>1</sup>
1/2"	<b>WM3</b> <sup>1</sup>
3/4"	<b>WM8</b> <sup>1</sup>
1"	<b>WM13</b> <sup>1</sup>
1 1/4"	<b>WM18</b> <sup>2</sup>
1 1/2"	<b>WM23</b> <sup>2</sup>
2"	<b>WM28</b> <sup>2</sup>
3"	<b>WM38</b> <sup>2</sup>

<sup>1</sup> plated steel  
<sup>2</sup> plated iron

**Boss™ Washer Seal Double Spuds**

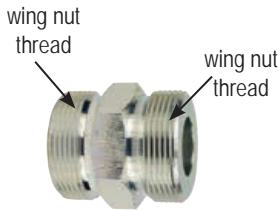

Thread	Plated Steel or Iron Part #
3/8"	---
1/2"	<b>DB3</b> <sup>1</sup>
3/4"	<b>DB13</b> <sup>1</sup>
1"	<b>DB13</b> <sup>1</sup>
1 1/4"	<b>DB23</b> <sup>2</sup>
1 1/2"	<b>DB23</b> <sup>2</sup>
2"	<b>DB28</b> <sup>2</sup>
3"	<b>DB38</b> <sup>2</sup>

<sup>1</sup> plated steel  
<sup>2</sup> plated iron

**Boss™ Washer Seal Washers**



Size	Nitrile Rubber Bonded, Non-Asbestos Klingersil® C-4401 Part #
3/8"	<b>WBC</b>
1/2"	<b>W2</b>
3/4"	<b>W12</b>
1"	<b>W12</b>
1 1/4"	<b>W17</b>
1 1/2"	<b>W17</b>
2"	<b>W27</b>
2 1/2"	<b>W32</b>
3"	<b>W37</b>

Boss™ Male Stems

Features:

- recommended for steam service up to **450°F (232°C)**
- use with Boss™ clamps on pages 75 - 76 for safety tags and safety tape see page 910

Hose x NPT size	Plated Steel Bar Stock Part #	Opt Qty	Size	Plated Iron Part #	Opt Qty
1/4" x 1/8"	<b>MS4X2</b>	100	---	---	---
1/4" x 1/4"	<b>MSA</b>	100	---	---	---
1/4" x 3/8"	<b>MSB</b>	25	---	---	---
3/8" x 1/4"	<b>MS6X4</b>	100	1 1/4"	<b>MS16</b>	20
3/8" x 3/8"	<b>MSC</b>	100	1 1/2"	<b>MS21</b>	20
3/8" x 1/2"	<b>MS6X8</b>	50	2"	<b>MS26</b>	10
1/2" x 1/4"	<b>MS8X4</b>	50	2 1/2"	<b>MS31</b>	5
1/2" x 3/8"	<b>MS8X6</b>	50	3"	<b>MS36</b>	5
1/2" x 1/2"	<b>MS1</b>	50	4"	<b>MS46</b>	2
1/2" x 3/4"	<b>MS8X12</b>	25	---	---	---
3/4" x 1/2"	<b>MS12X8</b>	25	---	---	---
3/4" x 3/4"	<b>MS6</b>	50	---	---	---
3/4" x 1"	<b>MS12X16</b>	25	---	---	---
1" x 3/4"	<b>MS16X12</b>	25	---	---	---
1" x 1"	<b>MS11</b>	25	---	---	---



plated steel



plated iron



316 stainless



brass

Size	316 Stainless Part #	Size	Brass Part #
1/2"	<b>RMS1</b>	---	---
3/4"	<b>RMS6</b>	3/4"	<b>BMS6</b>
1"	<b>RMS11</b>	1"	<b>BMS11</b>
1 1/4"	<b>RMS16</b>	1 1/4"	<b>BMS16</b>
1 1/2"	<b>RMS21</b>	1 1/2"	<b>BMS21</b>
2"	<b>RMS26</b>	2"	<b>BMS26</b>
2 1/2"	<b>RMS31</b>	---	---
3"	---	3"	---

LP Boss™ Male Stems - Male NPT End



Size	Schedule 40 Plated Steel Part #	Schedule 40 Stainless Steel Part #	Schedule 80 Plated Steel Part #
1¼"	<b>LP16</b>	---	<b>LP16-80</b> <sup>1</sup>
1½"	<b>LP21</b>	---	<b>LP21-80</b> <sup>1</sup>
2"	<b>LP26</b>	---	<b>LP26-80</b> <sup>1</sup>
2½"	<b>LP31</b>	---	---
3"	<b>LP36</b>	<b>RLP36</b>	---
4"	<b>LP46</b>	<b>RLP46</b>	---
6"	<b>LP66</b>	---	---

<sup>1</sup> schedule 80 stems meet NFPA 58

LP Boss™ Male Stems - Beveled End



Size	Schedule 40 Unplated Steel Part #
2"	<b>LPB26</b>
3"	<b>LPB36</b>

Boss™ Hose Menders

Features:

- collars designed to engage gripping fingers of Boss™ clamps
- ¾" - 3" plated iron; ½" plated steel



Size	Part #
½"	<b>M1</b>
¾"	<b>M6</b>
1"	<b>M11</b>
1¼"	<b>M16</b>
1½"	<b>M21</b>
2"	<b>M26</b>
2½"	<b>M31</b>
3"	<b>M36</b>

Boss™ Spud x Hose Shank

Material:

- seat: polymer



Thread	Steel Part #
1"	<b>GH1311</b>
2"	<b>GH2826</b>

## Boss™ Clamps

**⚠ WARNING**

- The bolts used in the Boss™ interlocking clamps are not standard bolts. They vary from standard bolts in their length, diameter, overall thread length and material hardness. These bolts can be retorqued, but it is **not** recommended that the bolts or clamps be reused, as they are designed for a single bend only. Dixon® recommends using only factory supplied replacement bolts.
- Torque values for clamps are based on dry bolts. The use of lubricant on bolts will adversely effect clamp performance. *Do not lubricate nuts and bolts.*
- For all Bolt Tightening Sequences, please visit [dixonvalve.com](http://dixonvalve.com)

**Features:**

- recommended for steam service up to **450°F (232°C)**
- recommended torque rating in ft. lbs.
- replacement nuts and bolts are available, contact Dixon® for more information

**2 Bolt Type, 2 Gripping Fingers**

Hose ID	Hose OD		Zinc Plated Iron Part #	Pkg Qty	Stainless Steel <sup>4</sup> Part #	Torque ft. lbs. <sup>2</sup>	Brass Part #	Torque
	from	to						
1/4"	36/64"	42/64"	<b>BD</b> <sup>3</sup>	100	---	6	---	---
3/8"	44/64"	56/64"	<b>CD</b> <sup>3</sup>	100	---	6	---	---
1/2"	52/64"	60/64"	<b>DD</b> <sup>3</sup>	100	---	6	---	---
1/2"	60/64"	1-4/64"	<b>B4</b> <sup>3</sup>	25	<b>RB4</b>	12	<b>BB4</b>	10
1/2"	1-4/64"	1-12/64"	<b>B5</b>	25	---	12	---	---
3/4"	1-10/64"	1-20/64"	<b>BU9</b> <sup>3</sup>	50	<b>RBU9</b>	21	<b>BBU9</b>	18
3/4"	1-20/64"	1-32/64"	<b>B9</b>	25	<b>RB9</b>	21	---	---
3/4"	1-32/64"	1-44/64"	<b>B10</b> <sup>3</sup>	25	---	21	---	---

**4 Bolt Type, 2 Gripping Fingers**

Hose ID	Hose OD		Zinc Plated Iron Part #	Pkg Qty	Stainless Steel <sup>4</sup> Part #	Torque <sup>2</sup> ft. lbs.	Brass Part #	Torque
	from	to						
1"	1-34/64"	1-46/64"	<b>BU14</b>	25	<b>RBU14</b>	21	<b>BBU14</b>	18
1"	1-44/64"	1-60/64"	<b>B14</b>	25	<b>RB14</b>	21	---	---
1"	1-60/64"	2-8/64"	<b>B15</b>	20	---	21	---	---
1 1/4"	1-32/64"	1-50/64"	<b>BU18</b>	20	---	40	---	---
1 1/4"	1-50/64"	2-6/64"	<b>BU19</b>	10	---	40	---	---
1 1/4"	2-8/64"	2-24/64"	<b>B19</b>	10	<b>RB19</b>	40	---	---
1 1/2"	1-52/64"	2"	<b>BU22</b>	10	---	40	---	---
1 1/2"	2"	2-14/64"	<b>B22</b>	10	---	40	---	---
1 1/2"	2-12/64"	2-24/64"	<b>BU24</b>	10	<b>RBU24</b>	40	---	---
1 1/2"	2-24/64"	2-36/64"	<b>B24</b>	10	<b>RB24</b>	40	---	---
1 1/2"	2-36/64"	2-48/64"	<b>B25</b>	10	---	40	---	---
2"	2-22/64"	2-34/64"	<b>BU28</b>	9	---	60	---	---
2"	2-32/64"	2-50/64"	<b>BU29</b>	10	<b>RBU29</b>	60	<b>BBU29</b> <sup>1</sup>	40
2"	2-48/64"	3-4/64"	<b>B29</b>	10	<b>RB29</b>	60	---	---
2"	3-6/64"	3-28/64"	<b>B30</b>	5	---	60	---	---
2 1/2"	3-6/64"	3-28/64"	<b>BU34</b>	5	---	60	---	---
2 1/2"	3-32/64"	3-60/64"	<b>B34</b>	5	---	150	---	---
3"	3-32/64"	3-60/64"	<b>BU35</b>	5	<b>RBU35</b>	150	---	---
3"	3-52/64"	4-4/64"	<b>B35</b>	5	---	150	---	---
3"	4-4/64"	4-28/64"	<b>B39</b>	5	---	200	---	---

<sup>1</sup> will become obsolete as inventory is depleted<sup>2</sup> torque applies to plated iron and stainless steel clamps<sup>3</sup> global investment cast carbon steel<sup>4</sup> When installing stainless steel bolts and nuts, the use of anti-seize or anti-galling lubricant is advised. A light coat is required on the bolt threads to prevent thread galling and artificial torque reading.

## Boss™ Clamps

**⚠ WARNING**

- The bolts used in the Boss™ interlocking clamps are not standard bolts. They vary from standard bolts in their length, diameter, overall thread length and material hardness. These bolts can be retorqued, but it is **not** recommended that the bolts or clamps be reused, as they are designed for a single bend only. Dixon® recommends using only factory supplied replacement bolts.
- Torque values for clamps are based on dry bolts. The use of lubricant on bolts will adversely effect clamp performance. *Do not lubricate nuts and bolts.*
- for all bolt tightening sequences, please visit [dixonvalve.com](http://dixonvalve.com)

**Features:**

- recommended for steam service up to **450°F (232°C)**
- recommended torque rating in ft. lbs.
- replacement nuts and bolts are available, contact Dixon® for more information

**4 Bolt Type, 4 Gripping Fingers**

Hose ID	Hose OD		Zinc Plated Iron Part #	Optional Qty	Torque Ft. Lbs.
	from	to			
½"	58/64"	1-2/64"	<b>968</b>	50	6
1"	1-26/64"	1-36/64"	<b>156</b>	20	21
1¼"	1-44/64"	1-56/64"	<b>187</b>	10	21
1¼"	1-56/64"	2-4/64"	<b>206</b>	20	21
1½"	2"	2-8/64"	<b>212</b>	10	21
1½"	2-4/64"	2-16/64"	<b>225</b>	10	40
2"	2-16/64"	2-32/64"	<b>250</b> <sup>1</sup>	10	40
2"	2-32/64"	2-48/64"	<b>275</b> <sup>1</sup>	10	40
2"	2-48/64"	3-4/64"	<b>306</b> <sup>1</sup>	5	60
2½"	3-4/64"	3-32/64"	<b>350</b>	5	60
3"	3-32/64"	3-48/64"	<b>375</b>	5	60
3"	3-48/64"	4"	<b>401</b>	5	150
3"	4"	4-12/64"	<b>418</b>	2	200
3"	4-12/64"	4-32/64"	<b>450</b>	2	200

<sup>1</sup> not to be used with GF81, GB26, WF81, B26, RGF81, RGB26, BGF81, RWF81, RB26

**6 Bolt Type, 3 Gripping Fingers**

Hose ID	Hose OD		Zinc Plated Iron Part #	Optional Qty	Torque Ft. Lbs.
	from	to			
3"	4-16/64"	4-52/64"	<b>BS39</b>	2	150
4"	4-40/64"	5"	<b>B45</b>	3	150
4"	4-56/64"	5-16/64"	<b>BS49</b>	2	200
4"	5-16/64"	5-38/64"	<b>BU49</b>	2	200
4"	5-34/64"	5-60/64"	<b>B49</b>	2	200

**6 Bolt Type, 6 Gripping Fingers**

Hose ID	Hose OD		Zinc Plated Iron Part #	Optional Qty	Torque Ft. Lbs.
	from	to			
6"	6-56/64"	7-24/64"	<b>750</b>	1	200
6"	7-32/64"	8"	<b>850</b>	1	200



**Ground Joint Air Hammer Couplings with Female Spud****Female Spud****Features:**

- rounded steel head of stem fits concave inserts in spuds for superior sealing
- metal-to-metal copper seat seal
- for use with Boss™ clamps on page 75 -76

Style	NPT Size	Plated Steel / Iron Part #
Compact	1/2"	<b>GDF6</b>
	3/4"	<b>GDF8</b>
Heavy Duty	3/4"	<b>GDF10</b>
	1"	<b>GDF12</b>

Hose Coupling  
Systems**Stems**

Style	Hose ID	Plated Steel Part #
Compact	1/2"	<b>GBA45</b>
	3/4"	<b>GBA46</b>
Heavy Duty	3/4"	<b>GBB18</b>
	1"	<b>GBB11</b>



B

**Wing Nuts**

Style	Hose ID and NPT Sizes	Coarse Nut Thread	Iron Part #
Compact	1/2"	1-31/64" OD x 8 TPI	<b>J47</b>
	3/4"		<b>J47</b>
Heavy Duty	3/4"	1-47/64" OD x 8 TPI	<b>DLB12</b>
	1"		<b>DLB12</b>

**Female Spuds**

Style	NPT Size	Coarse Nut Thread	Plated Steel w/ Copper seat Part #
Compact	1/2"	1-31/64" OD x 8 TPI	<b>GJ65</b>
	3/4"		<b>GJ55</b>
Heavy Duty	3/4"	1-47/64" OD x 8 TPI	<b>GDL8</b>
	1"		<b>GDL13</b>

**Male Spuds**

Style	Hose ID and NPT Sizes	Coarse Nut Thread	Plated Steel w/ Copper seat Part #
Compact	1/2"	1-31/64" OD x 8 TPI	<b>GJ60</b>
	3/4"		<b>GJ50</b>
Heavy Duty	3/4"	1-47/64" OD x 8 TPI	<b>GDL7</b>
	1"		<b>GDL10</b>

**Double Spuds**

Style	Hose ID and NPT Sizes	Coarse Nut Thread	Plated Steel w/ Copper seat Part #
Compact	1/2"	1-31/64" OD x 8 TPI	<b>GJ75</b>
	3/4"		<b>GJ75</b>
Heavy Duty	3/4"	1-47/64" OD x 8 TPI	<b>GDL25</b>
	1"		<b>GDL25</b>



## Dixon® Frac Fittings

### Application:

- used in the fast paced transfer of water, chemicals and sand slurry to a hydraulic fracturing site

### Features:

- one-piece stem design eliminates the leak path common with two-piece threaded systems
- interchangeable with current fittings; phase them into your operation
- designed to work with Dixon® King Crimp™ sleeves or ferrules. 
- 400 PSI** working pressure at **70°F (21°C)** for 3" and 4" sizes; 4:1 safety factor (SF) <sup>1</sup>
- 230 PSI** working pressure at **70°F (21°C)** for 6" size; 4:1 safety factor (SF)
- 150 PSI** working pressure at **70°F (21°C)** for 8" size; 3:1 safety factor (SF)

<sup>1</sup> 400 PSI working pressure with a minimum 4:1 safety factor (*hose burst: hose working pressure*) is only achieved with:

- 3" size uses standard crimp ferrules
- 4" size requires heavy duty (HD) crimp ferrules, CF400-6CSDH through CF400-16CSDH and heavy duty stems

Note: Water and petroleum transfer hoses rated from 100 to 300 PSI WP (4:1 SF) have excellent test results with the standard King Crimp™ ferrules CF400-xxCS.

### Materials:

- fittings: machined iron to ASTM standards; all stems zinc plated
- male 3", 4" and 6" NPT fittings are schedule 80 pipe; 8" NPT fittings are schedule 40 pipe; all sizes meet ASTM standards
- nut: forged steel meeting AISI standards

### Complete Male / Female Assembly



Size	Figure	Part #
2"	206	<b>NEW</b> HUMF206200CS
3"	100	HUMF100300CS
	206	HUMF206300CS
4"	100	HUMF100400CS
	206	HUMF206400CS
6"	100	HUMF100600CS
	206	HUMF206600CS
8"	100	HUMF100800CS
	206	HUMF206800CS

### Female



3" and 4"



8"

Size	Figure	Part #
2"	206	<b>NEW</b> HUF206200CS
3"	100	HUF100300CS
	206	HUF206300CS
4"	100	HUF100400CS
	206	HUF206400CS
6"	100	HUFALL600CS <sup>1</sup>
	206	
8"	100	HUFALL800CS <sup>1</sup>
	206	

<sup>1</sup> meets both figure 100 and 206 dimensional specifications



**Dixon® Frac Fittings**

Male with Nut

Size	Figure	Part #
2"	206	<i>HUM206200CS</i> <sup>1</sup> <b>NEW</b>
3"	100	<i>HUM100300CS</i>
	206	<i>HUM206300CS</i> <sup>1</sup>
4"	100	<i>HUM100400CS</i>
	206	<i>HUM206400CS</i> <sup>1</sup>
6"	100	<i>HUM100600CS</i>
	206	<i>HUM206600CS</i> <sup>1</sup>
8"	100	<i>HUM100800CS</i>
	206	<i>HUM206800CS</i> <sup>1</sup>

<sup>1</sup> includes nut and O-ring

3" and 4"



6" and 8"

Hose Coupling  
Systems**Suction Service Fittings**

Size	Figure	Description	Forged Steel Part #
5"	50	socket weld x suction male hammer union (includes O-ring, no nut)	<i>HUSM500SW-1</i>
		socket weld x suction female hammer union	<i>HUSF500SW</i>
5"	N/A	split nut, suction and discharge, black	<i>HUS500RN</i>



HUSM500SW-1



HUSF500SW

**NEW****Dixon® Frac Fitting O-rings**

Size	Figure	Buna-N Part #
3"	206	<i>O238BU</i>
4"	206	<i>O347BU</i>
6"	206	<i>O440BU</i>
8"	206	<i>O447BU</i>

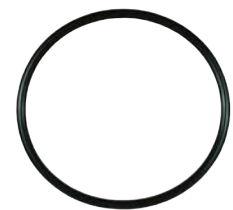
**King Crimp™ Style Short Frac Ferrules**

Hose ID	Hose OD		Ferrule Wall Thickness	Ferrule ID	Ferrule Overall Length	Carbon Steel Part #
	From	To				
8"	8-29/64"	8-36/64"	.120"	8.625"	4.25"	<i>CFS800-1CS</i>
	8-37/64"	8-44/64"	.120"	8.750"	4.25"	<i>CFS800-2CS</i>
	8-45/64"	8-52/64"	.120"	8.875"	4.25"	<i>CFS800-3CS</i>
	8-53/64"	8-60/64"	.120"	9.000"	4.25"	<i>CFS800-4CS</i>
	8-61/64"	9-4/64"	.120"	9.125"	4.25"	<i>CFS800-5CS</i>
	9-5/64"	9-12/64"	.120"	9.250"	4.25"	<i>CFS800-6CS</i>
	9-13/64"	9-20/64"	.120"	9.375"	4.25"	<i>CFS800-7CS</i>
	9-21/64"	9-28/64"	.120"	9.500"	4.25"	<i>CFS800-8CS</i>



Dixon® Hammer Union Nuts

One-Piece

Features:

- long lasting and dependable nut
- all nuts are interchangeable with reliable brands
- cold working pressure: **2,000 PSI**
- 6" and 8" sizes have 4 lug design for more surface area to hammer



3" and 4"



6" and 8"

Size	Figure	Forged Steel AISI Standards Part #
2"	206	<b>NEW</b> HU206200N
3"	100	HU100300N
	206	HU206300N
4"	100	HU100400N
	206	HU206400N
6"	100	HU100600N
	206	HU206600N
8"	100	HU100800N
	206	HU206800N

Two-Piece

Applications:

- replacement for damaged hammer union nuts
- used with male one-piece flange adapters

Features:

- lug design provides enlarged surface area to hammer
- repair nut is pinned and bolted for perfect alignment
- nut can be installed on pre-existing hammer union assembly
- cold working pressure: **2,000 PSI**
- 4" Figure 200/206 nut is interchangeable with reliable brands
- 6" and 8" Figure 100/200/206 nuts are interchangeable with reliable brands
- available in other series and sizes, contact Dixon®



figure 200 / 206



figure 100

Dixon® recommends using Loctite® Threadlocker Red 271™ when bolting together two-piece hammer union nuts to ensure that bolts do not loosen when in service. Option two is to weld the seams of the split nut. Bolt torque recommendation is 60 foot pounds. 

Size	Figure	Forged Steel AISI Standards Part #
4"	split nut, figure 200/206, blue (includes bolts)	HU200400RN
5"	split nut, suction and discharge, black	HUS500RN
6"	split nut, figure 100, black (includes bolts)	HU100600RN
	split nut, figure 200/206, blue (includes bolts)	HU200600RN
8"	split nut, figure 100, black (includes bolts)	HU100800RN
	split nut, figure 200/206, blue (includes bolts)	HU200800RN

## Hammer Union Caps and Plugs

### Application:

- Prevents leakage of hydraulic fracturing fluids from hammer union connections used on manifolds and hose assemblies. Hammer union caps and plugs can be used in pressurized service or as dust caps/plugs on site or when transferring equipment.

### Features:

- forged steel construction ensures longevity, reliability and performance
- caps are designed with larger lugs for easier installation and disassembling and include a threaded bolt hole for attaching chain or cable
- plugs are designed with larger handle for easier installation and disassembling and include a handle hole to attach chain or cable
- forged steel meets AISI standards

### Blanking Caps

Size	Figure	Description	Forged Steel Part #
2"	206	includes nut/plug body, O-ring and retaining ring	<b>NEW</b> <i>HUC206200</i>
4"	206	includes nut/plug body, O-ring and retaining ring blue with nut/plug body and retaining ring with bolt & chain	<b>NEW</b> <i>HUC206400</i> <i>HUC206400BC</i>
	207	cap only blanking cap with bolt & chain	<i>HUC207400</i> <i>HUC207400BC</i>
6"	206	includes nut/plug body, o-ring and retaining ring	<b>NEW</b> <i>HUC206600</i>
8"	206	includes nut/plug body, o-ring and retaining ring	<i>HUC206800</i>



HUC207400

### Blanking Plugs

Size	Figure	Description	Forged Steel Part #
4"	207	plug only with chain and d-link (shackle/bolt)	<i>HUP207400</i> <i>HUP207400DC</i>
6"	100/200/206	hammer union, connects to figures 100/200/206	<b>NEW</b> <i>HUPALL600</i>
8"	100/200/206	hammer union, connects to figures 100/200/206	<i>HUPALL800</i>



HUP207400



HUPALL600

### O-ring

Size	Buna-N Part #
4"	<b>0429BU</b>

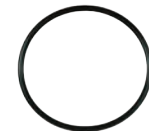

## Dixon® One-Piece Flange Adapters

### Application:

- used in the transfer of water, brine, water-based chemicals, water-based acids, and gelatinous proppant (sand) slurry used at hydraulic fracturing sites
- use with **HU200400RN** two-piece nut

### Features:

- flange x female or male hammer union straights (standard or short length)
- 45° elbows in female and male (flange x hammer union)
- no welds or pipe threads to deteriorate and cause premature leakage
- two-piece nut is pinned and bolted for perfect alignment
- all 4" Figure 206 threads are interchangeable with other reliable brands
- 125# flange match the bolt pattern of 150# flange
- iron adapters meet ASTM standards
- forged steel nuts meet AISI standards

### Flange Adapters - Straight



HUF206400FLG

**NEW**  
**NEW**

Size	Figure	Description	Overall Length	Iron Part #
4"	206	female hammer union x 125# flange	5-1/8"	<b>HUF206400FLG</b>
		male hammer union x 125# flange includes nut and Buna-N O-ring	5-9/16" (with nut)	<b>HUM206400FLG</b>
6"	100/200/206	125# flange x female hammer union; connects to figures 100/200/206	4-1/2"	<b>HUFALL600FLG</b>
	206	125# flange x male (includes iron nut and O-ring)	4-15/16"	<b>HUM206600FLG<sup>1</sup></b>
8"	100/200/206	125# flange x female hammer union; connects to figures 100/200/206	4-1/2"	<b>HUFALL800FLG</b>
	206	125# flange x male (includes nut and O-ring)	5-7/32"	<b>HUM206800FLG<sup>1</sup></b>

<sup>1</sup> nut is iron

### Flange Adapters - Short

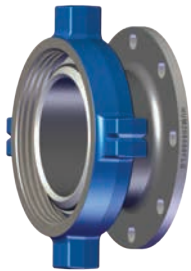

HUM206400FLG-ST

Size	Figure	Description	Overall Length	Iron Part #
4"	206	female hammer union x 125# flange short	3"	<b>HUF206400FLG-ST</b>
		male hammer union x 125# flange short includes nut and Buna-N O-ring	3-13/32"	<b>HUM206400FLG-ST</b>

### Flange Adapters - 45° Elbow



HUM206400FLG-45

Size	Figure	Description	Overall Length	Iron Part #
4"	206	female hammer union x 125# flange 45° elbow	10-31/32"	<b>HUF206400FLG-45</b>
		male hammer union x 125# flange 45° elbow includes nut and Buna-N O-ring	12-1/32" (with nut)	<b>HUM206400FLG-45</b>

### O-ring

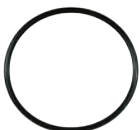

Size	Buna-N Part #
4"	<b>O347BU</b>

- For flange dimensions, diagrams and additional information please reference [dixonvalve.com](http://dixonvalve.com).

## Dixon® One-Piece Adapters

### 150# Flange to Weld Adapters

**Features:**

- used on a 12" pipe manifold
- easy to weld
- formed butt weld provides accurate alignment
- compatible with other reliable brands

Size	Description	Weldable Cast Steel Part #
4"	150# flange x weld adapter, vertical	<b>WA4FL 12X750-1</b>
	150# flange x weld adapter, offset	<b>WA4FL 12X750-2</b>
	150# flange x weld adapter, vertical	<b>WA4FL 12X1050-1</b>
	150# flange x weld adapter, offset	<b>WA4FL 12X1050-2</b>

**Vertical Pattern**



**Offset Pattern**

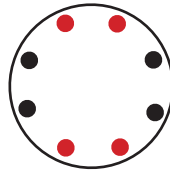

10 1/2"

Hose Coupling Systems

- For flange dimensions, diagrams and additional information please reference [dixonvalve.com](http://dixonvalve.com).

### 125# Flange x Male NPT

Size	Description	Ductile Iron Part #
4"	125# flange x male NPT	<b>4FAMT</b>
	125# flange x male NPT - long	<b>4FAMTL</b>



4FAMT

### Port Adapter

Size	Figure	Description	Iron Part #
2"	206	male NPT x female hammer union	<b>HUF206200MT</b>



### Hammer Union Elbows

**Features:**

- no welds or pipe threads to deteriorate and cause premature leakage
- easy to weld to 12" pipe manifolds

Size	Figure	Description	Ductile Iron Part #
4"	206	male hammer union x female hammer union 45° elbow	<b>HUMF20640045</b>
		male hammer union x female hammer union 60° elbow	<b>HUMF20640060</b>
		male hammer union x female hammer union 80° elbow	<b>HUMF20640080</b>
		male hammer union x female hammer union 90° elbow	<b>HUMF20640090</b>



HUMF20640080

### Boss™ Low Pressure System Components

Dixon® is committed to improving end user productivity and reducing environmental and safety related incidents on the low pressure side of hydraulic fracturing sites. Boss™ Low Pressure System products are built around the premise; "no welds, no threads, no leaks." The product line is continually expanding, visit [dixonvalve.com/bosslps](http://dixonvalve.com/bosslps) for the latest updates.

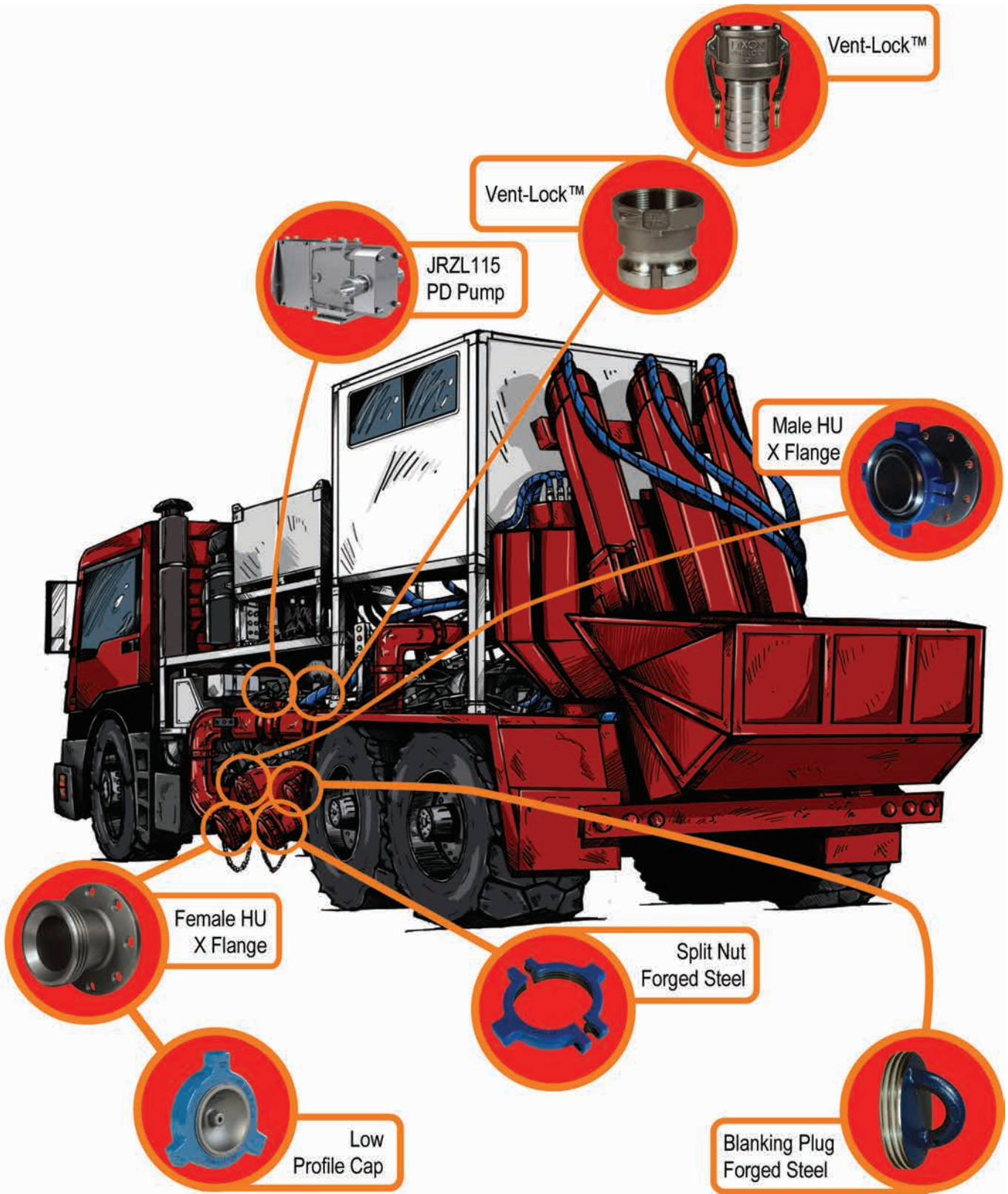

## Holedall™ Coupling Machines

Rams, are powerful finely engineered machines designed specifically to externally swage and internally expand Holedall™ couplings by hydraulic pressure securely attaching Holedall™ couplings to hose. Since each ram generates all the hydraulic pressure required to attach the Holedall™ coupling, one person can easily operate the equipment.

### 15 Ton Ram



#### Features:

- for internally expanded couplings only
- can expand 1" through 3" steel fittings and 5/8" through 4" brass Holedall™ Petroleum fittings
- produces up to 10,000 PSI, for up to 15 tons of ram force
- bench mounted model (optional stand available)
- motor: ½ h.p., 115 volt, 60 cycle, single phase with foot pedal

### 100 Ton Ram

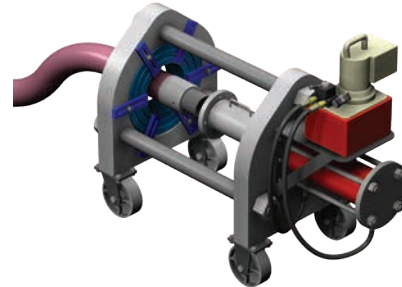

#### Features:

- for externally swaging Holedall™ fittings to hose, sizes 1¼" through 10" ID
- optional accessories allow the ram to be used for internally expanded couplings on hose from 1" through 6"
- capable of producing up to 100 tons of ram force
- motor: 1½ h.p., 115 volt, 60 cycle, single phase motor is standard with remote, (220/440 volt motors are available)

### 25 Ton Ram



#### Features:

- can externally swage ¼" through 4" ID hose and internally expand 5/8" through 4" ID hose with proper equipment
- produces up to 10,000 PSI of line pressure for up to 25 tons of ram force
- free standing model
- high speed pump kit option is available
- motor is ½ h.p., 115 volt 60 cycle, single phase with foot pedal

### 350 Ton Ram

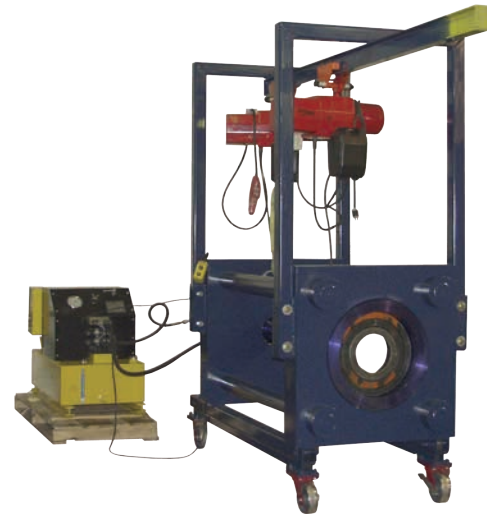

#### Features:

- for externally swaging Holedall™ and Rotary fittings
- produces up to 354 tons of ram force for swaging
- 14" 150 lb. flange will fit through the bed plate
- ram has 36" of stroke
- motor: 12½ h.p., 230 volt, 60Hz, 3 phase motor is standard with remote

### 50 Ton Ram



#### Features:

- can externally swage 1¼" through 6" ID hose and internally expand 1" through 6" ID hose with proper equipment
- produces up to 10,000 PSI, for up to 50 tons of ram force
- bench mounted model (optional stand available)
- motor is 1½ h.p., 115 volt, 60 cycle, single phase, standard with remote, (220/440 volt motors are available)

**!** All Rams require dies of the proper size to reduce the ferrule to the proper diameter for a good grip on the hose. Pushers of the proper size must be used on the end of the Ram to push the Holedall™ fitting through the die. Die and pusher selection depends on the sizes and types of hoses being coupled. Ferrule recommendations are available upon request. Consult Dixon® for specific details.

## Recommended Working Pressures

### ⚠ WARNING

Holedall™ couplings, regardless of coupling style, are never to be used for steam service at any pressure. Holedall™ fittings listed below are not to be used with cable reinforced high-pressure hose, 4 or 6 braid wire hydraulic hose or any other service not listed in recommendations. In addition, Internally Expanded

Holedall™ couplings are not to be used with plastic lined chemical hose. Consult Dixon® for recommendations on usage.

Holedall™ couplings (Externally Swaged), to perform satisfactorily, must be applied properly in accordance with Dixon® assembly procedures, using the correct die and ferrule for that particular hose end OD. The Dixon® Die and Ferrule Recommendation Guide is to be used to select correct dies and ferrules. If you do not have the updated Die and Ferrule Recommendation Guide, consult Dixon®. Strict adherence to ferrule OD range (Internally Expanded) for each hose end to be assembled is essential for satisfactory performance.

Note: Hose service working pressure (including surges and spikes) is never to exceed the maximum recommended working pressure for the fitting (reference chart below) <sup>2</sup>. Media being transported through the hose should be compatible with the stem material. Compatibility of ferrule material with the environment in which it will be used is recommended. Consult the Compatibility Chart on [dixonvalve.com](http://dixonvalve.com) or contact Dixon® for material compatibility. For applications other than the ones listed, please consult Dixon®.

Size	Externally Swaged				Internally Expanded			
	Standard Fittings <sup>1</sup>	Long Style Fittings <sup>1</sup>	Light Duty Fittings		Cam and Groove <sup>1</sup>	Holedall™ DIN Crimp Stems <sup>1</sup>	Internally Expanded <sup>1</sup>	Flow Chief / Crimp Sanitary Fittings <sup>1</sup>
			NO Notched Fittings <sup>1</sup>	NOS Notched Short Fittings <sup>1</sup>				
	TM, TP, TG, TMR, TPR, TGR	TML, TPL, TGL	TM, TP, TG, RN•••NO	RST•••NOS, STC•••NOS, GAS••••NOS		HA••••	IXM, IXV, IXH	IXSE, IXFS, IXMS, CSSR
3/4"	---	---	---	---	---	---	---	---
1"	---	---	---	---	250	---	---	---
1 1/4"	600	1,000	350	---	---	---	800	---
1 3/8"	---	---	---	---	---	---	---	---
1 1/2"	600	1,000	350	250	250	145	800	250
2"	600	1,000	350	250	250	145	800	250
2 1/2"	600	1,000	250	---	150	---	600	250
3"	600	1,000	250	250	125	145	600 <sup>3</sup>	250
4"	500	850	250	<sup>4</sup>	100	---	500 <sup>3</sup>	200
5"	450	750	---	---	---	---	---	---
6"	400	700	---	---	---	---	400	---
8"	350	600	---	---	---	---	---	---
10"	300	550	---	---	---	---	---	---

<sup>1</sup> maximum recommended working pressures, in PSI, given at 70°F ambient temperature

<sup>2</sup> The assembly's (hose + coupling) maximum working pressure is the lesser of:

- 1) The hose rated working pressure, or
- 2) The coupling rated working pressure

<sup>3</sup> For hoses which use IXF48-3 to IXF48-5 and IXF64-2 to IXF64-5, consult Dixon® for working pressures. See notes below for specific recommendations.

<sup>4</sup> Contact Dixon® for pressure recommendations

### Standard Fittings

Recommended for use on most one and two wire braid reinforced hoses, fiber reinforced (braided or spiraled) with or without helical wire such as: oil suction and discharge hose, barge and dock loading and unloading hose as well as LP gas hose, anhydrous ammonia hose, acid chemical hose and high pressure air and water hose.

### Long Style Fittings

Recommended for use on hose as listed under standard fittings where additional retention is required due to higher working pressures or end pull. Consult maximum working pressure chart or call Dixon®.

### Light Duty Fittings

Recommended for use in the same applications as standard fittings above where lower working pressures are encountered. Consult maximum working pressure chart or consult Dixon®.

### Internally Expanded Fittings

Recommended for concrete placement, grout and plaster, food, dairy, pharmaceutical as well as other applications where increased flow capacity is important. Consult maximum working pressure chart or call Dixon® for additional application and working pressure information.



## Holedall™ External Swage Coupling System

The Holedall™ coupling system provides outstanding strength, durability and safety.

The Holedall™ system is a method of attaching couplings to hose utilizing a progressive swage. The patented Holedall™ couplings include a Holedall™ stem and a specially engineered ferrule. The hydraulic swaging of the coupling to the hose is accomplished by pushing the ferrule through a die which reduces the ferrule OD, thus providing a 360° uninterrupted compression band around the hose.

A hydraulic ram is the only piece of machinery necessary to accomplish the coupling. Available in five different sizes - 15, 25, 50, 100 and 350 ton see page 85 - these rams will accommodate dies and pushers of various sizes so that hoses up to 10" in diameter may be coupled.

This multi-purpose, high pressure coupling system requires no bolts and results in a clean coupling with no protrusions. The swaging operation is fast and hose of various lengths and different styles can be coupled. Ease of operation, flexibility and economy make the Holedall™ method an unequalled assembly system.

### Features:

- provides long-lasting efficiency and safety
- lightweight coupling consisting of ferrule and stem
- streamlined, no protrusions to snag on equipment
- available in stainless steel and carbon steel
- available in multiple configurations: pipe thread, plain end, grooved or flanged ends

Holedall™ stems and ferrules are specifically designed to be used together as a coupling system. Due to differences in dimensions and tolerances, for safety reasons, do not use other manufacturer's stems or ferrules with Holedall™ products. 

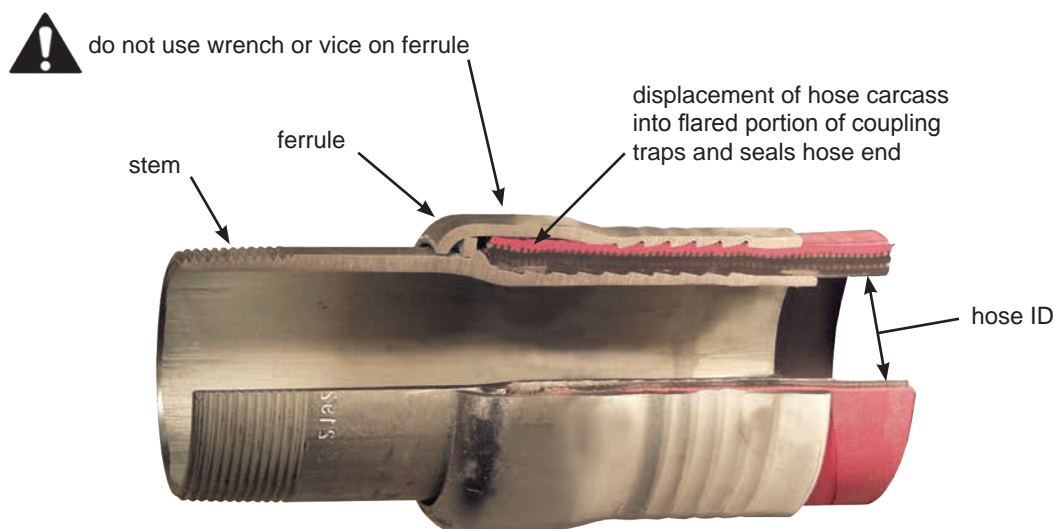

cross-section of Holedall™ externally swaged assembly

**External Swage Stems**

**Male NPT End Tubular Type**

**Features:**

- designed for hose ID's 1¼" - 10", ferrule size depends on the hose OD, refer to page 91 to select the correct ferrule
- for higher working pressure applications use long style stems and ferrules

Hose ID	<i>Plated Carbon Steel</i> Part #	<i>316 Stainless</i> Part #	<i>Long Style Carbon Steel</i> Part #
1¼"	<b>TM20</b>	<b>TMR20</b>	<b>TML20</b>
1½"	<b>TM24</b>	<b>TMR24</b>	<b>TML24</b>
2"	<b>TM32</b>	<b>TMR32</b>	<b>TML32</b>
2½"	<b>TM40</b>	<b>TMR40</b>	<b>TML40</b>
3"	<b>TM48</b>	<b>TMR48</b>	<b>TML48</b>
4"	<b>TM64</b>	<b>TMR64</b>	<b>TML64</b>
5"	<b>TM80</b>	---	<b>TML80</b>
6"	<b>TM96</b> <b>TMR96-42</b>	<b>TMR96</b> ---	<b>TML96</b> ---
8"	<b>TM128</b>	---	<b>TML128</b>
10"	<b>TM160</b>	---	---



**Beveled End for Welding**

Hose ID	<i>Unplated Carbon Steel</i> Part #	<i>316 Stainless Steel</i> Part #	<i>Long Style Unplated Carbon Steel</i> Part #
1¼"	<b>TP20</b>	---	<b>TPL20</b>
1½"	<b>TP24</b>	---	<b>TPL24</b>
2"	<b>TP32</b>	<b>TPR32</b>	<b>TPL32</b>
2½"	<b>TP40</b>	---	<b>TPL40</b>
3"	<b>TP48</b>	<b>TPR48</b>	<b>TPL48</b>
4"	<b>TP64</b>	<b>TPR64</b>	<b>TPL64</b>
5"	<b>TP80</b>	---	<b>TPL80</b>
6"	<b>TP96</b>	---	<b>TPL96</b>
8"	<b>TP128</b>	---	<b>TPL128</b>
10"	<b>TP160</b>	---	<b>TPL160</b>



**Grooved End**

Hose ID	<i>Plated Carbon Steel</i> Part #	<i>316 Stainless</i> Part #	<i>Long Style Plated Carbon Steel</i> Part #
1¼"	<b>TG20</b>	---	<b>TGL20</b>
1½"	<b>TG24</b>	<b>TGR24</b>	<b>TGL24</b>
2"	<b>TG32</b>	<b>TGR32</b>	<b>TGL32</b>
2½"	<b>TG40</b>	<b>TGR40</b>	<b>TGL40</b>
3"	<b>TG48</b>	<b>TGR48</b>	<b>TGL48</b>
4"	<b>TG64</b>	<b>TGR64</b>	<b>TGL64</b>
5"	<b>TG80</b>	---	<b>TGL80</b>
6"	<b>TG96</b>	---	<b>TGL96</b>
8"	<b>TG128</b>	---	<b>TGL128</b>
10"	<b>TG160</b>	---	<b>TGL160</b>

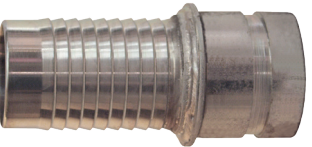

**Special Holedall™ Stems**

Hose ID	Material	Thread	Part #
4"	carbon steel	NPT	<b>TM64-42</b>
4"	carbon steel	NPT	<b>TML64-42</b>
6"	unplated carbon steel	NPT	<b>TM96-42</b>
6"	316 stainless	NPT	<b>TMR96-42</b>
6"	carbon steel	NPT	<b>TML96-42</b>
6"	unplated carbon steel	beveled	<b>TP96-42</b>
6"	316 stainless	beveled	<b>TPR96-42</b>
6"	carbon steel	grooved	<b>TGL96-42</b>
6"	carbon steel	grooved	<b>TG96-42</b>
8"	unplated carbon steel	NPT	<b>TM128-42</b>
8"	carbon steel	beveled	<b>TP128-42</b>
8"	carbon steel	grooved	<b>TG128-42</b>



Hose Coupling Systems

- use with external swage ferrules on page 91

**External Swage**

**Flange Assemblies**

**Features:**

- 150# ASA flange drilling available with carbon steel stem, flange and ferrule, or with 316 stainless steel stem and flange and carbon steel ferrule
- available in other sizes, consult Dixon®

**Fixed Flange**

Hose ID	Hose OD		Carbon Steel	Stainless Steel
	From	To	Part #	Part #
2"	2-28/64"	2-40/64"	<b>32P1SO15</b>	<b>R32P1SOR15</b>
	2-41/64"	2-48/64"	<b>32P2SO15</b>	<b>R32P2SOR15</b>
	2-49/64"	2-56/64"	<b>32P3SO15</b>	<b>R32P3SOR15</b>
3"	3-30/64"	3-40/64"	<b>48P1SO15</b>	<b>R48P1SOR15</b>
	3-41/64"	3-48/64"	<b>48P2SO15</b>	<b>R48P2SOR15</b>
	3-49/64"	3-56/64"	<b>48P3SO15</b>	<b>R48P3SOR15</b>
4"	4-40/64"	4-44/64"	<b>64P1SO15</b>	<b>R64P1SOR15</b>
	4-45/64"	4-52/64"	<b>64P2SO15</b>	<b>R64P2SOR15</b>
	4-53/64"	4-60/64"	<b>64P3SO15</b>	<b>R64P3SOR15</b>
6"	7"	7-4/64"	<b>96P1SO15</b>	<b>R96P1SOR15</b>
	7-5/64"	7-12/64"	<b>96P2SO15</b>	<b>R96P2SOR15</b>
	7-13/64"	7-20/64"	<b>96P3SO15</b>	<b>R96P3SOR15</b>
8"	9-20/64"	9-24/64"	<b>128P1SO15</b>	---
	9-25/64"	9-32/64"	<b>128P2SO15</b>	---
	9-33/64"	9-40/64"	<b>128P3SO15</b>	---



**Floating Flange**

Hose ID	Hose OD		Carbon Steel	Stainless Steel
	From	To	Part #	Part #
2"	2-28/64"	2-40/64"	<b>32P1LJ15</b>	<b>R32P1LJR15</b>
	2-41/64"	2-48/64"	<b>32P2LJ15</b>	<b>R32P2LJR15</b>
	2-49/64"	2-56/64"	<b>32P3LJ15</b>	<b>R32P3LJR15</b>
3"	3-30/64"	3-40/64"	<b>48P1LJ15</b>	<b>R48P1LJR15</b>
	3-41/64"	3-48/64"	<b>48P2LJ15</b>	<b>R48P2LJR15</b>
	3-49/64"	3-56/64"	<b>48P3LJ15</b>	<b>R48P3LJR15</b>
4"	4-40/64"	4-44/64"	<b>64P1LJ15</b>	<b>R64P1LJR15</b>
	4-45/64"	4-52/64"	<b>64P2LJ15</b>	<b>R64P2LJR15</b>
	4-53/64"	4-60/64"	<b>64P3LJ15</b>	<b>R64P3LJR15</b>
6"	7"	7-4/64"	<b>96P1LJ15</b>	<b>R96P1LJR15</b>
	7-5/64"	7-12/64"	<b>96P2LJ15</b>	<b>R96P2LJR15</b>
	7-13/64"	7-20/64"	<b>96P3LJ15</b>	<b>R96P3LJR15</b>
8"	9-20/64"	9-24/64"	<b>128P1LJ15</b>	---
	9-25/64"	9-32/64"	<b>128P2LJ15</b>	---
	9-33/64"	9-40/64"	<b>128P3LJ15</b>	---



- For flange dimensions, diagrams and additional information please reference [dixonvalve.com](http://dixonvalve.com).

**External Swage Stems - Female End**

Hose Coupling Systems



two piece design  
1"



one piece design  
1 1/4" - 2"

Size	Hose OD		Plated Carbon Steel Part #
	from	to	
1"	1-30/64"	1-34/64"	<b>TF16WF1-80</b>
	1-34/64"	1-38/64"	<b>TF16WF2-80</b>
	1-35/64"	1-42/64"	<b>TF16WF3-80</b>
1 1/4"	1-44/64"	1-48/64"	<b>TF20WF1-80<sup>1</sup></b>
	1-49/64"	1-56/64"	<b>TF20WF2-80<sup>1</sup></b>
	1-57/64"	2"	<b>TF20WF3-80<sup>1</sup></b>
2"	2-36/64"	2-40/64"	<b>TF32WF1-80<sup>1</sup></b>
	2-41/64"	2-48/64"	<b>TF32WF2-80<sup>1</sup></b>
	2-49/64"	2-56/64"	<b>TF32WF3-80<sup>1</sup></b>

<sup>1</sup> Special pusher required for 1 1/4" and 2" sizes: 1 1/4" **25PUSH125-MOD**, 2" **25PUSH200MOD**

**External Swage Uni-Range Male Couplings**

**Applications:**

- Recommended for use on most one or two wire braid reinforced hoses, fiber reinforced (braided or spiral) with or without helical wire such as chemical, high pressure air and water hoses, and LP gas hoses.

**Features:**

- designed for smaller hose systems, hose ID's of 1/4" - 1"
- shipped complete with factory assembled stem and ferrule combination
- can be swaged or crimped
- stainless steel stems are investment cast
- other hose OD's available, consult Dixon®



Hose ID	Hose ID		Plated Carbon Steel Part #	Stainless / Carbon Steel Part #	Stainless Steel Part #
	From	To			
1/4"	34/64"	38/64"	<b>4P1</b>	---	---
	38/64"	42/64"	<b>4P2</b>	---	---
	42/64"	46/64"	<b>4P3</b>	---	---
3/8"	46/64"	50/64"	<b>6P1</b>	---	---
	50/64"	54/64"	<b>6P2</b>	---	---
	54/64"	58/64"	<b>6P3</b>	---	---
1/2"	54/64"	58/64"	<b>8P1</b>	---	---
	58/64"	62/64"	<b>8P2</b>	---	<b>R8P2SS</b>
	62/64"	1-2/64"	<b>8P3</b>	---	---
3/4"	1-6/64"	1-12/64"	---	---	<b>R12P1250</b>
	1-10/64"	1-14/64"	<b>12P1</b>	<b>R12P1</b>	---
	1-13/64"	1-22/64"	---	---	<b>R12P1370</b>
	1-14/64"	1-18/64"	<b>12P2</b>	<b>R12P2</b>	---
	1-18/64"	1-22/64"	<b>12P3</b>	<b>R12P3</b>	---
1"	1-30/64"	1-34/64"	<b>16P1</b>	<b>R16P1</b>	---
	1-30/64"	1-38/64"	---	---	<b>R16P1620</b>
	1-34/64"	1-38/64"	<b>16P2</b>	<b>R16P2</b>	---
	1-38/64"	1-42/64"	<b>16P3</b>	<b>R16P3</b>	---
	1-38/64"	1-46/64"	---	---	<b>R16P1770</b>
	1-42/64"	1-46/64"	<b>16P4</b>	<b>R16P4</b>	---

### External Swage Ferrules

The selection of ferrules is very important to achieve the proper coupling-to-hose assembly. For assistance in proper selection contact Dixon®.

**Features:**

- plated carbon steel
- style F ferrules are used with all standard length stems, page 88
- style FL ferrules are extra long and are used with all long style stems, page 88

Size	Hose OD		Plated Carbon Steel	Plated Carbon Steel
	From	To	Part #	Long Style Part #
1¼"	1-44/64"	1-48/64"	<b>F20-1</b>	<b>FL20-1</b>
	1-49/64"	1-56/64"	<b>F20-2</b>	<b>FL20-2</b>
	1-57/64"	2"	<b>F20-3</b>	<b>FL20-3</b>
	2-1/64"	2-8/64"	<b>F20-4</b>	<b>FL20-4</b>
1½"	1-58/64"	2"	<b>F24-1</b>	<b>FL24-1</b>
	2-1/64"	2-8/64"	<b>F24-2</b>	<b>FL24-2</b>
	2-9/64"	2-16/64"	<b>F24-3</b>	<b>FL24-3</b>
	2-17/64"	2-24/64"	<b>F24-4</b>	<b>FL24-4</b>
	2-25/64"	2-32/64"	<b>F24-5</b>	<b>FL24-5</b>
2"	2-28/64"	2-40/64"	<b>F32-1</b>	<b>FL32-1</b>
	2-41/64"	2-48/64"	<b>F32-2</b>	<b>FL32-2</b>
	2-49/64"	2-56/64"	<b>F32-3</b>	<b>FL32-3</b>
	2-57/64"	3-2/64"	<b>F32-4</b>	<b>FL32-4</b>
2½"	2-62/64"	3-8/64"	<b>F40-1</b>	<b>FL40-1</b>
	3-9/64"	3-16/64"	<b>F40-2</b>	<b>FL40-2</b>
	3-17/64"	3-24/64"	<b>F40-3</b>	<b>FL40-3</b>
	3-25/64"	3-32/64"	<b>F40-4</b>	<b>FL40-4</b>
	3-33/64"	3-40/64"	<b>F40-5</b>	<b>FL40-5</b>
3"	3-30/64"	3-40/64"	<b>F48-1</b>	<b>FL48-1</b>
	3-41/64"	3-48/64"	<b>F48-2</b>	<b>FL48-2</b>
	3-49/64"	3-56/64"	<b>F48-3</b>	<b>FL48-3</b>
	3-57/64"	4"	<b>F48-4</b>	<b>FL48-4</b>
	4-1/64"	4-8/64"	<b>F48-5</b>	<b>FL48-5</b>
4"	4-30/64"	4-39/64"	<b>F64-Z</b> <sup>1</sup>	<b>FL64-Z</b> <sup>1</sup>
	4-40/64"	4-44/64"	<b>F64-1</b>	<b>FL64-1</b>
	4-45/64"	4-52/64"	<b>F64-2</b>	<b>FL64-2</b>
	4-53/64"	4-60/64"	<b>F64-3</b>	<b>FL64-3</b>
	4-61/64"	5-4/64"	<b>F64-4</b>	<b>FL64-4</b>
	5-5/64"	5-12/64"	<b>F64-5</b>	<b>FL64-5</b>
	5-13/64"	5-20/64"	<b>F64-6</b>	<b>FL64-6</b>
	5-21/64"	5-28/64"	<b>F64-7</b>	<b>FL64-7</b>
5-29/64"	5-36/64"	<b>F64-8</b>	<b>FL64-8</b>	
5"	5-56/64"	5-60/64"	<b>F80-1</b>	<b>FL80-1</b>
	5-61/64"	6-4/64"	<b>F80-2</b>	<b>FL80-2</b>
	6-5/64"	6-12/64"	<b>F80-3</b>	<b>FL80-3</b>
	6-13/64"	6-20/64"	<b>F80-4</b>	<b>FL80-4</b>
	6-21/64"	6-28/64"	<b>F80-5</b>	<b>FL80-5</b>
	6-29/64"	6-38/64"	<b>F80-6</b>	<b>FL80-6</b>
	6-37/64"	6-44/64"	<b>F80-7</b>	<b>FL80-7</b>
6"	6-44/64"	6-63/64"	<b>F96-Z</b> <sup>1</sup>	<b>FL96-Z</b> <sup>1</sup>
	7"	7-4/64"	<b>F96-1</b>	<b>FL96-1</b>
	7-5/64"	7-12/64"	<b>F96-2</b>	<b>FL96-2</b>
	7-13/64"	7-20/64"	<b>F96-3</b>	<b>FL96-3</b>
	7-21/64"	7-28/64"	<b>F96-4</b>	<b>FL96-4</b>
	7-29/64"	7-36/64"	<b>F96-5</b>	<b>FL96-5</b>
	7-37/64"	7-44/64"	<b>F96-6</b>	<b>FL96-6</b>
	7-45/64"	7-52/64"	<b>F96-7</b>	<b>FL96-7</b>
	7-53/64"	7-60/64"	<b>F96-8</b>	<b>FL96-8</b>
7-61/64"	8"	<b>F96-9</b>	<b>FL96-9</b>	
8"	8-53/64"	8-56/64"	<b>F128-X</b> <sup>1</sup>	---
	9"	9-9/64"	<b>F128-Y</b>	<b>FL128-Y</b>
	9-20/64"	9-24/64"	<b>F128-1</b>	<b>FL128-1</b>
	9-25/64"	9-32/64"	<b>F128-2</b>	<b>FL128-2</b>
	9-33/64"	9-40/64"	<b>F128-3</b>	<b>FL128-3</b>
	9-41/64"	9-48/64"	<b>F128-4</b>	<b>FL128-4</b>
	9-49/64"	9-56/64"	<b>F128-5</b>	<b>FL128-5</b>
9-57/64"	10"	<b>F128-6</b>	<b>FL128-6</b>	
10-1/64"	10-4/64"	<b>F128-7</b>	<b>FL128-7</b>	
10"	11-32/64"	11-44/64"	<b>F160-1</b>	<b>FL160-1</b>
	11-45/64"	11-60/64"	<b>F160-2</b>	<b>FL160-2</b>
	11-61/64"	12-12/64"	<b>F160-3</b>	<b>FL160-3</b>
	12-13/64"	12-28/64"	<b>F160-4</b>	<b>FL160-4</b>
	12-29/64"	12-44/64"	<b>F160-5</b>	<b>FL160-5</b>
	12-45/64"	12-60/64"	<b>F160-6</b>	<b>FL160-6</b>



long style

<sup>1</sup> requires use with special stems on page 89

- for applications with hose OD ranges not listed, contact Dixon®

## External Swage Ferrules - Light Duty

**Features:**

- for use with standard length stems styles TMR, TPR, and TGR series on pages 88 - 89
- consult Dixon® for die recommendations, go to [dixonvalve.com](http://dixonvalve.com) for specific pressure recommendations

Hose ID	Hose OD		304 Stainless Steel Part #
	From	To	
1½"	1-60/64"	2-12/64"	<b>GAS2334TO</b>
	2-4/64"	2-22/64"	<b>GAS2370TO</b>
2"	2-30/64"	2-44/64"	<b>GAS2709TO</b>
	2-42/64"	2-54/64"	<b>GAS2885TO</b>
3"	3-30/64"	3-46/64"	<b>GAS3760TO</b>
	3-47/64"	3-54/64"	<b>GAS3885TO</b>
4"	4-40/64"	4-47/64"	<b>GAS5010TO</b>

## External Swage High Pressure Couplings

**Applications:**

- Intended for services requiring a fitting to withstand extremely high pressures (up to **3,000 PSI at 70°F [21°C]**) and severe operating conditions including: small and medium size drilling rigs, slim hole applications and core drill, workover, seismograph, water well, blast or shot holes.

**Features:**

- sold as a complete coupling (stem and matching ferrule)
- must provide hose OD when ordering for a properly sized ferrule; make sure both ends of the hose are measured for OD
- must be swaged with 50 Ton or 100 Ton Ram
- API and NPT sizes are interchangeable
- stems are machined from seamless pipe and tubing with specially designed serrations
- ferrules are machined from a heavy wall material incorporating matching serrations

### Stem and Ferrule Complete Assemblies

- an accurate hose OD must be provided to complete the part # and to ensure proper retention

#### Male NPT Thread Coupling Units

Hose ID	NPT Size	Zinc Plated Steel Part #
2"	2"	<b>LM32-*</b>
2½"	2½"	<b>LM40-*</b>
3"	3"	<b>LM48-*</b>

#### Male API Thread Coupling Units

Hose ID	API Size	Zinc Plated Steel Part #
2"	2½"	<b>LM3240-*</b>
2½"	3"	<b>LM4048-*</b>
3"	4"	<b>LM4864-*</b>



## Internal Expansion Coupling System

### Applications:

- Essential in applications requiring maximum flow including: concrete pump hose, plaster and grout hose, oil suction and discharge hose, multi-purpose heavy duty air hose, jetting hose, barge loading hose and bottom loading hose.

### Features:

- maximum flow of media
- reduction of turbulence through hose
- excellent sealing and retention characteristics
- outperforms band clamps
- easy and consistent installation
- only one expansion tool is needed for each hose ID
- available end configurations: male NPT, grooved, others available contact Dixon®

Holedall™ stems and ferrules are specifically designed to be used together as a coupling system. Due to differences in dimensions and tolerances, for safety reasons, do not use other manufacturer's stems or ferrules with Holedall™ products. 

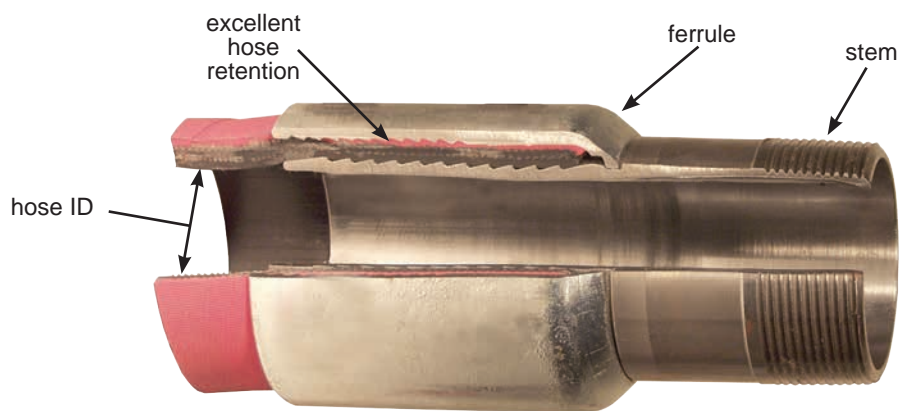

Cross-section of Holedall™ internally expanded assembly

### Male Pipe Threaded End Stems

Size	Working PSI <sup>1</sup>	Carbon Steel Part #
1"	---	<b>IXM16</b>
1¼"	<b>800</b>	<b>IXM20</b>
1½"	<b>800</b>	<b>IXM24</b>
2"	<b>800</b>	<b>IXM32</b>
2½"	<b>600</b>	<b>IXM40</b>
3"	<b>600</b> <sup>2</sup>	<b>IXM48</b>
4"	<b>500</b> <sup>2</sup>	<b>IXM64</b>
6"	<b>400</b>	<b>IXM96</b>



<sup>1</sup> maximum recommended working pressures at **70°F (21°C)** ambient temperature

<sup>2</sup> For hoses which use IXF48-3 to IXF48-5 and IXF64-2 to IXF64-5, consult Dixon® for working pressures. See page 86 for specific recommendations.

### Heavy Duty Raised End Stems

Size	Working PSI <sup>1</sup>	Carbon Steel Part #
1½"	<b>800</b>	<b>IXH24</b>
2"	<b>800</b>	<b>IXH32</b>
2½"	<b>600</b>	<b>IXH40</b>
3"	<b>600</b> <sup>2</sup>	<b>IXH48</b>
4"	<b>500</b> <sup>2</sup>	<b>IXH64</b>



<sup>1</sup> maximum recommended working pressures at **70°F (21°C)** ambient temperature

<sup>2</sup> For hoses which use IXF48-3 to IXF48-5 and IXF64-2 to IXF64-5, consult Dixon® for working pressures. See page 86 for specific recommendations.

**Internal Expansion Coupling System**

**Grooved End Stems**

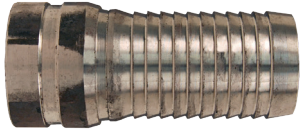

Size	Working PSI <sup>1</sup>	Carbon Steel Part #
1¼"	800	<b>IXV20</b>
1½"	800	<b>IXV24</b>
2"	800	<b>IXV32</b>
2½"	600	<b>IXV40</b>
3"	600 <sup>2</sup>	<b>IXV48</b>
4"	500 <sup>2</sup>	<b>IXV64</b>

<sup>1</sup> maximum recommended working pressures at 70°F (21°C) ambient temperature

<sup>2</sup> For hoses which use IXF48-3 to IXF48-5 and IXF64-2 to IXF64-5, consult Dixon® for working pressures. See page 86 for specific recommendations.

**Internal Expansion Ferrules**



Hose ID	Hose OD		Ferrule ID	Plated Carbon Steel Part #	Hose ID	Hose OD		Ferrule ID	Plated Carbon Steel Part #	
	From	To				From	To			
1"	1-24/64"	1-28/64"	1-7/16"	<b>IXF16-1</b>	3"	3-32/64"	3-36/64"	3-9/16"	<b>IXF48-T</b>	
	1-28/64"	1-32/64"	1-1/2"	<b>IXF16-2</b>		3-36/64"	3-40/64"	3-5/8"	<b>IXF48-U</b>	
	1-32/64"	1-36/64"	1-9/16"	<b>IXF16-3</b>		3-40/64"	3-44/64"	3-11/16"	<b>IXF48-V</b>	
1¼"	1-40/64"	1-44/64"	1-11/16"	<b>IXF20-Z</b>		3-44/64"	3-48/64"	3-3/4"	<b>IXF48-W</b>	
	1-44/64"	1-48/64"	1-3/4"	<b>IXF20-1</b>		3-48/64"	3-52/64"	3-13/16"	<b>IXF48-X</b>	
	1-48/64"	1-52/64"	1-13/16"	<b>IXF20-2</b>		3-52/64"	3-56/64"	3-7/8"	<b>IXF48-Y</b>	
	1-52/64"	1-56/64"	1-7/8"	<b>IXF20-3</b>		3-56/64"	3-60/64"	3-15/16"	<b>IXF48-Z</b>	
	1-56/64"	1-60/64"	1-15/16"	<b>IXF20-4</b>		3-60/64"	4"	4"	<b>IXF48-1</b>	
	1-60/64"	2"	2"	<b>IXF20-5</b>		4"	4-4/64"	4-1/16"	<b>IXF48-2</b>	
	2"	2-4/64"	2-1/16"	<b>IXF20-6</b>		4-4/64"	4-8/64"	4-1/8"	<b>IXF48-3 <sup>1</sup></b>	
1½"	1-56/64"	1-60/64"	1-15/16"	<b>IXF24-Z</b>		4-8/64"	4-12/64"	4-3/16"	<b>IXF48-4 <sup>1</sup></b>	
	1-60/64"	2"	2"	<b>IXF24-1</b>		4-12/64"	4-16/64"	4-1/4"	<b>IXF48-5 <sup>1</sup></b>	
	2"	2-4/64"	2-1/16"	<b>IXF24-2</b>		4"	4-36/64"	4-40/64"	4-5/8"	<b>IXF64-T</b>
	2-4/64"	2-8/64"	2-1/8"	<b>IXF24-3</b>			4-40/64"	4-44/64"	4-11/16"	<b>IXF64-U</b>
	2-8/64"	2-12/64"	2-3/16"	<b>IXF24-4</b>			4-44/64"	4-48/64"	4-3/4"	<b>IXF64-V</b>
	2-12/64"	2-16/64"	2-1/4"	<b>IXF24-5</b>	4-48/64"		4-52/64"	4-13/16"	<b>IXF64-W</b>	
	2-16/64"	2-20/64"	2-5/16"	<b>IXF24-6</b>	4-52/64"		4-56/64"	4-7/8"	<b>IXF64-X</b>	
2-20/64"	2-24/64"	2-3/8"	<b>IXF24-7</b>	4-56/64"	4-60/64"		4-15/16"	<b>IXF64-Y</b>		
2-32/64"	2-36/64"	2-9/16"	<b>IXF32-Y</b>	4-60/64"	5"		5"	<b>IXF64-Z</b>		
2"	2-36/64"	2-40/64"	2-5/8"	<b>IXF32-Z</b>	5"		5-4/64"	5-1/16"	<b>IXF64-1</b>	
	2-40/64"	2-44/64"	2-11/16"	<b>IXF32-1</b>	5-4/64"		5-8/64"	5-1/8"	<b>IXF64-2 <sup>1</sup></b>	
	2-44/64"	2-48/64"	2-3/4"	<b>IXF32-2</b>	5-8/64"		5-12/64"	5-3/16"	<b>IXF64-3 <sup>1</sup></b>	
	2-48/64"	2-52/64"	2-13/16"	<b>IXF32-3</b>	5-12/64"		5-16/64"	5-1/4"	<b>IXF64-4 <sup>1</sup></b>	
	2-52/64"	2-56/64"	2-7/8"	<b>IXF32-4</b>	5-16/64"		5-20/64"	5-5/16"	<b>IXF64-5 <sup>1</sup></b>	
	2-56/64"	2-60/64"	2-15/16"	<b>IXF32-5</b>	6"		6-40/64"	6-44/64"	6-11/16"	<b>IXF96-1</b>
	2-60/64"	3"	3"	<b>IXF32-6</b>			6-44/64"	6-48/64"	6-3/4"	<b>IXF96-2</b>
	3"	3-4/64"	3-1/16"	<b>IXF32-7</b>			6-46/64"	6-50/64"	6-25/32"	<b>IXF96-3</b>
2½"	3-4/64"	3-8/64"	3-1/8"	<b>IXF40-1</b>		6-48/64"	6-52/64"	6-13/16"	<b>IXF96-4</b>	
	3-8/64"	3-12/64"	3-3/16"	<b>IXF40-2</b>		6-52/64"	6-56/64"	6-7/8"	<b>IXF96-5</b>	
	3-12/64"	3-16/64"	3-1/4"	<b>IXF40-3</b>		6-56/64"	6-60/64"	6-15/16"	<b>IXF96-6</b>	
	3-16/64"	3-20/64"	3-5/16"	<b>IXF40-4</b>		6-60/64"	7"	7"	<b>IXF96-7</b>	
	3-20/64"	3-24/64"	3-3/8"	<b>IXF40-5</b>		7"	7-4/64"	7-1/16"	<b>IXF96-8</b>	
	3-24/64"	3-28/64"	3-7/16"	<b>IXF40-6</b>	7-4/64"	7-8/64"	7-1/8"	<b>IXF96-9</b>		
	3-28/64"	3-32/64"	3-1/2"	<b>IXF40-7</b>	7-8/64"	7-12/64"	7-3/16"	<b>IXF96-10</b>		
				<b>IXF40-8</b>	7-12/64"	7-16/64"	7-1/4"	<b>IXF96-11</b>		
				7-16/64"	7-20/64"	7-5/16"	<b>IXF96-12</b>			
				7-18/64"	7-22/64"	7-11/32"	<b>IXF96-13</b>			
				7-20/64"	7-24/64"	7-3/8"	<b>IXF96-14</b>			

<sup>1</sup> for hoses using ferrule sizes IXF48-3 thru IXF48-5 and IXF64-2 thru IXF64-5, consult Dixon® for working pressures

• for use with IX stems on pages 93 - 94



## Scovill Style Couplings

**Applications:**

- recommended for discharge and suction service; commonly used in the transfer of fuel to homes, airplanes, ships, etc.
- intended for fuel delivery service, see page 97 for information on API 1529 certification

**Features:**

- male and female stems are machined from bar stock or solid brass forgings; ferrules are available in brass and stainless steel
- compact, lightweight and streamlined to eliminate catching on curbs and shrubs
- stems and ferrules are designed to be used together as a coupling system
- stem is expanded to nominal ID of hose for a rigid, uniform, full-flow area
- all fittings have octagonal facets for tightening with a wrench; females in 1½" and larger sizes have lugs for tightening
- pre-lubricated for assembly
- designed for internal expansion only
- hand and electrically operated installation equipment is available, consult Dixon® for pricing and availability
- working pressure varies with the size of the fitting, the size and construction of the hose and the media being conveyed, consult Dixon® for recommendations
- do not interchange with other manufacturers 

### Permanent Male Couplings

Size	Thread	Brass Part #
¾"	NPT	<b>H5192</b>
1"	NST	<b>H5212NST</b>
1¼"	NPT	<b>H5222-A</b>
1⅜"	NPT	<b>H5272</b> <sup>1</sup>
1½"	NST	<b>H5232NST</b>
2"	NPT	<b>H5242</b>
2½"	NPT	<b>H5252</b>
3"	NPT	<b>H5262</b>

<sup>1</sup> 1⅜" stem has 1½" thread



### Permanent Female Couplings

Size	Thread	Brass Part #
¾"	NPSH	<b>H5191-BU</b>
1"	NST	<b>H5211NST</b>
1¼"	NPSH	<b>H5221-A-BU</b>
1⅜"	NPSH	<b>H5271-BU</b> <sup>1</sup>
1½"	NST	<b>H5231NST</b> <sup>2</sup>
2"	NPSH	<b>H5241-BU</b>
2½"	NPSH	<b>H5251</b> <sup>3</sup>
3"	NPSH	<b>H5261</b> <sup>3</sup>

<sup>1</sup> 1⅜" stem has 1½" thread

<sup>2</sup> 1½" NST requires special adapter, part # **H5231NSTADT**

<sup>3</sup> 2½" and 3" parts have female NPSM thread



### Permanent Grooved Couplings

Size	Brass Part #
1"	<b>G5212</b>
1½"	<b>G5232</b>
2"	<b>G5242</b>
2½"	<b>G5252</b>



**Scovill Style Series****Ferrules****Features:**

- Eliminates the need for a large stock of coupling bodies. With a wide range of sizes available, you can build the perfect assembly of a coupling to a corresponding hose size with commercial tolerances, regardless of wall thickness
- for use with Scovill style couplings on page 95

Hose ID	Hose OD		Brass Part #
	From	To	
¾"	1-4/64"	1-7/64"	<b>R75AAAS</b>
	1-8/64"	1-11/64"	<b>R75AAS</b>
	1-12/64"	1-14/64"	<b>R75AS</b>
	1-15/64"	1-17/64"	<b>R75BS</b>
	1-18/64"	1-20/64"	<b>R75CS</b>
1⅜"	1-47/64"	1-50/64"	<b>R1375BS</b>
	1-51/64"	1-54/64"	<b>R1375CS</b>
	1-55/64"	1-58/64"	<b>R1375DS</b>
	1-59/64"	1-62/64"	<b>R1375ES</b>
1½"	2-25/64"	2-28/64"	<b>R15GS</b> <sup>1</sup>
2"	2-27/64"	2-30/64"	<b>R2AAS</b>
	2-31/64"	2-34/64"	<b>R2AS</b>
	2-35/64"	2-38/64"	<b>R2BS</b>
	2-39/64"	2-42/64"	<b>R2CS</b>
	2-43/64"	2-46/64"	<b>R2DS</b>
	2-47/64"	2-50/64"	<b>R2ES</b>
	2-51/64"	2-54/64"	<b>R2FS</b>
2½"	2-62/64"	3-1/64"	<b>R25AS</b>
	3-2/64"	3-6/64"	<b>R25BS</b>
	3-7/64"	3-11/64"	<b>R25CS</b>
	3-12/64"	3-16/64"	<b>R25DS</b>
	3-17/64"	3-21/64"	<b>R25ES</b>
	3-22/64"	3-26/64"	<b>R25FS</b>
3"	3-30/64"	3-34/64"	<b>R3AAAS</b>
	3-35/64"	3-39/64"	<b>R3AAS</b>
	3-40/64"	3-45/64"	<b>R3AS</b>
	3-46/64"	3-50/64"	<b>R3BS</b>
	3-51/64"	3-54/64"	<b>R3CS</b>



<sup>1</sup> will be replaced by API ferrules

**API Certified Permanently Attached** Petroleum Male **Couplings**

**Male Couplings**

**Feature:**

- Tested and compliant with API 1529 6th edition. Coupling procedures, ferrule recommendations and API test data are available upon request, please contact Dixon® at [engineering@dixonvalve.com](mailto:engineering@dixonvalve.com).

Size	Thread Type	Brass Part #
1"	NPT	<i>H5212-A</i>
1¼"	NPT	<i>H5222-A</i>
1½"	NPT	<i>H5232-A</i>
2"	NPT	<i>H5242L-A</i>
2½"	NPT	<i>H5252L-A</i>
3"	NPT	<i>H5262L-A</i>
4"	NPT	<i>H5282L-A</i>



Hose Coupling  
Systems

**Female Couplings**

Size	Thread Type	Brass Part #
1"	NPSH	<i>H5211-A-BU</i>
1¼"	NPSH	<i>H5221-A-BU</i>
1½"	NPSH	<i>H5231-A-BU</i>
2"	NPSH	<i>H5241L-A-BU</i>
2½"	NPSM	<i>H5251L-A-BU</i>
3"	NPSM	<i>H5261L-A-BU</i>
4"	NPSM	<i>H5281L-A-BU</i>



**API Certified Series Ferrules**

Hose ID	Hose OD		Brass Part #	304 Stainless Steel Part #
	From	To		
1"	1-24/64"	1-26/64"	<b>R1AAAS-A</b>	---
	1-27/64"	1-29/64"	<b>R1AAS-A</b>	---
	1-30/64"	1-32/64"	<b>R1AS-A</b>	---
	1-33/64"	1-35/64"	<b>R1BS-A</b>	---
	1-36/64"	1-38/64"	<b>R1CS-A</b>	---
	1-39/64"	1-41/64"	<b>R1DS-A</b>	---
	1-42/64"	1-44/64"	<b>R1ES-A</b>	---
1¼"	1-39/64"	1-42/64"	<b>R125AAS-A</b>	---
	1-43/64"	1-46/64"	<b>R125AS-A</b>	---
	1-47/64"	1-50/64"	<b>R125BS-A</b>	---
	1-51/64"	1-54/64"	<b>R125CS-A</b>	---
	1-55/64"	1-58/64"	<b>R125DS-A</b>	---
	1-59/64"	1-62/64"	<b>R125ES-A</b>	---
1½"	1-54/64"	1-57/64"	<b>R15AAAS-A</b>	---
	1-58/64"	1-62/64"	<b>R15AAS-A</b>	---
	1-63/64"	2-2/64"	<b>R15AS-A</b>	---
	2-3/64"	2-6/64"	<b>R15BS-A</b>	---
	2-7/64"	2-11/64"	<b>R15CS-A</b>	---
	2-12/64"	2-14/64"	<b>R15DS-A</b>	---
	2-15/64"	2-19/64"	<b>R15ES-A</b>	---
	2-20/64"	2-24/64"	<b>R15FS-A</b>	---
	2-31/64"	2-34/64"	---	<b>R2ASS-A</b>
2"	2-35/64"	2-38/64"	---	<b>R2BSS-A</b>
	2-39/64"	2-42/64"	---	<b>R2CSS-A</b>
	2-43/64"	2-46/64"	---	<b>R2DSS-A</b>
	2-47/64"	2-50/64"	---	<b>R2ESS-A</b>
	2-62/64"	3-1/64"	---	<b>R25ASS-A</b>
2½"	3-2/64"	3-6/64"	---	<b>R25BSS-A</b>
	3-7/64"	3-11/64"	---	<b>R25CSS-A</b>
	3-12/64"	3-16/64"	---	<b>R25DSS-A</b>
	3-17/64"	3-21/64"	---	<b>R25ESS-A</b>
3"	3-35/64"	3-39/64"	---	<b>R3AASS-A</b>
	3-40/64"	3-45/64"	---	<b>R3ASS-A</b>
	3-46/64"	3-50/64"	---	<b>R3BSS-A</b>
	3-51/64"	3-54/64"	---	<b>R3CSS-A</b>
	3-55/64"	3-59/64"	---	<b>R3DSS-A</b>
4"	4-46/64"	4-48/64"	---	<b>R4ESS-A</b>
	4-49/64"	4-51/64"	---	<b>R4FSS-A</b>
	4-52/64"	4-54/64"	---	<b>R4GSS-A</b>
	4-55/64"	4-57/64"	---	<b>R4HSS-A</b>
	4-58/64"	4-59/64"	---	<b>R4KSS-A</b>
	4-60/64"	4-62/64"	---	<b>R4LSS-A</b>
	4-63/64"	5"	---	<b>R4MSS-A</b>



brass



304 stainless steel



aluminum

- for use with API couplings on page 97

## Female Replacement Washers

### Feature:

- for use with female internally expanded permanent couplings on page 97

Size	Buna Part #
¾"	<b>H5071-BU</b>
1"	<b>H5072-BU</b>
1¼"	<b>H5073-BU</b>
1½"	<b>H5074-BU</b>
2"	<b>H5075-BU</b>
2½"	<b>H5076-BU</b>
3"	<b>H5077-BU</b>
4"	<b>H5078-BU</b>



## HB Coupling Expander Machine

### Features:

- hand operated, pull-through type expander
- for use in a fixed location for small production runs or as a portable repair type expander
- attaches sizes ¾" through 2" of the Scovil style and all sizes of the curb pump fittings
- expander tooling sold separately

Part #
<b>2500HB0000</b>



## Permanent Pump Hose Couplings



### Application:

- economical and trouble-free couplings for gas pump hose

### Features:

- serrations on the stem embed in the hose eliminating wicking and leakage
- shell extends beyond the stem preventing cutting of interior walls; tapered ends of stem and shell protect hose when flexed
- provide tamper-proof static connection which cannot be broken without completely damaging coupling and hose
- internal expansion of stem to nominal ID of hose provides full flow
- broad, firm grip of coupling extends hose life by making it possible for hose to withstand more flexings
- Hand and electrically operated installation equipment is available; consult Dixon® for pricing and availability.
- UL listed
- *Reattach static wire if required.* 

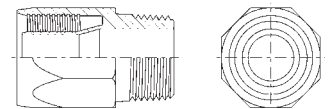

Size	Male NPT	Hose OD	Chrome Plated Brass Part #
¾"	¾"	1-13/64"	<b>H5753</b>
¾"	¾"	1-7/32"	<b>H5754</b>
¾"	¾"	1-17/64"	<b>H5755</b> <sup>1</sup>
1"	1"	1-25/64"	<b>H5771</b>
1"	1"	1-29/64"	<b>H5772</b>
1"	1"	1-1/2"	<b>H5773</b>
1"	1"	1-9/16"	<b>H5774</b>

<sup>1</sup> thrust plate required, part # **2500HTL15**



## Dubl-Grip® Re-attachable Couplings for Curb Pump Hose

### Features:

- two-piece construction
- streamlined design prevents damage to hose and fits well on new pump equipment
- wide, flat surfaces of body threads protect inside of hose from breaking
- tapered surface of sleeve and body cradle hose preventing one-point strain from flexing
- Hose is gripped on its full circumference in two places, ensuring a rigid leakproof connection.
- re-attachable: worn portion of hose can be removed and Dubl-Grip® can be reapplied
- easy assembly:
  - Hose is held in position by sleeve as body is threaded home.
  - Only a wrench is required to assemble the Dubl-Grip®.
- Underwriters Listed approved
- *Reattach static wire if required.*



### Swivel



Hose ID	Male NPT	Hose OD	Chrome Plated Brass Part #
3/4"	3/4"	1 1/8"	<b>H603</b>
3/4"	3/4"	1-13/64"	<b>H604</b>
3/4"	3/4"	1 1/4"	<b>H605</b>
1"	1"	1 3/8"	<b>H609</b> <sup>1</sup>
1"	1"	1-7/16"	<b>H610</b> <sup>1</sup>
1"	1"	1-1/2"	<b>H611</b> <sup>1</sup>

### Non-Swivel



Hose ID	Male NPT	Hose OD	Chrome Plated Brass Part #
5/8"	3/4"	1"	<b>850212</b>
5/8"	3/4"	1-1/32"	<b>850213</b>
3/4"	3/4"	1 1/8"	<b>850451</b>
3/4"	3/4"	1-13/64"	<b>850455</b>
3/4"	3/4"	1 1/4"	<b>850453</b>
1"	1"	1 3/8"	<b>850841</b> <sup>1</sup>
1"	1"	1-7/16"	<b>850801</b> <sup>1</sup>
1"	1"	1 1/2"	<b>850811</b> <sup>1</sup>

<sup>1</sup> octagonal shape

## CIP Internal Expansion (IX) Sanitary Style Hose Couplings

**Application:**

- used in the food, dairy and beverage industries

**Features:**

- Clean-In-Place (CIP) compliant
- Flow Chief internal expansion (IX) fittings are only to be used with Flow Chief stainless steel ferrules.

### Sanitary Style Clamp End Stems

**Features:**

- 3A compliant when assembled by 3A authorized hose shop
- special plug is required to expand CIP compliant fittings
- special adapter plate is required to expand 1½" CIP compliant fittings
- see pages 580 to 583 for sanitary style gaskets
- see pages 564 to 566 for sanitary style clamps

Size	304 Stainless Steel Part #
1½"	<b>IXSE24-3A</b>
2"	<b>IXSE32-3A</b>
3"	<b>IXSE48-3A</b>



Hose Coupling  
Systems

### Special Expansion Plugs for CIP Compliant IX Fitting

Hose Size	304 Stainless Steel Part #
1½"	<b>IXFDPLG137</b>
2"	<b>IXFDPLG187</b>
3"	<b>IXFDPLG287</b>



### CIP Internal Expansion (IX) Sanitary Style Tube Weld End Stem

**Feature:**

- special plug is required to expand CIP compliant fittings

Size	304 Stainless Steel Part #
2"	<b>IXPE32-3A</b>



## Internal Expansion (IX) Sanitary Style Clamp End Stems

**Features:**

- clamp end x hose shank
- Flow Chief internal expansion (IX) fittings are only to be used with Flow Chief stainless steel ferrules.
- see pages 578 - 583 for sanitary style gaskets
- see pages 564 - 566 for sanitary style clamps

Size	304 Stainless Steel Part #
1½"	<b>IXSE24</b>
2"	<b>IXSE32</b>
2½"	<b>IXSE40</b>
3"	<b>IXSE48</b>
4"	<b>IXSE64</b>



## Internal Expansion (IX) Sanitary Style

### Male NPT Stems

**Feature:**

- Flow Chief internal expansion (IX) fittings are only to be used with Flow Chief stainless steel ferrules.



Size	304 Stainless Steel Part #
1½"	<b>IXMS24</b>
2"	<b>IXMS32</b>
2½"	<b>IXMS40</b>
3"	<b>IXMS48</b>
4"	<b>IXMS64</b>

## Internal Expansion (IX) Sanitary Style Bevel Seat Hose Couplings

**Features:**

- Flow Chief internal expansion (IX) fittings are only to be used with Flow Chief stainless steel ferrules.
- see page 593 for bevel seat gaskets

### Bevel Seat Stems

**Feature:**

- only use with the IXAN nuts shown below

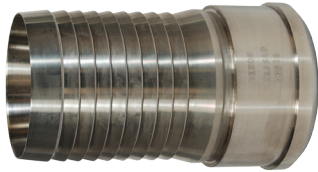

Size	304 Stainless Steel Part #
1½"	<b>IXFS24</b>
2"	<b>IXFS32</b>
2"	<b>IXFS32-3A</b> <sup>1</sup>
2½"	<b>IXFS40</b>
3"	<b>IXFS48</b>
4"	<b>IXFS64</b>

<sup>1</sup> must use plug part # IXFDPLG187

### Bevel Seat Threaded Hex Nuts

#### series 13H (modified)



Size	304 Stainless Steel Part #
1½"	<b>IXAN24</b>
2"	<b>IXAN32</b>
2½"	<b>IXAN40</b>
3"	<b>IXAN48</b>
4"	<b>IXAN64</b>



## Internal Expansion Sanitary Style Flow Chief Ferrules

**Feature:**

- ferrule ID's are designed in increments of 1/16"

Hose ID	Hose OD		304 Stainless Steel Part #
	From	To	
1½" <sup>1</sup>	1-56/64"	1-59/64"	<b>24PFX1.937</b>
	1-60/64"	1-63/64"	<b>24PFX2.000</b>
	2"	2-3/64"	<b>24PFX2.062</b>
	2-4/64"	2-7/64"	<b>24PFX2.125</b>
	2-8/64"	2-11/64"	<b>24PFX2.187</b>
	2-12/64"	2-15/64"	<b>24PFX2.250</b>
	2-16/64"	2-19/64"	<b>24PFX2.312</b> <sup>2</sup>
2" <sup>1</sup>	2-28/64"	2-31/64"	<b>32PFX2.500</b>
	2-32/64"	2-35/64"	<b>32PFX2.562</b>
	2-36/64"	2-39/64"	<b>32PFX2.625</b>
	2-40/64"	2-43/64"	<b>32PFX2.687</b>
	2-44/64"	2-47/64"	<b>32PFX2.750</b>
	2-48/64"	2-51/64"	<b>32PFX2.812</b>
	2-52/64"	2-55/64"	<b>32PFX2.875</b>
	2-56/64"	2-59/64"	<b>32PFX2.937</b>
2½"	3"	3-3/64"	<b>40PFX3.062</b>
	3-4/64"	3-7/64"	<b>40PFX3.125</b>
	3-8/64"	3-11/64"	<b>40PFX3.187</b>
	3-12/64"	3-15/64"	<b>40PFX3.250</b>
	3-16/64"	3-19/64"	<b>40PFX3.312</b>
	3-20/64"	3-23/64"	<b>40PFX3.375</b>
	3-28/64"	3-31/64"	<b>40PFX3.500</b>
3"	3-32/64"	3-35/64"	<b>48PFX3.562</b>
	3-36/64"	3-39/64"	<b>48PFX3.625</b>
	3-40/64"	3-43/64"	<b>48PFX3.687</b>
	3-44/64"	3-47/64"	<b>48PFX3.750</b>
	3-48/64"	3-51/64"	<b>48PFX3.812</b>
	3-52/64"	3-55/64"	<b>48PFX3.875</b>
	3-56/64"	3-59/64"	<b>48PFX3.937</b>
	3-60/64"	3-63/64"	<b>48PFX4.000</b>
	4"	4-3/64"	<b>48PFX4.062</b>
	4-4/64"	4-7/64"	<b>48PFX4.125</b>
4"	4-36/64"	4-39/64"	<b>64PFX4.625</b>
	4-40/64"	4-43/64"	<b>64PFX4.687</b>
	4-44/64"	4-47/64"	<b>64PFX4.750</b>
	4-48/64"	4-51/64"	<b>64PFX4.812</b>
	4-52/64"	4-55/64"	<b>64PFX4.875</b>
	4-56/64"	4-59/64"	<b>64PFX4.937</b>



<sup>1</sup> 1½" and 2" ferrules do not have serrations on the ID

<sup>2</sup> consult Dixon® at [engineering@dixonvalve.com](mailto:engineering@dixonvalve.com) for working pressure

- for use with IX stems on pages 101 and 102

**Dixon Sanitary King Crimp™ Stem**

Clamp End x Hose Shank

**Features:**

- to be used with King Crimp™ sleeves and / or ferrules see pages 111-114
- wetted surfaces meet governmental and independent regulatory standards only

**Tri-Clover Stems**

Size	316 Stainless Steel Part #
1"	<b>CSSR100CS</b>
1½"	<b>CSSR150CS</b>
2"	<b>CSSR200CS</b>
3"	<b>CSSR300CS</b>
4"	<b>CSSR400CS</b>

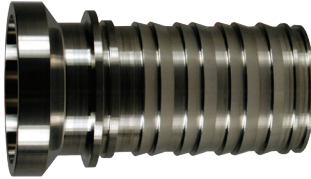
**Female I-line**

Size	316 Stainless Steel Part #
1"	<b>CILR100CS</b>
1½"	<b>CILR150CS</b>
2"	<b>CILR200CS</b>
3"	<b>CILR300CS</b>
4"	<b>CILR400CS</b>

## Dixon Sanitary Style Crimp Stems

### Clamp End x Hose Shank

**Features:**

- sanitary style end
- Dixon® sanitary crimp stems are only to be used with Dixon® sanitary stainless steel crimp ferrules on page 106
- reference [dixonvalve.com](http://dixonvalve.com) for crimp recommendations

Size	316 Stainless Steel Part #
1"	<b>CSSR100-3A</b>
1½"	<b>CSSR150-3A</b>
2"	<b>CSSR200-3A</b>
2½"	<b>CSSR250</b>
3"	<b>CSSR300-3A</b>
4"	<b>CSSR400</b>



Hose Coupling Systems

### Female I-Line End x Hose Shank

- to be used with Sanitary ferrules on page 106

Size	316 Stainless Steel Part #
1½"	<b>CILR150</b>
2"	<b>CILR200</b>
3"	<b>CILR300</b>
4"	<b>CILR400</b>



### Bevel Seat End x Hose Shank

- to be used with Sanitary ferrules on page 106

Size	Nut Used	316 Stainless Steel Part #
1"	13H-G100	<b>CBSR100</b>
1½"	IXAN24	<b>CBSR150</b>
2"	IXAN32	<b>CBSR200</b>
3"	IXAN300	<b>CBSR300</b>
4"	IXAN64	<b>CBSR400</b>

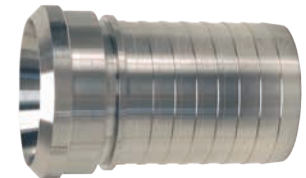

### Tube Weld End x Hose Shank

- to be used with Sanitary ferrules on page 106

Size	316 Stainless Steel Part #
1½"	<b>CTER150</b>
2"	<b>CTER200</b>
3"	<b>CTER300</b>
4"	<b>CTER400</b>



**Dixon® Sanitary Style****Crimp Ferrules****Features:**

- AISI 304 stainless steel
- ferrules have a surface finish of 63 or better

Size	Hose OD		304 Stainless Steel Part #
	From	To	
1"	1-26/64"	1-28/64"	<b>F16G-1453</b>
	1-29/64"	1-31/64"	<b>F16G-1500</b>
	1-32/64"	1-34/64"	<b>F16G-1547</b>
	1-35/64"	1-37/64"	<b>F16G-1594</b>
	1-38/64"	1-40/64"	<b>F16G-1641</b>
1½"	1-58/64"	1-61/64"	<b>F24G-1969</b>
	1-62/64"	2-1/64"	<b>F24G-2031</b>
	2-2/64"	2-5/64"	<b>F24G-2094</b>
	2-6/64"	2-9/64"	<b>F24G-2156</b>
	2-10/64"	2-13/64"	<b>F24G-2219</b>
	2-14/64"	2-17/64"	<b>F24G-2281</b>
	2-18/64"	2-21/64"	<b>F24G-2344</b>
2"	2-30/64"	2-33/64"	<b>F32G-2531</b>
	2-34/64"	2-37/64"	<b>F32G-2594</b>
	2-38/64"	2-41/64"	<b>F32G-2656</b>
	2-42/64"	2-45/64"	<b>F32G-2719</b>
	2-52/64"	2-55/64"	<b>F32G-2875</b>
	2-56/64"	2-59/64"	<b>F32G-2938</b>
2½"	3"	3-3/64"	<b>F40G-3063</b>
	3-4/64"	3-7/64"	<b>F40G-3125</b>
	3-8/64"	3-11/64"	<b>F40G-3188</b>
	3-12/64"	3-15/64"	<b>F40G-3250</b>
	3-16/64"	3-19/64"	<b>F40G-3313</b>
	3-20/64"	3-23/64"	<b>F40G-3375</b>
3"	3-36/64"	3-39/64"	<b>F48G-3625</b>
	3-40/64"	3-43/64"	<b>F48G-3688</b>
	3-44/64"	3-47/64"	<b>F48G-3750</b>
	3-48/64"	3-51/64"	<b>F48G-3813</b>
	3-52/64"	3-55/64"	<b>F48G-3875</b>
	3-56/64"	3-59/64"	<b>F48G-3938</b>
4"	3-61/64"	4"	<b>F48G-4016</b>
	4-40/64"	4-43/64"	<b>F64G-4688</b>
	4-44/64"	4-47/64"	<b>F64G-4750</b>
	4-48/64"	4-51/64"	<b>F64G-4813</b>
	4-52/64"	4-55/64"	<b>F64G-4875</b>
	4-56/64"	4-59/64"	<b>F64G-4938</b>
	5-5/64"	5-8/64"	<b>F64G-5141</b>

**Holedall™ DIN External****Crimp Female Stems**

Size	DIN	316 Stainless Steel Part #
1½"	40	<b>HA0240</b>
2"	50	<b>HA0241</b>
2½"	65	<b>HA0242</b>
3"	80	<b>HA0243</b>

**Male Stems**

Size	DIN	316 Stainless Steel Part #
1½"	40	<b>HA0235</b>
2"	50	<b>HA0236</b>
2½"	65	<b>HA0237</b>
3"	80	<b>HA0238</b>

- please visit [dixonvalve.com](http://dixonvalve.com) for crimp recommendations

## Crimp Working Pressure Chart

Size	Temperature	Fitting	Clamp	Working Pressure PSIG	Size	Temperature	Fitting	Clamp	Working Pressure PSIG
1"	Ambient	STC10CS	sleeve	400	3"	Ambient	STC35CS	sleeve	200
	160°F (71°C)	STC10CS	sleeve	270		160°F (71°C)	STC35CS	sleeve	140
	180°F (82°C)	STC10CS	sleeve	250		180°F (82°C)	STC35CS	sleeve	100
	250°F (121°C)	STC10CS	sleeve	200		250°F (121°C)	STC35CS	sleeve	75
	Ambient	STC10CS	ferrule	400		Ambient	STC35CS	ferrule	300
	160°F (71°C)	STC10CS	ferrule	270		160°F (71°C)	STC35CS	ferrule	218
	180°F (82°C)	STC10CS	ferrule	250		180°F (82°C)	STC35CS	ferrule	200
	250°F (121°C)	STC10CS	ferrule	200		250°F (121°C)	STC35CS	ferrule	100
	Ambient	100-C/E	sleeve	250		Ambient	300-C/E	sleeve	125
	160°F (71°C)	100-C/E	sleeve	242		160°F (71°C)	300-C/E	sleeve	100
	180°F (82°C)	100-C/E	sleeve	240		180°F (82°C)	300-C/E	sleeve	60
	250°F (121°C)	100-C/E	sleeve	200		250°F (121°C)	300-C/E	sleeve	55
	Ambient	100-C/E	ferrule	250		Ambient	300-C/E	ferrule	150
	160°F (71°C)	100-C/E	ferrule	242		160°F (71°C)	300-C/E	ferrule	125
	180°F (82°C)	100-C/E	ferrule	240		180°F (82°C)	300-C/E	ferrule	100
	250°F (121°C)	100-C/E	ferrule	200		250°F (121°C)	300-C/E	ferrule	75
1½"	Ambient	STC20CS	sleeve	300	4"	Ambient	STC40CS	sleeve	175
	160°F (71°C)	STC20CS	sleeve	225		160°F (71°C)	STC40CS	sleeve	100
	180°F (82°C)	STC20CS	sleeve	200		180°F (82°C)	STC40CS	sleeve	100
	250°F (121°C)	STC20CS	sleeve	100		250°F (121°C)	STC40CS	sleeve	50
	Ambient	STC20CS	ferrule	350		Ambient	STC40CS	ferrule	300
	160°F (71°C)	STC20CS	ferrule	225		160°F (71°C)	STC40CS	ferrule	218
	180°F (82°C)	STC20CS	ferrule	200		180°F (82°C)	STC40CS	ferrule	200
	250°F (121°C)	STC20CS	ferrule	150		250°F (121°C)	STC40CS	ferrule	100
	Ambient	150-C/E	sleeve	250		Ambient	400-C/E	sleeve	110
	160°F (71°C)	150-C/E	sleeve	200		160°F (71°C)	400-C/E	sleeve	75
	180°F (82°C)	150-C/E	sleeve	100		180°F (82°C)	400-C/E	sleeve	60
	250°F (121°C)	150-C/E	sleeve	75		250°F (121°C)	400-C/E	sleeve	50
	Ambient	150-C/E	ferrule	250		Ambient	400-C/E	ferrule	150
	160°F (71°C)	150-C/E	ferrule	200		160°F (71°C)	400-C/E	ferrule	75
	180°F (82°C)	150-C/E	ferrule	150		180°F (82°C)	400-C/E	ferrule	75
	250°F (121°C)	150-C/E	ferrule	100		250°F (121°C)	400-C/E	ferrule	75
2"	Ambient	STC25CS	sleeve	250	6"	Ambient	STC60CS	sleeve	75
	160°F (71°C)	STC25CS	sleeve	150		160°F (71°C)	STC60CS	sleeve	---
	180°F (82°C)	STC25CS	sleeve	125		180°F (82°C)	STC60CS	sleeve	---
	250°F (121°C)	STC25CS	sleeve	80		250°F (121°C)	STC60CS	sleeve	---
	Ambient	STC25CS	ferrule	300		Ambient	STC60CS	ferrule	230
	160°F (71°C)	STC25CS	ferrule	239		160°F (71°C)	STC60CS	ferrule	---
	180°F (82°C)	STC25CS	ferrule	225		180°F (82°C)	STC60CS	ferrule	---
	250°F (121°C)	STC25CS	ferrule	100		250°F (121°C)	STC60CS	ferrule	---
	Ambient	200-C/E	sleeve	250		Ambient	600-C/E	sleeve	75
	160°F (71°C)	200-C/E	sleeve	100		160°F (71°C)	600-C/E	sleeve	---
	180°F (82°C)	200-C/E	sleeve	50		180°F (82°C)	600-C/E	sleeve	---
	250°F (121°C)	200-C/E	sleeve	50		250°F (121°C)	600-C/E	sleeve	---
	Ambient	200-C/E	ferrule	250		Ambient	600-C/E	ferrule	75
	160°F (71°C)	200-C/E	ferrule	100		160°F (71°C)	600-C/E	ferrule	---
	180°F (82°C)	200-C/E	ferrule	100		180°F (82°C)	600-C/E	ferrule	---
	250°F (121°C)	200-C/E	ferrule	100		250°F (121°C)	600-C/E	ferrule	---

**Dixon® Cam & Groove Type C Coupler x Hose Shank**

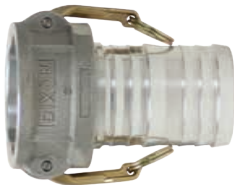

356T6 aluminum

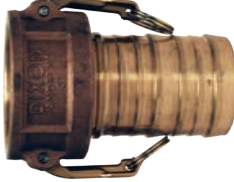

brass



316 stainless steel



unplated ductile iron

**Features:**

- finger rings are not supplied on 1" Dixon® couplings
- couplers are supplied standard with a Buna-N gasket, other gasket types are available on pages 167 - 170
- ½" Dixon® coupler has only one cam arm
- use Dixon® replacement handles only

Hose ID	356T6 Aluminum Part #	Brass Part #	316 Stainless Steel Part #	Unplated Ductile Iron Part #
1"	100-C-AL	100-C-BR	100-C-SS	---
1½"	150-C-AL	150-C-BR	150-C-SS	150-C-MI
2"	200-C-AL	200-C-BR	200-C-SS	200-C-MI
3"	300-C-AL	300-C-BR	300-C-SS	300-C-MI <sup>1</sup>
4"	400-C-AL	400-C-BR	400-C-SS	400-C-MI <sup>1</sup>
6"	600-C-AL	600-C-BR	600-C-SS	600-C-MI <sup>1</sup>

<sup>1</sup> ductile iron

**Only use the crimp style shanks with the crimp style sleeves and ferrules.**  
 Due to differences in dimensions and tolerances for safety reasons, do not interchange other manufacturer's products with Dixon® products.



**EZ Boss-Lock™ Cam & Groove Type C Coupler x Hose Shank**

**Feature:**

- couplers are supplied standard with a Buna-N gasket, other gasket types are available on pages 167 - 170



Size	316 Stainless Steel Part #
1"	RC100EZCR
1¼"	RC125EZCR
1½"	RC150EZCR
2"	RC200EZCR
3"	RC300EZCR
4"	RC400EZCR
6"	RC600EZCR

Under no circumstances should the EZ Boss-Lock™ cam arms be used on any fitting not specifically designed for their use. See page 122 for further specifications.



**Dixon® Type E Adapters**

male adapter x hose shank



Pressure rating is based on the seal of the mating part. See ratings on page 124

Hose ID	356T6 Aluminum Part #	Brass Part #	316 Stainless Steel Part #	Unplated Ductile Iron Part #
1"	<b>100-E-AL</b>	<b>100-E-BR</b>	<b>100-E-SS</b>	---
1½"	<b>150-E-AL</b>	<b>150-E-BR</b>	<b>150-E-SS</b>	---
2"	<b>200-E-AL</b>	<b>200-E-BR</b>	<b>200-E-SS</b>	---
3"	<b>300-E-AL</b>	<b>300-E-BR</b>	<b>300-E-SS</b>	<b>300-E-MI</b>
4"	<b>400-E-AL</b>	<b>400-E-BR</b>	<b>400-E-SS</b>	<b>400-E-MI</b>
6"	<b>600-E-AL</b>	<b>600-E-BR</b>	<b>600-E-SS</b>	<b>600-E-MI</b>



356T6 aluminum

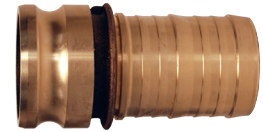

brass



316 stainless steel



unplated ductile iron

Hose Coupling  
Systems**Global Crimp Style Cam & Groove Type C Coupler x Hose Shank****Features:**

- all couplers are supplied with safety clips
- couplers are supplied standard with a Buna-N gasket, other gasket types are available on pages 167 - 170
- use Global replacement handles only



Only use the crimp style shanks with the crimp style sleeves and ferrules.  
Due to differences in dimensions and tolerances for safety reasons, do not interchange other manufacturer's products with Dixon® products.

Hose ID	A380 Permanent Mold Aluminum Part #	C38000 Forged Brass Part #	316 Investment Cast Stainless Part #
1"	<b>G100-C-ALCR</b>	<b>G100-C-BRCR</b>	<b>G100-C-SSCR</b>
1½"	<b>G150-C-ALCR</b>	<b>G150-C-BRCR</b>	<b>G150-C-SSCR</b>
2"	<b>G200-C-ALCR</b>	<b>G200-C-BRCR</b>	<b>G200-C-SSCR</b>
3"	<b>G300-C-ALCR</b>	<b>G300-C-BRCR</b>	<b>G300-C-SSCR</b>
4"	<b>G400-C-ALCR</b>	<b>G400-C-BRCR</b>	<b>G400-C-SSCR</b>
6"	<b>G600-C-ALCR</b>	---	<b>G600-C-SSCR</b>



A380 permanent mold aluminum



C38000 forged brass



316 investment cast stainless

**Global Crimp Style Cam & Groove Type E Adapter x Hose Shank**

Hose Coupling Systems



A380 permanent mold aluminum



C38000 forged brass

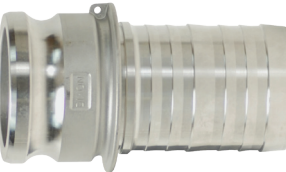

316 investment cast stainless

**Only use the crimp style shanks with the crimp style sleeves and ferrules.**  
 Due to differences in dimensions and tolerances for safety reasons, do not interchange other manufacturer's products with Dixon® products. Pressure rating is based on the seal of the mating part. See ratings on page 124.



Hose ID	A380 Permanent Mold Aluminum Part #	C38000 Forged Brass Part #	316 Investment Cast Stainless Steel Part #
1"	<b>G100-E-ALCR</b>	<b>G100-E-BRCR</b>	<b>G100-E-SSCR</b>
1½"	<b>G150-E-ALCR</b>	<b>G150-E-BRCR</b>	<b>G150-E-SSCR</b>
2"	<b>G200-E-ALCR</b>	<b>G200-E-BRCR</b>	<b>G200-E-SSCR</b>
3"	<b>G300-E-ALCR</b>	<b>G300-E-BRCR</b>	<b>G300-E-SSCR</b>
4"	<b>G400-E-ALCR</b>	<b>G400-E-BRCR</b>	<b>G400-E-SSCR</b>
6"	<b>G600-E-ALCR</b>	---	<b>G600-E-SSCR</b>

**Boss™ Ground Joint Stems**

**Only use the crimp style shanks with the crimp style sleeves and ferrules.**  
 Due to differences in dimensions and tolerances for safety reasons, do not interchange other manufacturer's products with Dixon® products. Pressure rating is based on the seal of the mating part. See ratings on page 124.



Hose Shank x NPT	Plated Steel and / or Iron Part #	Opt Qty
2"	<b>GB26</b>	10
3"	<b>GB36</b>	5

- GB26 and GB36 has a machined shank to accept a Boss™ clamp, King Crimp™ sleeve or a ferrule

The King Crimp™ sleeve and ferrule are not intended for steam service.





## King Crimp™ Style Sleeves

- Only use the crimp style shanks with the crimp style sleeves and ferrules. Due to differences in dimensions and tolerances for safety reasons, do not interchange other manufacturer's products with Dixon® products.
- for liquid service only
- not intended for steam service



Hose ID	Hose OD		Work. Pressure (PSI)		Sleeve ID	Sleeve Wall Thick.	Sleeve Overall Length	Carbon Steel Part #	304 Stainless Steel Part #	Aluminum Part #
	From	To	cam & groove <sup>1</sup>	King Crimp nipple <sup>2</sup>						
1"	1-13/64"	1-16/64"	*	*	1.313"	.062"	2½"	CS100-1CS	CS100-1SS	---
	1-17/64"	1-20/64"	*	*	1.375"	.062"	2½"	CS100-2CS	CS100-2SS	CS100-2AL
	1-21/64"	1-24/64"	*	*	1.438"	.062"	2½"	CS100-3CS	CS100-3SS	---
	1-25/64"	1-28/64"	*	*	1.500"	.062"	2½"	CS100-4CS	CS100-4SS	CS100-4AL
	1-29/64"	1-32/64"	*	*	1.563"	.062"	2½"	CS100-5CS	CS100-5SS	---
	1-33/64"	1-36/64"	*	*	1.625"	.062"	2½"	CS100-6CS	CS100-6SS	CS100-6AL
	1-37/64"	1-40/64"	*	*	1.688"	.062"	2½"	CS100-7CS	CS100-7SS	---
	1-41/64"	1-44/64"	*	*	1.750"	.062"	2½"	CS100-8CS	CS100-8SS	---
	1-45/64"	1-48/64"	*	*	1.813"	.062"	2½"	CS100-9CS	CS100-9SS	---
	1-49/64"	1-52/64"	*	*	1.875"	.062"	2½"	CS100-10CS	CS100-10SS	---
1¼"	1-41/64"	1-44/64"	250	300	1.750"	.060"	2-5/8"	CS125-3CS	CS125-3SS	---
	1-45/64"	1-48/64"	250	300	1.813"	.060"	2-5/8"	CS125-4CS	CS125-4SS	---
	1-49/64"	1-52/64"	250	300	1.875"	.060"	2-5/8"	CS125-5CS	CS125-5SS	---
	1-53/64"	1-56/64"	250	300	1.938"	.060"	2-5/8"	CS125-6CS	CS125-6SS	---
1½"	1-41/64"	1-44/64"	250	300	1.750"	.062"	2½"	CS150-1CS	CS150-1SS	---
	1-45/64"	1-48/64"	250	300	1.813"	.062"	2½"	CS150-2CS	CS150-2SS	---
	1-49/64"	1-52/64"	250	300	1.875"	.062"	2½"	CS150-3CS	CS150-3SS	CS150-3AL
	1-53/64"	1-56/64"	250	300	1.938"	.062"	2½"	CS150-4CS	CS150-4SS	---
	1-57/64"	1-60/64"	250	300	2.000"	.062"	2½"	CS150-5CS	CS150-5SS	---
	1-61/64"	2"	250	300	2.063"	.062"	2½"	CS150-6CS	CS150-6SS	---
	2-1/64"	2-4/64"	250	300	2.125"	.062"	2½"	CS150-7CS	CS150-7SS	CS150-7AL
	2-5/64"	2-8/64"	250	300	2.188"	.062"	2½"	CS150-8CS	CS150-8SS	---
	2-9/64"	2-12/64"	250	300	2.250"	.062"	2½"	CS150-9CS	CS150-9SS	---
	2-13/64"	2-16/64"	250	300	2.313"	.062"	2½"	CS150-10CS	CS150-10SS	---
2-17/64"	2-20/64"	250	300	2.375"	.062"	2½"	CS150-11CS	CS150-11SS	---	
2-21/64"	2-24/64"	250	300	2.438"	.062"	2½"	CS150-12CS	CS150-12SS	---	
2"	2-13/64"	2-16/64"	250	250	2.313"	.062"	2-7/8"	CS200-1CS	CS200-1SS	---
	2-17/64"	2-20/64"	250	250	2.375"	.062"	2-7/8"	CS200-2CS	CS200-2SS	---
	2-21/64"	2-24/64"	250	250	2.438"	.062"	2-7/8"	CS200-3CS	CS200-3SS	---
	2-25/64"	2-28/64"	250	250	2.500"	.062"	2-7/8"	CS200-4CS	CS200-4SS	CS200-4AL
	2-29/64"	2-32/64"	250	250	2.563"	.062"	2-7/8"	CS200-5CS	CS200-5SS	NEW CS200-5AL
	2-33/64"	2-36/64"	250	250	2.625"	.062"	2-7/8"	CS200-6CS	CS200-6SS	---
	2-37/64"	2-40/64"	250	250	2.688"	.062"	2-7/8"	CS200-7CS	CS200-7SS	---
	2-41/64"	2-44/64"	250	250	2.750"	.062"	2-7/8"	CS200-8CS	CS200-8SS	---
	2-45/64"	2-48/64"	250	250	2.813"	.062"	2-7/8"	CS200-9CS	CS200-9SS	---
	2-49/64"	2-52/64"	250	250	2.875"	.062"	2-7/8"	CS200-10CS	CS200-10SS	CS200-10AL
	2-53/64"	2-56/64"	250	250	2.938"	.062"	2-7/8"	CS200-11CS	CS200-11SS	NEW CS200-11AL
	2-57/64"	2-60/64"	250	250	3.000"	.062"	2-7/8"	CS200-12CS	CS200-12SS	NEW CS200-12AL

\* consult Dixon® at [engineering@dixonvalve.com](mailto:engineering@dixonvalve.com) for pressure rating

<sup>1</sup> based on using crimp cam & groove shanks

<sup>2</sup> based on using King™ crimp nipples

## King Crimp™ Style Sleeves



- Only use the crimp style shanks with the crimp style sleeves and ferrules. Due to differences in dimensions and tolerances for safety reasons, do not interchange other manufacturer's products with Dixon® products.
- for liquid service only
- not intended for steam service



Hose ID	Hose OD		Work. Pressure (PSI)		Sleeve ID	Sleeve Wall Thick.	Sleeve Overall Length	Carbon Steel Part #	304 Stainless Steel Part #	Aluminum Part #
	From	To	cam & groove <sup>1</sup>	King Crimp nipple <sup>2</sup>						
3"	3-13/64"	3-16/64"	125	200	3.313"	.090"	3¾"	CS300-1CS	CS300-1SS	---
	3-17/64"	3-20/64"	125	200	3.375"	.090"	3¾"	CS300-2CS	CS300-2SS	---
	3-21/64"	3-24/64"	125	200	3.438"	.090"	3¾"	CS300-3CS	CS300-3SS	---
	3-25/64"	3-28/64"	125	200	3.500"	.090"	3¾"	CS300-4CS	CS300-4SS	---
	3-29/64"	3-32/64"	125	200	3.563"	.090"	3¾"	CS300-5CS	CS300-5SS	CS300-5AL
	3-33/64"	3-36/64"	125	200	3.625"	.090"	3¾"	CS300-6CS	CS300-6SS	---
	3-37/64"	3-40/64"	125	200	3.688"	.090"	3¾"	CS300-7CS	CS300-7SS	---
	3-41/64"	3-44/64"	125	200	3.750"	.090"	3¾"	CS300-8CS	CS300-8SS	CS300-8AL
	3-45/64"	3-48/64"	125	200	3.813"	.090"	3¾"	CS300-9CS	CS300-9SS	---
	3-49/64"	3-52/64"	125	200	3.875"	.090"	3¾"	CS300-10CS	CS300-10SS	NEW CS300-10AL
	3-53/64"	3-56/64"	125	200	3.938"	.090"	3¾"	CS300-11CS	CS300-11SS	---
	3-57/64"	3-60/64"	125	200	4.000"	.090"	3¾"	CS300-12CS	CS300-12SS	CS300-12AL
	3-61/64"	4"	125	200	4.063"	.090"	3¾"	CS300-13CS	CS300-13SS	---
	4-1/64"	4-4/64"	125	200	4.125"	.090"	3¾"	CS300-14CS	CS300-14SS	---
	4-5/64"	4-8/64"	125	200	4.188"	.090"	3¾"	CS300-15CS	CS300-15SS	---
	4-9/64"	4-12/64"	125	200	4.250"	.090"	3¾"	CS300-16CS	CS300-16SS	---
4"	4-13/64"	4-16/64"	110	175	4.313"	.090"	3¾"	CS400-1CS	CS400-1SS	---
	4-17/64"	4-20/64"	110	175	4.375"	.090"	3¾"	CS400-2CS	CS400-2SS	---
	4-21/64"	4-24/64"	110	175	4.438"	.090"	3¾"	CS400-3CS	CS400-3SS	---
	4-25/64"	4-28/64"	110	175	4.500"	.090"	3¾"	CS400-4CS	CS400-4SS	---
	4-29/64"	4-32/64"	110	175	4.563"	.090"	3¾"	CS400-5CS	CS400-5SS	---
	4-33/64"	4-36/64"	110	175	4.625"	.090"	3¾"	CS400-6CS	CS400-6SS	---
	4-37/64"	4-40/64"	110	175	4.688"	.090"	3¾"	CS400-7CS	CS400-7SS	---
	4-41/64"	4-44/64"	110	175	4.750"	.090"	3¾"	CS400-8CS	CS400-8SS	---
	4-45/64"	4-48/64"	110	175	4.813"	.090"	3¾"	CS400-9CS	CS400-9SS	---
	4-49/64"	4-52/64"	110	175	4.875"	.090"	3¾"	CS400-10CS	CS400-10SS	CS400-10AL
	4-53/64"	4-56/64"	110	175	4.938"	.090"	3¾"	CS400-11CS	CS400-11SS	NEW CS400-11AL
	4-57/64"	4-60/64"	110	175	5.000"	.090"	3¾"	CS400-12CS	CS400-12SS	CS400-12AL
	4-61/64"	5"	110	175	5.063"	.090"	3¾"	CS400-13CS	CS400-13SS	---
	5-1/64"	5-4/64"	110	175	5.125"	.090"	3¾"	CS400-14CS	CS400-14SS	---
	5-5/64"	5-8/64"	110	175	5.188"	.090"	3¾"	CS400-15CS	CS400-15SS	---
	5-9/64"	5-12/64"	110	175	5.250"	.090"	3¾"	CS400-16CS	CS400-16SS	---
6"	6-21/64"	6-28/64"	*	*	6.500"	.120"	5½"	CS600-1CS	CS600-1SS	---
	6-29/64"	6-36/64"	*	*	6.625"	.120"	5½"	CS600-2CS	CS600-2SS	---
	6-37/64"	6-44/64"	*	*	6.750"	.120"	5½"	CS600-3CS	CS600-3SS	---
	6-45/64"	6-52/64"	*	*	6.875"	.120"	5½"	CS600-4CS	CS600-4SS	---
	6-53/64"	6-60/64"	*	*	7.000"	.120"	5½"	CS600-5CS	CS600-5SS	---
	6-61/64"	7-4/64"	*	*	7.125"	.120"	5½"	CS600-6CS	CS600-6SS	---
	7-5/64"	7-12/64"	*	*	7.250"	.120"	5½"	CS600-7CS	CS600-7SS	---
	7-13/64"	7-20/64"	*	*	7.375"	.120"	5½"	CS600-8CS	CS600-8SS	---
	7-21/64"	7-28/64"	*	*	7.500"	.120"	5½"	CS600-9CS	CS600-9SS	---

\* consult Dixon® at [engineering@dixonvalve.com](mailto:engineering@dixonvalve.com) for pressure rating

<sup>1</sup> based on using crimp cam & groove shanks

<sup>2</sup> based on using King™ crimp nipples

## King Crimp™ Style Ferrules

Only use the crimp style shanks with the crimp style sleeves and ferrules. Due to differences in dimensions and tolerances for safety reasons, do not interchange other manufacturer's products with Dixon® products.



Hose ID	Hose OD		Work. Pressure (PSI)		Ferrule ID	Ferrule Wall Thickness	Ferrule Overall Length	Carbon Steel Part #	304 Stainless Steel Part #
	From	To	cam & groove <sup>1</sup>	King Crimp nipple <sup>2</sup>					
1"	1-13/64"	1-16/64"	*	*	1.313"	.062"	2-13/16"	<b>CF100-1CS</b>	<b>CF100-1SS</b>
	1-17/64"	1-20/64"	*	*	1.375"	.062"	2-13/16"	<b>CF100-2CS</b>	<b>CF100-2SS</b>
	1-21/64"	1-24/64"	*	*	1.438"	.062"	2-13/16"	<b>CF100-3CS</b>	<b>CF100-3SS</b>
	1-25/64"	1-28/64"	*	*	1.500"	.062"	2-13/16"	<b>CF100-4CS</b>	<b>CF100-4SS</b>
	1-29/64"	1-32/64"	*	*	1.563"	.062"	2-13/16"	<b>CF100-5CS</b>	<b>CF100-5SS</b>
	1-33/64"	1-36/64"	*	*	1.625"	.062"	2-13/16"	<b>CF100-6CS</b>	<b>CF100-6SS</b>
	1-37/64"	1-40/64"	*	*	1.688"	.062"	2-13/16"	<b>CF100-7CS</b>	<b>CF100-7SS</b>
	1-41/64"	1-44/64"	*	*	1.750"	.062"	2-13/16"	<b>CF100-8CS</b>	<b>CF100-8SS</b>
	1-45/64"	1-48/64"	*	*	1.813"	.062"	2-13/16"	<b>CF100-9CS</b>	<b>CF100-9SS</b>
	1-49/64"	1-52/64"	*	*	1.875"	.062"	2-13/16"	<b>CF100-10CS</b>	<b>CF100-10SS</b>
1¼"	1-41/64"	1-44/64"	250	350	1.750"	.060"	2-13/16"	<b>CF125-3CS</b>	<b>CF125-3SS</b>
	1-45/64"	1-48/64"	250	350	1.813"	.060"	2-13/16"	<b>CF125-4CS</b>	<b>CF125-4SS</b>
	1-49/64"	1-52/64"	250	350	1.875"	.060"	2-13/16"	<b>CF125-5CS</b>	<b>CF125-5SS</b>
	1-53/64"	1-56/64"	250	350	1.938"	.060"	2-13/16"	<b>CF125-6CS</b>	<b>CF125-6SS</b>
	1-41/64"	1-44/64"	250	350	1.750"	.062"	2-13/16"	<b>CF150-1CS</b>	<b>CF150-1SS</b>
1½"	1-45/64"	1-48/64"	250	350	1.813"	.062"	2-13/16"	<b>CF150-2CS</b>	<b>CF150-2SS</b>
	1-49/64"	1-52/64"	250	350	1.875"	.062"	2-13/16"	<b>CF150-3CS</b>	<b>CF150-3SS</b>
	1-53/64"	1-56/64"	250	350	1.938"	.062"	2-13/16"	<b>CF150-4CS</b>	<b>CF150-4SS</b>
	1-57/64"	1-60/64"	250	350	2.000"	.062"	2-13/16"	<b>CF150-5CS</b>	<b>CF150-5SS</b>
	1-61/64"	2"	250	350	2.063"	.062"	2-13/16"	<b>CF150-6CS</b>	<b>CF150-6SS</b>
	2-1/64"	2-4/64"	250	350	2.125"	.062"	2-13/16"	<b>CF150-7CS</b>	<b>CF150-7SS</b>
	2-5/64"	2-8/64"	250	350	2.188"	.062"	2-13/16"	<b>CF150-8CS</b>	<b>CF150-8SS</b>
	2-9/64"	2-12/64"	250	350	2.250"	.062"	2-13/16"	<b>CF150-9CS</b>	<b>CF150-9SS</b>
	2-13/64"	2-16/64"	250	350	2.313"	.062"	2-13/16"	<b>CF150-10CS</b>	<b>CF150-10SS</b>
	2-17/64"	2-20/64"	250	350	2.375"	.062"	2-13/16"	<b>CF150-11CS</b>	<b>CF150-11SS</b>
	2-21/64"	2-24/64"	250	350	2.438"	.062"	2-13/16"	<b>CF150-12CS</b>	<b>CF150-12SS</b>
	2"	2-13/64"	2-16/64"	250	300	2.313"	.062"	3-1/8"	<b>CF200-1CS</b>
2-17/64"		2-20/64"	250	300	2.375"	.062"	3-1/8"	<b>CF200-2CS</b>	<b>CF200-2SS</b>
2-21/64"		2-24/64"	250	300	2.438"	.062"	3-1/8"	<b>CF200-3CS</b>	<b>CF200-3SS</b>
2-25/64"		2-28/64"	250	300	2.500"	.062"	3-1/8"	<b>CF200-4CS</b>	<b>CF200-4SS</b>
2-29/64"		2-32/64"	250	300	2.563"	.062"	3-1/8"	<b>CF200-5CS</b>	<b>CF200-5SS</b>
2-33/64"		2-36/64"	250	300	2.625"	.062"	3-1/8"	<b>CF200-6CS</b>	<b>CF200-6SS</b>
2-37/64"		2-40/64"	250	300	2.688"	.062"	3-1/8"	<b>CF200-7CS</b>	<b>CF200-7SS</b>
2-41/64"		2-44/64"	250	300	2.750"	.062"	3-1/8"	<b>CF200-8CS</b>	<b>CF200-8SS</b>
2-45/64"		2-48/64"	250	300	2.813"	.062"	3-1/8"	<b>CF200-9CS</b>	<b>CF200-9SS</b>
2-49/64"		2-52/64"	250	300	2.875"	.062"	3-1/8"	<b>CF200-10CS</b>	<b>CF200-10SS</b>
2-53/64"		2-56/64"	250	300	2.938"	.062"	3-1/8"	<b>CF200-11CS</b>	<b>CF200-11SS</b>
2-57/64"		2-60/64"	250	300	3.000"	.062"	3-1/8"	<b>CF200-12CS</b>	<b>CF200-12SS</b>

\* consult Dixon® at [engineering@dixonvalve.com](mailto:engineering@dixonvalve.com) for pressure rating

<sup>1</sup> based on using crimp cam & groove shanks

<sup>2</sup> based on using King™ crimp nipples

## King Crimp™ Style Ferrules



Only use the crimp style shanks with the crimp style sleeves and ferrules. Due to differences in dimensions and tolerances for safety reasons, do not interchange other manufacturer's products with Dixon® products.



Hose ID	Hose OD		Work. Pressure (PSI)		Ferrule ID	Ferrule Wall Thickness	Ferrule Overall Length	Carbon Steel Part #	304 Stainless Steel Part #
	From	To	cam & groove <sup>1</sup>	King Crimp nipple <sup>2</sup>					
3"	3-13/64"	3-16/64"	150	300	3.313"	.090"	4"	CF300-1CS	CF300-1SS
	3-17/64"	3-20/64"	150	300	3.375"	.090"	4"	CF300-2CS	CF300-2SS
	3-21/64"	3-24/64"	150	300	3.438"	.090"	4"	CF300-3CS	CF300-3SS
	3-25/64"	3-28/64"	150	300	3.500"	.090"	4"	CF300-4CS	CF300-4SS
	3-29/64"	3-32/64"	150	300	3.563"	.090"	4"	CF300-5CS	CF300-5SS
	3-33/64"	3-36/64"	150	300	3.625"	.090"	4"	CF300-6CS	CF300-6SS
	3-37/64"	3-40/64"	150	300	3.688"	.090"	4"	CF300-7CS	CF300-7SS
	3-41/64"	3-44/64"	150	300	3.750"	.090"	4"	CF300-8CS	CF300-8SS
	3-45/64"	3-48/64"	150	300	3.813"	.090"	4"	CF300-9CS	CF300-9SS
	3-49/64"	3-52/64"	150	300	3.875"	.090"	4"	CF300-10CS	CF300-10SS
	3-53/64"	3-56/64"	150	300	3.938"	.090"	4"	CF300-11CS	CF300-11SS
	3-57/64"	3-60/64"	150	300	4.000"	.090"	4"	CF300-12CS	CF300-12SS
	3-61/64"	4"	150	300	4.063"	.090"	4"	CF300-13CS	CF300-13SS
	4-1/64"	4-4/64"	150	300	4.125"	.090"	4"	CF300-14CS	CF300-14SS
	4-5/64"	4-8/64"	150	300	4.188"	.090"	4"	CF300-15CS	CF300-15SS
	4-9/64"	4-12/64"	150	300	4.250"	.090"	4"	CF300-16CS	CF300-16SS
4"	4-13/64"	4-16/64"	150	300	4.313"	.090"	4"	CF400-1CS	CF400-1SS
	4-17/64"	4-20/64"	150	300	4.375"	.090"	4"	CF400-2CS	CF400-2SS
	4-21/64"	4-24/64"	150	300	4.438"	.090"	4"	CF400-3CS	CF400-3SS
	4-25/64"	4-28/64"	150	300	4.500"	.090"	4"	CF400-4CS	CF400-4SS
	4-29/64"	4-32/64"	150	300	4.563"	.090"	4"	CF400-5CS	CF400-5SS
	4-33/64"	4-36/64"	150	300	4.625"	.090"	4"	CF400-6CS	CF400-6SS
	4-37/64"	4-40/64"	150	300	4.688"	.090"	4"	CF400-7CS	CF400-7SS
	4-41/64"	4-44/64"	150	300	4.750"	.090"	4"	CF400-8CS	CF400-8SS
	4-45/64"	4-48/64"	150	300	4.813"	.090"	4"	CF400-9CS	CF400-9SS
	4-49/64"	4-52/64"	150	300	4.875"	.090"	4"	CF400-10CS	CF400-10SS
	4-53/64"	4-56/64"	150	300	4.938"	.090"	4"	CF400-11CS	CF400-11SS
	4-57/64"	4-60/64"	150	300	5.000"	.090"	4"	CF400-12CS	CF400-12SS
	4-61/64"	5"	150	300	5.063"	.090"	4"	CF400-13CS	CF400-13SS
	5-1/64"	5-4/64"	150	300	5.125"	.090"	4"	CF400-14CS	CF400-14SS
	5-5/64"	5-8/64"	150	300	5.188"	.090"	4"	CF400-15CS	CF400-15SS
	5-9/64"	5-12/64"	150	300	5.250"	.090"	4"	CF400-16CS	CF400-16SS
6"	6-21/64"	6-28/64"	*	*	6.500"	.120"	5-7/8"	CF600-1CS	CF600-1SS
	6-29/64"	6-36/64"	*	*	6.625"	.120"	5-7/8"	CF600-2CS	CF600-2SS
	6-37/64"	6-44/64"	*	*	6.750"	.120"	5-7/8"	CF600-3CS	CF600-3SS
	6-45/64"	6-52/64"	*	*	6.875"	.120"	5-7/8"	CF600-4CS	CF600-4SS
	6-53/64"	6-60/64"	*	*	7.000"	.120"	5-7/8"	CF600-5CS	CF600-5SS
	6-61/64"	7-4/64"	*	*	7.125"	.120"	5-7/8"	CF600-6CS	CF600-6SS
	7-5/64"	7-12/64"	*	*	7.250"	.120"	5-7/8"	CF600-7CS	CF600-7SS
	7-13/64"	7-20/64"	*	*	7.375"	.120"	5-7/8"	CF600-8CS	CF600-8SS
	7-21/64"	7-28/64"	*	*	7.500"	.120"	5-7/8"	CF600-9CS	CF600-9SS

\* consult Dixon® at [engineering@dixonvalve.com](mailto:engineering@dixonvalve.com) for pressure rating

<sup>1</sup> based on using crimp cam & groove shanks

<sup>2</sup> based on using King™ crimp nipples

## King Crimp™ Style Combination Nipples

### Threaded End

**Feature:**

- There are two grooves on the crimp style King™ Combination nipples. The second groove is the roll stamp groove which has the part number and 'call Dixon®' stamped on it. This groove is a smooth concentric groove so that the stamp is legible.

Hose ID	Schedule 80 Plated Carbon Steel Part #	316 Stainless Steel Part #
1"	<b>STC10CS</b>	<b>RST10CS</b>
1¼"	<b>STC15CS</b>	<b>RST15CS</b>
1½"	<b>STC20CS</b>	<b>RST20CS</b>
2"	<b>STC25CS</b>	<b>RST25CS</b>
3"	<b>STC35CS</b>	<b>RST35CS</b>
4"	<b>STC40CS</b>	<b>RST40CS</b>
6"	<b>STC60CS</b>	<b>RST60CS</b>

- for 8" options see page 117



### Grooved End

**Feature:**

- There are two grooves on the crimp style King™ Combination nipples. The second groove is the roll stamp groove which has the part number and 'call Dixon®' stamped on it. This groove is a smooth concentric groove so that the stamp is legible.

Hose ID	Schedule 80 Plated Carbon Steel Part #	316 Stainless Steel Part #
1"	<b>STV10CS</b>	<b>RSTV10CS</b>
1½"	<b>STV20CS</b>	<b>RSTV20CS</b>
2"	<b>STV25CS</b>	<b>RSTV25CS</b>
3"	<b>STV35CS</b>	<b>RSTV35CS</b>
4"	<b>STV40CS</b>	<b>RSTV40CS</b>
6"	<b>STV60CS</b>	<b>RSTV60CS</b>



### Beveled End

**Feature:**

- There are two grooves on the crimp style King™ Combination nipples. The second groove is the roll stamp groove which has the part number and 'call Dixon®' stamped on it. This groove is a smooth concentric groove so that the stamp is legible.

Hose ID	Schedule 80 Carbon Steel Part #	316 Stainless Steel Part #
1"	<b>STB10CS</b>	<b>RSTB10CS</b>
1½"	<b>STB20CS</b>	<b>RSTB20CS</b>
2"	<b>STB25CS</b>	<b>RSTB25CS</b>
3"	<b>STB35CS</b>	<b>RSTB35CS</b>
4"	<b>STB40CS</b>	<b>RSTB40CS</b>
6"	<b>STB60CS</b>	<b>RSTB60CS</b>

- For additional information on pipe dimensions please reference [dixonvalve.com](http://dixonvalve.com).



### FJIC

Hose ID	Ambient Working Pressures		Carbon Steel Part #
	Sleeve	Ferrule	
1"	400	400	<b>SFJCT10CS</b>
1½"	300	350	<b>SFJCT20CS</b>
2"	250	300	<b>SFJCT25CS</b>

**Only use the crimp style shanks with the crimp style sleeves and ferrules.**

Due to differences in dimensions and tolerances for safety reasons, do not interchange other manufacturer's products with Dixon® products.



**King Crimp™ Style****150# ASA Fixed (Welded) Flanges**

Only use the crimp style shanks with the crimp style sleeves and ferrules. Due to differences in dimensions and tolerances for safety reasons, do not interchange other manufacturer's products with Dixon® products.

**Features:**

- There are two grooves on the crimp style King™ Combination nipples. The second groove is the roll stamp groove which has the part number and 'call Dixon®' stamped on it. This groove is a smooth concentric groove so that the stamp is legible.



Size	Steel Part #	316 Stainless Steel Part #
1½"	<b>FST20CS</b>	<b>RFST20CS</b>
2"	<b>FST25CS</b>	<b>RFST25CS</b>
3"	<b>FST35CS</b>	<b>RFST35CS</b>
4"	<b>FST40CS</b>	<b>RFST40CS</b>
6"	<b>FST60CS</b>	<b>RFST60CS</b>

- For flange dimensions, diagrams and additional information please reference [dixonvalve.com](http://dixonvalve.com).
- For additional information on pipe dimensions please reference [dixonvalve.com](http://dixonvalve.com).

**Combination Nipple x TTMA Flanges**

carbon steel



aluminum

**Feature:**

- to be used with King Crimp™ sleeves and/or ferrules

Size	Flange Thickness	Carbon Steel Part #	Aluminum Part #
3"	¼"	<b>TTFST35CS</b>	---
3"	⅜"	<b>TTFST35CS-THK</b>	---
4"	5/16"	<b>TTFST40CS</b>	<b>ATTFST40CS</b>
4"	⅜"	<b>TTFST40CS-THK</b>	---

- For flange dimensions, diagrams and additional information please reference [dixonvalve.com](http://dixonvalve.com).
- For additional information on pipe dimensions please reference [dixonvalve.com](http://dixonvalve.com).

**Nipples for Floating Flanges****Feature:**

- to be used with King Crimp™ sleeves and/or ferrules



Size	Plated Carbon Steel Part #	316 Stainless Steel Part #
2"	<b>N25CS</b>	<b>RN25CS</b>
3"	<b>N35CS</b>	<b>RN35CS</b>
4"	<b>N40CS</b>	<b>RN40CS</b>
6"	<b>N60CS</b>	<b>RN60CS</b>

- To be used with LJ/LJR floating flanges on page 688.

**King Crimp™ Style****Short Combination Nipples - Threaded End**

- for use with ferrules below

Size	Schedule 40 Plated Carbon Steel Part #
8"	<b>STC80CS</b>

Hose Coupling  
Systems**Short Combination Nipples - Grooved End**

Size	Schedule 40 Plated Carbon Steel Part #
8"	<b>STV80CS</b>



- For additional information on pipe dimensions please reference dixonvalve.com.

**Short Ferrules**

- consult Dixon® for additional ferrule sizes

Hose ID	Hose OD		Ferrule Wall Thickness	Ferrule ID	Ferrule Overall Length	Carbon Steel Part #
	From	To				
8"	8-29/64"	8-36/64"	.120"	8.625"	4.25"	<b>CFS800-1CS</b>
	8-37/64"	8-44/64"	.120"	8.750"	4.25"	<b>CFS800-2CS</b>
	8-45/64"	8-52/64"	.120"	8.875"	4.25"	<b>CFS800-3CS</b>
	8-53/64"	8-60/64"	.120"	9.000"	4.25"	<b>CFS800-4CS</b>
	8-61/64"	9-4/64"	.120"	9.125"	4.25"	<b>CFS800-5CS</b>
	9-5/64"	9-12/64"	.120"	9.250"	4.25"	<b>CFS800-6CS</b>
	9-13/64"	9-20/64"	.120"	9.375"	4.25"	<b>CFS800-7CS</b>
	9-21/64"	9-28/64"	.120"	9.500"	4.25"	<b>CFS800-8CS</b>

**Large Sleeves**

Hose ID	Sleeve ID	Sleeve Wall Thickness	Sleeve Overall Length	Carbon Steel Part #
8"	8.30"	0.120"	8.75"	<b>S830X875X120CS</b>
	8.38"	0.120"	6.00"	<b>S838X600X120CS</b>
	8.50"	0.120"	6.50"	<b>S850X650X120CS</b>
	8.75"	0.120"	6.00"	<b>S875X600X120CS</b>
	8.98"	0.120"	8.75"	<b>S898X875X120CS</b>
	9.00"	0.090"	4.00"	<b>S900X400X090CS</b>
	9.00"	0.120"	4.00"	<b>S900X400X120CS</b>
	9.00"	0.120"	6.00"	<b>S900X600X120CS</b>
	9.10"	0.120"	4.00"	<b>S910X400X120CS</b>
	9.12"	0.120"	6.00"	<b>S912X600X120CS</b>
	9.15"	0.120"	6.00"	<b>S915X600X120CS</b>
	9.25"	0.120"	4.00"	<b>S925X400X120CS</b>
	9.25"	0.120"	6.00"	<b>S925X600X120CS</b>
	9.50"	0.120"	4.00"	<b>S950X400X120CS</b>
	9.50"	0.120"	6.00"	<b>S950X600X120CS</b>
9.75"	0.120"	6.00"	<b>S975X600X120CS</b>	
10"	10.25"	0.120"	7.50"	<b>S1025X750X120CS</b>
	10.50"	0.120"	7.50"	<b>S1050X750X120CS</b>
	11.00"	0.120"	6.00"	<b>S1100X600X120CS</b>
	11.75"	0.120"	6.00"	<b>S1175X600X120CS</b>



- consult Dixon® for additional sleeve sizes

**King Crimp™ Style****Combination Nipples - Heavy Duty, Threaded End****Application:**

- used in the fast paced transfer of water, chemicals and sand slurry to a hydraulic fracturing site

**Features:**

- Water and petroleum transfer hoses rated from 100 to 300 PSI WP (4:1 SF) have excellent test results with the standard King Crimp™ ferrules *CF400-xxCS*.
- 400 PSI working pressure at 70°F (21°C) when used with heavy duty crimp ferrules (CF400-6CSHD through CF400-16CSHD)
- used with ferrules below



Size	Description	Schedule 80 Steel Part#
4"	male NPT fitting	<b>STC40CSHD</b>

**Ferrules - Heavy Duty**

**Only use the crimp style shanks with the crimp style sleeves and ferrules.** Due to differences in dimensions and tolerances for safety reasons, do not interchange other manufacturer's products with Dixon® products. 

- 400 PSI working pressure with a minimum 4:1 safety factor (*hose burst: hose working pressure*) is only achieved with heavy duty (HD) crimp ferrules, CF400-6CSHD through CF400-16CSHD using heavy duty King Crimp™ stem STC40CSHD.



Hose ID	Hose OD		Ferrule Wall Thickness	Ferrule ID	Ferrule Overall Length	Carbon Steel Part #
	From	To				
4"	4-33/64"	4-36/64"	0.120"	4.625"	4"	<b>CF400-6CSHD</b>
	4-37/64"	4-40/64"	0.120"	4.688"	4"	<b>CF400-7CSHD</b>
	4-41/64"	4-44/64"	0.120"	4.750"	4"	<b>CF400-8CSHD</b>
	4-45/64"	4-48/64"	0.120"	4.813"	4"	<b>CF400-9CSHD</b>
	4-49/64"	4-52/64"	0.120"	4.875"	4"	<b>CF400-10CSHD</b>
	4-53/64"	4-56/64"	0.120"	4.938"	4"	<b>CF400-11CSHD</b>
	4-57/64"	4-60/64"	0.120"	5.000"	4"	<b>CF400-12CSHD</b>
	4-61/64"	5"	0.120"	5.063"	4"	<b>CF400-13CSHD</b>
	5-1/64"	5-4/64"	0.120"	5.125"	4"	<b>CF400-14CSHD</b>
	5-5/64"	5-8/64"	0.120"	5.188"	4"	<b>CF400-15CSHD</b>
	5-9/64"	5-12/64"	0.120"	5.250"	4"	<b>CF400-16CSHD</b>



Cam & Groove Information... 121 - 125	Type E Adapters (cont.).... 142 to 144
	Notched NOS ferrules ..... 144
EZLink™ Armless..... 126 to 127	Type F Adapters..... 145
Type B ..... 126	Dixon® ..... 145
Type C ..... 126	
Type D ..... 126	Dust Caps and Plugs ..... 146 to 149
Type DC..... 127	Type DC..... 146
Replacement parts ..... 127	Dixon® lockable caps ..... 147
Safety clip ..... 127	Type H ..... 147, 148
Bottle opener ..... 127	Type DP..... 149
	Hastelloy® ..... 150 to 151
Vent-Lock™ Safety..... 128 to 130	Type A..... 150
Type A..... 128	Type E ..... 150
Type C ..... 128	Type F..... 150
Type D ..... 129	EZ Boss-Lock™ Type B ..... 151
Type E ..... 129	EZ Boss-Lock™ Type C ..... 151
Type DC, DP and H ..... 129	EZ Boss-Lock™ Type D ..... 151
Accessories ..... 130	
Type A Adapters ..... 131	Reducing Couplers and Adapters. 152 to 156
Dixon® / Boss-Lock™ ..... 131	Dixon® with port ..... 152
with abrasion resistant inserts..... 131	Dixon® ..... 152
Type B Couplers..... 132 to 133	Boss-Lock™ ..... 153
Dixon® ..... 132	EZ Boss-Lock™ ..... 153
Boss-Lock™ ..... 133	Reducing Dixon® with port ..... 153
EZ Boss-Lock™ ..... 133	Dixon® spool adapters ..... 154
Type C Couplers..... 134 to 138	Reducing Type A..... 155
Dixon® ..... 134	Reducing Type B ..... 155
with abrasion resistant inserts..... 134	Reducing Type C ..... 155
Dixon® notched NOS ..... 135	Reducing Type D ..... 156
Boss-Lock™ ..... 135	Reducing Type E ..... 156
Boss-Lock™ with collar ..... 136	Reducing Type F ..... 156
Boss-Lock™ notched ..... 136	
EZ Boss-Lock™ ..... 137	Elbows ..... 157 to 159
EZ Boss-Lock™ phono finish ..... 137	45° ..... 157
EZ Boss-Lock™ swaged with ferrule..... 138	90° ..... 157 - 159
EZ Boss-Lock™ notched..... 138	
Type D Couplers..... 139 to 141	Flanged ..... 160
Dixon® ..... 139	Dixon® ..... 160
Boss-Lock™ ..... 140	EZ Boss-Lock™ ..... 160
EZ Boss-Lock™ ..... 141	
Type E Adapters ..... 142 to 144	Weld End ..... 161 to 162
Dixon® ..... 142	Dixon® couplers ..... 161
Dixon® phono finish ..... 142	EZ Boss-Lock™ couplers ..... 162
Dixon® swaged with ferrule..... 143	Adapters ..... 162
Notched ferrules ..... 143	Boss-Lock Coupler x Tube ..... 163
Notched NOS shank..... 144	
	In-Line Sight Glasses ..... 163
	NSPM and Wye ..... 164

Accessories .....	165 to 173
Handles .....	165 to 166
Gaskets .....	167 to 170
Strainers .....	171
Pull rings.....	171
Abrasion resistant inserts .....	172
Clips.....	171
Jack chain with S-hook.....	172
Velcro® straps .....	172
Lanyards.....	173

## Global ..... 174 to 182

Type A.....	174
Type B .....	175
Type C .....	176
Type D .....	177
Type E .....	178
Type F.....	178
Dust caps and plugs .....	179
Jump size .....	180 to 181
Type DA .....	180
Type AA.....	180
Type DD.....	180
Type A.....	181
Type C.....	181
Type E.....	181
TTMA flange.....	181
Coupler and adapter x ANSI flange .....	182
Accessories .....	182

## NST Adapters ..... 183

Type A.....	183
Type B .....	183
Type D .....	183
Type F.....	183

## Polypropylene ..... 184 to 188

Type A.....	184
Type B .....	184
Type C .....	185
Type D .....	185
Type E .....	186
Type F.....	186
Dust caps and plugs .....	187
90° coupler x female NPT.....	188
90° coupler x hose shank .....	188
90° adapter x female NPT .....	188
90° adapter x male NPT .....	188

## EZLink™ Armless

**Features:**

- automatic couplers push-to-connect providing a reliable connection
- coupler tabs cannot be pushed to disconnect when pressurized to 20 PSI or over
- low profile allows easy connection and disconnection in tight applications
- coupler push tabs can be locked with safety pins and/or zip tie
- maximum working pressure with King Crimp™ ferrules: **250 PSI** (2"), **150 PSI** (3" and 4")
- 4" maximum working pressure with crimp sleeves: **110 PSI**
- 4" maximum working pressure with band clamps: **100 PSI**
- gasket temperature range: **5°F to 180°F (-15°C to 82°C)**
- lifetime warranty on stainless steel tabs



Cam & Groove

## Vent-Lock™ Safety

**Features:**

- safety release cam & groove couplings permit the release of static pressure when disconnecting hose assemblies
- venting system protects operator from being sprayed with hazardous or non-hazardous fluids or solids
- rated to **250 PSI**, recommendation based on the use of mating Dixon™ L-style fittings at ambient temperature **70°F (21°C)** with standard Buna-N seal installed, for use at elevated temperature or other unusual operating conditions, consult Dixon™
  - 1", 1½" and 2" sizes have a maximum working pressure of **250 PSI**
  - 3" maximum working pressure **150 PSI** with King Crimp™ ferrules, crimp sleeves and bands at **125 PSI**
- does not interchange with standard cam & groove products use only with Vent-Lock™ L-style fittings 



## Dixon®

**Features:**

- precision machined to rigid tolerances
- durable stainless steel cam arm pins will not rust or bind, providing greater strength and safety
- recess holds gasket firmly in place - ensures proper placement
- long shank design allows proper banding, thus eliminating the major cause of hose damage





## EZ Boss-Lock™



**Features:**

- no more fumbling with clamps, wire, clips or pins, just close the handles and the locking mechanism is engaged
- extremely easy to open, the release lever is under your thumb when you want to open the fitting, ergonomic
- resistant to accidental disconnection when being dragged; the release lever opens in the direction opposite to the cam arm, so movements that can open the release lever also can close the cam arm
- if the rotating lever is not flush with the handle, it is not properly engaged
- no sliding pins to jam or pop open
- rotating action helps keep the locking device free of debris
- rugged design protects critical parts from impact
- can be supplied with custom shanks, also available with swaged and PF shanks for hard to couple chemical hoses
- assemblies are investment cast stainless steel with plated carbon steel pull rings
- small OD makes it easy to insert into the hose tubes on tank trucks and to use in restricted spaces
- assemblies can be retrofitted onto undamaged stainless steel Boss-Lock™ allowing you to protect your investment in stainless steel Boss-Lock™ couplings while you upgrade
- EZ Boss-Lock™ investment stainless steel cam arms are guaranteed! Should you break one, return it to the nearest warehouse for a free replacement.

## Boss-Lock™



**Features:**

- The cast-in lugs allow safety clips to be attached once the lugs are passed through slots in the special cam lever arms providing a patented safety feature. The clips prevent the coupler from being unlocked until they are removed, providing a *positive locking action*.
- Boss-Lock™ investment stainless steel cam arms are guaranteed! Should you break a Boss-Lock™ investment stainless steel cam arm, return it to the nearest warehouse for a free replacement.
- The pull ring safety clip simplifies the locking action on Boss-Lock™ couplers. No more inserting clips or dangling lanyards, just a twist and it's locked, giving you a low profile positive locking action.



King Crimp™ System Cam and Groove



Dixon® Type C domestic coupler



EZ Boss-Lock™ Type C domestic coupler



Type C global coupler



Dixon® Type E domestic adapter



Type E global adapter

- for a complete listing of King Crimp™ system products, including cam & groove fittings, please reference pages 107 - 118

Crimp Working Pressure Chart

Size	Temperature	Fitting	Clamp	Dixon® Crimp (PSI)	Size	Temperature	Fitting	Clamp	Dixon® Crimp (PSI)
1"	Ambient	100-C/E	sleeve	250	3"	Ambient	300-C/E	sleeve	125
	160°F (71°C)	100-C/E	sleeve	242		160°F (71°C)	300-C/E	sleeve	100
	180°F (82°C)	100-C/E	sleeve	240		180°F (82°C)	300-C/E	sleeve	60
	250°F (121°C)	100-C/E	sleeve	200		250°F (121°C)	300-C/E	sleeve	55
	Ambient	100-C/E	ferrule	250		Ambient	300-C/E	ferrule	150
	160°F (71°C)	100-C/E	ferrule	242		160°F (71°C)	300-C/E	ferrule	125
	180°F (82°C)	100-C/E	ferrule	240		180°F (82°C)	300-C/E	ferrule	100
	250°F (121°C)	100-C/E	ferrule	200		250°F (121°C)	300-C/E	ferrule	75
1½"	Ambient	150-C/E	sleeve	250	4"	Ambient	400-C/E	sleeve	110
	160°F (71°C)	150-C/E	sleeve	200		160°F (71°C)	400-C/E	sleeve	75
	180°F (82°C)	150-C/E	sleeve	100		180°F (82°C)	400-C/E	sleeve	60
	250°F (121°C)	150-C/E	sleeve	75		250°F (121°C)	400-C/E	sleeve	50
	Ambient	150-C/E	ferrule	250		Ambient	400-C/E	ferrule	150
	160°F (71°C)	150-C/E	ferrule	200		160°F (71°C)	400-C/E	ferrule	75
	180°F (82°C)	150-C/E	ferrule	150		180°F (82°C)	400-C/E	ferrule	75
	250°F (121°C)	150-C/E	ferrule	100		250°F (121°C)	400-C/E	ferrule	75
2"	Ambient	200-C/E	sleeve	250	6"	Ambient	600-C/E	sleeve	75
	160°F (71°C)	200-C/E	sleeve	100		160°F (71°C)	600-C/E	sleeve	*
	180°F (82°C)	200-C/E	sleeve	50		180°F (82°C)	600-C/E	sleeve	*
	250°F (121°C)	200-C/E	sleeve	50		250°F (121°C)	600-C/E	sleeve	*
	Ambient	200-C/E	ferrule	250		Ambient	600-C/E	ferrule	75
	160°F (71°C)	200-C/E	ferrule	100		160°F (71°C)	600-C/E	ferrule	*
	180°F (82°C)	200-C/E	ferrule	100		180°F (82°C)	600-C/E	ferrule	*
	250°F (121°C)	200-C/E	ferrule	100		250°F (121°C)	600-C/E	ferrule	*

\* Consult Dixon® for PSI ratings

Ordering System

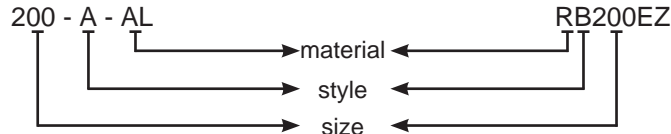

Cam & Groove

Size represents the coupler or adapter and hose or pipe end (i.e. 200 = 2"). If the coupling is a reducing size, the coupler or adapter is the first size (i.e. 4030-C is 4" coupler to 3" hose shank).

Operation of Cam and Groove

1. To make connection, slide the adapter into the coupler and with normal hand pressure, press the cam levers down.
2. Uncoupling is as quick and simple as coupling. Just lift the cam arms and remove the adapter.

Specifications on Dixon Cam and Groove

Specifications:

- Dixon®, Boss-Lock™ and EZ Boss-Lock™ cam & groove couplers and adapters are produced to interchange with all product produced to Commercial Item Description A-A-59326D.
- No standard exists for the ½", 5" and 8" fittings, and generally these sizes do not interchange with other manufacturers.
- Dust caps and dust plugs are **not** to be used in pressure applications for safety and environmental reasons.
- *Designed for use with liquids*, consult Dixon® for specific recommendations.

Pressure Ratings:

Recommendations based on the use of mating Dixon® fittings at ambient temperature **70°F (21°C)** with standard Buna-N seal installed. For use at elevated temperature or other unusual operating conditions, consult Dixon®. Dixon®, Boss-Lock™ and EZ Boss-Lock™ couplers and adapters maximum working pressure are as follows:



Size	½"	¾" thru 2"	2½"	3"	4"	5" and 6"	8"
PSI	150	250	150	125	100	75	50
PSI (working pressure with King Crimp™ ferrule system)	150	250	150	150	150	75	50

Cam and Groove Nominal Take-Up Lengths

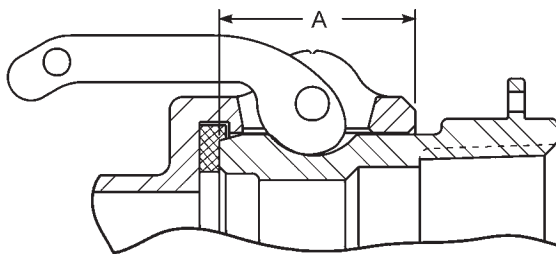

Coupling Size	Dimension A
½"	0.97"
¾"	0.97"
1"	1.20"
1¼"	1.44"
1½"	1.50"
2"	1.81"
2½"	1.82"
3"	1.78"
4"	1.84"
5"	2.00"
6"	2.13"
8"	2.06"
8"	3.22"

## Cam and Groove Configurations

Configurations are representative of the Dixon® line of cam & groove.



**Type A**  
male adapter x female NPT



**Type E**  
male adapter x hose shank

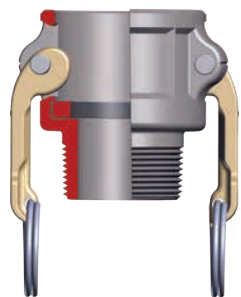

**Type B**  
female coupler x male NPT

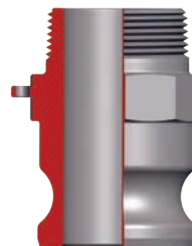

**Type F**  
male adapter x male NPT

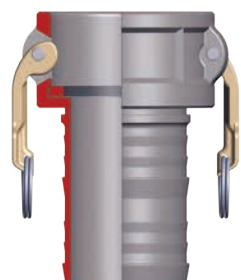

**Type C**  
female coupler x hose shank

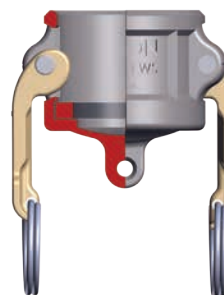

**Type DC <sup>1</sup>**  
dust cap

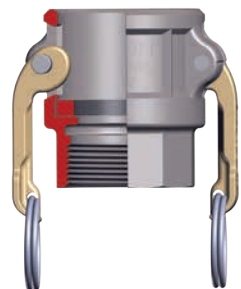

**Type D**  
female coupler x female NPT



**Type DP <sup>1</sup>**  
dust plug



<sup>1</sup> Dust caps and dust plugs are not to be used in pressure applications for safety and environmental reasons.

### **⚠ WARNING**

Under no circumstances should cam and groove couplings be used for compressed air or steam service!

## EZLink™ Armless Cam and Groove

**Applications:**

- transfer and/or unloading of fuels (gasoline or diesel) from tank truck to storage tanks
- transfer of liquids compatible with the available coupling and gasket materials

**Materials:**

- Couplings and dust caps: A356 aluminum, 316 stainless steel
- Coupler tabs and springs: 316 stainless steel
- Gasket: Buna-N

**Features:**

- automatic couplers push-to-connect providing a reliable connection
- low profile allows easy connection and disconnection in tight applications
- coupler push tabs can be locked with safety pins and/or zip tie
- compatible with standard cam and groove adapters
- lifetime warranty on stainless steel tabs



**Specifications:**

- maximum working pressure with King Crimp™ ferrules: **250 PSI** (2"), **150 PSI** (3" and 4")
- maximum working pressure with crimp sleeves: 2" **250 PSI**, 3" **125 PSI**, 4" **110 PSI**
- maximum working pressure with band clamps: 2" **250 PSI**, 3" **125 PSI**, 4" **100 PSI**
- gasket temperature range: **5°F to 180°F (-15°C to 82°C)**

Only use EZLink™ gaskets and tabs for this coupling system. Traditional cam & groove handles and gaskets, or other types of seals are not compatible and will fail. 



### Type B Couplers coupler x male NPT



Size	A356 Aluminum Part #	316 Stainless Steel Part #
1½"	<b>EZL150-B-AL</b> 	<b>EZL150-B-SS</b> 
2"	<b>EZL200-B-AL</b>	<b>EZL200-B-SS</b>
3"	<b>EZL300-B-AL</b>	<b>EZL300-B-SS</b> 
4"	<b>EZL400-B-AL</b>	---



### Type C Couplers - King Crimp™ Hose Shank coupler x hose shank



Size	A356 Aluminum Part #	316 Stainless Steel Part #
1½"	<b>EZL150-C-AL</b> 	<b>EZL150-C-SS</b> 
2"	<b>EZL200-C-AL</b>	<b>EZL200-C-SS</b>
3"	<b>EZL300-C-AL</b>	<b>EZL300-C-SS</b> 
4"	<b>EZL400-C-AL</b>	---

### Type D Couplers coupler x female NPT



Size	A356 Aluminum Part #	316 Stainless Steel Part #
1½"	<b>EZL150-D-AL</b> 	<b>EZL150-D-SS</b> 
2"	<b>EZL200-D-AL</b>	<b>EZL200-D-SS</b>
3"	<b>EZL300-D-AL</b>	<b>EZL300-D-SS</b> 
4"	<b>EZL400-D-AL</b>	---



Type DC Dust Caps

Size	A356 Aluminum Part #	316 Stainless Steel Part #
1½"	<b>EZL150-DC-AL</b> <b>NEW</b>	<b>EZL150-DC-SS</b> <b>NEW</b>
2"	<b>EZL200-DC-AL</b>	<b>EZL200-DC-SS</b>
3"	<b>EZL300-DC-AL</b>	<b>EZL300-DC-SS</b> <b>NEW</b>
4"	<b>EZL400-DC-AL</b>	---



Cam & Groove

Replacement Kits

- kit contains: 2 pins, 2 springs and 2 tabs

Size	Part #
2"	<b>EZL200RPLKIT</b>
3" and 4"	<b>EZL300RPLKIT</b>



Replacement Gaskets

Size	Buna-N Part #	Fluorosilicone <b>NEW</b> Part #	FKM <b>NEW</b> Part #
1½"	<b>EZL150-G-BU</b> <b>NEW</b>	<b>EZL150-G-FV</b>	<b>EZL150-G-VI</b>
2"	<b>EZL200-G-BU</b>	<b>EZL200-G-FV</b>	<b>EZL200-G-VI</b>
3"	<b>EZL300-G-BU</b>	<b>EZL300-G-FV</b>	<b>EZL300-G-VI</b>
4"	<b>EZL400-G-BU</b>	<b>EZL400-G-FV</b>	<b>EZL400-G-VI</b>



Safety Clip

Plated Carbon Steel Part #
<b>EZLCL400</b>

- clip is optional



Bottle Opener

Brass Part #
<b>CAMOPENER</b>



## Vent-Lock™ Safety Cam and Groove Couplings

**Application:**

- transfer of fluids and solids, with a safer disconnection

**Features:**

- safety release cam and groove couplings permit the release of static pressure when disconnecting hose assemblies
- venting system protects operator from being sprayed with hazardous or non-hazardous fluids or solids
- rated to **250 PSI**, recommendation based on the use of mating Dixon® L-style fittings at ambient temperature **70°F (21°C)** with standard Buna-N seal installed, for use at elevated temperature or other unusual operating conditions, consult Dixon™
  - 1", 1½" and 2" sizes have a maximum working pressure of **250 PSI**
  - 3" maximum working pressure **150 PSI** with King Crimp™ ferrules, crimp sleeves and bands at **125 PSI**
  - 4" maximum working pressure **150 PSI** with King Crimp™ ferrules, crimp sleeves and bands at **100 PSI**
- does not interchange with standard cam and groove products use only with Dixon® 
- safety orange cam arms
- consult Dixon® for availability of other materials

**Attachment Options:**

- ferrules, sleeves, bands, and other reliable options

### Type A Adapters adapter x female NPT



Size	316 Stainless Steel Part #	Aluminum Part #
1"	<b>L100-A-SS</b>	---
1½"	<b>L150-A-SS</b>	---
2"	<b>L200-A-SS</b>	---
3"	<b>L300-A-SS</b>	---
4"	---	<b>L400-A-AL</b>

### Type C Couplers coupler x hose shank



Size	316 Stainless Steel Part #
1"	<b>L100-C-SS</b>
1½"	<b>L150-C-SS</b>
2"	<b>L200-C-SS</b>

### EZ Boss-Lock™ Type C Couplers coupler x hose shank



Size	316 Stainless Steel Part #	Aluminum Part #
1"	<b>RLC100EZ</b>	---
1½"	<b>RLC150EZ</b>	---
2"	<b>RLC200EZ<sup>1</sup></b>	---
3"	<b>RLC300EZ<sup>1</sup></b>	---
	---	<b>ALC400EZ<sup>1</sup></b>

<sup>1</sup> has drop shank

Type D Couplers  
coupler x female NPT

Size	316 Stainless Steel Part #
1"	<b>RLD100EZ</b>
1½"	<b>RLD150EZ</b>
2"	<b>RLD200EZ</b>



Type E Adapters  
adapter x hose shank

Size	316 Stainless Steel Part #
1"	<b>L100-E-SS</b>
1½"	<b>L150-E-SS</b>
2"	<b>L200-E-SS</b>
3"	<b>L300-E-SS</b>



Type DC Dust Caps

Size	316 Stainless Steel Part #
1"	<b>L100-DC-SS</b>
1½"	<b>L150-DC-SS</b>
2"	<b>L200-DC-SS</b>



Type DP Dust Plugs

Size	316 Stainless Steel Part #
1"	<b>L100-DP-SS</b>
1½"	<b>L150-DP-SS</b>
2"	<b>L200-DP-SS</b>
3"	<b>L300-DP-SS</b>



EZ Boss-Lock™ Type H Dust Caps

Size	316 Stainless Steel Part #
1"	<b>RLH100EZ</b>
1½"	<b>RLH150EZ</b>
2"	<b>RLH200EZ</b>
3"	<b>RLH300EZ</b>



## Accessories

Cam &amp; Groove

## Dixon® handle assembly

- use only with Dixon® Vent-Lock™ couplers
- includes handle, ring and pin



Size	316 Stainless Steel Part #
1"	<b>L100-HSCRP-SI</b>
1½" - 2"	<b>L200-HSCRP-SI</b>

## EZ Boss-Lock™ handle assembly

- use only with EZ Boss-Lock™ Vent Lock™ couplers
- includes handle, ring and pin

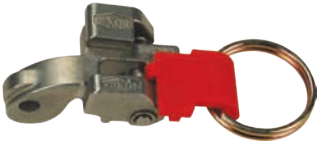

Size	316 Stainless Steel Part #
1"	<b>LRHEZ175</b>
1½" - 2"	<b>LRHEZ152</b>
3"	<b>LRHEZ34</b>

Type A Adapters  
adapter x female NPT

Feature:

- Pressure rating is based on the seal of the mating part. See ratings on page 124.

Size	356T6 Aluminum Part #	Aluminum Hard Coat Part #	Brass Part #
1/2"	<b>50-A-AL</b> <sup>2</sup>	---	<b>50-A-BR</b>
3/4" x 1/2"	<b>7550-A-AL</b> <sup>2</sup>	---	<b>7550-A-BR</b>
3/4"	<b>75-A-AL</b> <sup>2</sup>	---	<b>75-A-BR</b>
1"	<b>100-A-AL</b> <sup>2</sup>	---	<b>100-A-BR</b>
1 1/4"	<b>125-A-AL</b>	---	<b>125-A-BR</b>
1 1/2"	<b>150-A-AL</b>	<b>150-A-ALH</b>	<b>150-A-BR</b>
2"	<b>200-A-AL</b>	<b>200-A-ALH</b>	<b>200-A-BR</b>
2 1/2"	<b>250-A-AL</b>	---	<b>250-A-BR</b>
3"	<b>300-A-AL</b>	<b>300-A-ALH</b>	<b>300-A-BR</b>
4"	<b>400-A-AL</b>	<b>400-A-ALH</b>	<b>400-A-BR</b>
5"	<b>500-A-AL</b>	---	<b>500-A-BR</b>
6"	<b>600-A-AL</b>	<b>600-A-ALH</b>	<b>600-A-BR</b>
8" DIX	<b>800-A-AL</b> <sup>1</sup>	---	---
8" BL	<b>801-A-AL</b> <sup>1</sup>	---	---



356T6 aluminum



aluminum hardcoat



brass



unplated malleable iron



plated malleable iron



316 stainless steel

<sup>1</sup> Dixon® and Boss-Lock™ cam & groove couplings *do not interchange in the 8" size.* 

<sup>2</sup> made from 6061-T6 aluminum

Size	Unplated Malleable Iron Part #	Plated Malleable Iron Part #	316 Stainless Steel Part #
1/2"	---	---	<b>50-A-SS</b>
3/4" x 1/2"	---	---	<b>7550-A-SS</b>
3/4"	---	<b>75-A-PM</b>	<b>75-A-SS</b>
1"	---	<b>100-A-PM</b>	<b>100-A-SS</b>
1 1/4"	---	---	<b>125-A-SS</b>
1 1/2"	<b>150-A-MI</b>	<b>150-A-PM</b>	<b>150-A-SS</b>
2"	<b>200-A-MI</b>	<b>200-A-PM</b>	<b>200-A-SS</b>
2 1/2"	---	---	<b>250-A-SS</b>
3"	<b>300-A-MI</b>	<b>300-A-PM</b>	<b>300-A-SS</b>
4"	<b>400-A-MI</b>	<b>400-A-PM</b>	<b>400-A-SS</b>
5"	<b>500-A-MI</b>	---	<b>500-A-SS</b>
6"	---	<b>600-A-PM</b> <sup>1</sup>	<b>600-A-SS</b>

<sup>1</sup> ductile iron

adapter x female NPT with abrasion resistant inserts

Feature:

- used in extreme abrasion transfer applications such as sand transfer in hydraulic fracturing

Description	UHMW Polyethylene Insert Part #
<b>(400-A-AL)</b> aluminum adapter x female NPT with UHMW insert	<b>400-A-ALINSERT</b>
<b>(400-A-BR)</b> brass adapter x female NPT with UHMW insert	<b>400-A-BRINSERT</b>
<b>(400-A-MI)</b> malleable iron adapter x female NPT with UHMW insert	<b>400-A-MIINSERT</b>
<b>(400-A-SS)</b> stainless steel adapter x female NPT with UHMW insert	<b>400-A-SSINSERT</b>

Replacement inserts are available on page 172.



400-A-ALINSERT

## Dixon® Type B Couplers coupler x male NPT



356T6 aluminum



aluminum hard coat



brass



unplated malleable iron



316 stainless steel

**Features:**

- Couplers are supplied standard with a Buna-N gasket. Other gasket types are available on pages 167 - 170.
- ½" Dixon® coupler has only one cam arm.
- Pull rings are not supplied on ½" - 1" Dixon® couplings.

Size	356T6 Aluminum Part #	Aluminum Hard Coat Part #	Brass Part #
½"	<b>50-B-AL</b>	---	<b>50-B-BR</b>
¾"	<b>75-B-AL</b>	---	<b>75-B-BR</b>
1"	<b>100-B-AL</b>	---	<b>100-B-BR</b>
1¼"	<b>125-B-AL</b>	---	---
1½"	<b>150-B-AL</b>	<b>150-B-ALH</b>	<b>150-B-BR</b>
2"	<b>200-B-AL</b>	<b>200-B-ALH</b>	<b>200-B-BR</b>
2½"	<b>250-B-AL</b>	---	---
3"	<b>300-B-AL</b>	<b>300-B-ALH</b>	<b>300-B-BR</b>
4"	<b>400-B-AL</b>	<b>400-B-ALH</b>	<b>400-B-BR</b>
5"	<b>500-B-AL</b>	---	---
6"	<b>600-B-AL</b>	<b>600-B-ALH</b>	---
8"	<b>800-B-AL</b> <sup>1,2</sup>	---	---

<sup>1</sup> Dixon® and Boss-Lock™ cam & groove couplings *do not interchange in the 8" size*. The 8" Dixon® design has 4 cam arms.

<sup>2</sup> Parts are produced as a welded fabrication.

Size	Unplated Malleable Iron Part #	316 Stainless Steel Part #
½"	---	<b>50-B-SS</b>
¾"	---	<b>75-B-SS</b>
1"	---	<b>100-B-SS</b>
1½"	<b>150-B-MI</b> <sup>1</sup>	<b>150-B-SS</b>
2"	<b>200-B-MI</b>	<b>200-B-SS</b>
2½"	---	<b>250-B-SS</b>
3"	<b>300-B-MI</b> <sup>1</sup>	<b>300-B-SS</b>
4"	<b>400-B-MI</b>	<b>400-B-SS</b>
6"	---	<b>600-B-SS</b>

<sup>1</sup> ductile iron

**Boss-Lock™ Type B Couplers**  
coupler x male NPT

**Features:**

- Couplers are supplied standard with a Buna-N gasket. Other gasket types are available on pages 167 - 170.
- All Boss-Lock™ couplers are supplied with pull-ring safety clips.

Size	356T6 Aluminum Part #	Brass Part #
¾"	---	<b>BB075</b>
1"	<b>AB100</b>	<b>BB100</b>
1¼"	<b>AB125</b>	<b>BB125</b>
1½"	<b>AB150</b>	<b>BB150</b>
2"	<b>AB200</b>	<b>BB200</b>
2½"	<b>AB250</b>	<b>BB250</b>
3"	<b>AB300</b>	<b>BB300</b>
4"	<b>AB400</b>	<b>BB400</b>
6"	<b>AB600</b>	---



356T6 aluminum



brass



plated malleable iron



316 stainless steel

Cam & Groove



Size	Plated Malleable Iron Part #	316 Stainless Steel Part #
¾" x ½"	---	<b>RB050BL</b>
¾"	---	<b>RB075BL</b>
1"	<b>IB100</b>	<b>RB100BL</b>
1¼"	---	<b>RB125BL</b>
1½"	---	<b>RB150BL</b>
2"	<b>IB200</b>	<b>RB200BL</b>
3"	---	<b>RB300BL</b>
4"	---	<b>RB400BL</b>

**EZ Boss-Lock™ Type B Couplers**  
coupler x male NPT

**Feature:**

- Couplers are supplied standard with a Buna-N gasket. Other gasket types are available on pages 167 - 170.

Under no circumstances should the EZ Boss-Lock™ cam arms be used on any fitting not specifically designed for their use. See pages 121 - 125 for further specifications. 

Size	356T6 Aluminum Part #	Brass Part #	316 Stainless Steel Part #
¾" x ½"	---	---	<b>RB050EZ</b>
¾"	---	<b>BB075EZ</b>	<b>RB075EZ</b>
1"	<b>AB100EZ</b>	<b>BB100EZ</b>	<b>RB100EZ</b>
1¼"	---	<b>BB125EZ</b>	<b>RB125EZ</b>
1½"	<b>AB150EZ</b>	<b>BB150EZ</b>	<b>RB150EZ</b>
2"	<b>AB200EZ</b>	<b>BB200EZ</b>	<b>RB200EZ</b>
3"	<b>AB300EZ</b>	<b>BB300EZ</b>	<b>RB300EZ</b>
4"	<b>AB400EZ</b>	<b>BB400EZ</b>	<b>RB400EZ</b>
6"	---	---	<b>RB600EZ</b>



356T6 aluminum



brass



316 stainless steel



356T6 aluminum



aluminum hard coat



brass



unplated ductile iron



316 stainless steel

## Dixon® Type C Couplers coupler x hose shank

### Features:

- Couplers are supplied standard with a Buna-N gasket. Other gasket types are available on pages 167 - 170.
- ½" Dixon coupler has only one cam arm.
- Pull rings are not supplied on ½" - 1" Dixon® couplings.

Hose ID	356T6 Aluminum Part #	Aluminum Hard Coat Part #	Brass Part #
½"	<b>50-C-AL</b>	---	<b>50-C-BR</b>
¾"	<b>75-C-AL</b>	---	<b>75-C-BR</b>
1"	<b>100-C-AL</b>	---	<b>100-C-BR</b>
1¼"	<b>125-C-AL</b>	---	<b>125-C-BR</b>
1½"	<b>150-C-AL</b>	<b>150-C-ALH</b>	<b>150-C-BR</b>
2"	<b>200-C-AL</b>	<b>200-C-ALH</b>	<b>200-C-BR</b>
2½"	<b>250-C-AL</b>	---	<b>250-C-BR</b>
3"	<b>300-C-AL</b>	<b>300-C-ALH</b>	<b>300-C-BR</b>
4"	<b>400-C-AL</b>	<b>400-C-ALH</b>	<b>400-C-BR</b>
5"	<b>500-C-AL</b>	---	---
6"	<b>600-C-AL</b>	<b>600-C-ALH</b>	<b>600-C-BR</b>
8"	<b>800-C-AL</b> <sup>1</sup>	---	---

Hose ID	Unplated Ductile Iron Part #	316 Stainless Steel Part #
½"	---	<b>50-C-SS</b>
¾"	---	<b>75-C-SS</b>
1"	---	<b>100-C-SS</b>
1¼"	---	<b>125-C-SS</b>
1½"	<b>150-C-MI</b>	<b>150-C-SS</b>
2"	<b>200-C-MI</b> <sup>2</sup>	<b>200-C-SS</b>
2½"	---	<b>250-C-SS</b>
3"	<b>300-C-MI</b> <sup>2,3</sup>	<b>300-C-SS</b>
4"	<b>400-C-MI</b> <sup>2,3</sup>	<b>400-C-SS</b>
5"	---	<b>500-C-SS</b>
6"	<b>600-C-MI</b> <sup>2,3</sup>	<b>600-C-SS</b>

<sup>1</sup> Dixon® and Boss-Lock™ cam & groove couplings *do not interchange in the 8" size*. The 8" Dixon® design has 4 cam arms.

<sup>2</sup> Suitable for use with King Crimp™ sleeves and ferrules, see pages 111 - 114

<sup>3</sup> ductile iron

### Only use the crimp style shanks with the crimp style sleeves and ferrules.

Due to differences in dimensions and tolerances for safety reasons, do not interchange other manufacturer's products with Dixon® products.



**NEW**



400-C-MIINSERT

### coupler x hose shank with abrasion resistant inserts

#### Feature:

- used in extreme abrasion transfer applications such as sand transfer in hydraulic fracturing

Description	UHMW Polyethylene Part #
(400-C-AL) aluminum coupler x hose shank with UHMW insert	<b>400-C-ALINSERT</b>
(400-A-MI) malleable iron coupler x hose shank with UHMW insert	<b>400-C-MIINSERT</b>

Replacement inserts are available on page 172.



Dixon® Type C Couplers with Notched NOS Shank  
coupler x NOS shank

Features:

- system allows you to better manage your inventories, you can stock one stem and two ferrules, and cover the same hose range with less inventory, *you must purchase a fitting and the matching ferrule to create an assembly*
- for hose outside diameters of 2-4/64" and below, *the couplings are crimp only* 
- for hose outside diameters of 2-5/64" and above, the couplings can be crimped or swaged
- for use with notched ferrules on page 143
- see page 195 for male NPT notched NOS fittings

Size	316 Stainless Steel Part #
1½"	<b>150CNOSSS</b> <sup>1</sup>
2"	<b>200CNOSSS</b>
3"	<b>300CNOSSS</b>

<sup>1</sup> part will be discontinued as stock is depleted

**Only use the NOS shank with the NOS ferrules.**

Due to differences in dimensions and tolerances for safety reasons, do not use other manufacturer's stems or ferrules with Dixon® products. 



Cam & Groove

Boss-Lock™ Type C Couplers  
coupler x hose shank

Features:

- Couplers are supplied standard with a Buna-N gasket. Other gasket types are available on pages 167 - 170
- All Boss-Lock™ couplers are supplied with pull-ring safety clips.

Size	356T6 Aluminum	Brass
	Part #	Part #
¾"	<b>AC075</b>	<b>BC075</b>
1"	<b>AC100</b>	<b>BC100</b>
1¼"	<b>AC125</b>	<b>BC125</b>
1½"	<b>AC150</b>	<b>BC150</b>
2"	<b>AC200</b>	<b>BC200</b>
2½"	<b>AC250</b>	<b>BC250</b>
3"	<b>AC300</b>	<b>BC300</b>
4"	<b>AC400</b>	<b>BC400</b>
6"	<b>AC600</b>	<b>BC600</b>
8"	<b>AC800</b> <sup>1</sup>	---



356T6 aluminum



brass

Size	Plated Malleable Iron	316 Stainless Steel
	Part #	Part #
¾" x ½"	---	<b>RC050BL</b>
¾"	<b>IC075</b>	<b>RC075BL</b>
1"	<b>IC100</b>	<b>RC100BL</b>
1¼"	---	<b>RC125BL</b>
1½"	<b>IC150</b>	<b>RC150BLNO</b>
2"	<b>IC200</b>	<b>RC200BLNO</b>
3"	<b>IC300</b>	<b>RC300BL</b>
4"	<b>IC400</b> <sup>2</sup>	<b>RC400BLNO</b>
6"	<b>IC600</b> <sup>2</sup>	---



plated malleable iron



316 stainless steel

<sup>1</sup> Dixon® and Boss-Lock™ cam & groove couplings *do not interchange in the 8" size.* 

<sup>2</sup> ductile iron

## EZ Boss-Lock™ Type C Couplers with Collared Hose Shank

## coupler x collared hose shank

Cam &amp; Groove

**Features:**

- design provides greater resistance to end pull than conventional band clamps and are designed for use with Strap-Grip Saddles
  - saddles are sold in pairs and designed for use with 3/4" or 5/8" wide band clamps
  - bands must be purchased separately
- band clamps should first be applied to the OD to seal the hose, then Strap-Grip saddles should be banded over the initial clamp to anchor the fitting in the hose

Size	316 Stainless Steel Part #
1"	<b>RC100CEZ</b>
1½"	<b>RC150CEZ</b>
2"	<b>RC200CEZ</b>

## Boss-Lock™ Type C Couplers with Notched Shank

## coupler x hose shank

**Features:**

- coupling can be removed from a damaged hose by cutting away the ferrule, without necessarily damaging the fitting, *after inspection of the fitting to determine its suitability for reuse*, it can be reinstalled into another hose by using a *new ferrule*
- system allows you to better manage your inventories, you can stock one coupling and two ferrules, and cover the same hose range with less inventory, *you must purchase a fitting and the matching ferrule to create an assembly*
- for use with notched ferrules on page 144

Dixon® stems and ferrules are specifically designed to be used together as a coupling system. Due to differences in dimensions and tolerances for safety reasons, do not use other manufacturer's stems or ferrules with Dixon® products.

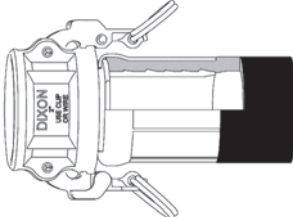

crimped assembly

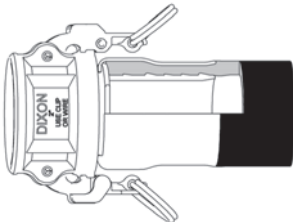

swaged assembly

Size	316 Stainless Steel Part #
1½"	<b>RC150BLNO</b>
2"	<b>RC200BLNO</b>
3"	<b>RC300BLNO</b>
4"	<b>RC400BLNO</b>

Contact Dixon® for swage and crimp recommendations.

EZ Boss-Lock™ Type C Couplers

coupler x hose shank

**Feature:**

- Couplers are supplied standard with a Buna-N gasket. Other gasket types are available on pages 167 - 170

Size	356T6 Aluminum Part #	Brass Part #	316 Stainless Steel Part #
¾" x ½"	---	---	<b>RC050EZ</b>
¾"	<b>AC075EZ</b>	<b>BC075EZ</b>	<b>RC075EZ</b>
1"	<b>AC100EZ</b>	<b>BC100EZ</b>	<b>RC100EZCR</b>
1¼"	---	<b>BC125EZ</b>	<b>RC125EZCR</b>
1½"	<b>AC150EZ</b>	<b>BC150EZ</b>	<b>RC150EZNO</b>
2"	<b>AC200EZ</b>	<b>BC200EZ</b>	<b>RC200EZNO</b>
2½"	<b>AC250EZ</b>	---	---
3"	<b>AC300EZ</b>	<b>BC300EZ</b>	<b>RC300EZCR</b>
4"	<b>AC400EZ</b>	<b>BC400EZ</b>	<b>RC400EZCR</b>
6"	<b>AC600EZ</b>	---	<b>RC600EZCR</b>
8"	<b>AC800EZ<sup>1</sup></b>	---	---

<sup>1</sup> Dixon® and Boss-Lock™ cam & groove couplings *do not interchange in the 8" size. Under no circumstances should the EZ Boss-Lock™ cam arms be used on any fitting not specifically designed for their use.*  
See pages 121 - 125 for further specifications.



356T6 aluminum



brass



316 stainless steel

Cam & Groove



EZ Boss-Lock™ Type C Couplers with Phono Finish Shank

**Applications:**

- The shank design on these fittings was developed specifically for chemical transport hoses having Crosslinked Polyethylene (XLPE) or Ultra High Molecular Weight Polyethylene (UHMW) tubes, where shank retention can be a problem when using conventional band clamps.

**Features:**

- in testing tank transport hoses from a wide variety of manufacturers, the Boss-Lock™ PF fitting showed significant improvement in hose coupling retention over the conventional cam & groove shank design
- for best results we recommend the use of ¾" wide band clamps found on page 276
- other sizes available, consult Dixon® for pricing and availability



Size	316 Stainless Steel Part #	Optional Qty
2"	<b>RC200EZPF</b>	10
3"	<b>RC300EZPF</b>	5

## EZ Boss-Lock™ Type C Couplers with Swaged Ferrule

**Application:**

- Developed specifically for chemical transport hoses having Crosslinked Polyethylene (XLPE) or Ultra High Molecular Weight Polyethylene (UHMW) tubes. Swaged Boss-Lock™ provides you with a permanently attached cam and groove fitting when superior coupling retention is required.

**Features:**

- in testing tank transport hoses from a wide variety of manufacturers, the swaged Boss-Lock™ fitting proved itself to be the clear winner in overall performance
- available on special order, other sizes or hose OD's, consult Dixon® for pricing and availability
- *special equipment required for installation*, consult Dixon® for pricing and availability or refer to page 85 for more information

Size	Hose OD		316 Stainless Steel Part #
	from	to	
¾"	1-6/64"	1-22/64"	<b>RC075EZ-70</b>
1"	1-29/64"	1-35/64"	<b>RC100EZ-20</b>
1"	1-36/64"	1-44/64"	<b>RC100EZ-70</b>

EZ Boss-Lock™ Type C Couplers with Notched Hose Shank  
coupler x hose shank**Features:**

- coupling can be removed from a damaged hose by cutting away the ferrule, without necessarily damaging the fitting, *after inspection of the fitting to determine its suitability for reuse*, it can be reinstalled into another hose by using a *new ferrule*
- system allows you to better manage your inventories, you can stock one coupling and two ferrules, and cover the same hose range with less inventory, *you must purchase a fitting and the matching ferrule to create an assembly*
- for use with notched ferrules on page 143



Size	316 Stainless Steel Part #
1½"	<b>RC150EZNO</b>
2"	<b>RC200EZNO</b>
3"	<b>RC300EZNO</b>
4"	<b>RC400EZNO</b>

Dixon® stems and ferrules are specifically designed to be used together as a coupling system. Due to differences in dimensions and tolerances for safety reasons, do not use other manufacturer's stems or ferrules with Dixon® products.



Dixon® Type D Couplers  
coupler x female NPT

Features:

- Couplers are supplied standard with a Buna-N gasket. Other gasket types are available on pages 167 - 170.
- ½" Dixon® coupler has only one cam arm.
- Pull rings are not supplied on ½" - 1" Dixon® couplings.

Size	356T6 Aluminum Part #	Aluminum Hard Coat Part #	Brass Part #
½"	<b>50-D-AL</b>	---	<b>50-D-BR</b>
¾"	<b>75-D-AL</b>	---	<b>75-D-BR</b>
1"	<b>100-D-AL</b>	---	<b>100-D-BR</b>
1¼"	<b>125-D-AL</b>	---	<b>125-D-BR</b>
1½"	<b>150-D-AL</b>	<b>150-D-ALH</b>	<b>150-D-BR</b>
2"	<b>200-D-AL</b>	<b>200-D-ALH</b>	<b>200-D-BR</b>
2½"	<b>250-D-AL</b>	---	<b>250-D-BR</b>
3"	<b>300-D-AL</b>	<b>300-D-ALH</b>	<b>300-D-BR</b>
4"	<b>400-D-AL</b>	<b>400-D-ALH</b>	<b>400-D-BR</b>
5"	<b>500-D-AL</b>	---	<b>500-D-BR</b>
6"	<b>600-D-AL</b>	<b>600-D-ALH</b>	<b>600-D-BR</b>
8"	<b>800-D-AL</b> <sup>1,2</sup>	---	---

<sup>1</sup> Dixon® and Boss-Lock™ cam & groove couplings *do not interchange in the 8" size.*

<sup>2</sup> The 8" Dixon® design has 4 cam arms.



356T6 aluminum



aluminum hard coat



brass



unplated malleable iron



316 stainless steel

Size	Unplated Malleable Iron Part #	316 Stainless Steel Part #
½"	---	<b>50-D-SS</b>
¾"	---	<b>75-D-SS</b>
1"	---	<b>100-D-SS</b>
1¼"	---	<b>125-D-SS</b>
1½"	<b>150-D-MI</b>	<b>150-D-SS</b>
2"	<b>200-D-MI</b>	<b>200-D-SS</b>
2½"	---	<b>250-D-SS</b>
3"	<b>300-D-MI</b>	<b>300-D-SS</b>
4"	<b>400-D-MI</b> <sup>1</sup>	<b>400-D-SS</b>
5"	<b>500-D-MI</b>	<b>500-D-SS</b>
6"	---	<b>600-D-SS</b>

<sup>1</sup> ductile iron

## Boss-Lock™ Type D Couplers coupler x female NPT



356T6 aluminum



brass



plated malleable iron



316 stainless steel

**Features:**

- Couplers are supplied standard with a Buna-N gasket. Other gasket types are available on pages 167 -170.
- All Boss-Lock™ couplers are supplied with pull-ring safety clips.

Size	356T6 Aluminum	Brass
	Part #	Part #
3/4" x 1/2"	<b>AD050</b>	<b>BD050</b>
3/4"	<b>AD075</b>	<b>BD075</b>
1"	<b>AD100</b>	<b>BD100</b>
1 1/4"	<b>AD125</b>	<b>BD125</b>
1 1/2"	<b>AD150</b>	<b>BD150</b>
2"	<b>AD200</b>	<b>BD200</b>
2 1/2"	<b>AD250</b>	<b>BD250</b>
3"	<b>AD300</b>	<b>BD300</b>
4"	<b>AD400</b>	<b>BD400</b>
5"	<b>AD500</b>	---
6"	<b>AD600</b>	<b>BD600</b>
8"	<b>AD800</b> <sup>1</sup>	---

Size	Plated Malleable Iron	316 Stainless Steel
	Part #	Part #
3/4" x 1/2"	---	<b>RD050BL</b>
3/4"	<b>ID075</b>	<b>RD075BL</b>
1"	<b>ID100</b>	<b>RD100BL</b>
1 1/4"	---	<b>RD125BL</b>
1 1/2"	<b>ID150</b>	<b>RD150BL</b>
2"	<b>ID200</b>	<b>RD200BL</b>
3"	<b>ID300</b>	<b>RD300BL</b>
4"	<b>ID400</b>	<b>RD400BL</b>
6"	<b>ID600</b> <sup>2</sup>	---

- <sup>1</sup> Dixon® and Boss-Lock™ cam & groove couplings *do not interchange in the 8" size.*
- <sup>2</sup> ductile iron



EZ Boss-Lock™ Type D Couplers  
coupler x female NPT

**Feature:**

- Couplers are supplied standard with a Buna-N gasket. Other gasket types are available on pages 167 - 170.

Under no circumstances should the EZ Boss-Lock™ cam arms be used on any fitting not specifically designed for their use. See page 122 for further specifications



356T6 aluminum



brass



316 stainless steel



heavy duty 316 stainless steel

Size	356T6 Aluminum Part #	Brass Part #
3/4" x 1/2"	---	---
3/4"	<b>AD075EZ</b>	<b>BD075EZ</b>
1"	<b>AD100EZ</b>	<b>BD100EZ</b>
1 1/4"	---	<b>BD125EZ</b>
1 1/2"	<b>AD150EZ</b>	<b>BD150EZ</b>
2"	<b>AD200EZ</b>	<b>BD200EZ</b>
2 1/2"	<b>AD250EZ</b>	<b>BD250EZ</b>
3"	<b>AD300EZ</b>	<b>BD300EZ</b>
4"	<b>AD400EZ</b>	<b>BD400EZ</b>
5"	<b>AD500EZ</b>	---
6"	<b>AD600EZ</b>	---
8"	<b>AD800EZ</b> <sup>1</sup>	---

Size	316 Stainless Steel Part #	Heavy Duty 316 Stainless Steel Part #
3/4" x 1/2"	<b>RD050EZ</b>	---
3/4"	<b>RD075EZ</b>	---
1"	<b>RD100EZ</b>	---
1 1/4"	<b>RD125EZ</b>	---
1 1/2"	<b>RD150EZ</b>	---
2"	<b>RD200EZ</b>	---
2 1/2"	<b>RD250EZ</b>	---
3"	<b>RD300EZ</b>	<b>RD300EZHD</b> <sup>2</sup>
4"	<b>RD400EZ</b>	<b>RD400EZHD</b> <sup>3</sup>
5"	---	---
6"	<b>RD600EZ</b>	---

<sup>1</sup> Dixon® and Boss-Lock™ cam & groove couplings *do not interchange in the 8" size.*

<sup>2</sup> pressure rating of **400 PSI**

<sup>3</sup> pressure rating of **300 PSI**



Type E Adapters  
adapter x hose shank

Cam & Groove



356T6 aluminum



aluminum hard coat

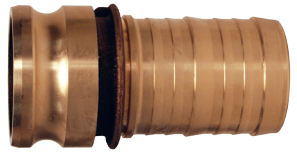

brass



unplated malleable iron



plated malleable iron



316 stainless steel

Feature:

- Pressure rating is based on the seal of the mating part. See ratings on page 124.

Size	356T6 Aluminum Part #	Aluminum Hard Coat Part #	Brass Part #
1/2"	<b>50-E-AL</b>	---	<b>50-E-BR</b>
3/4" x 1/2"	<b>7550-E-AL</b>	---	---
3/4"	<b>75-E-AL</b>	---	<b>75-E-BR</b>
1"	<b>100-E-AL</b>	---	<b>100-E-BR</b>
1 1/4"	<b>125-E-AL</b>	---	<b>125-E-BR</b>
1 1/2"	<b>150-E-AL</b>	<b>150-E-ALH</b>	<b>150-E-BR</b>
2"	<b>200-E-AL</b>	<b>200-E-ALH</b>	<b>200-E-BR</b>
2 1/2"	<b>250-E-AL</b>	---	<b>250-E-BR</b>
3"	<b>300-E-AL</b>	<b>300-E-ALH</b>	<b>300-E-BR</b>
4"	<b>400-E-AL</b>	<b>400-E-ALH</b>	<b>400-E-BR</b>
5"	<b>500-E-AL</b>	---	---
6"	<b>600-E-AL</b>	<b>600-E-ALH</b>	<b>600-E-BR</b>
8" DIX	<b>800-E-AL</b> <sup>1</sup>	---	---
8" BL	<b>801-E-AL</b> <sup>1</sup>	---	---

<sup>1</sup> Dixon® and Boss-Lock™ cam & groove couplings *do not interchange in the 8" size.*



Size	Unplated Malleable Iron Part #	Plated Malleable Iron Part #	316 Stainless Steel Part #
1/2"	---	---	<b>50-E-SS</b>
3/4" x 1/2"	---	---	<b>7550-E-SS</b>
3/4"	---	<b>75-E-PM</b>	<b>75-E-SS</b>
1"	---	<b>100-E-PM</b>	<b>100-E-SS</b>
1 1/4"	---	<b>125-E-PM</b>	<b>125-E-SS</b>
1 1/2"	<b>150-E-MI</b>	<b>150-E-PM</b>	<b>150-E-SS</b>
2"	<b>200-E-MI</b> <sup>2</sup>	<b>200-E-PM</b>	<b>200-E-SS</b>
2 1/2"	---	---	<b>250-E-SS</b>
3"	<b>300-E-MI</b> <sup>1,2</sup>	<b>300-E-PM</b> <sup>1,2</sup>	<b>300-E-SS</b>
4"	<b>400-E-MI</b> <sup>1,2</sup>	<b>400-E-PM</b> <sup>1,2</sup>	<b>400-E-SS</b>
5"	---	---	<b>500-E-SS</b>
6"	<b>600-E-MI</b> <sup>1,2</sup>	<b>600-E-PM</b> <sup>1,2</sup>	<b>600-E-SS</b>

<sup>1</sup> suitable for King Crimp™ sleeves and ferrules, see pages 111 - 114

<sup>2</sup> ductile iron

Type E Adapter with Phono Finish Shank

Applications:

- Shank design developed specifically for chemical transport hoses having Crosslinked Polyethylene (XLPE) or Ultra High Molecular Weight Polyethylene (UHMW) tubes, where shank retention can be a problem when using conventional band clamps.

Features:

- When testing tank transport hoses from a wide variety of manufacturers, the Boss-Lock™ PF fitting showed significant improvement in hose coupling retention over the conventional cam and groove shank design.
- for best results Dixon® recommends the use of 3/4" wide band clamps found on page 276
- other sizes available, consult Dixon® for pricing and availability



Size	316 Stainless Steel Part #	Optional Qty
2"	<b>RE200PF</b>	10



## Type E Adapters with Swaged Ferrule

**Applications:**

- Developed specifically for chemical transport hoses having Crosslinked Polyethylene (XLPE) or Ultra High Molecular Weight Polyethylene (UHMW) tubes.

**Features:**

- provides a permanently attached cam and groove fitting when superior coupling retention is required
- testing tank transport hoses from a wide variety of manufacturers proved the swaged Boss-Lock™ fitting to be the leader in overall performance
- other sizes or hose OD's (available on special order), consult Dixon® for pricing and availability
- *special equipment required for installation*, consult Dixon® for pricing and availability or refer to page 85 for more information



Cam & Groove

Size	Hose OD		316 Stainless Steel Part #
	from	to	
¾"	1-6/64"	1-22/64"	<b>RE075-1370</b>
1"	1-29/64"	1-35/64"	<b>RE100-1620</b>
1"	1-36/64"	1-44/64"	<b>RE100-1770</b>

## Type E Adapters with Notched Shank adapter x hose shank

**Features:**

- can be removed from a damaged hose by cutting away the ferrule without necessarily damaging the fitting, *after inspection of the fitting to determine its suitability for reuse*, it can be reinstalled into another hose by using a *new ferrule*
- system allows you to better manage your inventory, stock one coupling and two ferrules and cover the same hose range with less inventory, *you must purchase a fitting and the matching ferrule to create an assembly*
- for use with notched ferrules below

Dixon® stems and ferrules are specifically designed to be used together as a coupling system. Due to differences in dimensions and tolerances for safety reasons, do not use other manufacturer's stems or ferrules with Dixon® products.

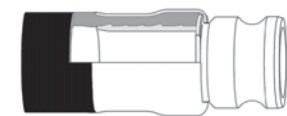

swaged assembly

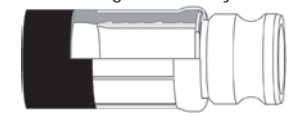

crimped assembly

Size	316 Stainless Steel Part #
1½"	<b>RE150NO</b>
2"	<b>RE200NO</b>
3"	<b>RE300NO</b>
4"	<b>RE400NO</b>

## Notched Ferrules

- reference notched shanks and adapters above
- Dixon® stems and ferrules are specifically designed to be used together as a coupling system. Due to differences in dimensions and tolerances for safety reasons, do not use other manufacturer's stems or ferrules with Holedall™ products.



Size	Hose OD		304 Stainless Steel Part #
	From	To	
1½"	1-60/64"	2-12/64"	<b>GAS2334NO</b>
1½"	2-4/64"	2-22/64"	<b>GAS2370NO</b>
2"	2-30/64"	2-44/64"	<b>GAS2709NO</b>
2"	2-42/64"	2-54/64"	<b>GAS2885NO</b>
2½"	2-54/64"	3"	<b>GAS3012NO</b>
2½"	3-1/64"	3-13/64"	<b>GAS3260NO</b>
3"	3-30/64"	3-46/64"	<b>GAS3760NO</b>
3"	3-47/64"	3-54/64"	<b>GAS3885NO</b>
4"	4-40/64"	4-47/64"	<b>GAS5010NO</b>



## Type E Adapters with Notched NOS shank adapter x shank

Cam &amp; Groove



### Features:

- system allows you to better manage your inventories, you can stock one stem and two ferrules, and cover the same hose range with less inventory, *you must purchase a fitting and the matching ferrule to create an assembly*
- for hose outside diameters of 2-4/64" and below, *the couplings are crimp only* 
- for hose outside diameters of 2-5/64" and above, the couplings can be crimped or swaged
- for use with notched ferrules on page 143
- see page 195 for male NPT notched NOS fittings

Size	316 Stainless Steel Part #
1½"	<b>150ENOSSS<sup>1</sup></b>
2"	<b>200ENOSSS</b>
3"	<b>300ENOSSS</b>

<sup>1</sup> part will be discontinued as stock is depleted

### Only use the NOS shank with the NOS ferrules.

Due to differences in dimensions and tolerances for safety reasons, do not use other manufacturer's stems or ferrules with Dixon® products. 

## Notched NOS Ferrules

- reference notched shanks on page 195 and adapters above



Size	Hose OD		304 Stainless Steel Part #
	From	To	
1½"	1-60/64"	2-12/64"	<b>GAS2334NOS</b>
1½"	2-4/64"	2-22/64"	<b>GAS2370NOS</b>
2"	2-30/64"	2-44/64"	<b>GAS2709NOS</b>
2"	2-42/64"	2-54/64"	<b>GAS2885NOS</b>
3"	3-30/64"	3-46/64"	<b>GAS3760NOS</b>
3"	3-47/64"	3-54/64"	<b>GAS3885NOS</b>
4"	4-40/64"	4-47/64"	<b>GAS5010NOS</b>

Type F Adapters x NPT  
adapter x male NPT

• Pressure rating is based on the seal of the mating part. See ratings on page 124. 

Size	356T6 Aluminum Part #	Aluminum Hard Coat Part #	Brass Part #
1/2"	<b>50-F-AL</b>	---	<b>50-F-BR</b>
3/4" x 1/2"	<b>7550-F-AL</b>	---	<b>7550-F-BR</b>
3/4"	<b>75-F-AL</b>	---	<b>75-F-BR</b>
1"	<b>100-F-AL</b>	---	<b>100-F-BR</b>
1 1/4"	<b>125-F-AL</b>	---	<b>125-F-BR</b>
1 1/2"	<b>150-F-AL</b>	<b>150-F-ALH</b>	<b>150-F-BR</b>
2"	<b>200-F-AL</b>	<b>200-F-ALH</b>	<b>200-F-BR</b>
2 1/2"	<b>250-F-AL</b>	---	<b>250-F-BR</b>
3"	<b>300-F-AL</b>	<b>300-F-ALH</b>	<b>300-F-BR</b>
4"	<b>400-F-AL</b>	<b>400-F-ALH</b>	<b>400-F-BR</b>
5"	<b>500-F-AL</b>	---	---
6"	<b>600-F-AL</b>	<b>600-F-ALH</b>	<b>600-F-BR</b>
8" DIX	<b>800-F-AL</b> <sup>1</sup>	---	---
8" BL	<b>801-F-AL</b> <sup>1</sup>	---	---



356T6 aluminum



aluminum hard coat



brass



unplated malleable iron



plated malleable iron



316 stainless

<sup>1</sup> Dixon® and Boss-Lock™ cam & groove couplings do not interchange in the 8" size. 

Size	Unplated Malleable Iron Part #	Plated Malleable Iron Part #	316 Stainless Steel Part #
1/2"	---	---	<b>50-F-SS</b>
3/4" x 1/2"	---	---	<b>7550-F-SS</b>
3/4"	---	<b>75-F-PM</b>	<b>75-F-SS</b>
1"	---	<b>100-F-PM</b>	<b>100-F-SS</b>
1 1/4"	---	---	<b>125-F-SS</b>
1 1/2"	<b>150-F-MI</b>	<b>150-F-PM</b>	<b>150-F-SS</b>
2"	<b>200-F-MI</b>	<b>200-F-PM</b>	<b>200-F-SS</b>
2 1/2"	---	---	<b>250-F-SS</b>
3"	<b>300-F-MI</b>	<b>300-F-PM</b>	<b>300-F-SS</b>
4"	<b>400-F-MI</b>	<b>400-F-PM</b>	<b>400-F-SS</b>
6"	---	<b>600-F-PM</b>	<b>600-F-SS</b>

Dixon® Type DC Dust Caps

Cam & Groove



356T6 aluminum



aluminum hard coat



brass



unplated malleable iron



316 stainless steel

Features:

- Buna-N gasket supplied standard, other gaskets available on pages 167 - 170.
- ½" Dixon® has only one cam arm.
- Pull rings are not supplied on ½" - 1" Dixon® couplings.

Size	356T6 Aluminum Part #	Aluminum Hard Coat Part #	Brass Part #
½"	<b>50-DC-AL</b>	---	<b>50-DC-BR</b>
¾"	<b>75-DC-AL</b>	---	<b>75-DC-BR</b>
1"	<b>100-DC-AL</b>	---	<b>100-DC-BR</b>
1½"	<b>150-DC-AL</b>	<b>150-DC-ALH</b>	<b>150-DC-BR</b>
2"	<b>200-DC-AL</b>	<b>200-DC-ALH</b>	<b>200-DC-BR</b>
2½"	<b>250-DC-AL</b>	---	---
3"	<b>300-DC-AL</b>	<b>300-DC-ALH</b>	<b>300-DC-BR</b>
4"	<b>400-DC-AL</b>	<b>400-DC-ALH</b>	<b>400-DC-BR</b>
5"	<b>500-DC-AL</b>	---	<b>500-DC-BR</b>
6"	<b>600-DC-AL</b>	<b>600-DC-ALH</b>	---
8"	<b>800-DC-AL</b> <sup>1,2</sup>	---	---

<sup>1</sup> Dixon® and Boss-Lock™ cam & groove couplings *do not interchange* in the 8" size.

<sup>2</sup> The 8" Dixon® dust cap has 2 cam arms.



Size	Unplated Malleable Iron Part #	316 Stainless Steel Part #
½"	---	<b>50-DC-SS</b> <sup>1</sup>
¾"	---	<b>75-DC-SS</b>
1"	---	<b>100-DC-SS</b>
1½"	---	<b>150-DC-SS</b>
2"	<b>200-DC-MI</b>	<b>200-DC-SS</b>
2½"	---	<b>250-DC-SS</b>
3"	<b>300-DC-MI</b>	<b>300-DC-SS</b>
4"	<b>400-DC-MI</b>	<b>400-DC-SS</b>
5"	---	<b>500-DC-SS</b>
6"	---	<b>600-DC-SS</b>

Dixon® Lockable Dust Caps

Features:

- Buna-N gasket standard, other gaskets available on pages 167 - 170.
- Dust caps and dust plugs are not to be used in pressure applications for safety and environmental reasons.



Size	356T6 Aluminum Part #	Brass Part #
1½"	<b>150DC-LAL</b>	<b>150DC-LBR</b>
2"	<b>200DC-LAL</b>	<b>200DC-LBR</b>
3"	<b>300DC-LAL</b>	<b>300DC-LBR</b>
4"	<b>400DC-LAL</b>	---
6"	<b>600DC-LAL</b>	---



Cam & Groove

Feature:

- angled, ergonomic thumb release

Size	316 Stainless Steel Part #
1½"	<b>150DC-LSS</b>
2"	<b>200DC-LSS</b>
3"	<b>300DC-LSS</b>
4"	<b>400DC-LSS</b>



Boss-Lock™ Type H Dust Caps

Features:

- Buna-N gasket standard, other gaskets available on pages 167 - 170.
- supplied with pull-ring safety clips
- Dust caps and dust plugs are not to be used in pressure applications for safety and environmental reasons.



Size	356T6 Aluminum Part #	Brass Part #
1"	<b>AH100</b>	<b>BH100</b>
1¼"	<b>AH125</b>	<b>BH125</b>
1½"	<b>AH150</b>	<b>BH150</b>
2"	<b>AH200</b>	<b>BH200</b>
2½"	<b>AH250</b>	<b>BH250</b>
3"	<b>AH300</b>	<b>BH300</b>
4"	<b>AH400</b>	<b>BH400</b>
6"	<b>AH600</b>	<b>BH600</b>
8"	<b>AH800</b> <sup>1</sup>	---



356T6 aluminum



brass



plated malleable iron



316 stainless steel

Size	Plated Malleable Iron Part #	316 Stainless Steel Part #
¾"	---	<b>RH075BL</b>
1"	---	<b>RH100BL</b>
1¼"	---	<b>RH125BL</b>
1½"	<b>IH150</b>	<b>RH150BL</b>
2"	<b>IH200</b>	<b>RH200BL</b>
3"	<b>IH300</b>	<b>RH300BL</b>
4"	<b>IH400</b>	<b>RH400BL</b>
6"	<b>IH600</b>	---

<sup>1</sup> Dixon® and Boss-Lock™ cam & groove couplings do not interchange in the 8" size.



EZ Boss-Lock™ Type H Dust Caps

Cam & Groove



356T6 aluminum



brass



316 stainless steel

**Features:**

- Buna-N gasket standard, other gaskets available on pages 167 - 170.
- Dust caps and dust plugs are not to be used in pressure applications for safety and environmental reasons. 

Size	356T6 Aluminum Part #	Brass Part #	316 Stainless Steel Part #
3/4"	---	---	<b>RH075EZ</b>
1"	<b>AH100EZ</b>	<b>BH100EZ</b>	<b>RH100EZ</b>
1 1/4"	---	---	<b>RH125EZ</b>
1 1/2"	<b>AH150EZ</b>	<b>BH150EZ</b>	<b>RH150EZ</b>
2"	<b>AH200EZ</b>	<b>BH200EZ</b>	<b>RH200EZ</b>
2 1/2"	<b>AH250EZ</b>	---	---
3"	<b>AH300EZ</b>	<b>BH300EZ</b>	<b>RH300EZ</b>
4"	<b>AH400EZ</b>	---	<b>RH400EZ</b>
6"	<b>AH600EZ</b>	---	<b>RH600EZ</b>

- Under no circumstances should the EZ Boss-Lock™ cam arms be used on any fitting not specifically designed for their use. See pages 122 and 166 for further specifications. 

Type DP Dust Plugs

- Dust caps and dust plugs are not to be used in pressure applications for safety and environmental reasons.



Size	356T6 Aluminum Part #	Aluminum Hard Coat Part #	Brass Part #
1/2"	---	---	<b>50-DP-BR</b>
3/4"	<b>75-DP-AL</b>	---	<b>75-DP-BR</b>
1"	<b>100-DP-AL</b>	---	<b>100-DP-BR</b>
1 1/4"	<b>125-DP-AL</b>	---	<b>125-DP-BR</b>
1 1/2"	<b>150-DP-AL</b>	<b>150-DP-ALH</b>	<b>150-DP-BR</b>
2"	<b>200-DP-AL</b>	<b>200-DP-ALH</b>	<b>200-DP-BR</b>
2 1/2"	<b>250-DP-AL</b>	---	---
3"	<b>300-DP-AL</b>	<b>300-DP-ALH</b>	<b>300-DP-BR</b>
4"	<b>400-DP-AL</b>	<b>400-DP-ALH</b>	<b>400-DP-BR</b>
5"	<b>500-DP-AL</b>	---	---
6"	<b>600-DP-AL</b>	<b>600-DP-ALH</b>	<b>600-DP-BR</b>
8" DIX	<b>800-DP-AL</b> <sup>1</sup>	---	---
8" BL	<b>801-DP-AL</b> <sup>1</sup>	---	---



356T6 aluminum



aluminum hard coat



brass

<sup>1</sup> Dixon® and Boss-Lock™ cam & groove couplings do not interchange in the 8" size.



Size	Unplated Malleable Iron Part #	Plated Malleable Iron Part #	316 Stainless Steel Part #
1/2"	---	---	<b>50-DP-SS</b> <sup>1</sup>
3/4"	---	---	<b>75-DP-SS</b>
1"	---	---	<b>100-DP-SS</b>
1 1/4"	---	<b>125-DP-PM</b>	<b>125-DP-SS</b>
1 1/2"	<b>150-DP-MI</b>	<b>150-DP-PM</b>	<b>150-DP-SS</b>
2"	<b>200-DP-MI</b>	<b>200-DP-PM</b>	<b>200-DP-SS</b>
2 1/2"	---	<b>250-DP-PM</b>	<b>250-DP-SS</b>
3"	<b>300-DP-MI</b>	<b>300-DP-PM</b>	<b>300-DP-SS</b>
4"	<b>400-DP-MI</b>	<b>400-DP-PM</b>	<b>400-DP-SS</b>
6"	---	---	<b>600-DP-SS</b>



unplated malleable iron



plated malleable iron



316 stainless steel

### Type A Adapters adapter x female NPT

Cam &amp; Groove



Size	Hastelloy® CW12MW Part #
1"	<b>100-A-HA</b>
1½"	<b>150-A-HA</b>
2"	<b>200-A-HA</b>
3"	<b>300-A-HA</b>

- Pressure rating is based on the seal material of the mating part. See rating on page 124

### Type E Adapters adapter x shank



Size	Hastelloy® CW12MW Part #
1"	<b>100-E-HA</b> <sup>1</sup>
1½"	<b>150-E-HA</b>
2"	<b>200-E-HA</b> <sup>1</sup>
3"	<b>300-E-HA</b>

- Pressure rating is based on the seal material of the mating part. See rating on page 124
- <sup>1</sup> have King Crimp™ shank

### Type F Adapters adapter x male NPT



Size	Hastelloy® CW12MW Part #
1"	<b>100-F-HA</b>
1½"	<b>150-F-HA</b>
2"	<b>200-F-HA</b>
3"	<b>300-F-HA</b>

- Pressure rating is based on the seal material of the mating part. See rating on page 124



EZ Boss-Lock™ Type B Couplers  
coupler x male NPT

**Materials:**

- EZ Boss-Lock™ cam arms: 316 stainless steel
- pins: 302 stainless steel
- rings: yellow zinc plated 12 gauge steel wire

**Feature:**

- couplers supplied with FKM gaskets

Size	Hastelloy® CW12MW Part #
1"	<b>HAB100EZ</b>
1½"	<b>HAB150EZ</b>
2"	<b>HAB200EZ</b>
3"	<b>HAB300EZ</b>



Cam & Groove

EZ Boss-Lock™ Type C Couplers  
coupler x hose shank

**Materials:**

- EZ Boss-Lock™ cam arms: 316 stainless steel
- pins: 302 stainless steel
- rings: yellow zinc plated 12 gauge steel wire

**Feature:**

- couplers supplied with FKM gaskets

Size	Hastelloy® CW12MW Part #
1"	<b>HAC100EZ<sup>1</sup></b>
1½"	<b>HAC150EZ</b>
2"	<b>HAC200EZ<sup>1</sup></b>
3"	<b>HAC300EZ</b>



<sup>1</sup> King Crimp™ shank

EZ Boss-Lock™ Type D Couplers  
coupler x female NPT

**Materials:**

- EZ Boss-Lock™ cam arms: 316 stainless steel
- pins: 302 stainless steel
- rings: yellow zinc plated 12 gauge steel wire

**Feature:**

- couplers supplied with FKM gaskets

Size	Hastelloy® CW12MW Part #
1"	<b>HAD100EZ</b>
1½"	<b>HAD150EZ</b>
2"	<b>HAD200EZ</b>
3"	<b>HAD300EZ</b>





## Type DA Couplings with Port coupler x adapter

### Feature:

- Buna-N gasket standard with a, other gaskets available on pages 167 - 170.

Size	Port	316 Stainless Steel Part #
3" x 3"	1/4"	<b>300DAT25SS</b>
3" x 3"	3/8"	<b>300DAT38SS</b>
3" x 3"	1/2"	<b>300DAT50SS</b>
3" x 3"	3/4"	<b>300DAT75SS</b>

## Type DA Jump Size Couplings coupler x adapter

### Feature:

- Buna-N gasket standard with a, other gaskets available on pages 167 - 170.

Size	356T6 Aluminum Part #	316 Stainless Steel Part #
1" x 1 1/2"	<b>1015-DA-AL</b> <sup>1</sup>	<b>1015-DA-SS</b> <sup>1</sup>
1 1/2" x 1"	<b>1510DAAL</b>	<b>1510-DA-SS</b> <sup>1</sup>
1 1/2" x 2"	<b>1520-DA-AL</b>	<b>1520-DA-SS</b>
2" x 1"	<b>2010-DA-AL</b> <sup>1</sup>	<b>2010-DA-SS</b>
2" x 1 1/2"	<b>2015-DA-AL</b>	<b>2015-DA-SS</b>
2" x 2 1/2"	<b>2025-DA-AL</b> <sup>1</sup>	<b>2025-DA-SS</b> <sup>1</sup>
2" x 3"	<b>2030-DA-AL</b>	<b>2030-DA-SS</b>
2" x 4"	<b>2040-DA-AL</b>	<b>2040-DA-SS</b> <sup>1</sup>
2 1/2" x 2"	---	<b>2520-DA-SS</b> <sup>1</sup>
2 1/2" x 3"	---	<b>2530-DA-SS</b> <sup>1</sup>
3" x 1 1/2"	<b>3015-DA-AL</b>	<b>3015-DA-SS</b> <sup>1</sup>
3" x 2"	<b>3020-DA-AL</b>	<b>3020-DA-SS</b>
3" x 2 1/2"	<b>3025-DA-AL</b> <sup>1</sup>	<b>3025-DA-SS</b> <sup>1</sup>
3" x 4"	<b>3040-DA-AL</b>	<b>3040-DA-SS</b>
3" x 6"	<b>3060-DA-AL</b> <sup>1</sup>	<b>3060-DA-SS</b> <sup>1</sup>
4" x 2"	<b>4020-DA-AL</b>	<b>4020-DA-SS</b> <sup>1</sup>
4" x 2 1/2"	<b>4025-DA-AL</b>	<b>4025-DA-SS</b> <sup>1</sup>
4" x 3"	<b>4030-DA-AL</b>	<b>4030-DA-SS</b>
4" x 5"	<b>4050-DA-AL</b>	---
4" x 6"	<b>4060-DA-AL</b>	<b>4060-DA-SS</b> <sup>1</sup>
5" x 3"	<b>5030-DA-AL</b> <sup>1</sup>	<b>5030-DA-SS</b> <sup>1</sup>
5" x 4"	<b>5040-DA-AL</b>	<b>5040-DA-SS</b> <sup>1</sup>
5" x 6"	<b>5060-DA-AL</b> <sup>1</sup>	<b>5060-DA-SS</b> <sup>1</sup>
6" x 3"	<b>6030-DA-AL</b>	<b>6030-DA-SS</b> <sup>1</sup>
6" x 4"	<b>6040-DA-AL</b>	<b>6040-DA-SS</b>
6" x 5"	<b>6050-DA-AL</b>	<b>6050-DA-SS</b> <sup>1</sup>
8" x 6"	<b>8060-DA-AL</b> <sup>1,2</sup>	---

<sup>1</sup> parts are produced as a welded fabrication

<sup>2</sup> The 8" coupler only interchanges with Dixon® adapters.



Size	Brass Part #	Unplated Malleable Iron Part #
3" x 2"	<b>3020-DA-BR</b>	<b>3020-DA-MI</b>
3" x 4"	<b>3040-DA-BR</b>	---
4" x 3"	<b>4030-DA-BR</b>	<b>4030-DA-MI</b>
6" x 4"	<b>6040-DA-BR</b>	<b>6040-DA-MI</b>

Note: In reducing cam & groove couplings, the coupler is the first size in the part number; (i.e., a 4030-DA-AL is a 4" coupler to a 3" adapter).



4030-DA-SS



4060-DA-AL



2015-DA-AL



5060-DA-AL

**Boss-Lock™ Type DA Jump Size  
coupler x adapter**

**Features:**

- Buna-N gasket standard, other gaskets available on pages 167 - 170.
- All Boss-Lock™ couplers are supplied with pull-ring safety clips.

Size	356T6 Aluminum Part #	316 Stainless Steel Part #
2" x 3"	<b>ADA2030</b> <sup>1</sup>	<b>RDA2030BL</b> <sup>1</sup>
2½" x 2"	<b>ADA2520</b> <sup>1</sup>	---
2½" x 3"	<b>ADA2530</b> <sup>1</sup>	---
3" x 2"	<b>ADA3020</b>	<b>RDA3020BL</b>
3" x 4"	<b>ADA3040</b> <sup>1</sup>	<b>RDA3040BL</b> <sup>1</sup>
4" x 2"	<b>ADA4020</b> <sup>1</sup>	<b>RDA4020BL</b> <sup>1</sup>
4" x 3"	<b>ADA4030</b>	<b>RDA4030BL</b>
6" x 4"	<b>ADA6040</b> <sup>1</sup>	---
8" x 6"	<b>ADA8060</b> <sup>1,2</sup>	---

<sup>1</sup> parts are produced as a welded fabrication

<sup>2</sup> The 8" coupler only interchanges with 8" Boss-Lock™ couplings.



Cam & Groove

Note: In reducing cam & groove couplings, the coupler is the first size in the part number; (i.e., a ADA4030 is a 4" coupler to a 3" adapter).

**EZ Boss-Lock™ Type DA Jump Size  
coupler x adapter**

**Feature:**

- Buna-N gasket standard, other gaskets available on pages 167 - 170.

Size	356T6 Aluminum Part #	316 Stainless Steel Part #
2" x 3"	<b>ADA2030EZ</b> <sup>1</sup>	<b>RDA2030EZ</b> <sup>1</sup>
3" x 2"	<b>ADA3020EZ</b>	<b>RDA3020EZ</b>
3" x 4"	<b>ADA3040EZ</b> <sup>1</sup>	<b>RDA3040EZ</b> <sup>1</sup>
4" x 2"	<b>ADA4020EZ</b> <sup>1</sup>	<b>RDA4020EZ</b> <sup>1</sup>
4" x 3"	<b>ADA4030EZ</b>	<b>RDA4030EZ</b>
6" x 4"	<b>ADA6040EZ</b> <sup>1</sup>	<b>RDA6040EZ</b>

<sup>1</sup> parts are produced as a welded fabrication

Note: In reducing cam & groove couplings, the coupler is the first size in the part number; (i.e., a ADA4030EZ is a 4" coupler to a 3" adapter).



**Dixon® Type DA Jump Size with Port  
coupler x adapter**

**Feature:**

- Buna-N gasket standard, other gaskets available on pages 167 - 170.

Size	Port	316 Stainless Steel Part #
3" x 2"	¼"	<b>3020DAT25SS</b>
3" x 2"	⅜"	<b>3020DAT38SS</b>
3" x 2"	½"	<b>3020DAT50SS</b>
3" x 2"	¾"	<b>3020DAT75SS</b>

Note: In reducing cam & groove couplings, the coupler is the first size in the part number; (i.e., a ADA4030EZ is a 4" coupler to a 3" adapter).

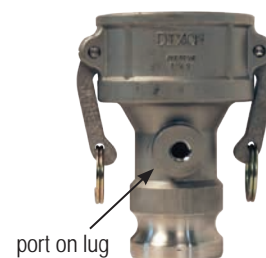

Type DA Spool Adapters  
adapter x adapter

Feature:

- pressure rating is based on the seal of the mating part, see ratings on page 124

Cam & Groove



increaser / reducer



same size

Size	356T6 Aluminum Part #	316 Stainless Steel Part #	Unplated Malleable Iron Part #
1"	---	100-AA-SS	---
1 1/4"	---	125-AA-SS <sup>1</sup>	---
1 1/2"	150-AA-AL	150-AA-SS	---
1 1/2" x 2"	1520-AA-AL	1520-AA-SS	---
2"	200-AA-AL	200-AA-SS	---
2" x 3"	2030-AA-AL	2030-AA-SS	---
2" x 4"	2040-AA-AL	2040-AA-SS <sup>1</sup>	---
2 1/2" x 3"	2530-AA-AL <sup>1</sup>	2530-AA-SS <sup>1</sup>	---
2 1/2" x 4"	2540-AA-AL <sup>1</sup>	---	---
3"	300-AA-AL	300-AA-SS	---
3" x 4"	3040-AA-AL	3040-AA-SS <sup>1</sup>	---
4"	400-AA-AL	400-AA-SS	<b>NEW</b> 400-AA-MI
4" x 5"	4050-AA-AL	---	---
4" x 6"	4060-AA-AL	4060-AA-SS <sup>1</sup>	---
5"	500-AA-AL <sup>1</sup>	500-AA-SS <sup>1</sup>	---
5" x 6"	5060-AA-AL <sup>1</sup>	---	---
6"	600-AA-AL	600-AA-SS <sup>1</sup>	---

<sup>1</sup> parts are produced as a welded fabrication

Size	Brass Part #
2"	200-AA-BR
3"	300-AA-BR

Type DD Dixon® Couplers  
coupler x coupler

Feature:

- Buna-N gasket standard, other gaskets available on pages 167 - 170



reducer / increaser



same size

Size	356T6 Aluminum Part #	316 Stainless Steel Part #
1 1/2"	---	150-DD-SS <sup>1</sup>
2"	200-DD-AL	200-DD-SS
2" x 3"	2030-DD-AL	2030-DD-SS
3"	300-DD-AL	300-DD-SS
3" x 4"	3040-DD-AL	3040-DD-SS <sup>1</sup>
4"	400-DD-AL	400-DD-SS
4" x 5"	4050-DD-AL <sup>1</sup>	4050-DD-SS <sup>1</sup>
4" x 6"	4060-DD-AL <sup>1</sup>	4060-DD-SS
5"	500-DD-AL <sup>1</sup>	500-DD-SS
6"	600-DD-AL	---

<sup>1</sup> parts are produced as a welded fabrication

Type DD Boss-Lock™ Couplers  
coupler x coupler

Features:

- Buna-N gasket standard, other gaskets available on pages 167 - 170
- All Boss-Lock™ couplers are supplied with pull-ring safety clips.



reducer / increaser



same size

Size	356T6 Aluminum Part #	316 Stainless Steel Part #
2"	ADD200 <sup>1</sup>	RDD200EZ
2" x 3"	ADD2030 <sup>1</sup>	RDD2030EZ <sup>1</sup>
3"	ADD300 <sup>1</sup>	RDD300EZ <sup>1</sup>
3" x 4"	ADD3040 <sup>1</sup>	RDD3040EZ <sup>1</sup>
4"	ADD400 <sup>1</sup>	RDD400EZ <sup>1</sup>
6"	---	RDD600EZ <sup>1</sup>

<sup>1</sup> parts are produced as a welded fabrication

Type A Jump Size Adapters

adapter x female NPT

Feature:

- pressure rating is based on the seal of the mating part, see ratings on page 124

Size	356T6 Aluminum Part #	316 Stainless Steel Part #
2" x 1½"	<b>2015-A-AL</b>	<b>2015-A-SS</b> <sup>1</sup>
2" x 3"	<b>2030-A-AL</b>	<b>2030-A-SS</b>
3" x 2"	<b>3020-A-AL</b>	<b>3020-A-SS</b>
3" x 4"	<b>3040-A-AL</b>	---
4" x 3"	<b>4030-A-AL</b>	<b>4030-A-SS</b> <sup>1</sup>
4" x 6"	<b>4060-A-AL</b>	---
6" x 4"	<b>6040-A-AL</b>	<b>6040-A-SS</b> <sup>1</sup>



Cam & Groove

<sup>1</sup> parts are produced as a welded fabrication

Note: In reducing couplings, the cam & groove end is the first size given in the part number. (i.e., a 4030-C-AL is a 4" coupler to a 3" hose shank).

Dixon® Type B Jump Size Couplers  
coupler x male NPT

Feature:

- Buna-N gasket standard, other gaskets available on pages 167 - 170

Size	356T6 Aluminum Part #	316 Stainless Steel Part #
1½" x 1"	<b>1510-B-AL</b>	<b>1510-B-SS</b> <sup>1</sup>
2" x 1½"	<b>2015-B-AL</b>	<b>2015-B-SS</b> <sup>1</sup>
2" x 3"	<b>2030-B-AL</b>	---
3" x 2"	<b>3020-B-AL</b>	<b>3020-B-SS</b> <sup>1</sup>
3" x 4"	<b>3040-B-AL</b>	---
4" x 3"	<b>4030-B-AL</b>	<b>4030-B-SS</b> <sup>1</sup>



<sup>1</sup> parts are produced as a welded fabrication

Note: In reducing couplings, the cam & groove end is the first size given in the part number. (i.e., a 4030-C-AL is a 4" coupler to a 3" hose shank).

Dixon® Type C Jump Size Couplers  
coupler x hose shank

Feature:

- Buna-N gasket standard, other gaskets available on pages 167 - 170

Size	356T6 Aluminum Part #	316 Stainless Steel Part #
1½" x 1"	---	<b>1510-C-SS</b>
2" x 1½"	<b>2015-C-AL</b> <sup>1</sup>	<b>2015-C-SS</b> <sup>1</sup>
3" x 2"	<b>3020-C-AL</b>	<b>3020-C-SS</b>
3" x 2½"	---	<b>3025-C-SS</b>
3" x 4"	<b>3040-C-AL</b>	---
4" x 3"	<b>4030-C-AL</b>	<b>4030-C-SS</b> <sup>1</sup>
5" x 4"	<b>5040-C-AL</b> <sup>1</sup>	---

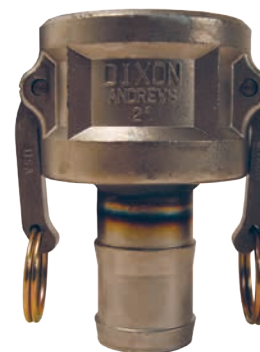

<sup>1</sup> parts are produced as a welded fabrication

Note: In reducing couplings, the cam & groove end is the first size given in the part number. (i.e., a 4030-C-AL is a 4" coupler to a 3" hose shank).

## Dixon® Type D Jump Size Couplers coupler x female NPT

Cam &amp; Groove

**Feature:**

- Buna-N gasket standard, other gaskets available on pages 167 - 170

Size	356T6 Aluminum Part #	Optional Qty	Brass Part #	316 Stainless Steel Part #
1½" x 1"	<b>1510-D-AL</b>	10	---	<b>1510-D-SS</b> <sup>1</sup>
2" x 1½"	<b>2015-D-AL</b>	10	---	<b>2015-D-SS</b>
3" x 2"	<b>3020-D-AL</b>	10	---	<b>3020-D-SS</b>
4" x 3"	<b>4030-D-AL</b>	10	<b>4030-D-BR</b>	<b>4030-D-SS</b> <sup>1</sup>
5" x 4"	<b>5040-D-AL</b> <sup>1</sup>	---	---	---
6" x 4"	<b>6040-D-AL</b> <sup>1</sup>	---	---	---

<sup>1</sup> parts are produced as a welded fabrication

Note: In reducing couplings, the cam & groove end is the first size given in the part number. (i.e., a 4030-C-AL is a 4" coupler to a 3" hose shank).

## Type E Jump Size Adapters adapter x hose shank

**Feature:**

- pressure rating is based on the seal of the mating part, see ratings on page 124



Size	356T6 Aluminum Part #	316 Stainless Steel Part #
1½" x 1"	---	<b>1510-E-SS</b>
2" x 1½"	<b>2015-E-AL</b> <sup>1</sup>	<b>2015-E-SS</b> <sup>1</sup>
3" x 2"	---	<b>3020-E-SS</b> <sup>1</sup>
3" x 2½"	---	<b>3025-E-SS</b>
4" x 3"	<b>4030-E-AL</b>	<b>4030-E-SS</b> <sup>1</sup>
5" x 4"	<b>5040-E-AL</b> <sup>1</sup>	---

<sup>1</sup> parts are produced as a welded fabrication

Note: In reducing couplings, the cam & groove end is the first size given in the part number. (i.e., a 4030-B-AL is a 4" coupler to a 3" male NPT).

## Type F Jump Size Adapters adapter x male NPT

**Feature:**

- pressure rating is based on the seal of the mating part, see ratings on page 124



Size	356T6 Aluminum Part #	316 Stainless Steel Part #
1½" x 2"	<b>1520-F-AL</b>	---
2" x 1½"	<b>2015-F-AL</b>	<b>2015-F-SS</b> <sup>1</sup>
2" x 3"	<b>2030-F-AL</b>	---
3" x 1½"	<b>3015-F-AL</b>	<b>3015-F-SS</b> <sup>1</sup>
3" x 2"	<b>3020-F-AL</b>	<b>3020-F-SS</b>
3" x 4"	<b>3040-F-AL</b>	---
4" x 3"	<b>4030-F-AL</b>	<b>4030-F-SS</b>

<sup>1</sup> parts are produced as a welded fabrication

Note: In reducing couplings, the cam & groove end is the first size given in the part number. (i.e., a 4030-C-AL is a 4" coupler to a 3" hose shank).

Dixon® Type DA 45° Elbows  
adapter x coupler

Feature:

- Buna-N gasket standard, other gaskets available on pages 167 - 170

Size	356T6 Aluminum Part #	316 Stainless Steel Part #	Unplated Malleable Iron Part #
2"	<b>200DA-45AL</b> <sup>1</sup>	<b>200DA-45SS</b> <sup>1</sup>	---
3"	<b>300DA-45AL</b>	<b>300DA-45SS</b> <sup>1</sup>	---
4"	<b>400DA-45AL</b>	<b>400DA-45SS</b> <sup>1</sup>	<b>400DA-45MI</b>
6"	<b>600DA-45AL</b>	---	---

<sup>1</sup> part is produced as a welded fabrication



Cam & Groove

Dixon® Type DD 45° Elbows  
coupler x coupler

Feature:

- Buna-N gasket standard, other gaskets available on pages 167 - 170

Size	356T6 Aluminum Part #	316 Stainless Steel Part #
2"	<b>200DD-45AL</b> <sup>1</sup>	---
3"	<b>300DD-45AL</b> <sup>1</sup>	<b>300DD-45SS</b> <sup>1</sup>
4"	<b>400DD-45AL</b>	---
6"	<b>600DD-45AL</b> <sup>1</sup>	---

<sup>1</sup> part is produced as a welded fabrication



C

Dixon® Type DA 90° Elbows  
adapter x coupler

Feature:

- Buna-N gasket standard, other gaskets available on pages 167 - 170

Size	356T6 Aluminum Part #	316 Stainless Steel Part #
1"	---	<b>100DA-90SS</b> <sup>1</sup>
1½"	<b>150DA-90AL</b> <sup>1</sup>	<b>150DA-90SS</b> <sup>1</sup>
2"	<b>200DA-90AL</b>	<b>200DA-90SS</b>
3"	<b>300DA-90AL</b>	<b>300DA-90SS</b>
4"	<b>400DA-90AL</b>	<b>400DA-90SS</b>
5"	<b>500DA-90AL</b> <sup>1</sup>	---
6"	<b>600DA-90AL</b>	<b>RDA90600EZ</b> <sup>1,2</sup>

<sup>1</sup> part is produced as a welded fabrication

<sup>2</sup> EZ Boss-Lock™ design (not pictured)



Dixon® Type DD 90° Elbows  
coupler x coupler

Feature:

- Buna-N gasket standard, other gaskets available on pages 167 - 170

Size	356T6 Aluminum Part #	316 Stainless Steel Part #
2"	<b>200DD-90AL</b>	---
3"	<b>300DD-90AL</b> <sup>1</sup>	<b>300DD-90SS</b> <sup>1</sup>
4"	<b>400DD-90AL</b>	---
6"	<b>600DD-90AL</b>	---

<sup>1</sup> part is produced as a welded fabrication



Type A 90° Adapters Elbows  
adapter x female NPT

Feature:

- pressure rating is based on the seal of the mating part, see ratings on page 124

Size	356T6 Aluminum Part #	316 Stainless Steel Part #
1½"	<b>150A-90AL</b>	---
2"	<b>200A-90AL</b>	<b>200A-90SS</b> <sup>1</sup>
3"	<b>300A-90AL</b>	<b>300A-90SS</b>
4"	<b>400A-90AL</b>	---

<sup>1</sup> part is produced as a welded fabrication



Type B 90° Dixon® Elbows  
coupler x male NPT

Cam & Groove



**Feature:**

- Buna-N gasket standard, other gaskets available on pages 167 - 170

Size	356T6 Aluminum Part #	316 Stainless Steel Part #
1½"	<b>150B-90AL</b>	---
2"	<b>200B-90AL</b>	<b>200B-90SS</b> <sup>1</sup>
3"	---	<b>300B-90SS</b> <sup>1</sup>

<sup>1</sup> Parts are produced as a welded fabrication.

Type C 90° Dixon® Elbows  
coupler x hose shank

C



**Feature:**

- Buna-N gasket standard, other gaskets available on pages 167 - 170

Size	356T6 Aluminum Part #	Brass Part #	316 Stainless Steel Part #
1¼"	---	<b>125C-90BR</b>	---
1½"	<b>150C-90AL</b>	---	<b>150C-90SS</b>
2"	<b>200C-90AL</b>	<b>200C-90BR</b>	<b>200C-90SS</b>
3"	<b>300C-90AL</b>	---	<b>300C-90SS</b>
4"	<b>400C-90AL</b>	---	<b>400C-90SS</b> <sup>1</sup>
6"	<b>600C-90AL</b>	---	---

<sup>1</sup> part is produced as a welded fabrication

Type D 90° Dixon® Elbows  
coupler x female NPT



EZ Boss-Lock™ design

**Feature:**

- Buna-N gasket standard, other gaskets available on pages 167 - 170

Size	356T6 Aluminum Part #	Brass Part #	316 Stainless Steel Part #
1"	---	---	<b>100D-90SS</b>
1¼"	---	<b>125D-90BR</b>	---
1½"	<b>150D-90AL</b>	<b>150D-90BR</b>	---
2"	<b>200D-90AL</b>	<b>200D-90BR</b>	<b>200D-90SS</b>
3"	<b>300D-90AL</b>	---	<b>300D-90SS</b>
4"	<b>400D-90AL</b>	---	<b>400D-90SS</b> <sup>1</sup>
4"	<b>AD90400EZ</b> <sup>2</sup>	---	---
6"	<b>600D-90AL</b>	---	---

<sup>1</sup> part is produced as a welded fabrication

<sup>2</sup> EZ Boss-Lock™ design



Type E 90° Elbows  
adapter x hose shank

**Feature:**

- pressure rating is based on the seal of the mating part, see ratings on page 124

Size	356T6 Aluminum Part #	316 Stainless Steel Part #
2"	---	200E-90SS <sup>1</sup>
3"	300E-90AL	300E-90SS
4"	400E-90AL	400E-90SS <sup>1</sup>

<sup>1</sup> parts are produced as a welded fabrication



Cam & Groove

Type F 90° Elbows  
adapter x male NPT

**Feature:**

- pressure rating is based on the seal of the mating part, see ratings on page 124

Size	356T6 Aluminum Part #	316 Stainless Steel Part #
1½"	150F-90AL	---
2"	200F90AL	200F-90SS <sup>1</sup>
3"	---	300F-90SS <sup>1</sup>

<sup>1</sup> parts are produced as a welded fabrication



Adapter x 150# Flange

Cam & Groove

Features:

- aluminum and unplated iron flanges are flat faced
- stainless steel flanges are raised face
- reference dixonvalve.com for flange bolt hole drilling circle standards
- flanges are designed to mate with 150# flange
- flanges have the same bolt hole pattern as an ANSI 150 lb. flange, the thickness may vary



Size	356T6 Aluminum Part #	Flange Thick.	Unplated Malleable Iron Part #	Flange Thick.	316 Stainless Steel Part #	Flange Thick.
1"	---	---	---	---	100-AL-SS	9/16"
1½"	---	---	---	---	150-AL-SS	11/16"
2"	200-AL-AL	¾"	---	---	200-AL-SS	7/16"
3"	300-AL-AL	⅝"	300-AL-MI	⅝"	300-AL-SS	7/16"
4"	400-AL-AL	⅝"	---	---	400-AL-SS	7/16"
6"	600-AL-AL	⅝"	---	---	600-AL-SS	5/8"
8"	800-AL-AL <sup>1</sup>	1⅛"	---	---	---	---

- <sup>1</sup> part is produced as a welded fabrication
- For flange dimensions, diagrams and additional information please reference dixonvalve.com.

Adapter x 150# ANSI Flange

Feature:

- global product made to Dixon® specifications



Size	316 Stainless Steel Part #	Flange Thickness
2"	200-AL-SSANSI	¾"
3"	300-AL-SSANSI	15/16"

- For flange dimensions, diagrams and additional information please reference dixonvalve.com.

Dixon® Coupler x 150# Flange

Feature:

- Buna-N gasket standard, other gaskets available on pages 167 - 170



Size	356T6 Aluminum Part #	Flange Thick	316 Stainless Steel Part #	Flange Thick.
1"	---	---	100-DL-SS	21/32"
1½"	---	---	150-DL-SS	25/32"
2"	200-DL-AL	3/4"	200-DL-SS	7/16"
3"	300-DL-AL	15/16"	300-DL-SS	7/16"
4"	400-DL-AL	15/16"	400-DL-SS	7/16"
6"	600-DL-AL	1"	600-DL-SS	5/8"
8"	800-DL-AL <sup>1</sup>	1-1/8"	---	---

- <sup>1</sup> part is produced as a welded fabrication
- For flange dimensions, diagrams and additional information please reference dixonvalve.com.

EZ Boss-Lock™ Coupler x 150# Flange

Feature:

- Buna-N gasket standard, other gaskets available on pages 167 - 170



Size	316 Stainless Steel Part #	Flange Thickness
1"	RDL100EZ <sup>1</sup>	9/16"
1½"	RDL150EZ <sup>1</sup>	11/16"
2"	RDL200EZ	7/16"
3"	RDL300EZ <sup>1</sup>	7/16"
4"	RDL400EZ <sup>1</sup>	7/16"
6"	RDL600EZ <sup>1</sup>	1"

- <sup>1</sup> parts are produced as a welded fabrication
- For flange dimensions, diagrams and additional information please reference dixonvalve.com.

**Features:**

- not all configurations are stocked
- Boss-Lock™ versions are also available, consult Dixon® for pricing and availability
- CAD models are for reference only, consult Dixon® for specific dimensions
- final weld preparation, as with all weld fittings, is the responsibility of the welder



Dixon® Coupler Socket Weld to Schedule 40 Pipe

Size	Bore	356T6 Aluminum Part #	316 Stainless Steel Part #
¾"	1.065	---	75DWSPSS
1"	1.330	100DWSPAL	100DWSPSS
1½"	1.915	150DWSPAL	150DWSPSS
2"	2.390	200DWSPAL	200DWSPSS
3"	3.530	300DWSPAL	300DWSPSS
4"	4.530	400DWSPAL	400DWSPSS
5"	5.562	500DWSPAL	500DWSPSS
6"	6.655	600DWSPAL	600DWSPSS
8"	8.711	800DWSPAL <sup>1</sup>	---



Cam & Groove



<sup>1</sup> Dixon® and Boss-Lock™ cam & groove couplings *do not interchange in the 8" size*. The 8" Dixon® design has 4 cam arms.



Dixon® Coupler Butt Weld to Schedule 40 Pipe/Socket Weld to Nominal Tubing

Size	Bore	356T6 Aluminum Part #	316 Stainless Steel Part #
¾"	.765	---	75DWPSTSS
1"	1.015	---	100DWPSTSS
1½"	1.515	150DWPSTAL	150DWPSTSS
2"	2.015	200DWPSTAL	200DWPSTSS
3"	3.015	300DWPSTAL	300DWPSTSS
4"	4.015	400DWPSTAL	400DWPSTSS
5"	5.015	500DWPSTAL	---
6"	6.020	600DWPSTAL	---



EZ Boss-Lock™ Coupler Socket Weld to Schedule 40 Pipe

Size	Bore	316 Stainless Steel Part #
¾"	1.065	RDWSP075EZ
1"	1.330	RDWSP100EZ
1½"	1.915	RDWSP150EZ
2"	2.390	RDWSP200EZ
3"	3.530	RDWSP300EZ
4"	4.530	RDWSP400EZ
6"	6.655	RDWSP600EZ



EZ Boss-Lock™ Coupler Butt Weld to Schedule 40 Pipe / Socket Weld to Nominal Tubing

Cam & Groove

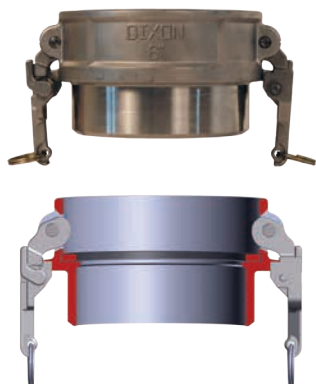

- Buna-N gaskets standard, other gaskets available on pages 167 - 170

Size	Bore	316 Stainless Steel Part #	
¾"	.765	<b>RDWBPST075EZ</b>	
1"	1.015	<b>RDWBPST100EZ</b>	
1½"	1.515	<b>RDWBPST150EZ</b>	
2"	2.015	<b>RDWBPST200EZ</b>	
3"	3.015	<b>RDWBPST300EZ</b>	
4"	4.015	<b>RDWBPST400EZ</b>	
6"	6.020	<b>RDWBPST600EZ</b>	

Adapter Socket Weld to Schedule 40 Pipe

- not all configurations are stocked



Size	Bore	356T6 Aluminum Part #	316 Stainless Steel Part #
¾"	1.065	---	<b>75AWSPSS</b>
1"	1.330	---	<b>100AWSPSS</b>
1½"	1.915	<b>150AWSPAL</b>	<b>150AWSPSS</b>
2"	2.390	<b>200AWSPAL</b>	<b>200AWSPSS</b>
3"	3.530	<b>300AWSPAL</b>	<b>300AWSPSS</b>
4"	4.530	<b>400AWSPAL</b>	<b>400AWSPSS</b>
5"	5.593	<b>500AWSPAL</b>	<b>500AWSPSS</b>
6"	6.655	<b>600AWSPAL</b>	<b>600AWSPSS</b>
8" DIX	8.711	<b>800AWSPAL</b> <sup>1</sup>	---
8" BL	8.711	<b>801AWSPAL</b> <sup>1</sup>	---

- <sup>1</sup> Dixon® and Boss-Lock™ cam & groove couplings *do not interchange in the 8" size.*
- final weld preparation, as with all weld fittings, is the responsibility of the welder



Adapter Butt Weld to Schedule 40 Pipe/Socket Weld to Nominal Tubing



Size	Bore	356T6 Aluminum Part #	316 Stainless Steel Part #
¾"	.765	---	<b>75AWBPSTSS</b>
1"	1.015	---	<b>100AWBPSTSS</b>
1½"	1.515	<b>150AWBPSTAL</b>	<b>150AWBPSTSS</b>
2"	2.015	<b>200AWBPSTAL</b>	<b>200AWBPSTSS</b>
3"	3.015	<b>300AWBPSTAL</b>	<b>300AWBPSTSS</b>
4"	4.015	<b>400AWBPSTAL</b>	<b>400AWBPSTSS</b>
5"	5.015	<b>500AWBPSTAL</b>	<b>500AWBPSTSS</b>
6"	6.020	<b>600AWBPSTAL</b>	<b>600AWBPSTSS</b>
8" BL	8.035	<b>801AWBPSTAL</b> <sup>1</sup>	---

- <sup>1</sup> Dixon® and Boss-Lock™ cam & groove couplings *do not interchange in the 8" size.*



Boss-Lock™ Coupler x Tube with 45° Cut

**Application:**

- for use on trailer relief valves

**Features:**

- butt weld to tubing
- Buna-N gaskets standard, other gaskets available on pages 167 - 170
- All Boss-Lock™ couplers are supplied with pull-ring safety clips



Cam & Groove

Size	356T6 Aluminum Part #
2"	<b>AC200TUBE</b>

In-Line Sight Glasses

**Application:**

- designed for dry bulk transfer hose

**Materials:**

- body: aluminum
- seals: Buna
- sight glass: acrylic
- hardware: stainless steel
- cam arms (where applicable): bronze

**Feature:**

- not intended for liquid service, for dry bulk transfer *only*



Coupler x Adapter

Size	Aluminum Part #
3" x 3"	<b>3533CA</b>
3" x 4"	<b>3534CA</b>
4" x 3"	<b>3543CA</b>
4" x 4"	<b>3544CA</b>



Adapter x Adapter

Size	Aluminum Part #
3" x 3"	<b>3533AA</b>
3" x 4"	<b>3534AA</b>
4" x 4"	<b>3544AA</b>



Coupler x Coupler

Size	Aluminum Part #
3" x 3"	<b>3533CC</b>
4" x 3"	<b>3543CC</b>
4" x 4"	<b>3544CC</b>



## Adapter x Female NPSM

**Application:**

- used in the delivery of dry goods

**Features:**

- cork buna gaskets are standard in threaded end
- pressure rating is based on the seal of the mating part, see ratings on page 124
- replacement gasket; **400GAGFI**

Size	356T6 Aluminum Part #
4"	<b>400-AS-AL</b>

## Boss-Lock™ Coupler x Female NPSM

**Features:**

- Buna-N gasket standard, other gaskets available on pages 167 - 170
- All Boss-Lock™ couplers are supplied with pull-ring safety clips

Size	356T6 Aluminum Part #
4"	<b>ADS400</b>

## Dixon® Coupler x Adapter Wye

**Feature:**

- Buna-N gasket standard, other gaskets available on pages 167 - 170

Size	356T6 Aluminum Part #
2"	<b>200YDAAAL</b>

### Dixon® Cam & Groove Handles

**Features:**

- stainless steel pins standard with all assemblies
- roll pins are 302 stainless, solid pins are 303 stainless
- pull rings are standard on sizes 1 ¼" thru 6", optional on other sizes
- Domestic Dixon® standard handle assemblies are only to be used with standard Dixon® parts (not global). Handles do not interchange with other manufacturer's handles or couplers. 

Coupler Size	Description	Brass Part #	316 Sintered Stainless Steel Part #
½"	cam arm and pin	---	<b>50-HP-SP</b>
¾"	cam arm and pin	---	<b>75-HP-SP</b>
1"	cam arm and pin	---	<b>100-HP-SP</b>
1 ¼" - 2 ½"	cam arm, ring and pin	<b>200-HRP-BR</b>	<b>200-HRP-SP</b>
3" - 5"	cam arm, ring and pin	<b>300-HRP-BR</b>	<b>300-HRP-SP</b>
6"	cam arm, ring and pin	<b>600-HRP-BR</b>	---
8"	cam arm and pin	<b>800-HNP-BR</b>	---



brass

Cam & Groove



316 sintered stainless steel



316 investment stainless steel

C

Coupler Size	Description	316 Investment Stainless Steel Part #
2"	cam arm, ring and pin	<b>200-HSCR-SP</b>
3"	cam arm, ring and pin	<b>300-HSCR-SP</b>
6"	cam arm, ring and pin	<b>600-HRP-SP</b>

### Dixon® Cam & Groove Locking Handles for Dust Caps

**Features:**

- Dixon® locking handles are only to be used with standard Dixon® parts (not global). Handles do not interchange with other manufacturer's handles or couplers. 
- not supplied with pins

Coupler Size	Hole Diameter	Brass Part #	316 Investment Stainless Steel Part #
2"	9/32"	<b>200-LH-BR</b>	<b>200-LH-SI</b>
3"	5/16"	<b>300-LH-BR</b>	<b>300-LH-SI</b>
4"	¾"	<b>400-LH-BR</b>	<b>400-LH-SI</b>



200-LH-SI



300-LH-BR

### Boss-Lock™ Cam & Groove Handles

**Feature:**

- Boss-Lock™ handles should only be used with Boss-Lock™ parts. Handles do not interchange with other manufacturer's handles or couplers. 

Coupler Size	Brass Part #	316 Investment Stainless Steel Part #	Plated Iron Part #
¾" - 1"	<b>BHSC175</b>	<b>RHSC175</b>	---
1 ¼" - 2 ½"	<b>BHSC152</b>	<b>RHSC152</b>	<b>IHSC152</b>
3" and 4"	<b>BHSC34</b>	<b>RHSC34</b>	<b>IHSC34</b>



IHSC152



IH6

Coupler Size	Brass Part #	Plated Iron Part #
6" and 8"	<b>BH6</b>	<b>IH6</b>

## EZ Boss-Lock™ Cam & Groove Handles

Cam & Groove



**Features:**

- investment cast stainless steel cam arm and lever
- 316 stainless steel spring
- stainless steel pin, washer, plated carbon steel pull ring

Coupler Size	Brass Part #
¾" - 1"	<b>RHEZ175</b>
1¼" - 2½"	<b>RHEZ152</b>
3" - 5"	<b>RHEZ34</b>
6" and 8"	<b>RHEZ6</b>

Under no circumstances should the EZ Boss-Lock™ cam arms be used on any fitting not specifically produced for their use. The aluminum, brass and iron are made from sand castings. To ensure proper functioning of the EZ Boss-Lock™ cam arm assemblies, we sort the castings to ensure there is sufficient length and orientation on the lugs on the main casting to engage the lever. We also buff or grind the rougher sand cast surface to ensure that the lever will move freely. *The EZ Boss-Lock™ cam arms cannot be retrofitted onto existing aluminum, brass or plated iron Boss-Lock™ already in service.*



## Dixon® Coupling Paddle Handles



316 investment cast stainless steel



brass

**Features:**

- Dixon® paddle handles are only to be used with standard Dixon® parts (not global). Handles do not interchange with other manufacturer's handles or couplers.
- not supplied with pins



Coupler Size	Brass Part #	316 Investment Cast Stainless Steel Part #
3" and 4"	<b>300H-PADBR</b>	<b>300H-PADSS</b>



Cam & Groove Gasket Dimensions

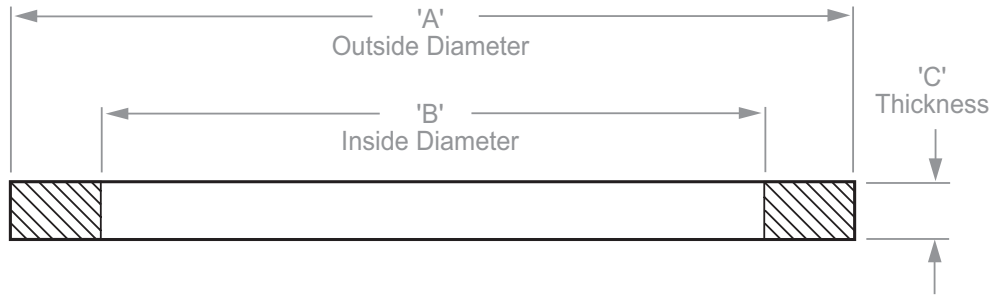

- nominal dimensions for elastomeric cam & groove gaskets are listed
- ID's of the PTFE envelope gaskets and the PTFE accordion gaskets are *1/16" smaller than* the ID's for the elastomeric gaskets shown below
- thickness of PTFE accordion gaskets may vary from chart below

Size	Part #	Dimensions		
		A	B	C
1/2"	<b>50-G</b> <sup>1</sup>	1-1/32"	11/16"	.156"
3/4"	<b>75-G</b>	1-3/8"	7/8"	.218"
1"	<b>100-G</b>	1-9/16"	1-1/16"	.250"
1 1/4"	<b>125-G</b>	1-15/16"	1-23/64"	.250"
1 1/2"	<b>150-G</b>	2-3/16"	1-5/8"	.250"
2"	<b>200-G</b>	2-5/8"	2"	.250"
2 1/2"	<b>250-G</b>	3-1/8"	2-3/8"	.250"
3"	<b>300-G</b>	3-23/32"	3"	.250"
4"	<b>400-G</b>	4-7/8"	4"	.250"
5"	<b>500-G</b>	5-15/16"	4-7/8"	.250"
6"	<b>600-G</b>	7-1/16"	6"	.250"
8"	<b>800-G</b> <sup>1</sup>	9-5/16"	8-1/8"	.343"

<sup>1</sup> No interchange standard exists for the 1/2" and 8" fittings. Generally, these sizes do not interchange with other manufacturer's products. As such, the gaskets in these sizes are not suitable for use in other manufacturers' couplings.



Cam & Groove Gasket Color Codes

Gasket Code <sup>1</sup>	Material	Color	Color code stripes (appear on the OD of the gasket or filler)
<b>-BU</b>	<i>Buna-N</i> (standard in all metal fittings)	black	1 blue
<b>-BF</b>	<i>Buna</i> (formulated for fuel service)	black	1 green
<b>-VI</b>	<i>FKM</i>	black	1 yellow
<b>-THK</b>	<i>Extra Thick Buna</i>	black	2 blue
<b>-EPR</b>	<i>Ethylene Propylene</i>	black	1 white
<b>-NE</b>	<i>Neoprene</i>	black	1 red
<b>-WNE</b>	<i>White Neoprene</i> , FDA approved material	white	none
<b>-WB</b>	<i>White Buna-N</i> , FDA approved material	white	blue
<b>-SIL</b>	<i>Silicone</i>	red	none
<b>-TF</b>	<i>PTFE (TFE) envelope with Buna-N filler</i>	white / black	1 blue
<b>TFVI</b>	<i>PTFE (TFE) envelope with FKM filler</i>	white / black	1 yellow
<b>TFWB</b>	<i>PTFE (TFE) envelope with White Buna-N filler</i> , FDA approved materials	white / white	blue
<b>TFEP</b>	<i>PTFE (TFE) envelope with Ethylene Propylene filler</i>	white / black	1 white stripe
<b>-TES</b>	<i>PTFE (FEP) encapsulated Silicone core</i> , FDA approved materials	translucent / red	none
<b>-TEV</b>	<i>PTFE (FEP) encapsulated FKM core</i>	translucent / black	none
<b>TFACC</b>	<i>PTFE (TFE) accordion</i> , FDA approved materials	white	none

<sup>1</sup> part number suffix

Since other manufacturer's coding systems vary, this chart should not be used as a reference in identifying gaskets of unknown origin.



Cam & Groove Gaskets

Cam & Groove



Buna-N



FKM

Size	Buna-N Part #	FKM Part #
½"	<b>50-G-BU</b>	<b>50-G-VI</b>
¾"	<b>75-G-BU</b>	<b>75-G-VI</b>
1"	<b>100-G-BU</b>	<b>100-G-VI</b>
1¼"	<b>125-G-BU</b>	<b>125-G-VI</b>
1½"	<b>150-G-BU</b>	<b>150-G-VI</b>
2"	<b>200-G-BU</b>	<b>200-G-VI</b>
2½"	<b>250-G-BU</b>	<b>250-G-VI</b>
3"	<b>300-G-BU</b>	<b>300-G-VI</b>
4"	<b>400-G-BU</b>	<b>400-G-VI</b>
5"	<b>500-G-BU</b>	<b>500-G-VI</b>
6"	<b>600-G-BU</b>	<b>600-G-VI</b>
8"	<b>800-G-BU</b>	<b>800-G-VI</b>

C



extra thick Buna-N



ethylene propylene

Size	extra thick Buna-N Part #	Ethylene Propylene Part #
¾"	---	<b>75-G-EPR</b>
1"	<b>100GTHK</b>	<b>100-G-EPR</b>
1¼"	<b>125GTHK</b>	<b>125-G-EPR</b>
1½"	<b>150GTHK</b>	<b>150-G-EPR</b>
2"	<b>200GTHK</b>	<b>200-G-EPR</b>
2½"	<b>250GTHK</b>	<b>250-G-EPR</b>
3"	<b>300GTHK</b>	<b>300-G-EPR</b>
4"	<b>400GTHK</b>	<b>400-G-EPR</b>
6"	<b>600GTHK</b>	---

**NEW**



neoprene



white neoprene

Size	Neoprene Part #	white Neoprene <sup>1</sup> Part #
¾"	<b>75-G-NE</b>	---
1"	<b>100-G-NE</b>	---
1¼"	<b>125-G-NE</b>	---
1½"	<b>150-G-NE</b>	<b>150-G-WNE</b>
2"	<b>200-G-NE</b>	<b>200-G-WNE</b>
2½"	<b>250-G-NE</b>	---
3"	<b>300-G-NE</b>	<b>300-G-WNE</b>
4"	<b>400-G-NE</b>	<b>400-G-WNE</b>
5"	---	<b>500-G-WNE</b>
6"	---	<b>600-G-WNE</b>

<sup>1</sup> white neoprene gaskets contain FDA approved materials



white Buna-N



silicone

Size	white Buna-N <sup>1</sup> Part #	Silicone Part #
1½"	---	<b>150-G-SIL</b>
2"	---	<b>200-G-SIL</b>
3"	<b>300-G-WB</b>	<b>300-G-SIL</b>
4"	<b>400-G-WB</b>	<b>400-G-SIL</b>

<sup>1</sup> white Buna-N gaskets contain FDA approved materials

Fuel Gaskets

Size	Material	Part #
1½"	<i>Buna</i>	<b>150-G-BF</b>
2"	<i>Buna</i>	<b>200-G-BF</b>
3"	<i>Buna</i>	<b>300-G-BF</b>
4"	<i>Buna</i>	<b>400-G-BF</b>
3"	<i>extra thick Buna-N</i>	<b>300GTHKBF</b>
4"	<i>extra thick Buna-N</i>	<b>400GTHKBF</b>



Cam & Groove

Cam & Groove Envelope Gaskets

Features:

- PTFE white Buna filler (TFWB) contains FDA approved materials
- maximum operating temperatures for specific chemicals may be lower, contact Dixon® for specific recommendations

Size	PTFE (TFE) with Buna-N filler Part #	PTFE (TFE) with FKM filler Part #
½"	<b>50-G-TF</b>	<b>50-G-TF-VI</b>
¾"	<b>75-G-TF</b>	<b>75-G-TF-VI</b>
1"	<b>100-G-TF</b>	<b>100GTFVI</b>
1¼"	<b>125-G-TF</b>	<b>125GTFVI</b>
1½"	<b>150-G-TF</b>	<b>150GTFVI</b>
2"	<b>200-G-TF</b>	<b>200GTFVI</b>
2½"	<b>250-G-TF</b>	<b>250GTFVI</b>
3"	<b>300-G-TF</b>	<b>300GTFVI</b>
4"	<b>400-G-TF</b>	<b>400GTFVI</b>
6"	<b>600-G-TF</b>	<b>600GTFVI</b>

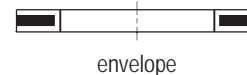

envelope

Size	PTFE (TFE) with white Buna-N filler Part #	PTFE (TFE) with Ethylene Propylene filler Part #
1½"	---	<b>150GTFEP</b>
2"	<b>200GTFWB</b>	<b>200GTFEP</b>
3"	<b>300GTFWB</b>	<b>300GTFEP</b>
4"	<b>400GTFWB</b>	---
5"	<b>500GTFWB</b>	---

The torque (force) required to close the handles on a pair of cam and groove fittings will vary according to the gasket chosen. Due to the nature of the PTFE material, the various PTFE gasket designs will require the most torque, increasing as you go from envelope to encapsulated, and finally, accordion.

## Cam & Groove Encapsulated Gaskets

**Features:**

- *PTFE encapsulated silicone* (TES) gaskets contain FDA approved materials
- encapsulated gasket pressure ratings are reduced to **125 PSI** for ¾" - 4" at ambient temperature **70°F (21°C)**
- *PTFE encapsulated FKM* (TEV) gaskets - maximum operating temperature **200°F (93°C)**
- *PTFE encapsulated silicone* (TES) gaskets - maximum operating temperature **225°F (107°C)**
- maximum operating temperatures for specific chemicals may be lower, contact Dixon® for specific recommendations



Size	<i>PTFE (FEP) encapsulated silicone</i> Part #	<i>PTFE (FEP) encapsulated FKM</i> Part #
¾"	<b>75-G-TES</b>	<b>75-G-TEV</b>
1"	<b>100-G-TES</b>	<b>100-G-TEV</b>
1¼"	<b>125-G-TES</b>	<b>125-G-TEV</b>
1½"	<b>150-G-TES</b>	<b>150-G-TEV</b>
2"	<b>200-G-TES</b>	<b>200-G-TEV</b>
2½"	<b>250-G-TES</b>	<b>250-G-TEV</b>
3"	<b>300-G-TES</b>	<b>300-G-TEV</b>
4"	<b>400-G-TES</b>	<b>400-G-TEV</b>

## Cam & Groove Accordion Gaskets

**Features:**

- *PTFE* accordion gaskets (TFACC) are recommended for use with viscous (thick) fluids only 
- maximum operating temperatures for specific chemicals may be lower, contact Dixon® for specific recommendations

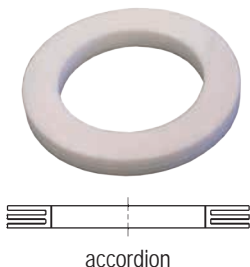

Size	<i>PTFE (TFE)</i> Part #
¾"	<b>75GTFACC</b>
1"	<b>100GTFACC</b>
1¼"	<b>125GTFACC</b>
1½"	<b>150GTFACC</b>
2"	<b>200GTFACC</b>
3"	<b>300GTFACC</b>

The torque (force) required to close the handles on a pair of cam & groove fittings will vary according to the gasket chosen. Due to the nature of the PTFE material, the various PTFE gasket designs will require the most torque, increasing as you go from envelope to encapsulated, and finally, accordion.

### Witches Hat Strainers

**Features:**

- used with female cam and groove couplings
- pre-attached Buna-N gasket

Size	304 Stainless Steel Part #
3"	<b>WH300-A</b>
4"	<b>WH400-A</b>

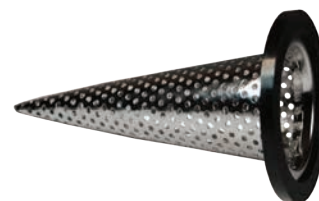

Cam & Groove

### Gaskets for Witches Hat Strainers

Size	Buna-N Gasket Part #
3"	<b>WH300-G</b>
4"	<b>WH400-G</b>



### Disk Strainers

**Feature:**

- threads into bottom of female NPT fitting to protect equipment from large contaminants

Size	Hole Size	6061T6 Aluminum	304 Investment Cast
		Part #	Stainless Steel Part #
2"	¼"	<b>SDA200</b>	<b>SDS200</b>
3"	¼"	<b>SDA300</b>	<b>SDS300</b>
4"	¼"	<b>SDA400</b>	<b>SDS400</b>



### Pull Ring Safety Clips for Boss-Lock™

Coupler Size	Carbon Steel	316 Stainless Steel
	Part #	Part #
¾" - 1"	---	<b>100PRSCSS</b>
1¼" - 2½"	<b>200PRSCCS</b>	<b>200PRSCSS</b>
3" and 4"	<b>300PRSCCS</b>	<b>300PRSCSS</b>



### Pull Rings

304 Stainless Steel Part #
<b>R200SS</b>



### Sash Chain with Pull Rings

**Feature:**

- brass chain, plated steel pull ring

Length	Part #
4½"	<b>J125</b>
6½"	<b>J150</b>
8½"	<b>J300</b>
12¾"	<b>J500</b>



### Abrasion Resistant Inserts

C  
Cam & Groove



400-A-INSERT



400-C-INSERTAL

**Features:**

- extends the life of adapters when transferring proppant to storage tanks
- available for multiple adapter and multiple coupler materials

Description	UHMW Polyethylene Part #
to be used with <b>400-A-AL, 400-A-BR, 400-A-MI, 400-A-SS</b>	<b>400-A-INSERT</b>
to be used with <b>400-C-AL</b>	<b>400-C-INSERTAL</b>
to be used with <b>400-C-MI</b>	<b>400-C-INSERTMI</b>

### Clip for Boss-Lock™ Couplings

C



**Feature:**

- .072 stainless steel wire

Stainless Steel Part #
<b>AC7</b>

### Clip Assembly



**Features:**

- for use with Boss-Lock™ couplings
- includes pull ring, chain and AC3 clip

CarbonSteel Part #
<b>BLCA152CS</b>

### Jack Chain with S-Hook



Length	Material	Part #	Optional Qty
6"	brass	<b>CH-B-6</b>	10
12"	brass	<b>CH-B-12</b>	10
24"	brass	<b>CH-B-24</b>	---
12"	carbon steel	<b>CH-C-12</b>	10
6"	stainless	<b>CH-SS-6</b>	10
12"	stainless	<b>CH-SS-12</b>	10
24"	stainless	<b>CH-SS-24</b>	10

### Locking Cam Arm Velcro® Straps

**Application:**

- use with cam & groove couplers to prevent spills, secure from damage, and hold in place during transport



coupler sold separately

**Features:**

- used on the female end of a cam & groove coupler
- high visibility orange hook and loop with metal buckle provides strength, durability and long life
- temperature range: **-70°F to 200°F (-57°C to 93°C)**

Length	Used On	Part #
12"	fits up to 1½" coupler	<b>CVS12</b>
18"	fits up to 3" coupler	<b>CVS18</b>
24"	fits up to 5" coupler	<b>CVS24</b>
36"	fits up to 8" coupler	<b>CVS36</b>

### Lanyards with Clip for Boss-Lock™ Couplings

**Materials:**

- clip: carbon steel
- lanyard: nylon

Coupler Size	Part #
¾" - 1"	<b>ACL4</b>
1¼" - 4"	<b>ACL2</b>
6"	<b>ACL3</b>



Cam & Groove

### PVC Coated Lanyards

**Material:**

- PVC coated carbon steel with aluminum crimp sleeves

**Feature:**

- one end factory crimped, one end uncrimped for field installation

Length	Part #
15"	<b>CAL15</b>
25"	<b>CAL25</b>



### Lanyard for Boss-Lock™ Couplings

**Feature:**

- breaking strength: 160 lbs.

Overall Length	304 Stainless Part #
7"	<b>LR7</b>



Global Type A Adapters  
adapter x female NPT

Cam & Groove

**Features:**

- interchanges with all products produced to A-A-59326D
- pressure rating for adapters is based on the seal of the mating part



ASTMC38000 forged brass

Size	A380 Permanent Mold Aluminum Part #	ASTMC38000 Forged Brass Part #
1/2"	<b>G50-A-AL</b> <sup>1</sup>	<b>G50-A-BR</b> <sup>1</sup>
3/4"	<b>G75-A-AL</b>	<b>G75-A-BR</b>
1"	<b>G100-A-AL</b>	<b>G100-A-BR</b>
1 1/4"	<b>G125-A-AL</b>	<b>G125-A-BR</b>
1 1/2"	<b>G150-A-AL</b>	<b>G150-A-BR</b>
2"	<b>G200-A-AL</b>	<b>G200-A-BR</b>
2 1/2"	<b>G250-A-AL</b>	<b>G250-A-BR</b>
3"	<b>G300-A-AL</b>	<b>G300-A-BR</b>
4"	<b>G400-A-AL</b>	<b>G400-A-BR</b>
5"	<b>G500-A-AL</b> <sup>1</sup>	<b>G500-A-BR</b> <sup>1</sup>
6"	<b>G600-A-AL</b>	---
8"	<b>G800-A-AL</b> <sup>1</sup>	---

Size	316 Investment Cast Stainless Steel Part #
1/2"	<b>G50-A-SS</b> <sup>1</sup>
3/4"	<b>G75-A-SS</b>
1"	<b>G100-A-SS</b>
1 1/4"	<b>G125-A-SS</b>
1 1/2"	<b>G150-A-SS</b>
2"	<b>G200-A-SS</b>
2 1/2"	<b>G250-A-SS</b>
3"	<b>G300-A-SS</b>
4"	<b>G400-A-SS</b>
6"	<b>G600-A-SS</b>

<sup>1</sup> No standard exists for the 1/2", 5" and 8", and generally these sizes do not interchange with other manufacturers.



Global Type B Couplers  
coupler x male NPT

Features:

- interchanges with all products produced to A-A-59326D
- Buna seals standard

Size	A380 Permanent Mold A with Brass Handles Part #	ASTMC38000 Forged Brass Part #
1/2"	<b>G50-B-AL</b> <sup>1,2</sup>	<b>G50-B-BR</b> <sup>1,2</sup>
3/4"	<b>G75-B-AL</b> <sup>2</sup>	<b>G75-B-BR</b> <sup>2</sup>
1"	<b>G100-B-AL</b> <sup>2</sup>	<b>G100-B-BR</b> <sup>2</sup>
1 1/4"	<b>G125-B-AL</b>	<b>G125-B-BR</b>
1 1/2"	<b>G150-B-AL</b>	<b>G150-B-BR</b>
2"	<b>G200-B-AL</b>	<b>G200-B-BR</b>
2 1/2"	<b>G250-B-AL</b>	<b>G250-B-BR</b>
3"	<b>G300-B-AL</b>	<b>G300-B-BR</b>
4"	<b>G400-B-AL</b>	<b>G400-B-BR</b>
5"	<b>G500-B-AL</b> <sup>1</sup>	<b>G500-B-BR</b> <sup>1</sup>
6"	<b>G600-B-AL</b>	---

Size	316 Investment Cast Stainless Steel Part #	A380 Permanent Mold Aluminum with Investment Stainless Handles Part #
1/2"	<b>G50-B-SS</b> <sup>1</sup>	---
3/4"	<b>G75-B-SS</b>	---
1"	<b>G100-B-SS</b>	---
1 1/4"	<b>G125-B-SS</b>	---
1 1/2"	<b>G150-B-SS</b>	<b>G150-B-ALSI</b>
2"	<b>G200-B-SS</b>	<b>G200-B-ALSI</b>
2 1/2"	<b>G250-B-SS</b>	---
3"	<b>G300-B-SS</b>	<b>G300-B-ALSI</b>
4"	<b>G400-B-SS</b>	<b>G400-B-ALSI</b>
6"	<b>G600-B-SS</b>	---



A380 permanent mold aluminum

<sup>1</sup> No standard exists for the 1/2", 5" and 8", and generally these sizes do not interchange with other manufacturers.

<sup>2</sup> supplied with stainless steel handles

Global Type C Couplers  
coupler x hose shank

Cam & Groove



A380 permanent mold aluminum

**Features:**

- interchanges with all products produced to A-A-59326D
- Buna seals are standard

Size	A380 Permanent Mold Aluminum with Brass Handles Part #	ASTMC38000 Forged Brass Part #
1/2"	<b>G50-C-AL</b> <sup>1,2</sup>	<b>G50-C-BR</b> <sup>1,2</sup>
3/4"	<b>G75-C-AL</b> <sup>2</sup>	<b>G75-C-BR</b> <sup>2</sup>
1"	<b>G100-C-AL</b> <sup>2</sup>	<b>G100-C-BR</b> <sup>2</sup>
1 1/4"	<b>G125-C-AL</b>	<b>G125-C-BR</b>
1 1/2"	<b>G150-C-AL</b>	<b>G150-C-BR</b>
2"	<b>G200-C-AL</b>	<b>G200-C-BR</b>
2 1/2"	<b>G250-C-AL</b>	<b>G250-C-BR</b>
3"	<b>G300-C-AL</b>	<b>G300-C-BR</b>
4"	<b>G400-C-AL</b>	<b>G400-C-BR</b>
5"	<b>G500-C-AL</b> <sup>1</sup>	<b>G500-C-BR</b> <sup>1</sup>
6"	<b>G600-C-AL</b>	---
8"	<b>G800-C-AL</b> <sup>1</sup>	---

Size	316 Investment Cast Stainless Steel Part #	A380 Permanent Mold Aluminum with Investment Stainless Handles Part #
1/2"	<b>G50-C-SS</b> <sup>1</sup>	---
3/4"	<b>G75-C-SS</b>	---
1"	<b>G100-C-SS</b>	---
1 1/4"	<b>G125-C-SS</b>	---
1 1/2"	<b>G150-C-SS</b>	<b>G150-C-ALSI</b>
2"	<b>G200-C-SS</b>	<b>G200-C-ALSI</b>
2 1/2"	<b>G250-C-SS</b>	---
3"	<b>G300-C-SS</b>	<b>G300-C-ALSI</b>
4"	<b>G400-C-SS</b>	<b>G400-C-ALSI</b>
6"	<b>G600-C-SS</b>	---

<sup>1</sup> No standard exists for the 1/2", 5" and 8", and generally these sizes do not interchange with other manufacturers.

<sup>2</sup> supplied with stainless steel handles

• see page 109 for Global Crimp Type C couplers

## Global Type D Couplers coupler x female NPT

**Features:**

- interchanges with all products produced to A-A-59326D
- Buna seals are standard

Size	A380 Permanent Mold Aluminum with Brass Handles Part #	ASTMC38000 Forged Brass Part #
½"	<b>G50-D-AL</b> <sup>1,2</sup>	<b>G50-D-BR</b> <sup>1,2</sup>
¾"	<b>G75-D-AL</b> <sup>2</sup>	<b>G75-D-BR</b> <sup>2</sup>
1"	<b>G100-D-AL</b> <sup>2</sup>	<b>G100-D-BR</b> <sup>2</sup>
1¼"	<b>G125-D-AL</b>	<b>G125-D-BR</b>
1½"	<b>G150-D-AL</b>	<b>G150-D-BR</b>
2"	<b>G200-D-AL</b>	<b>G200-D-BR</b>
2½"	<b>G250-D-AL</b>	<b>G250-D-BR</b>
3"	<b>G300-D-AL</b>	<b>G300-D-BR</b>
4"	<b>G400-D-AL</b>	<b>G400-D-BR</b>
5"	<b>G500-D-AL</b> <sup>1</sup>	<b>G500-D-BR</b> <sup>1</sup>
6"	<b>G600-D-AL</b>	---

Size	316 Investment Cast Stainless Steel Part #	A380 Permanent Mold Aluminum with Investment Stainless Handles Part #
½"	<b>G50-D-SS</b> <sup>1</sup>	---
¾"	<b>G75-D-SS</b>	---
1"	<b>G100-D-SS</b>	---
1¼"	<b>G125-D-SS</b>	---
1½"	<b>G150-D-SS</b>	<b>G150-D-ALSI</b>
2"	<b>G200-D-SS</b>	<b>G200-D-ALSI</b>
2½"	<b>G250-D-SS</b>	---
3"	<b>G300-D-SS</b>	<b>G300-D-ALSI</b>
4"	<b>G400-D-SS</b>	<b>G400-D-ALSI</b>
6"	<b>G600-D-SS</b>	---

<sup>1</sup> No standard exists for the ½" and 5", and generally these sizes do not interchange with other manufacturers.

<sup>2</sup> stainless steel handles



316 investment cast stainless steel

Global Type E Adapters  
adapter x hose shank

Cam & Groove



A380 permanent mold aluminum

Features:

- interchanges with all products produced to A-A-59326D
- pressure rating for adapters is based on the seal of the mating part

Size	A380 Permanent Mold Aluminum Part #	ASTMC38000 Forged Brass Part #	316 Investment Cast Stainless Steel Part #
1/2"	<b>G50-E-AL</b> <sup>1</sup>	<b>G50-E-BR</b> <sup>1</sup>	<b>G50-E-SS</b> <sup>1</sup>
3/4"	<b>G75-E-AL</b>	<b>G75-E-BR</b>	<b>G75-E-SS</b>
1"	<b>G100-E-AL</b>	<b>G100-E-BR</b>	<b>G100-E-SS</b>
1 1/4"	<b>G125-E-AL</b>	<b>G125-E-BR</b>	<b>G125-E-SS</b>
1 1/2"	<b>G150-E-AL</b>	<b>G150-E-BR</b>	<b>G150-E-SS</b>
2"	<b>G200-E-AL</b>	<b>G200-E-BR</b>	<b>G200-E-SS</b>
2 1/2"	<b>G250-E-AL</b>	<b>G250-E-BR</b>	<b>G250-E-SS</b>
3"	<b>G300-E-AL</b>	<b>G300-E-BR</b>	<b>G300-E-SS</b>
4"	<b>G400-E-AL</b>	<b>G400-E-BR</b>	<b>G400-E-SS</b>
5"	<b>G500-E-AL</b> <sup>1</sup>	<b>G500-E-BR</b> <sup>1</sup>	---
6"	<b>G600-E-AL</b>	---	<b>G600-E-SS</b>
8"	<b>G800-E-AL</b> <sup>1</sup>	---	---

<sup>1</sup> No standard exists for the 1/2", 5" and 8", and generally these sizes do not interchange with other manufacturers.

Global Type F Adapters  
adapter x male NPT

Features:

- interchanges with all products produced to A-A-59326D
- pressure rating for adapters is based on the seal of the mating part



ASTMC38000 forged brass

Size	A380 Permanent Mold Aluminum Part #	ASTMC38000 Forged Brass Part #	316 Investment Cast Stainless Steel Part #
1/2"	<b>G50-F-AL</b> <sup>1</sup>	<b>G50-F-BR</b> <sup>1</sup>	<b>G50-F-SS</b> <sup>1</sup>
3/4"	<b>G75-F-AL</b>	<b>G75-F-BR</b>	<b>G75-F-SS</b>
1"	<b>G100-F-AL</b>	<b>G100-F-BR</b>	<b>G100-F-SS</b>
1 1/4"	<b>G125-F-AL</b>	<b>G125-F-BR</b>	<b>G125-F-SS</b>
1 1/2"	<b>G150-F-AL</b>	<b>G150-F-BR</b>	<b>G150-F-SS</b>
2"	<b>G200-F-AL</b>	<b>G200-F-BR</b>	<b>G200-F-SS</b>
2 1/2"	<b>G250-F-AL</b>	<b>G250-F-BR</b>	<b>G250-F-SS</b>
3"	<b>G300-F-AL</b>	<b>G300-F-BR</b>	<b>G300-F-SS</b>
4"	<b>G400-F-AL</b>	<b>G400-F-BR</b>	<b>G400-F-SS</b>
5"	<b>G500-F-AL</b> <sup>1</sup>	<b>G500-F-BR</b> <sup>1</sup>	---
6"	<b>G600-F-AL</b>	---	<b>G600-F-SS</b>

<sup>1</sup> No standard exists for the 1/2" and 8", and generally these sizes do not interchange with other manufacturers.

Global Type DC Dust Caps

Features:

- interchanges with all products produced to A-A-59326D
- Buna seals are standard
- *Dust caps and dust plugs are not to be used in pressure applications for safety and environmental reasons*



Size	A380 Permanent Mold Aluminum with Brass Handles Part #	ASTMC38000 Forged Brass Part #
1/2"	<b>G50-DC-AL</b> <sup>1,2</sup>	<b>G50-DC-BR</b> <sup>1,2</sup>
3/4"	<b>G75-DC-AL</b> <sup>2</sup>	<b>G75-DC-BR</b> <sup>2</sup>
1"	<b>G100-DC-AL</b> <sup>2</sup>	<b>G100-DC-BR</b> <sup>2</sup>
1 1/4"	<b>G125-DC-AL</b>	<b>G125-DC-BR</b>
1 1/2"	<b>G150-DC-AL</b>	<b>G150-DC-BR</b>
2"	<b>G200-DC-AL</b>	<b>G200-DC-BR</b>
2 1/2"	<b>G250-DC-AL</b>	<b>G250-DC-BR</b>
3"	<b>G300-DC-AL</b>	<b>G300-DC-BR</b>
4"	<b>G400-DC-AL</b>	<b>G400-DC-BR</b>
5"	<b>G500-DC-AL</b> <sup>1</sup>	<b>G500-DC-BR</b> <sup>1</sup>
6"	<b>G600-DC-AL</b>	---

Size	316 Investment Cast Stainless Steel Part #	A380 Permanent Mold Aluminum with Investment Stainless Handles Part #
1/2"	<b>G50-DC-SS</b> <sup>1</sup>	---
3/4"	<b>G75-DC-SS</b>	---
1"	<b>G100-DC-SS</b>	---
1 1/4"	<b>G125-DC-SS</b>	---
1 1/2"	<b>G150-DC-SS</b>	<b>G150-DC-ALSI</b>
2"	<b>G200-DC-SS</b>	<b>G200-DC-ALSI</b>
2 1/2"	<b>G250-DC-SS</b>	---
3"	<b>G300-DC-SS</b>	<b>G300-DC-ALSI</b>
4"	<b>G400-DC-SS</b>	<b>G400-DC-ALSI</b>
6"	<b>G600-DC-SS</b>	---



A380 permanent mold aluminum

<sup>1</sup> No standard exists for the 1/2" and 5", and generally these sizes do not interchange with other manufacturers.

<sup>2</sup> stainless steel handles

Global Type DP Dust Plugs

Features:

- interchanges with all products produced to A-A-59326D
- Buna seals are standard
- *Dust caps and dust plugs are not to be used in pressure applications for safety and environmental reasons*



Size	A380 Permanent Mold Aluminum Part #	ASTMC38000 Forged Brass Part #	316 Investment Cast Stainless Steel Part #
1/2"	<b>G50-DP-AL</b> <sup>1</sup>	<b>G50-DP-BR</b> <sup>1</sup>	<b>G50-DP-SS</b> <sup>1</sup>
3/4"	<b>G75-DP-AL</b>	<b>G75-DP-BR</b>	<b>G75-DP-SS</b>
1"	<b>G100-DP-AL</b>	<b>G100-DP-BR</b>	<b>G100-DP-SS</b>
1 1/4"	<b>G125-DP-AL</b>	<b>G125-DP-BR</b>	<b>G125-DP-SS</b>
1 1/2"	<b>G150-DP-AL</b>	<b>G150-DP-BR</b>	<b>G150-DP-SS</b>
2"	<b>G200-DP-AL</b>	<b>G200-DP-BR</b>	<b>G200-DP-SS</b>
2 1/2"	<b>G250-DP-AL</b>	<b>G250-DP-BR</b>	<b>G250-DP-SS</b>
3"	<b>G300-DP-AL</b>	<b>G300-DP-BR</b>	<b>G300-DP-SS</b>
4"	<b>G400-DP-AL</b>	<b>G400-DP-BR</b>	<b>G400-DP-SS</b>
5"	<b>G500-DP-AL</b> <sup>1</sup>	<b>G500-DP-BR</b> <sup>1</sup>	---
6"	<b>G600-DP-AL</b>	---	<b>G600-DP-SS</b>



A380 permanent mold aluminum

<sup>1</sup> No standard exists for the 1/2" and 5", and generally these sizes do not interchange with other manufacturers.

## Global Type DA Jump Size Couplings coupler x adapter

Cam &amp; Groove



A380 permanent mold aluminum

**Features:**

- interchanges with all products produced to A-A-59326D
- Buna seals standard
- pressure rating for adapters is based on the seal of the mating part

Size	A380 Permanent Mold Aluminum Part #	316 Investment Cast Stainless Steel Part #
2" x 3"	<b>G2030-DA-AL</b>	---
3" x 2"	<b>G3020-DA-AL</b>	<b>G3020-DA-SS</b>
3" x 4"	<b>G3040-DA-AL</b>	---
4" x 3"	<b>G4030-DA-AL</b>	<b>G4030-DA-SS</b>
5" x 4"	<b>G5040-DA-AL</b>	---
6" X 4"	<b>G6040-DA-AL</b>	---

## Global Type AA Spool Adapters adapter x adapter



A380 permanent mold aluminum



A380 permanent mold aluminum

**Features:**

- interchanges with all products produced to A-A-59326D
- pressure rating for adapters is based on the seal of the mating part

Size	A380 Permanent Mold Aluminum Part #	316 Investment Cast Stainless Steel Part #
1"	<b>G100-AA-AL</b>	---
1½"	<b>G150-AA-AL</b>	<b>G150-AA-SS</b>
1½" x 2"	<b>G1520-AA-AL</b>	---
2"	<b>G200-AA-AL</b>	<b>G200-AA-SS</b>
2" x 3"	<b>G2030-AA-AL</b>	<b>G2030-AA-SS</b>
3"	<b>G300-AA-AL</b>	<b>G300-AA-SS</b>
3" x 4"	<b>G3040-AA-AL</b>	---
4"	<b>G400-AA-AL</b>	<b>G400-AA-SS</b>

## Global Type DD Couplers coupler x coupler



A380 permanent mold aluminum

**Features:**

- interchanges with all products produced to A-A-59326D
- Buna seals standard

Size	A380 Permanent Mold Aluminum Part #	316 Investment Cast Stainless Steel Part #
2"	<b>G200-DD-AL</b>	<b>G200-DD-SS</b>
3"	<b>G300-DD-AL</b>	<b>G300-DD-SS</b>
4"	<b>G400-DD-AL</b>	<b>G400-DD-SS</b>

Global Type A Jump Size Adapters  
adapter x female NPT

Features:

- interchanges with all products produced to A-A-59326D
- pressure rating for adapters is based on the seal of the mating part

Size	A380 Permanent Mold Aluminum Part #
3" x 2"	<b>G3020-A-AL</b>
4" x 3"	<b>G4030-A-AL</b>



Cam & Groove

Global Type C Jump Size Couplers  
coupler x hose shank

Features:

- interchanges with all products produced to A-A-59326D
- Buna seals standard

Size	A380 Permanent Mold Aluminum Part #
3" x 2"	<b>G3020-C-AL</b>
4" x 3"	<b>G4030-C-AL</b>



C

Global Type E Jump Size Adapters  
adapter x hose shank

Features:

- interchanges with all products produced to A-A-59326D
- pressure rating for adapters is based on the seal of the mating part

Size	A380 Permanent Mold Aluminum Part #
3" x 2"	<b>G3020-E-AL</b>
4" x 3"	<b>G4030-E-AL</b>



- see page110 for Global Crimp Type E adapters

Global Adapter x TTMA Flange

Features:

- interchange with all products produced to A-A-59326D
- Buna seals are standard
- pressure rating for adapters is based on the seal of the mating part

Size	356T6 Aluminum Part #
4"	<b>G400-ALT-AL</b>



Global Coupler x TTMA Flange

Size	356T6 Aluminum Part #
4"	<b>G400-DLT-AL</b>



- For flange dimensions, diagrams and additional information please reference [dixonvalve.com](http://dixonvalve.com).

C

Cam & Groove



Global Adapter x ANSI Flange

Size	Aluminum Part #
4"	<b>G400-AL-AL</b>
6"	<b>G600-AL-AL</b>



Global Coupler x ANSI Flange

Size	Aluminum Part #
4"	<b>G400-DL-AL</b>
6"	<b>G600-DL-AL</b>

C

Handles for Aluminum / Brass Global Couplers

Feature:

- supplied complete with ring and pin



Fits on sizes	Investment Stainless Part #
½", ¾" 1"	<b>G75HRP</b> <b>G100HRP</b>
1½" & 2" 3" - 5" 6"	<b>G152HRPSI</b> <b>G34HRPSI</b> <b>G600HRPSI</b>



Fits on sizes	Forged Brass Part #
1¼" - 2½" 3" - 5" 6" and 8"	<b>G152HRP</b> <b>G34HRP</b> <b>G600HRP</b>

- Global Dixon handle assemblies are to only be used with global Dixon parts (not domestic). Handles do not interchange with other manufacturer's handles or couplers. 

Handles for Stainless Global Couplers

Feature:

- supplied complete with ring and pin



Fits on sizes	Investment Stainless Part #
½", ¾" 1"	<b>G75HRPSS</b> <b>G100HRPSS</b>
1¼" - 2½" 3" - 5" 6"	<b>G125250HRPSS</b> <b>G300400HRPSS</b> <b>G600HRPSS</b>

- Global Dixon handle assemblies are to only be used with global Dixon parts (not domestic). Handles do not interchange with other manufacturer's handles or couplers. 

Safety Clip for Global Couplers



Zinc Plated Carbon Steel Part #	Bag Qty
<b>GSAFETYCLIP</b>	25



Cam and Groove x NST

**Features:**

- powder coated aluminum adapter
- for suction and low pressure discharge only
- other sizes, configurations and materials available, contact Dixon® for information

**Type A x Female NST (NH)**

Adapter Size	Female NST (NH) Thread	Aluminum Part #
1½"	1½"	<b>G150-A-ALNST</b>
2½"	2½"	<b>G250-A-ALNST</b>
3"	2½"	<b>3025-A-ALNST</b>



**Type B x Male NST (NH)**

**Feature:**

- Buna seals standard

Coupler Size	Male NST (NH) Thread	Aluminum Part #
1½"	1½"	<b>G150-B-ALNST</b>
2"	1½"	<b>2015-B-ALNST</b>
2½"	2½"	<b>G250-B-ALNST</b>
3"	2½"	<b>3025-B-ALNST</b>



**Type D x Female NST (NH)**

**Feature:**

- Buna seals standard

Coupler Size	Female NST (NH) Thread	Aluminum Part #
1½"	1½"	<b>G150-D-ALNST</b>
2"	2½"	<b>2025-D-ALNST</b>
2½"	2½"	<b>G250-D-ALNST</b>
3"	2½"	<b>3025-D-ALNST</b>



**Type F x Male NST (NH)**

Adapter Size	Male NST (NH) Thread	Aluminum Part #
1½"	1½"	<b>G150-F-ALNST</b>
2"	2½"	<b>2025-F-ALNST</b>
2½"	2½"	<b>G250-F-ALNST</b>
3"	2½"	<b>3025-F-ALNST</b>



### Type A Adapters adapter x female NPT

**Features:**

- maximum operating pressure: **125 PSI** (½" - 1"), **100 PSI** (1¼" - 2"), **60 PSI** (3") and **50 PSI** (4"); recommendations based on the use of mating Dixon® fittings at an ambient temperature of **70°F (21°C)** with standard seal installed
- ½" couplers and adapters will interchange with ¾" couplers and adapters, only the threads and barbs are ½"
- 1¼" couplers and adapters will interchange with 1½" couplers and adapters, only the threads and barbs are 1¼"
- NOT recommended for use with PTFE gaskets. NOT recommended for use with PTFE gaskets. Polypropylene cam & groove should not be mixed with metal fittings. 



Size	Glass-Filled Polypropylene Part #	Optional Qty
¾" x ½"	<b>PPA50</b>	24
¾"	<b>PPA75</b>	24
1"	<b>PPA100</b>	24
1½" x 1¼"	<b>PPA125</b>	24
1½"	<b>PPA150</b>	24
2"	<b>PPA200</b>	24
3"	<b>PPA300</b>	24
4"	<b>PPA400</b>	8

### Type B Couplers coupler x male NPT

**Features:**

- supplied with EPDM gaskets, 304 stainless steel handles and pins
- maximum operating pressure: **125 PSI** (½" - 1"), **100 PSI** (1¼" - 2"), **60 PSI** (3") and **50 PSI** (4"); recommendations based on the use of mating Dixon® fittings at an ambient temperature of **70°F (21°C)** with standard seal installed
- ½" couplers and adapters will interchange with ¾" couplers and adapters, only the threads and barbs are ½"
- 1¼" couplers and adapters will interchange with 1½" couplers and adapters, only the threads and barbs are 1¼"
- replacements: gasket use EPR on page 168, key rings use **R200SS** on page 171, safety clip use **GSAFETYCLIP** on page 182
- NOT recommended for use with PTFE gaskets. Polypropylene cam & groove should not be mixed with metal fittings. 



Size	Glass-Filled Polypropylene Part #	Optional Qty
¾" x ½"	<b>PPB50</b>	24
¾"	<b>PPB75</b>	24
1"	<b>PPB100</b>	24
1½" x 1¼"	<b>PPB125</b>	24
1½"	<b>PPB150</b>	24
2"	<b>PPB200</b>	24
3"	<b>PPB300</b>	24
4"	<b>PPB400<sup>1</sup></b>	8

<sup>1</sup> 4" coupler has 4 handles

### Type C Couplers coupler x hose shank

**Features:**

- supplied with EPDM gaskets, 304 stainless steel handles and pins
- maximum operating pressure: **125 PSI** (½" - 1"), **100 PSI** (1¼" - 2"), **60 PSI** (3") and **50 PSI** (4"); recommendations based on the use of mating Dixon® fittings at an ambient temperature of **70°F (21°C)** with standard seal installed
- ½" couplers and adapters will interchange with ¾" couplers and adapters, only the threads and barbs are ½"
- 1¼" couplers and adapters will interchange with 1½" couplers and adapters, only the threads and barbs are 1¼"
- replacements: gasket use **EPR** on page 168, pull rings use **R200SS** on page 171, safety clip use **GSAFETYCLIP** on page 182
- NOT recommended for use with PTFE gaskets. Polypropylene cam and groove should not be mixed with metal fittings. 



Size	Glass-Filled Polypropylene Part #	Optional Qty
¾" x ½"	<b>PPC50</b>	24
¾"	<b>PPC75</b>	24
1"	<b>PPC100</b>	24
1½" x 1¼"	<b>PPC125</b>	24
1½"	<b>PPC150</b>	24
2"	<b>PPC200</b>	24
3"	<b>PPC300</b>	24
4"	<b>PPC400</b> <sup>1</sup>	8

<sup>1</sup> 4" coupler has 4 handles

### Type D Couplers coupler x female NPT

**Features:**

- supplied with EPDM gaskets, 304 stainless steel handles and pins
- maximum operating pressure: **125 PSI** (½" - 1"), **100 PSI** (1¼" - 2"), **60 PSI** (3") and **50 PSI** (4"); recommendations based on the use of mating Dixon® fittings at an ambient temperature of **70°F (21°C)** with standard seal installed
- ½" couplers and adapters will interchange with ¾" couplers and adapters, only the threads and barbs are ½"
- 1¼" couplers and adapters will interchange with 1½" couplers and adapters, only the threads and barbs are 1¼"
- replacements: gasket use **EPR** on page 168, pull rings use **R200SS** on page 171, safety clip use **GSAFETYCLIP** on page 182
- NOT recommended for use with PTFE gaskets. Polypropylene cam and groove should not be mixed with metal fittings. 



Size	Glass-Filled Polypropylene Part #	Optional Qty
¾" x ½"	<b>PPD50</b>	24
¾"	<b>PPD75</b>	24
1"	<b>PPD100</b>	24
1½" x 1¼"	<b>PPD125</b>	24
1½"	<b>PPD150</b>	24
2"	<b>PPD200</b>	24
3"	<b>PPD300</b>	24
4"	<b>PPD400</b> <sup>1</sup>	8

<sup>1</sup> 4" coupler has 4 handles

### Type E Adapters adapter x hose shank

**Features:**

- maximum operating pressure: **125 PSI** (½" - 1"), **100 PSI** (1¼" - 2"), **60 PSI** (3") and **50 PSI** (4"); recommendations based on the use of mating Dixon® fittings at an ambient temperature of **70°F (21°C)** with standard seal installed
- ½" couplers and adapters will interchange with ¾" couplers and adapters, only the threads and barbs are ½"
- 1¼" couplers and adapters will interchange with 1½" couplers and adapters, only the threads and barbs are 1¼"
- NOT recommended for use with PTFE gaskets. Polypropylene cam & groove should not be mixed with metal fittings. 



Size	Glass-Filled Polypropylene Part #	Optional Qty
¾" x ½"	<b>PPE50</b>	24
¾"	<b>PPE75</b>	24
1"	<b>PPE100</b>	24
1½" x 1¼"	<b>PPE125</b>	24
1½"	<b>PPE150</b>	24
2"	<b>PPE200</b>	24
3"	<b>PPE300</b>	24
4"	<b>PPE400</b>	8

### Type F Adapters adapter x male NPT

**Features:**

- maximum operating pressure: **125 PSI** (½" - 1"), **100 PSI** (1¼" - 2"), **60 PSI** (3") and **50 PSI** (4"); recommendations based on the use of mating Dixon® fittings at an ambient temperature of **70°F (21°C)** with standard seal installed
- ½" couplers and adapters will interchange with ¾" couplers and adapters, only the threads and barbs are ½"
- 1¼" couplers and adapters will interchange with 1½" couplers and adapters, only the threads and barbs are 1¼"
- NOT recommended for use with PTFE gaskets. Polypropylene cam & groove should not be mixed with metal fittings. 



Size	Glass-Filled Polypropylene Part #	Optional Qty
¾" x ½"	<b>PPF50</b>	24
¾"	<b>PPF75</b>	24
1"	<b>PPF100</b>	24
1½" x 1¼"	<b>PPF125</b>	24
1½"	<b>PPF150</b>	24
2"	<b>PPF200</b>	24
3"	<b>PPF300</b>	24
4"	<b>PPF400</b>	8

## Dust Caps and Plugs

**Features:**

- Dust caps and dust plugs are not to be used in pressure applications for safety and environmental reasons.
- NOT recommended for use with PTFE gaskets. Polypropylene cam & groove should not be mixed with metal fittings
- supplied with EPDM gaskets, 304 stainless steel handles and pins
- replacements: gasket use EPR on page 168, key rings use **R200SS** on page 171, safety clip use **GSAFETYCLIP** on page 182

### Type H Dust Caps

Size	Glass-Filled Polypropylene Part #	Optional Qty
¾"	<b>PPH75</b>	24
1"	<b>PPH100</b>	24
1½"	<b>PPH150</b>	24
2"	<b>PPH200</b>	24
3"	<b>PPH300</b>	24
4"	<b>PPH400<sup>1</sup></b>	8

<sup>1</sup> 4" coupler has 4 handles



### Type P Dust Plugs

Size	Glass-Filled Polypropylene Part #	Optional Qty
¾"	<b>PPP75</b>	24
1"	<b>PPP100</b>	24
1½"	<b>PPP150</b>	24
2"	<b>PPP200</b>	24
3"	<b>PPP300</b>	24
4"	<b>PPP400</b>	8



Type A 90° Elbows  
adapter x female NPT

Cam & Groove



Features:

- maximum operating pressure: **100 PSI** (1½" - 2"); recommendations based on the use of mating Dixon® fittings at an ambient temperature of **70°F (21°C)** with standard seal installed
- for use at elevated temperatures or other unusual operating conditions, consult Dixon®
- NOT recommended for use with PTFE gaskets. NOT recommended for use with PTFE gaskets. Polypropylene cam & groove should not be mixed with metal fittings. 

Size	Glass-Filled Polypropylene Part #	Optional Qty
1½"	<b>90PPA150</b>	24
2"	<b>90PPA200</b>	24

Type C 90° Elbows  
coupler x hose shank



Features:

- supplied with EPDM gaskets, 304 stainless steel handles and pins
- maximum operating pressure: **100 PSI** (1½" - 2"); recommendations based on the use of mating Dixon® fittings at an ambient temperature of **70°F (21°C)** with standard seal installed
- for use at elevated temperatures or other unusual operating conditions, consult Dixon®
- NOT recommended for use with PTFE gaskets. Polypropylene cam and groove should not be mixed with metal fittings. 

Size	Glass-Filled Polypropylene Part #	Optional Qty
1½"	<b>90PPC150</b>	24
2"	<b>90PPC200</b>	24

Type D 90° Elbows  
coupler x female NPT



Features:

- supplied with EPDM gaskets, 304 stainless steel handles and pins
- maximum operating pressure: **100 PSI** (1½" - 2"); recommendations based on the use of mating Dixon® fittings at an ambient temperature of **70°F (21°C)** with standard seal installed
- for use at elevated temperatures or other unusual operating conditions, consult Dixon®
- NOT recommended for use with PTFE gaskets. Polypropylene cam and groove should not be mixed with metal fittings. 

Size	Glass-Filled Polypropylene Part #	Optional Qty
1½"	<b>90PPD150</b>	24
2"	<b>90PPD200</b>	24

Type F 90° Elbows  
adapter x male NPT



Features:

- maximum operating pressure: **100 PSI** (1½" - 2"); recommendations based on the use of mating Dixon® fittings at an ambient temperature of **70°F (21°C)** with standard seal installed
- for use at elevated temperatures or other unusual operating conditions, consult Dixon®
- NOT recommended for use with PTFE gaskets. Polypropylene cam & groove should not be mixed with metal fittings. 

Size	Glass-Filled Polypropylene Part #	Optional Qty
1½"	<b>90PPF150</b>	24
2"	<b>90PPF200</b>	24

<b>King™ Combination Nipples</b> .....	190 to 195	<b>Garden Hose Fittings</b> .....	234 to 245
NPT threaded .....	190	Standard shanks.....	234, 236
Beveled end.....	191	Short shanks.....	235 to 236
Grooved end.....	191	Menders.....	236
BSPT end .....	191	Long shank.....	237
Jump size NPT threaded.....	192	Spray hose .....	234
For Plastic pipe NPT threaded .....	192	GHT zinc.....	239
Global NPT threaded.....	192	GHT adapters .....	239 to 241
150# ASA flange.....	193	Washers .....	242
Turned back.....	193	Caps .....	242
Notched turned back .....	194	Nuts .....	242
Notched ferrules .....	194	Compression bibb faucet.....	243
PF shank .....	195	Quick connect assembly.....	243
External swage notched .....	195	Valves .....	244
External swage ferrules .....	195	Y .....	244
		Manifold.....	245
<b>Short crimp sleeves</b> .....	196	Back flow preventer.....	245
		Radiator bibb .....	245
<b>King Nipples</b> .....	197	Gooseneck .....	245
Steel round .....	197		
Steel hex.....	197	<b>Plastic Barbs &amp; Inserts</b> ....	246 to 252
		Hose shank x male NPT.....	246
<b>Shank Couplings</b> .....	198 to 205	Tuff-Lite™ .....	246 to 252
Suction couplings .....	198 to 199		
Short shank .....	199, 201	<b>Agri-Lock Style Couplings</b> .....	253 to 256
Long shank.....	200, 202, 203	Type A.....	253 to 256
Spanner wrenches.....	200		
Spray hose .....	204	<b>Bauer Style Couplings</b> .....	257 to 261
Gaskets .....	205	Type B .....	257 to 261
<b>Strainers, Skimmers &amp; Foot Valves</b> ..	206 to 208		
Strainers .....	206, 207		
Skimmers.....	207		
Foot valves .....	208		
<b>Hose Barbs &amp; Inserts</b> .....	209 to 233		
Hose menders .....	209 to 210		
Male x hose barbs .....	211 to 212		
Female x hose barbs.....	212 to 213		
Elbows.....	214 to 215		
Splicers.....	215		
SAE / JIC.....	216 to 217		
Ferrules for air & fluid .....	218		
Ferrules for fluid.....	218		
Ribbed and plain dies.....	219		
Crimpers .....	220 to 222		
Crimp dies .....	221 to 222		
Push-on .....	223 to 230		
Reusable .....	231 to 233		

## King™ Combination Nipples

**⚠ WARNING****Applications:**

- Recommended for low-pressure discharge and suction service for compatible liquids.  
**Sizes 1¼" and above are not for compressible products such as air or nitrogen.**
- **King™ Combination Nipples are not recommended for steam.**
- *The working pressure may vary with the construction of the hose, the type of clamping system used and the application. Consult Dixon® for recommendations.*
- In accordance with the Association for Rubber Products Manufacturers (ARPM) bulletin for oil suction and discharge hose, a coupled length of hose in any size, should be tested to 1½ times the working pressure and held for fifteen minutes without leaking or coupling movement. For additional information and detailed instruction on testing procedures, see the Association for Rubber Products Manufacturers (ARPM) handbook.

## NPT Threaded End with Knurled Wrench Grip



Size	Opt Qty	Unplated Steel Part #	Plated Steel Part #	Brass Part #	Aluminum Part #
½"	50	<b>ST1</b>	<b>STC1</b>	<b>BST1</b>	<b>AST1</b>
¾"	50	<b>ST5</b>	<b>STC5</b>	<b>BST5</b>	<b>AST5</b>
1"	50	<b>ST10</b>	<b>STC10</b>	<b>BST10</b>	<b>AST10</b>
1¼"	50	<b>ST15</b>	<b>STC15</b>	---	---
1½"	50	<b>ST20</b>	<b>STC20</b>	---	---
2"	25	<b>ST25</b>	<b>STC25</b>	---	---

- For additional information on pipe dimensions please reference [dixonvalve.com](http://dixonvalve.com).

## NPT Threaded End No Knurl



Size	Opt Qty	Unplated Steel Part #	Plated Steel Part #	Brass Part #	Aluminum Part #
1¼"	50	---	---	<b>BST15</b>	<b>AST15</b>
1½"	50	---	---	<b>BST20</b>	<b>AST20</b>
2"	25	---	---	<b>BST25</b>	<b>AST25</b>
2½"	10	<b>ST30</b>	<b>STC30</b>	<b>BST30</b>	<b>AST30</b>
3"	10	<b>ST35</b>	<b>STC35</b>	<b>BST35</b>	<b>AST35</b>
4"	4	<b>ST40</b>	<b>STC40</b>	<b>BST40</b>	<b>AST40</b>
5"	4	<b>ST50</b>	<b>STC50</b>	---	<b>AST50</b>
6"	2	<b>ST60</b>	<b>STC60</b>	---	<b>AST60</b>
8"	2	<b>ST80</b>	<b>STC80</b>	---	---
10"	1	<b>ST100</b>	<b>STC100</b>	---	---
12"	1	<b>ST120</b>	<b>STC120</b>	---	---



Size	Opt Qty	316 Stainless Steel Part #	Hastelloy® Part #
½"	50	<b>RST1</b> <sup>1</sup>	---
¾"	50	<b>RST5</b> <sup>1</sup>	---
1"	50	<b>RST10</b>	---
1¼"	50	<b>RST15</b>	---
1½"	50	<b>RST20</b>	---
2"	25	<b>RST25</b>	<b>HST25</b>
2½"	10	<b>RST30</b>	---
3"	10	<b>RST35</b>	<b>HST35</b>
4"	4	<b>RST40</b>	---
5"	4	<b>RST50</b>	---
6"	4	<b>RST60</b>	---
8"	2	<b>RST80</b>	---

<sup>1</sup> made from investment casting

- For additional information on pipe dimensions please reference [dixonvalve.com](http://dixonvalve.com).



King™ Combination Nipples  
Beveled End

- Beveled ends (in *brass*) are available in select sizes. Consult Dixon® for prices and availability.

Hose ID	Unplated Steel Part #	Opt Qty	316 Stainless Steel Part #	Opt Qty	Aluminum Part #
1/2"	<b>STB1</b>	50	---	--	---
3/4"	<b>STB5</b>	50	<b>RSTB5</b>	50	---
1"	<b>STB10</b>	50	<b>RSTB10</b>	50	<b>ASTB10</b>
1 1/4"	<b>STB15</b>	50	<b>RSTB15</b>	50	<b>ASTB15</b>
1 1/2"	<b>STB20</b>	50	<b>RSTB20</b>	50	<b>ASTB20</b>
2"	<b>STB25</b>	25	<b>RSTB25</b>	25	<b>ASTB25</b>
2 1/2"	<b>STB30</b>	10	<b>RSTB30</b>	10	<b>ASTB30</b>
3"	<b>STB35</b>	10	<b>RSTB35</b>	10	<b>ASTB35</b>
4"	<b>STB40</b>	4	<b>RSTB40</b>	4	<b>ASTB40</b>
5"	<b>STB50</b>	4	---	--	<b>ASTB50</b>
6"	<b>STB60</b>	2	<b>RSTB60</b>	4	<b>ASTB60</b>
8"	<b>STB80</b>	2	<b>RSTB80</b>	2	<b>ASTB80</b>
10"	<b>STB100</b>	1	---	--	<b>ASTB100</b>
12"	<b>STB120</b>	1	---	--	---



- For additional information on pipe dimensions please reference [dixonvalve.com](http://dixonvalve.com).

King™ Combination Nipples  
Grooved End

- Grooved ends (in *brass* and *aluminum*) are available in select sizes. Consult Dixon® for prices and availability.
- See pages 690 - 702 for our complete line of groove style fittings.

Hose ID	Unplated Steel Part #	Opt Qty	316 Stainless Steel Part #	Opt Qty
1"	<b>STV10</b>	50	---	---
1 1/4"	<b>STV15</b>	50	---	---
1 1/2"	<b>STV20</b>	50	<b>RSTV20</b>	50
2"	<b>STV25</b>	25	<b>RSTV25</b>	25
2 1/2"	<b>STV30</b>	10	---	---
3"	<b>STV35</b>	10	<b>RSTV35</b>	10
4"	<b>STV40</b>	4	<b>RSTV40</b>	5
5"	<b>STV50</b>	4	---	---
6"	<b>STV60</b>	4	---	---
8"	<b>STV80</b>	2	---	---
10"	<b>STV100</b>	1	---	---
12"	<b>STV120</b>	1	---	---



- For additional information on pipe dimensions please reference [dixonvalve.com](http://dixonvalve.com).

King™ Combination Nipples  
BSPT End

Size	Plated Steel Part #	Opt Qty	316 Stainless Steel Part #	Opt Qty
1"	<b>STC10A</b>	50	<b>RST10A</b>	50
1 1/4"	<b>STC15A</b>	50	<b>RST15A</b>	50
1 1/2"	<b>STC20A</b>	50	<b>RST20A</b>	50
2"	<b>STC25A</b>	50	<b>RST25A</b>	25
2 1/2"	<b>STC30A</b>	10	<b>RST30A</b>	10
3"	<b>STC35A</b>	10	<b>RST35A</b>	10
4"	<b>STC40A</b>	4	<b>RST40A</b>	4
6"	<b>STC60A</b>	2	<b>RST60A</b>	2





reducer



increaser

## Jump Size King™ Combination Nipples

### NPT Threaded End

Hose Shank	Male NPT	Plated Steel Part #	316 Stainless Steel Part #
¾"	½"	---	<b>RST0501</b>
	1"	<b>STC0510</b>	<b>RST0510</b>
1"	¾"	<b>STC1005</b>	<b>RST1005</b>
	1¼"	<b>STC1015</b>	<b>RST1015</b>
1¼"	1"	<b>STC1510</b>	<b>RST1510</b>
	1½"	<b>STC1520</b>	<b>RST1520</b>
1½"	1¼"	<b>STC2015</b>	<b>RST2015</b>
	2"	<b>STC2025</b>	<b>RST2025</b>
1¾"	2"	<b>STC175200</b>	---
2"	1½"	<b>STC2520</b>	<b>RST2520</b>
	2½"	<b>STC2530</b>	---
	3"	<b>STC2535</b>	<b>RST2535</b>
2½"	2"	<b>STC3025</b>	---
	3"	<b>STC3035</b>	---
3"	2"	<b>STC3525</b>	<b>RST3525</b>
	2½"	<b>STC3530</b>	---
	4"	<b>STC3540</b>	---
4"	3"	<b>STC4035</b>	---

- For additional information on pipe dimensions please reference [dixonvalve.com](http://dixonvalve.com).

## King™ Combination Nipples for Plastic Pipe

### NPT Threaded End



Size	Plated Steel Part #	Optional Qty
½"	<b>SAP1</b>	50
¾"	<b>SAP6</b>	50
1"	<b>SAP11</b>	50
1¼"	<b>SAP16</b>	50
1½"	<b>SAP21</b>	50
2"	<b>SAP26</b>	25

- For additional information on pipe dimensions please reference [dixonvalve.com](http://dixonvalve.com).

## Global King™ Combination Nipples

### NPT Threaded End

### ⚠ WARNING

#### Features:

- Combination nipples are recommended for low-pressure discharge and suction service for compatible liquids. **Sizes 1¼" and above are not for compressible products such as air or nitrogen.**
- **Global King™ Combination Nipples are not recommended for steam.**
- *The working pressure may vary with the construction of the hose, the type of clamping system used and the application. Consult Dixon® for recommendations.*
- In accordance with the Association for Rubber Products Manufacturers (ARPM) bulletin for oil suction and discharge hose, a coupled length of hose in any size, should be tested to 1½ times the working pressure and held for fifteen minutes without leaking or coupling movement. For additional information and detailed instruction on testing procedures, see the Association for Rubber Products Manufacturers (ARPM) handbook.



Size	Plated Steel Part #	Opt Qty
½"	<b>GSTC1</b>	100
¾"	<b>GSTC5</b>	100
1"	<b>GSTC10</b>	50
1¼"	<b>GSTC15</b>	50
1½"	<b>GSTC20</b>	50
2"	<b>GSTC25</b>	25
2½"	<b>GSTC30</b>	10
3"	<b>GSTC35</b>	10
4"	<b>GSTC40</b>	4
5"	<b>GSTC50</b>	4
6"	<b>GSTC60</b>	4

Flanged King™ Combination Nipples  
150# ASA

Size	Steel Part #	316 Stainless Steel Part #
1½"	<b>FST20</b>	<b>RFST20</b>
2"	<b>FST25</b>	<b>RFST25</b>
3"	<b>FST35</b>	<b>RFST35</b>
4"	<b>FST40</b>	<b>RFST40</b>
6"	<b>FST60</b>	<b>RFST60</b>
8"	<b>FST80</b>	<b>RFST80</b>
10"	<b>FST100</b>	<b>RFST100</b>
12"	<b>FST120</b>	<b>RFST120</b>



Industrial Hose  
Fittings

- For flange dimensions, diagrams and additional information on pipe dimensions please reference dixonvalve.com.

King™ Turned Back Hose Nipples for Floating Flanges

Features:

- A turned back nipple, when used in a floating flange assembly, allows the flange to be aligned without stressing (twisting) the hose. This generally increases the hose's service life by eliminating a common cause of premature hose failure.
- for use with Lap Joint flanges shown on page 688

Size	Plated Carbon Steel Part #	316 Stainless Steel Part #
1"	<b>N10</b>	<b>RN10</b>
1¼"	<b>N15</b>	<b>RN15</b>
1½"	<b>N20</b>	<b>RN20</b>
2"	<b>N25</b>	<b>RN25</b>
2½"	<b>N30</b>	<b>RN30</b>
3"	<b>N35</b>	<b>RN35</b>
4"	<b>N40</b>	<b>RN40</b>
6"	<b>N60</b>	<b>RN60</b>
8"	<b>N80</b>	<b>RN80</b>
10"	<b>N100</b>	<b>RN100</b>
12"	<b>N120</b>	<b>RN120</b>



- For additional information on pipe dimensions please reference dixonvalve.com.

## Notched Turned Back Nipples

**Features:**

- When used with an appropriate notched ferrule, these fittings can be swaged or crimped onto hose providing improved shank retention.
- When used with double bolt or band clamps, notched turn back nipples provide shank retention similar to that of the King™ turned back nipples.
- The stem can be removed from a damaged hose by cutting away the ferrule without necessarily damaging the fitting.
- For use with lap joint flanges on page 688.



## Special pushers required:

1½" stem - RN150NOPUSH

2" stem - RN200NOPUSH

2½" stem - RN250NOPUSH

3" stem - RN300NOPUSH

4" stem - RN400NOPUSH

Size	Carbon Steel Part #	316 Stainless Steel Part #
1½"	<b>N150NO</b>	<b>RN150NO</b>
2"	<b>N200NO</b>	<b>RN200NO</b>
2½"	<b>N250NO</b>	<b>RN250NO</b>
3"	<b>N300NO</b>	<b>RN300NO</b>
4"	<b>N400NO</b>	<b>RN400NO</b>

- For additional information on pipe dimensions please reference [dixonvalve.com](http://dixonvalve.com).

## Notched Ferrules

- reference notched shanks above and adapters on page 143
- Dixon® stems and ferrules are specifically designed to be used together as a coupling system. Due to differences in dimensions and tolerances for safety reasons, do not use other manufacturer's stems or ferrules with Holedall™ products.



Size	Hose OD		304 Stainless Steel Part #
	From	To	
1½"	1-60/64"	2-12/64"	<b>GAS2334NO</b>
	2-4/64"	2-22/64"	<b>GAS2370NO</b>
2"	2-30/64"	2-44/64"	<b>GAS2709NO</b>
	2-42/64"	2-54/64"	<b>GAS2885NO</b>
2½"	2-54/64"	3"	<b>GAS3012NO</b>
	3-1/64"	3-13/64"	<b>GAS3260NO</b>
3"	3-30/64"	3-46/64"	<b>GAS3760NO</b>
	3-47/64"	3-54/64"	<b>GAS3885NO</b>
4"	4-40/64"	4-47/64"	<b>GAS5010NO</b>

PF Shank King™ Combination Nipples

NPT Threaded End

Application:

- This shank design was developed specifically for chemical transport hoses having Crosslinked Polyethylene (XLPE) or Ultra High Molecular Weight Polyethylene (UHMW) tubes, where shank retention can be a problem when using conventional band clamps.

Features:

- PF shank King™ Combination nipples have the same shank pattern as found on the PF style cam and groove fittings sold on page 142.
- recommended for discharge and suction service
- **Not intended for compressed air**
- working pressure is given at 70°F (21°C) maximum
- *The working pressure may vary with the construction of the hose, the type of clamping system used and the application. Consult Dixon® for recommendations.*

Size	Working PSI	Plated Steel Part #	316 Stainless Steel Part #
2"	250	ST25PF	RST25PF
3"	125	ST35PF	RST35PF
4"	100	ST40PF	RST40PF
6"	75	ST60PF	RST60PF

- Beveled ends for welding are also available. Contact Dixon® for further information.
- For additional information on pipe dimensions please reference dixonvalve.com.



External Swage Notched NOS Stems

**⚠ WARNING**

The notched system allows you to better manage your inventories. You can stock one stem and two ferrules, and cover the same hose range with less inventory. *You must purchase a fitting and the matching ferrule to create an assembly.*

Features:

- For hose outside diameters of 2-4/64" and below, *couplings are crimp only.*
- For hose outside diameters of 2-5/64" and above, couplings can be crimped or swaged.
- See page 144 for cam and groove style notched NOS fittings.

**⚠ Only use the NOS shank with the NOS ferrules.** Due to differences in dimensions and tolerances for safety reasons, do not use other manufacturer's stems or ferrules with Dixon® Holedall™ products.



Size	PSI	316 Stainless Steel Part #
1½"	250	RST150NOS
2"	250	RST200NOS
3"	250	RST300NOS
4"	1	RST400NOS

<sup>1</sup> Contact Dixon® for pressure information

Notched NOS Ferrules

- reference notched shanks above and adapters on page 144

Size	Hose OD		304 Stainless Steel Part #
	From	To	
1½"	1-60/64"	2-12/64"	GAS2334NOS
	2-4/64"	2-22/64"	GAS2370NOS
2"	2-30/64"	2-44/64"	GAS2709NOS
	2-42/64"	2-54/64"	GAS2885NOS
3"	3-30/64"	3-46/64"	GAS3760NOS
	3-47/64"	3-54/64"	GAS3885NOS
4"	4-40/64"	4-47/64"	GAS5010NOS



## Short Crimp Sleeves

## Features:

- for use with King™ Combination Nipples only
- a reliable alternative to band clamps
- not for use with Dixon® King Crimp™ Style Shanks



Hose ID	Hose OD		Sleeve ID	Sleeve Wall Thickness	Sleeve Overall Length	Carbon Steel Part #	
	From	To					
¾"	1-5/64"	1-8/64"	1.1875"	.059"	1.25"	<b>CSS075-3CS</b>	
	1-5/64"	1-8/64"	1.1875"	.059"	2.138"	<b>CS075-3CS</b>	
	1-9/64"	1-12/64"	1.250"	.059"	1.25"	<b>CSS075-4CS</b>	
	1-9/64"	1-12/64"	1.250"	.059"	2.138"	<b>CS075-4CS</b>	
	1-17/64"	1-20/64"	1.375"	.059"	1.25"	<b>CSS075-6CS</b>	
	1-17/64"	1-20/64"	1.375"	.059"	2.138"	<b>CS075-6CS</b>	
1"	1-21/64"	1-24/64"	1.438"	.062"	1½"	<b>CSS100-3CS</b>	
	1-25/64"	1-28/64"	1.500"	.062"	1½"	<b>CSS100-4CS</b>	
	1-29/64"	1-32/64"	1.563"	.062"	1½"	<b>CSS100-5CS</b>	
	1-33/64"	1-36/64"	1.625"	.062"	1½"	<b>CSS100-6CS</b>	
	1-37/64"	1-40/64"	1.688"	.062"	1½"	<b>CSS100-7CS</b>	
	1-41/64"	1-44/64"	1.750"	.062"	1½"	<b>CSS100-8CS</b>	
1½"	1-41/64"	1-44/64"	1.750"	.062"	1¾"	<b>CSS150-1CS</b>	
	1-45/64"	1-48/64"	1.813"	.062"	1¾"	<b>CSS150-2CS</b>	
	1-49/64"	1-52/64"	1.875"	.062"	1¾"	<b>CSS150-3CS</b>	
	1-53/64"	1-56/64"	1.938"	.062"	1¾"	<b>CSS150-4CS</b>	
	1-57/64"	1-60/64"	2.000"	.062"	1¾"	<b>CSS150-5CS</b>	
	1-61/64"	2"	2.063"	.062"	1¾"	<b>CSS150-6CS</b>	
	2-1/64"	2-4/64"	2.125"	.062"	1¾"	<b>CSS150-7CS</b>	
	2-5/64"	2-8/64"	2.188"	.062"	1¾"	<b>CSS150-8CS</b>	
	2-9/64"	2-12/64"	2.250"	.062"	1¾"	<b>CSS150-9CS</b>	
2"	2-21/64"	2-24/64"	2.438"	.062"	2"	<b>CSS200-3CS</b>	
	2-25/64"	2-28/64"	2.500"	.062"	2"	<b>CSS200-4CS</b>	
	2-29/64"	2-32/64"	2.563"	.062"	2"	<b>CSS200-5CS</b>	
	2-33/64"	2-36/64"	2.625"	.062"	2"	<b>CSS200-6CS</b>	
	2-37/64"	2-40/64"	2.688"	.062"	2"	<b>CSS200-7CS</b>	
	2-41/64"	2-44/64"	2.750"	.062"	2"	<b>CSS200-8CS</b>	
	2-45/64"	2-48/64"	2.813"	.062"	2"	<b>CSS200-9CS</b>	
	2-49/64"	2-52/64"	2.875"	.062"	2"	<b>CSS200-10CS</b>	
	2-53/64"	2-56/64"	2.938"	.062"	2"	<b>CSS200-11CS</b>	
	2-57/64"	2-60/64"	3.000"	.062"	2"	<b>CSS200-12CS</b>	
	3"	3-13/64"	3-16/64"	3.313"	.090"	2⅝"	<b>CSS300-1CS</b>
		3-17/64"	3-20/64"	3.375"	.090"	2⅝"	<b>CSS300-2CS</b>
3-21/64"		3-24/64"	3.438"	.090"	2⅝"	<b>CSS300-3CS</b>	
3-25/64"		3-28/64"	3.500"	.090"	2⅝"	<b>CSS300-4CS</b>	
3-29/64"		3-32/64"	3.563"	.090"	2⅝"	<b>CSS300-5CS</b>	
3-33/64"		3-36/64"	3.625"	.090"	2⅝"	<b>CSS300-6CS</b>	
3-37/64"		3-40/64"	3.688"	.090"	2⅝"	<b>CSS300-7CS</b>	
3-41/64"		3-44/64"	3.750"	.090"	2⅝"	<b>CSS300-8CS</b>	
3-45/64"		3-48/64"	3.813"	.090"	2⅝"	<b>CSS300-9CS</b>	
3-49/64"		3-52/64"	3.875"	.090"	2⅝"	<b>CSS300-10CS</b>	
3-53/64"		3-56/64"	3.938"	.090"	2⅝"	<b>CSS300-11CS</b>	
3-57/64"		3-60/64"	4.000"	.090"	2⅝"	<b>CSS300-12CS</b>	
4"	4-29/64"	4-32/64"	4.563"	.090"	3-15/32"	<b>CSS400-5CS</b>	
	4-33/64"	4-36/64"	4.625"	.090"	3-15/32"	<b>CSS400-6CS</b>	
	4-37/64"	4-40/64"	4.688"	.090"	3-15/32"	<b>CSS400-7CS</b>	
	4-41/64"	4-44/64"	4.750"	.090"	3-15/32"	<b>CSS400-8CS</b>	
	4-45/64"	4-48/64"	4.813"	.090"	3-15/32"	<b>CSS400-9CS</b>	
	4-49/64"	4-52/64"	4.875"	.090"	3-15/32"	<b>CSS400-10CS</b>	
	4-53/64"	4-56/64"	4.938"	.090"	3-15/32"	<b>CSS400-11CS</b>	
	4-57/64"	4-60/64"	5.000"	.090"	3-15/32"	<b>CSS400-12CS</b>	



### King™ Steel Round Nipples for one clamp

Hose Size	NPT Size	Unplated Steel Part #	Optional Qty
5/8"	1/2"	<b>KRN541</b>	100
3/4"	1/2"	<b>KRN641</b>	50
1"	3/4"	<b>KRN861</b>	25

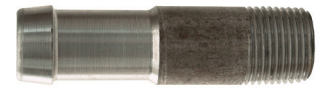

Industrial Hose Fittings

### King™ Steel Round Nipples for two clamps

Hose Size	NPT Size	Unplated Steel Part #	Optional Qty
1/2"	1/4"	<b>KRN422</b>	100
	3/8"	<b>KRN432</b>	100
5/8"	1/2"	<b>KRN542</b>	100
3/4"	1/2"	<b>KRN642</b>	50
	3/4"	<b>KRN662</b>	50
1"	3/4"	<b>KRN862</b>	50
	1"	<b>KRN882</b>	50
1 1/4"	1"	<b>KRN1082</b>	25
1 1/2"	1 1/4"	<b>KRN1210</b>	25
2"	1 1/2"	<b>KRN1612</b>	20



### King™ Steel Hex Nipples for one clamp

Hose Size	NPT Size	Plated Steel Part #	Optional Qty
1/4"	1/4"	<b>KHN221</b>	50
3/8"	1/4"	<b>KHN321</b>	100
	3/8"	<b>KHN331</b>	100
	1/2"	<b>KHN341</b>	100
1/2"	1/4"	<b>KHN421</b>	50
	3/8"	<b>KHN431</b>	50
	1/2"	<b>KHN441</b>	50
	3/4"	<b>KHN461</b>	50
3/4"	1/2"	<b>KHN641</b>	50
	3/4"	<b>KHN661</b>	50
1"	3/4"	<b>KHN861</b>	25
	1"	<b>KHN881</b>	25



### King™ Steel Hex Nipples for two clamps

Hose Size	NPT Size	Plated Steel Part #	Optional Qty
1/4"	1/4"	<b>KHN222</b>	100
3/8"	1/4"	<b>KHN322</b>	100
	3/8"	<b>KHN332</b>	50
	1/2"	<b>KHN342</b>	100
1/2"	1/4"	<b>KHN422</b>	100
	3/8"	<b>KHN432</b>	100
	1/2"	<b>KHN442</b>	50
	3/4"	<b>KHN462</b>	50
3/4"	1/2"	<b>KHN642</b>	50
	3/4"	<b>KHN662</b>	50
1"	3/4"	<b>KHN862</b>	25
	1"	<b>KHN882</b>	25



## King™ Short Shank Suction Hose Couplings NPSM Thread

**Application:**

- for suction or discharge of water

Size	Aluminum shank with Brass nut Complete Part #	Opt Qty	Aluminum shank with Brass nut Female Part #	Aluminum Male Part #
1½"	<b>CAB150</b>	60	<b>FAB150</b>	<b>MA150</b>
2"	<b>CAB200</b>	40	<b>FAB200</b>	<b>MA200</b>
2½"	<b>CAB250</b>	30	<b>FAB250</b>	<b>MA250</b>
3"	<b>CAB300</b>	18	<b>FAB300</b>	<b>MA300</b>
4"	<b>CAB400</b>	8	<b>FAB400</b>	<b>MA400</b>
6"	<b>CAB600</b>	6	<b>FAB600</b>	<b>MA600</b>

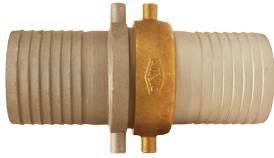

complete



female

1" - 2½"  
male3" - 6"  
male

Size	Brass shank with Brass nut Complete Part #	Brass shank with Brass nut Female Part #	Brass Male Part #
1¼"	<b>CBB125</b>	<b>FBB125</b>	<b>MB125</b>
1½"	<b>CBB150</b>	<b>FBB150</b>	<b>MB150</b>
2"	<b>CBB200</b>	<b>FBB200</b>	<b>MB200</b>
2½"	<b>CBB250</b>	<b>FBB250</b>	<b>MB250</b>
3"	<b>CBB300</b>	<b>FBB300</b>	<b>MB300</b>
4"	<b>CBB400</b>	<b>FBB400</b>	<b>MB400</b>

Size	Plated Iron shank with Plated Iron nut Complete Part #	Plated Iron shank with Plated Iron nut Female Part #	Plated Iron Male Part #
1"	<b>S33</b> <sup>1</sup>	<b>S12</b> <sup>1</sup>	<b>S10</b>
1¼"	<b>S48</b>	<b>S17</b>	<b>S15</b>
1½"	<b>S63</b>	<b>S22</b>	<b>S20</b>
2"	<b>S78</b>	<b>S27</b>	<b>S25</b>
2½"	<b>S93</b>	<b>S32</b>	<b>S30</b>
3"	<b>S111</b>	<b>S38</b>	<b>S36</b>
4"	<b>S123</b>	<b>S42</b>	<b>S40</b>
5"	---	<b>S57</b>	<b>S55</b>
6"	<b>S183</b>	<b>S62</b>	<b>S60</b>

Size	Plated Iron shank with Brass nut Complete Part #	Plated Iron shank with Brass nut Female Part #	Plated Iron Male Part #
1"	<b>SB33</b> <sup>1</sup>	<b>SB12</b> <sup>1</sup>	<b>S10</b>
1¼"	<b>SB48</b>	<b>SB17</b>	<b>S15</b>
1½"	<b>SB63</b>	<b>SB22</b>	<b>S20</b>
2"	<b>SB78</b>	<b>SB27</b>	<b>S25</b>
2½"	<b>SB93</b>	<b>SB32</b>	<b>S30</b>
3"	<b>SB111</b>	<b>SB38</b>	<b>S36</b>
4"	<b>SB123</b>	<b>SB42</b>	<b>S40</b>
5"	---	<b>SB57</b>	<b>S55</b>
6"	<b>SB183</b>	<b>SB62</b>	<b>S60</b>

<sup>1</sup> 1" fittings have a hex nut design

- complete couplings supplied with rubber gaskets
- Replacement gaskets (KRW standard) are available, see page 205.



King™ Short Shank Suction Hose Couplings  
NST Couplings

Application:

- for suction or discharge of water

Size	Aluminum shank with Brass nut Complete Part #	Aluminum shank with Brass nut Female Part #	Aluminum Male Part #
1½"	<b>CAB150N</b>	<b>FAB150N</b>	<b>MA150N</b>
2½"	<b>CAB250N</b>	<b>FAB250N</b>	<b>MA250N</b>

Size	Brass shank with Brass nut Complete Part #	Brass shank with Brass nut Female Part #	Brass Male Part #
1½"	<b>BS63N</b>	<b>BS22N</b>	<b>BS201</b>
2½"	<b>BS93N</b>	<b>BS32N</b>	<b>BS301</b>

Size	Plated Iron shank with Plated Iron nut Complete Part #	Plated Iron shank with Plated Iron nut Female Part #	Plated Iron Male Part #
1½"	<b>S63N</b>	<b>S22N</b>	<b>S201</b>
2½"	<b>S93N</b>	<b>S32N</b>	<b>S301</b>

Size	Plated Iron shank with Brass nut Complete Part #	Plated Iron shank with Brass nut Female Part #	Plated Iron Male Part #
1½"	<b>SB63N</b>	<b>SB22N</b>	<b>S201</b>
2½"	<b>SB93N</b>	<b>SB32N</b>	<b>S301</b>



complete

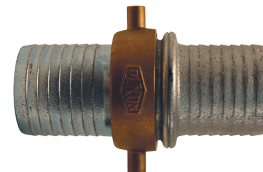

female



male

- NST (Common Fire Hose Thread) is also known as NH
- Replacement gaskets (KRW standard) are available, see page 205.

Steel King™ Short Shank Suction Couplings  
NPSM Couplings

Application:

- for suction or discharge of water

Size	Plated Steel shank with Plated Iron nut Complete Part #	Plated Steel shank with Plated Iron nut Female Part #	Plated Steel Male Part #
1¼"	<b>CSM125</b>	<b>FCSM125</b>	<b>MCS125</b>
1½"	<b>CSM150</b>	<b>FCSM150</b>	<b>MCS150</b>
2"	<b>CSM200</b>	<b>FCSM200</b>	<b>MCS200</b>
2½"	<b>CSM250</b>	<b>FCSM250</b>	<b>MCS250</b>
3"	<b>CSM300</b>	<b>FCSM300</b>	<b>MCS300</b>
4"	<b>CSM400</b>	<b>FCSM400</b>	<b>MCS400</b>
6"	<b>CSM600</b>	<b>FCSM600</b>	<b>MCS600</b>

Size	Plated Steel shank with Brass nut Complete Part #	Plated Steel shank with Brass nut Female Part #	Plated Steel Male Part #
1¼"	<b>CSB125</b>	<b>FCSB125</b>	<b>MCS125</b>
1½"	<b>CSB150</b>	<b>FCSB150</b>	<b>MCS150</b>
2"	<b>CSB200</b>	<b>FCSB200</b>	<b>MCS200</b>
2½"	<b>CSB250</b>	<b>FCSB250</b>	<b>MCS250</b>
3"	<b>CSB300</b>	<b>FCSB300</b>	<b>MCS300</b>
4"	<b>CSB400</b>	<b>FCSB400</b>	<b>MCS400</b>
6"	<b>CSB600</b>	<b>FCSB600</b>	<b>MCS600</b>



complete



female

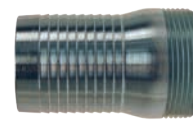

male

- Replacement gaskets (KRW standard) are available, see page 205.

## Super King™ Long Shank Hose Couplings Female NPSM Couplings

### Application:

- for liquid transfer where steel and stainless are preferred

Size	Shank Length	Plated Steel Shank with Brass Pin Lug Nut <sup>1</sup> Part #	Plated Steel Shank with Iron Pin Lug Nut <sup>1</sup> Part #
1¼"	4⅞"	<b>SD15</b>	<b>SDMP15</b>
1½"	4⅞"	<b>SD20</b>	<b>SDMP20</b>
2"	5"	<b>SD25</b>	<b>SDMP25</b>
2½"	5"	<b>SD30</b>	<b>SDMP30</b>
3"	5"	<b>SD35</b>	<b>SDMP35</b>
4"	5"	<b>SD40</b>	<b>SDMP40</b>

Size	Shank Length	316 Stainless Shank with Iron Pin Lug Nut <sup>1</sup> Part #	316 Stainless Shank with Stainless Hex Nut <sup>2</sup> Part #
1½"	4⅞"	---	<b>RSHR20</b>
2"	5"	<b>RSDM25</b>	<b>RSDR25</b>
3"	5"	<b>RSDM35</b>	---

<sup>1</sup> KLW leather gaskets standard

<sup>2</sup> PTFE gaskets standard



pin lug nut



hex nut

### Male NPT Couplings

Size	Shank Length	Plated Steel Part #	316 Stainless Part #
1¼"	4-3/8"	<b>SK16</b>	---
1½"	4-5/32"	<b>SK21</b>	---
2"	5-5/16"	<b>SK26</b>	<b>RSK26</b>
2½"	5-5/16"	<b>SK31</b>	---
3"	5-1/2"	<b>SK36</b>	<b>RSK36</b>
4"	5-1/2"	<b>SK46</b>	---

- all Super King™ long shank couplings accept 3 band clamps

### Pin Lug Spanner Wrenches

#### Single End

Size	Plated Iron Part #
2"	<b>SW20</b>
2½"	<b>SW25</b>
3"	<b>SW30</b>
4"	<b>SW40</b>
6"	<b>SW60</b>



#### Double End

Size	Plated Iron Part #
1½", 2" x 2½", 3"	<b>SW153</b>



- additional spanner wrenches are available on pages 799 - 802

## Short Shank Hose Couplings

## Complete NPSM Couplings

Size	316 Stainless Steel Part #
1/2"	<b>RES404</b>
3/4"	<b>RES606</b>
1"	<b>RES808</b>
1 1/4"	<b>RES48</b>
1 1/2"	<b>RES63</b>
2"	<b>RES78</b>



- Standard gasket is rubber (KRW); for FKM gaskets (KVW) see page 205.

## Female NPSM Couplings

Size	316 Stainless Steel Part #
1/2"	<b>RES444</b>
3/4"	<b>RES646</b>
1"	<b>RES848</b>
1 1/4"	<b>RES33</b>
1 1/2"	<b>RES43</b>
2"	<b>RES53</b>



- Standard gasket is rubber (KRW); for FKM gaskets (KVW) see page 205.

## Machined Short Shank Hose Couplings

## Complete NPSM Couplings

Hose ID	NPSM Thread	Previous Part #	Brass Part #
1/2"	3/4"	---	<b>BS406</b>
3/4"	3/4"	---	<b>BS606</b>
1"	1"	BS808 <sup>1</sup>	<b>5921616K</b> <sup>1,2</sup>



<sup>1</sup> NPSH threads

<sup>2</sup> washer is **5911212W**

- use with KRW washers on page 205

## Female NPSM Couplings

Hose ID	NPSM Thread	Previous Part #	Brass Part #
1/2"	3/4"	---	<b>BS446</b>
5/8"	3/4"	---	<b>BS546</b>
3/4"	3/4"	---	<b>BS646</b>
1"	1"	BS848 <sup>1</sup>	<b>5911616C</b> <sup>1,2</sup>

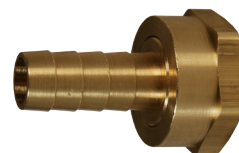

<sup>1</sup> NPSH threads

<sup>2</sup> washer is **5911212W**

- use with KRW washers on page 205

## Male NPSM Couplings

Hose ID	NPSM Thread	Previous Part #	Brass Part #
1/2"	3/4"	---	<b>BS416</b>
3/4"	3/4"	---	<b>BS616</b>
1"	1"	BS818 <sup>1</sup>	<b>5901616C</b> <sup>1</sup>

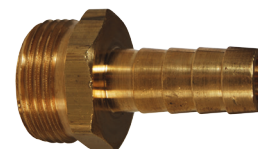

<sup>1</sup> NPSH threads

- use with KRW washers on page 205



plated steel

## Long Shank Hose Couplings

## Complete NPSM Couplings

Hose ID	NPSM Thread	Plated Steel Part #	Plated Iron Part #	Previous Part #	Brass Part #
1/2"	1/2"	<b>SLS404</b>	---	---	<b>BLS404</b>
1/2"	3/4"	---	---	---	<b>BLS406</b>
5/8"	3/4"	---	---	---	<b>BLS506</b>
3/4"	3/4"	<b>SLS606</b>	---	---	<b>BLS606</b>
1"	1"	<b>SLS808</b>	---	BLS808	<b>5951616K</b> <sup>1,2</sup>
1 1/4"	1 1/4"	---	<b>MLS48</b>	---	<b>BLS48</b>
1 1/2"	1 1/2"	---	<b>MLS63</b>	---	<b>BLS63</b>
2"	2"	---	<b>MLS78</b>	---	<b>BLS78</b>

<sup>1</sup> NPSH thread<sup>2</sup> washer is **5911616W**

- sizes 1/2" to 1" are machined; 1 1/4" to 2" are cast
- replacement gaskets (KRW standard) available on page 205

## Female NPSM Couplings

Hose ID	NPSM Thread	Plated Steel Part #	Plated Iron Part #	Previous Part #	Brass Part #
1/2"	1/2"	<b>SLS444</b>	---	---	<b>BLS444</b>
1/2"	3/4"	---	---	---	<b>BLS446</b>
5/8"	3/4"	---	---	---	<b>BLS546</b>
3/4"	3/4"	<b>SLS646</b>	---	---	<b>BLS646</b>
1"	1"	<b>SLS848</b>	---	BLS848	<b>5941616C</b> <sup>1,2</sup>
1 1/4"	1 1/4"	---	<b>MLS33</b>	---	<b>BLS33</b>
1 1/2"	1 1/2"	---	<b>MLS43</b>	---	<b>BLS43</b>
2"	2"	---	<b>MLS53</b>	---	<b>BLS53</b>

<sup>1</sup> NPSH thread<sup>2</sup> washer is **5911616W**

- 1/2" to 1" are machined; 1 1/4" to 2" are cast
- replacement gaskets (KRW standard) available on page 205

## Male NPSM Couplings

Hose ID	NPSM Thread	Plated Steel Part #	Plated Iron Part #	Previous Part #	Brass Part #
1/2"	1/2"	<b>SLS414</b>	---	---	<b>BLS414</b>
1/2"	3/4"	---	---	---	<b>BLS416</b>
5/8"	3/4"	---	---	---	<b>BLS516</b>
3/4"	3/4"	<b>SLS616</b>	---	---	<b>BLS616</b>
1"	1"	<b>SLS818</b>	---	BLS818	<b>5931616C</b> <sup>1</sup>
1 1/4"	1 1/4"	---	<b>MLS15</b>	---	<b>BLS15</b>
1 1/2"	1 1/2"	---	<b>MLS20</b>	---	<b>BLS20</b>
2"	2"	---	<b>MLS25</b>	---	<b>BLS25</b>

<sup>1</sup> NPSH thread

- 1/2" to 1" are machined; 1 1/4" to 2" are cast



plated steel

Long Shank Hose Couplings

Complete NST Couplings

Hose ID	NST Thread	Brass Part #
1½"	1½"	<b>BLS63NST</b>
2½"	2½"	<b>BLS93NST</b>



Industrial Hose Fittings

- replacement gaskets (KRW standard) available on page 205
- for GHT long shank complete couplings see page 237

Female NST Couplings

Hose ID	NST Thread	Brass Part #
1½"	1½"	<b>BLS150NST</b>
2½"	2½"	<b>BLS250NST</b>



- replacement gaskets (KRW standard) available on page 205
- for GHT long shank female coupling see page 237

Male NST Couplings

Hose ID	NST Thread	Brass Part #
1½"	1½"	<b>BLS20NST</b>
2½"	2½"	<b>BLS30NST</b>

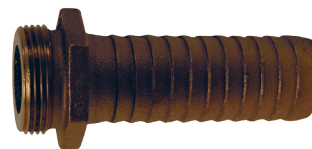

- for GHT long shank male coupling see page 237



## Spray Hose Couplings

## Complete NPSM Couplings

Hose ID	NPSM Thread	Plated Steel Part #
3/8"	3/4"	<b>SS306</b>
1/2"	1/2"	<b>SS404</b>
1/2"	3/4"	<b>SS406</b>
3/4"	3/4"	<b>SS606</b>
1"	1"	<b>SS808</b>

- for GHT spray hose complete coupling see page 238
- replacement KLW (leather gaskets) standard, can be found on page 205

## Female NPSM Couplings

Hose ID	NPSM Thread	Plated Steel Part #
3/8"	3/4"	<b>SS346</b>
1/2"	1/2"	<b>SS444</b>
1/2"	3/4"	<b>SS446</b>
3/4"	3/4"	<b>SS646</b>
1"	1"	<b>SS848</b>

- for GHT spray hose female coupling see page 238
- replacement KLW (leather gaskets) standard, can be found on page 205

## Male NPSM Couplings



Hose ID	NPSM Thread	Plated Steel Part #
3/8"	3/4"	<b>SS316</b>
1/2"	1/2"	<b>SS414</b>
1/2"	3/4"	<b>SS416</b>
3/4"	3/4"	<b>SS616</b>
1"	1"	<b>SS818</b>

- for GHT spray hose male coupling see page 238

Gaskets for Suction, Short, Long and Spray Hose Couplings

• for use on NPSM threaded couplings

Hose ID	Rubber (Styrene Butadiene) Part #	Neoprene Part #	FKM Part #
½"	<b>KRW1</b>	---	---
¾"	<b>KRW5</b>	<b>KNW5</b>	---
1"	<b>KRW10</b>	<b>KNW10</b>	<b>KVW10</b>
1¼"	<b>KRW15</b>	<b>KNW15</b>	---
1½"	<b>KRW20</b>	<b>KNW20</b>	<b>KVW20</b>
2"	<b>KRW25</b>	<b>KNW25</b>	<b>KVW25</b>
2½"	<b>KRW30</b>	<b>KNW30</b>	---
3"	<b>KRW35</b>	<b>KNW35</b>	<b>KVW35</b>
4"	<b>KRW40</b>	<b>KNW40</b>	---
5"	<b>KRW50</b>	---	---
6"	<b>KRW60</b>	<b>KNW60</b>	---
8"	<b>KRW80</b>	<b>KNW80</b>	---



rubber



neoprene



FKM



leather



rubber

Hose ID	Leather Part #	Rubber Part #
½"	<b>KLW1</b>	---
¾"	<b>KLW5</b>	---
1"	<b>KLW10</b>	---
1¼"	<b>KLW15</b>	---
1½"	<b>KLW20</b>	<b>KRW2075<sup>1</sup></b>
2"	<b>KLW25</b>	---
2½"	<b>KLW30</b>	<b>KRW3075<sup>1</sup></b>
3"	<b>KLW35</b>	---
4"	<b>KLW40</b>	---

<sup>1</sup> NST only threaded couplings

Strainers

**Application:**

- used on the submersed end of suction hose to prevent debris from entering the pump during operation

**Round Hole Strainers**



zinc plated steel



304 stainless steel

NPSM Size	Zinc Plated Steel Part #	304 Stainless Steel Part #
3/4"	<b>RHS5</b>	---
1"	<b>RHS10</b>	---
1 1/2"	<b>RHS20</b>	<b>RRHS20</b>
2"	<b>RHS25</b>	<b>RRHS25</b>
2 1/2"	<b>RHS30</b>	---
3"	<b>RHS35</b>	<b>RRHS35</b>
4"	<b>RHS40</b>	<b>RRHS40</b>
6"	<b>RHS60</b>	<b>RRHS60</b>
8"	<b>RHS80</b>	---
10"	<b>RHS100</b>	---
12"	<b>RHS120</b>	---

**Square Hole Strainers**



NPSM Size	Zinc Plated Steel Part #
2"	<b>SHS25</b>
3"	<b>SHS35</b>
4"	<b>SHS40</b>
6"	<b>SHS60</b>
8"	<b>SHS80</b>
10"	<b>SHS100</b>
12"	<b>SHS120</b>

**Polypropylene Strainers**



NPT Size	Black Polypropylene with 30% fiberglass Part #
1 1/2"	<b>TSS20</b>
2"	<b>TSS25</b>
3"	<b>TSS35</b>
4"	<b>TSS40</b>



Strainers

Round Hole Long Strainers

NPSM Size	Zinc Plated Steel Part #
1½"	<b>RSS20</b>
2"	<b>RSS25</b>
3"	<b>RSS35</b>
4"	<b>RSS40</b>



Industrial Hose  
Fittings

Skimmers

Round Hole Bottom Skimmers

NPSM Size	Zinc Plated Steel Part #
1½"	<b>DSB20</b>
2"	<b>DSB25</b>
3"	<b>DSB35</b>



Round Hole Top Skimmers

NPSM Size	Zinc Plated Steel Part #
1½"	<b>DST20</b>
2"	<b>DST25</b>
3"	<b>DST35</b>



Foot Valves

Application:

- for use on water suction hose to prevent pump from losing it's prime
- **must** be installed in the *vertical position*
- for water service *only*
- not for compressed air or other compressible gases 



NPT Size	Painted Cast Iron Part #
1½"	DFVS20
2"	DFVS25
2½"	DFVS30
3"	DFVS35
4"	DFVS40
6"	DFVS60
8"	DFVS80

Strainers



Size	Painted Cast Iron Part #
1½"	FVS20
2"	FVS25
2½"	FVS30
3"	FVS35
4"	FVS40
6"	FVS60
8"	FVS80

Flapper Assemblies



Size	Painted Cast Iron / Rubber Part #
1½"	FVFA20
2"	FVFA25
2½"	FVFA30
3"	FVFA35
4"	FVFA40
6"	FVFA60
8"	FVFA80

Flapper Gaskets



Size	Rubber Part #
1½"	FVL20
2"	FVL25
2½"	FVL30
3"	FVL35
4"	FVL40
6"	FVL60
8"	FVL80

Seat Plates



Size	Painted Cast Iron Part #
1½"	FVSP20
2"	FVSP25
2½"	FVSP30
3"	FVSP35
4"	FVSP40
6"	FVSP60
8"	FVSP80

Dixon® Hose Menders

- **not for compressible products such as air, nitrogen or steam**
- *The working pressure may vary with the construction of the hose, the type of clamping system used and the application. Consult Dixon® for recommendations.*
- In accordance with the ARPM bulletin for oil suction and discharge hose, a coupled length of hose in any size, should be tested to 1½ times the working pressure and held for fifteen minutes without leaking or coupling movement. For additional information and detailed instruction on testing procedures, see the Association for Rubber Products Manufacturer's (ARPM) handbook or visit ARPMINC.com.



Size	Zinc Plated Steel Part #	Optional Qty	316 Stainless Steel Part #	Optional Qty
¼"	<b>DMA</b>	200	<b>RDMA</b>	100
⅜"	<b>DMB</b>	100	<b>RDMB</b>	100
½"	<b>DM1</b>	50	<b>RDM1</b>	50
⅝"	<b>DM5</b>	50	---	---
¾"	<b>DM6</b>	50	<b>RDM6</b>	50
1"	<b>DM11</b>	50	<b>RDM11</b>	50
1¼"	<b>DM16</b>	50	<b>RDM16</b>	5
1⅜"	<b>DM18</b>	50	---	---
1½"	<b>DM21</b>	50	<b>RDM21</b>	50
1½"	<b>DMXL21</b> <sup>1</sup>	25	---	---
2"	<b>DM26</b>	50	<b>RDM26</b>	10
2"	<b>DMXL26</b> <sup>1</sup>	25	---	---
2½"	<b>DM31</b>	25	---	---
3"	<b>DM36</b>	20	<b>RDM36</b>	5
4"	<b>DM46</b>	10	<b>RDM46</b>	5
5"	<b>DM51</b>	5	---	---
6"	<b>DM66</b>	4	---	---
8"	<b>DM86</b>	1	---	---
10"	<b>DM100</b>	1	---	---
12"	<b>DM120</b>	1	---	---



zinc plated steel



316 stainless steel

<sup>1</sup> XL series has extra long shank

## King™ Hose Menders

- **not for compressible products such as air, nitrogen or steam**
- *The working pressure may vary with the construction of the hose, the type of clamping system used and the application. Consult Dixon® for recommendations.*
- In accordance with the ARPM bulletin for oil suction and discharge hose, a coupled length of hose in any size, should be tested to 1½ times the working pressure and held for fifteen minutes without leaking or coupling movement. For additional information and detailed instruction on testing procedures, see the Association for Rubber Products Manufacturer's (ARPM) handbook or visit ARPMINC.com.



## for one clamp



Size	Steel Part #
1/4"	<b>KM21</b>
5/16"	<b>KM251</b>
1/2"	<b>KM41</b>
5/8"	<b>KM51</b>
3/4"	<b>KM61</b>
1"	<b>KM81</b>
1-1/4"	<b>KM101</b>
1-1/2"	<b>KM121</b>

## for two clamps



Size	Steel Part #
1/2"	<b>KM42</b>
5/8"	<b>KM52</b>
3/4"	<b>KM62</b>
1"	<b>KM82</b>
1¼"	<b>KM102</b>
1½"	<b>KM122</b>
2"	<b>KM162</b>

## Barbed Hose Menders



Hose ID	Lead Free Brass <sup>1</sup>	Brass	
	Part #	Previous Part #	Part #
1/8"	---	BM1	<b>1780202C</b>
3/16"	---	BM15	<b>1780303C</b>
1/4" x 1/8"	---	BM2-1	<b>1780402C</b>
1/4"	<b>1780404CLF</b>	BM2	<b>1780404C</b>
5/16"	---	BM25	<b>1780505C</b>
3/8" x 1/4"	---	BM3-2	<b>1780604C</b>
3/8"	<b>1780606CLF</b>	BM3	<b>1780606C</b>
1/2" x 3/8"	---	BM4-3	<b>1780806C</b>
1/2"	<b>1780808CLF</b>	BM4	<b>1780808C</b>
5/8" x 3/8"	---	BM5-3	<b>1781006C</b>
5/8" x 1/2"	---	BM5-4	<b>1781008C</b>
5/8"	---	BM5	<b>1781010C</b>
3/4" x 1/2"	---	BM6-4	<b>1781208C</b>
3/4"	---	BM6	<b>1781212C</b>
1"	---	BM8	<b>1781616C</b>

<sup>1</sup> Lead free brass <=0.25% lead; Alloy CA2745; Alloy C46400

## Short Shank Menders



Size	Length	Previous Part #	316 Stainless Steel Part #
¼"	2-1/32"	1780404SS	<b>RM2</b>
⅜"	2-1/16"	1780606SS	<b>RM3</b>
½"	2-1/16"	1780808SS	<b>RM4</b>
¾"	2-1/2"	1781212SS	<b>RM6</b>

## Male NPTF x Hose Barb

- Optional package quantity

Hose ID	Male NPTF	Brass		Lead Free Brass <sup>1,3</sup> Part #	316 Stainless Steel <sup>1</sup> Part #	Pkg Qty
		Previous Part #	Part #			
1/8"	1/8"	BN11	<b>1020202C</b>	---	<b>RN11</b>	100
	1/4"	BN122	<b>1020204C</b>	---	---	100
3/16"	1/8"	BN151	<b>1020302C</b>	<b>1020302CLF</b>	<b>RN151</b>	100
	1/4"	BN152	<b>1020304C</b>	---	<b>RN152</b>	100
1/4"	1/8"	BN21	<b>1020402C</b>	<b>1020402CLF</b>	<b>RN21</b>	100
	1/4"	BN22	<b>1020404C</b>	<b>1020404CLF</b>	<b>RN22</b>	100
	3/8"	BN23	<b>1020406C</b>	---	<b>RN23</b>	100
	1/2"	BN24	<b>1020408C</b>	---	---	50
5/16"	1/8"	BN251	<b>1020502C</b>	<b>1020502CLF</b>	<b>RN251</b>	100
	1/4"	BN252	<b>1020504C</b>	<b>1020504CLF</b>	<b>RN252</b>	50
	3/8"	BN253	<b>1020506C</b>	---	<b>RN253</b>	50
3/8"	1/8"	BN31	<b>1020602C</b>	<b>1020602CLF</b>	<b>RN31</b>	100
	1/4"	BN32	<b>1020604C</b>	<b>1020604CLF</b>	<b>RN32</b>	100
	3/8"	BN33	<b>1020606C</b>	<b>1020606CLF</b>	<b>RN33</b>	50
	1/2"	BN34	<b>1020608C</b>	<b>1020608CLF</b>	<b>RN34</b>	25
	3/4"	BN36	<b>1020612C</b>	---	---	25
	1/2"	1/4"	BN42	<b>1020804C</b>	<b>1020804CLF</b>	<b>RN42</b>
3/8"		BN43	<b>1020806C</b>	<b>1020806CLF</b>	<b>RN43</b>	50
1/2"		BN44	<b>1020808C</b>	<b>1020808CLF</b>	<b>RN44</b>	25
3/4"		BN46	<b>1020812C</b>	---	<b>RN46</b>	25
5/8"	3/8"	BN53	<b>1021006C</b>	---	<b>RN53</b>	50
	1/2"	BN54	<b>1021008C</b>	<b>1021008CLF</b>	<b>RN54</b>	25
	3/4"	BN56	<b>1021012C</b>	---	<b>RN56</b>	25
3/4"	1/2"	BN64	<b>1021208C</b>	<b>1021208CLF</b>	<b>RN64</b>	25
	3/4"	BN66	<b>1021212C</b>	<b>1021212CLF</b>	<b>RN66</b>	20
1"	3/4"	BN86	<b>1021612C</b>	---	<b>RN86</b>	20
	1"	BN88	<b>1021616C</b> <sup>2</sup>	---	<b>RKHN881</b> <sup>4</sup>	10
1 1/4"	3/4"	BN106	<b>1022012C</b>	---	---	10
	1"	BN108	<b>1022016C</b> <sup>2</sup>	---	---	5

<sup>1</sup> NPT thread

<sup>2</sup> capped

<sup>3</sup> Lead free brass <=0.25% lead; Alloy CA2745; Alloy C46400

<sup>4</sup> same shank style as KHN881 shown on page 197

Industrial Hose Fittings



brass



316 stainless steel

D

## Male NPTF Swivel x Hose Barb

- Optional package quantity

Hose ID	Male NPTF	Brass		Pkg Qty
		Previous Part #	Part #	
1/4"	1/8"	103-0402	<b>1030402C</b>	100
	1/4"	103-0404	<b>1030404C</b>	100
3/8"	1/4"	103-0604	<b>1030604C</b>	100
	3/8"	103-0606	<b>1030606C</b>	50
1/2"	3/8"	103-0806	<b>1030806C</b>	50
	1/2"	103-0808	<b>1030808C</b>	25
3/4"	3/4"	103-1212	<b>1031212C</b>	20
1"	1-1 1/2"	103-1616	<b>1031616C</b> <sup>1</sup>	10



<sup>1</sup> capped threads

- swivel is for assembly convenience only, not for live swivel applications **120 PSI** maximum



Male NPTF x Beaded Hose Barb

Hose ID	Male NPTF	Brass Part #	Pkg Qty
1/4"	1/8"	<b>268B0402</b>	100
	1/4"	<b>268B0404</b>	100
5/16"	1/8"	<b>268B0502</b>	100
	1/4"	<b>268B0504</b>	50
3/8"	1/8"	<b>268B0602</b>	100
	1/4"	<b>268B0604</b>	100
	3/8"	<b>268B0606</b>	50
1/2"	3/8"	<b>268B0806</b>	50
	1/2"	<b>268B0808</b>	50
5/8"	1/2"	<b>268B1008</b>	25
3/4"	1/2"	<b>268B1208</b>	50
	3/4"	<b>268B1212</b>	25

Male BSPT x Hose Barb



Hose ID	Male BSPT	Brass		Pkg Qty
		Previous Part #	Part #	
1/4"	1/8"	BN21BSPT	<b>1020402BSPT</b>	100
	1/4"	BN22BSPT	<b>1020404BSPT</b>	100
3/8"	1/4"	BN32BSPT	<b>1020604BSPT</b>	100
	3/8"	BN33BSPT	<b>1020606BSPT</b>	50
1/2"	1/2"	BN34BSPT	<b>1020608BSPT</b>	25
	3/8"	BN43BSPT	<b>1020806BSPT</b>	50
3/4"	1/2"	BN44BSPT	<b>1020808BSPT</b>	50
	3/4"	BN66BSPT	<b>1021212BSPT</b>	25
1"	1"	BN88BSPT	<b>1021616BSPT</b>	10

Female NPTF x Hose Barb



brass

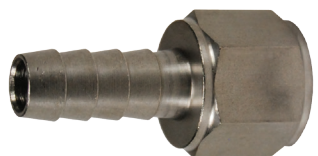

303 stainless steel

Hose ID	Female NPTF	Brass		Lead Free Brass <sup>1,2</sup> Part #	303 Stainless Steel <sup>1</sup>		Pkg Qty
		Previous Part #	Part #		Previous Part #	Part #	
1/8"	1/8"	BF11	<b>1040202C</b>	---	---	---	100
	1/4"	BF12	<b>1040204C</b>	---	---	---	100
3/16"	1/8"	BF151	<b>1040302C</b>	---	---	---	100
	1/4"	BF152	<b>1040304C</b>	---	---	---	100
1/4"	1/8"	BF21	<b>1040402C</b>	---	---	---	100
	1/4"	BF22	<b>1040404C</b>	<b>1040404CLF</b>	BF22SS	<b>1040404SS</b>	100
	3/8"	BF23	<b>1040406C</b>	---	---	---	50
	1/2"	BF24	<b>1040408C</b>	---	---	---	50
5/16"	1/8"	BF251	<b>1040502C</b>	---	---	---	100
	1/4"	BF252	<b>1040504C</b>	---	---	---	100
	3/8"	BF253	<b>1040506C</b>	---	---	---	100
3/8"	1/8"	BF31	<b>1040602C</b>	---	---	---	100
	1/4"	BF32	<b>1040604C</b>	<b>1040604CLF</b>	BF32SS	<b>1040604SS</b>	50
	3/8"	BF33	<b>1040606C</b>	<b>1040606CLF</b>	BF33SS	<b>1040606SS</b>	50
	1/2"	BF34	<b>1040608C</b>	<b>1040608CLF</b>	---	---	50
1/2"	3/4"	BF36	<b>1040612C</b>	---	---	---	25
	1/4"	BF42	<b>1040804C</b>	---	---	---	50
	3/8"	BF43	<b>1040806C</b>	---	---	---	50
	1/2"	BF44	<b>1040808C</b>	<b>1040808CLF</b>	BF44SS	<b>1040808SS</b>	50
5/8"	3/4"	BF46	<b>1040812C</b>	---	---	---	25
	3/8"	BF53	<b>1041006C</b>	---	---	---	50
	1/2"	BF54	<b>1041008C</b>	---	---	---	25
	3/4"	BF56	<b>1041012C</b>	---	---	---	25
3/4"	1/2"	BF64	<b>1041208C</b>	---	---	---	25
	3/4"	BF66	<b>1041212C</b>	---	---	---	20
1"	3/4"	BF86	<b>1041612C</b>	---	---	---	20
	1"	BF88	<b>1041616C</b>	---	---	---	10
1-1/4"	1"	BF108	<b>1042016C</b>	---	---	---	10

<sup>1</sup> NPT threads and are packaged to order

<sup>2</sup> Lead free brass ≤0.25% lead; Alloy CA2745; Alloy C46400

## Female NPSM Swivel x Hose Barb Ball Seat

Hose ID	Female NPSM	Brass		Pkg Qty
		Previous Part #	Part #	
1/8"	1/8"	BFS11	<b>1240202K</b>	100
3/16"	1/8"	BFS151	<b>1240302K</b>	100
	1/4"	BFS152	<b>1240304K</b>	100
1/4"	1/8"	BFS21	<b>1240402K</b>	100
	1/4"	BFS22	<b>1240404K</b>	100
	3/8"	BFS23	<b>1240406K</b>	100
5/16"	1/4"	BFS252	<b>1240504K</b>	100
	3/8"	BFS253	<b>1240506K</b>	50
3/8"	1/4"	BFS32	<b>1240604K</b>	100
	3/8"	BFS33	<b>1240606K</b>	100
	1/2"	BFS34	<b>1240608K</b>	100
1/2"	3/8"	BFS43	<b>1240806K</b>	50
	1/2"	BFS44	<b>1240808K</b>	100
3/4"	3/4"	BFS66	<b>1241212K</b>	50



Industrial Hose Fittings

## Female NPSM Swivel x Hose Barb Gasket Seat

Hose ID	Female NPSM	Brass		Pkg Qty
		Previous Part #	Part #	
1/8"	1/8"	126-0202	<b>1260202C</b>	100
3/16"	1/8"	126-0302	<b>1260302C</b>	100
	1/4"	126-0304	<b>1260304C</b>	100
1/4"	1/8"	126-0402	<b>1260402C</b>	100
	1/4"	126-0404	<b>1260404C</b>	100
	3/8"	126-0406	<b>1260406C</b>	100
5/16"	1/4"	126-0504	<b>1260504C</b>	100
3/8"	1/4"	126-0604	<b>1260604C</b>	100
	3/8"	126-0606	<b>1260606C</b>	50
	1/2"	126-0608	<b>1260608C</b>	50
1/2"	3/8"	126-0806	<b>1260806C</b>	50
	1/2"	126-0808	<b>1260808C</b>	50
3/4"	3/4"	126-1212	<b>1261212C</b>	25



- not recommended for water applications

## Male NPTF x Hose Barb 90° Elbow



Hose ID	Male NPTF	Brass		Lead Free Brass <sup>2,3</sup> Part #
		Previous Part #	Part #	
3/16"	1/8"	EL15H1M	<b>1290302C</b>	---
1/4"	1/8"	EL2H1M	<b>1290402C</b>	---
	1/4"	EL2H2M	<b>1290404C</b>	<b>1290404CLF</b>
	3/8"	EL2H3M	<b>1290406C</b>	---
5/16"	1/8"	EL25H1M	<b>1290502C</b>	---
	1/4"	EL25H2M	<b>1290504C</b>	---
	3/8"	EL25H3M	<b>1290506C</b>	---
3/8"	1/8"	EL3H1M	<b>1290602C</b>	---
	1/4"	EL3H2M	<b>1290604C</b>	<b>1290604CLF</b>
	3/8"	EL3H3M	<b>1290606C</b>	<b>1290606CLF</b>
	1/2"	EL3H4M	<b>1290608C</b>	---
1/2"	1/4"	EL4H2M	<b>1290804C</b>	---
	3/8"	EL4H3M	<b>1290806C</b>	---
	1/2"	EL4H4M	<b>1290808C</b>	---
5/8"	3/8"	EL5H3M	<b>1291006C</b>	---
	1/2"	EL5H4M	<b>1291008C</b>	---
3/4"	1/2"	EL6H4M	<b>1291208C</b>	---
	3/4"	EL6H6M	<b>1291212C</b>	---
1"	3/4"	EL8H6M	<b>1291612C</b>	---
	1"	EL8H8M	<b>1291616C</b> <sup>1</sup>	---

<sup>1</sup> capped<sup>2</sup> Lead free brass <=0.25% lead; Alloy CA2745; Alloy C46400<sup>3</sup> NPT thread

Hose ID	Male NPT	Stainless Steel		Pkg Qty
		Previous Part #	Part #	
1/4"	1/8"	EL2H1MSS	<b>1290402SS</b>	50
	1/4"	EL2H2MSS	<b>1290404SS</b>	50
3/8"	1/4"	EL3H2MSS	<b>1290604SS</b>	50
	3/8"	EL3H3MSS	<b>1290606SS</b>	50
1/2"	1/4"	EL4H2MSS	<b>1290804SS</b>	50
	3/8"	EL4H3MSS	<b>1290806SS</b>	50
	1/2"	EL4H4MSS	<b>1290808SS</b>	25
3/4"	1/2"	EL6H4MSS	<b>1291208SS</b>	25
	3/4"	EL6H6MSS	<b>1291212SS</b>	25

## Female NPTF x Hose Barb 90° Elbow



Hose ID	Female NPTF	Brass		Pkg Qty
		Previous Part #	Part #	
1/4"	1/8"	134-0402	<b>1340402C</b>	50
	1/4"	134-0404	<b>1340404C</b>	50
3/8"	1/4"	134-0604	<b>1340604C</b>	50
	3/8"	134-0606	<b>1340606C</b>	50
1/2"	1/4"	134-0804	<b>1340804C</b>	25
	3/8"	134-0806	<b>1340806C</b>	25
	1/2"	134-0808	<b>1340808C</b>	25
3/4"	3/4"	134-1212	<b>1341212C</b>	25



Barbed 90° Elbow Splicers

Hose ID	Brass		304 Stainless Steel		Pkg Qty
	Previous Part #	Part #	Previous Part #	Part #	
1/8"	177-0202	<b>1770202C</b>	177-0202SS	<b>1770202SS</b>	25
3/16"	177-0303	<b>1770303C</b>	177-0303SS	<b>1770303SS</b>	25
1/4" x 1/8"	177-0402	<b>1770402C</b>	---	---	25
1/4"	177-0404	<b>1770404C</b>	177-0404SS	<b>1770404SS</b>	25
5/16"	177-0505	<b>1770505C</b>	---	---	25
3/8" x 1/4"	177-0604	<b>1770604C</b>	---	---	25
3/8"	177-0606	<b>1770606C</b>	177-0606SS	<b>1770606SS</b>	25
1/2" x 3/8"	177-0806	<b>1770806C</b>	---	---	25
1/2"	177-0808	<b>1770808C</b>	177-0808SS	<b>1770808SS</b>	25
5/8"	177-1010	<b>1771010C</b>	---	---	25
3/4" x 1/2"	177-1208	<b>1771208C</b>	---	---	25
3/4"	177-1212	<b>1771212C</b>	---	---	25

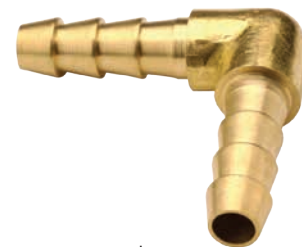

brass



304 stainless steel

Industrial Hose Fittings

Barbed Tee Splicers

Hose ID	Brass		Lead Free Brass Part #	Pkg Qty
	Previous Part #	Part #		
1/8"	179-0202	<b>1790202C</b>	---	25
3/16"	179-0303	<b>1790303C</b>	---	100
1/4" x 1/8"	179-0402	<b>1790402C</b>	---	25
1/4"	179-0404	<b>1790404C</b>	<b>1790404CLF</b>	25
5/16"	179-0505	<b>1790505C</b>	---	25
3/8" x 1/4"	179-0604	<b>1790604C</b> <sup>1</sup>	---	25
3/8" x 1/4"	---	<b>1790604BARB</b>	---	25
3/8"	179-0606	<b>1790606C</b>	<b>1790606CLF</b>	25
1/2" x 3/8"	179-0806	<b>1790806C</b>	---	25
1/2"	179-0808	<b>1790808C</b>	---	25
5/8"	179-1010	<b>1791010C</b>	---	25
3/4" x 1/2"	179-1208	<b>1791208C</b>	---	25
3/4"	179-1212	<b>1791212C</b>	---	20

<sup>1</sup> drop leg has 1/4"-18 male NPTF thread



brass



brass with male NPTF



lead free brass



304 stainless steel

Hose ID	304 Stainless Steel	
	Previous Part #	Part #
1/8"	179-0202SS	<b>1790202SS</b>
3/16"	179-0303SS	<b>1790303SS</b>
1/4"	179-0404SS	<b>1790404SS</b>
3/8"	179-0606SS	<b>1790606SS</b>
1/2"	179-0808SS	<b>1790808SS</b>



## Male NPTF x Hose Barb 45° Elbow

Hose ID	Male NPTF	Brass		Pkg Qty
		Previous Part #	Part #	
1/4"	1/8"	139-0402	<b>1390402C</b>	100
	1/4"	139-0404	<b>1390404C</b>	25
3/8"	1/8"	139-0602	<b>1390602C</b>	100
	1/4"	139-0604	<b>1390604C</b>	100
	3/8"	139-0606	<b>1390606C</b>	25
1/2"	1/4"	139-0804	<b>1390804C</b>	25
	3/8"	139-0806	<b>1390806C</b>	25
	1/2"	139-0808	<b>1390808C</b>	25
3/4"	1/2"	139-1208	<b>1391208C</b>	25

## Male 45° SAE x Hose Barb



Hose ID	Male UNF	Brass		Pkg Qty
		Previous Part #	Part #	
3/16"	7/16"-20	142-0307	<b>1420307C</b>	100
1/4"	7/16"-20	142-0407	<b>1420407C</b>	100
	5/8"-18	142-0410	<b>1420410C</b>	100
5/16"	1/2"-20	142-0508	<b>1420508C</b>	100
3/8"	5/8"-18	142-0610	<b>1420610C</b>	50
	3/4"-16	142-0612	<b>1420612C</b>	50
1/2"	3/4"-16	142-0812	<b>1420812C</b>	50

## Female 45°SAE/37°JIC Swivel x Hose Barb



Hose ID	Tube OD	Female UNF	Brass		Pkg Qty
			Previous Part #	Part #	
3/16"	1/4"	7/16"-20	143-0307	<b>1430307K</b>	100
	1/4"	7/16"-20	143-0407	<b>1430407K</b>	100
1/4"	1/4"	7/16"-20	---	<b>1430407KLF<sup>1</sup></b>	---
	5/16"	1/2"-20	143-0408	<b>1430408K</b>	100
5/16"	5/16"	1/2"-20	143-0508	<b>1430508K</b>	50
3/8"	1/2"	3/4"-16	143-0612	<b>1430612K</b>	100
1/2"	1/2"	3/4"-16	143-0812	<b>1430812K</b>	100
	5/8"	7/8"-14	143-0814	<b>1430814K</b>	50

<sup>1</sup> Lead free brass <=0.25% lead; Alloy CA2745; Alloy C46400

Female 45° SAE Swivel x Hose Barb

Hose ID	Tube OD	Female UNF	Brass		Pkg Qty
			Previous Part #	Part #	
3/16"	3/16"	3/8"-24	144-0306	<b>1440306K</b>	100
1/4"	3/8"	5/8"-18	144-0410	<b>1440410K</b>	100
5/16"	3/8"	5/8"-18	144-0510	<b>1440510K</b>	100
3/8"	3/8"	5/8"-18	144-0610	<b>1440610K</b>	100
1/2"	1/2"	3/4"-16	144-0812	<b>1440812K</b>	100
3/4"	3/4"	1-1/16"-14	144-1217	<b>1441217K<sup>1</sup></b>	25



Industrial Hose Fittings

<sup>1</sup> Notch in nut for SAE identification

Female 37° JIC Swivel x Hose Barb

Hose ID	Tube OD	Female UNF	Brass		Pkg Qty
			Previous Part #	Part #	
3/8"	3/8"	9/16"-18	145-0609	<b>1450609K</b>	100
3/4"	3/4"	1-1/16"-12	145-1217	<b>1451217K</b>	25



Female PTF-SAE Short Swivel x Hose Barb

Hose ID	Female PTF-SAE Short	Brass		Pkg Qty
		Previous Part #	Part #	
1/4"	1/4"	105-0404	<b>1050404C</b>	50
3/8"	1/4"	105-0604	<b>1050604C</b>	50
	3/8"	105-0606	<b>1050606C</b>	50
1/2"	3/8"	105-0806	<b>1050806C</b>	50
	1/2"	105-0808	<b>1050808C</b>	25



- swivel is for assembly convenience only, not for live swivel applications, **120 PSI** maximum

Brass Ferrules for Air & Fluid

• sold in package quantities only

Ferrule ID	Ferrule Length	End Hole Size	Metal Gauge	Std Ind Part #	Bore/Crimp Diameter <sup>1</sup>	Previous Part #	Brass Part #	Pkg Qty
.478"	.688	.328	.024"	4750	0.450	2004750C	<b>BFM478</b>	50
.500"	1	.344	.024"	7322	0.475	2005005C	<b>BFM500</b>	50
.528"	1	.375	.024"	7323	0.500	2005255C	<b>BFM525</b>	50
.528"	1	.438	.024"	7324	0.500	2005310C	<b>BFM531</b>	50
.562"	1	.438	.024"	7325	0.525	2005620C	<b>BFM562</b>	50
.593"	1	.438	.024"	7326	0.550	2005930C	<b>BFM593</b>	50
.625"	1	.438	.024"	7327	0.575	2006255C	<b>BFM625</b>	50
.656"	1	.438	.024"	7328	0.600	2006560C	<b>BFM656</b>	50
.687"	1	.500	.024"	7329	0.625	2006900C	<b>BFM687</b>	50
.718"	1	.625	.024"	7330	0.675	2007180C	<b>BFM718</b>	50
.718"	1	.500	.024"	7330B	0.675	---	<b>BFM718B</b>	50
.750"	1	.625	.024"	7331	0.700	2007505C	<b>BFM750</b>	50
.750"	1	.500	.024"	7331B	0.700	---	<b>BFM750B</b>	50
.781"	1	.625	.024"	7332	0.725	2007810C	<b>BFM781</b>	50
.781"	1	.500	.024"	7332B	0.725	---	<b>BFM781B</b>	50
.812"	1	.625	.024"	7333	0.750	2008120C	<b>BFM812</b>	50
.380"	.500	.266	.016"	622	0.350	---	<b>BFL380</b>	50
.400"	.469	.266	.020"	619	0.375	2004000C	<b>BFL400</b>	50
.410"	.500	.266	.016"	620	0.375	---	<b>BFL410</b>	50
.450"	.469	.344	.016"	769	0.425	2004530C	<b>BFL450</b>	50
.500"	.500	.344	.016"	624	0.450	2005000C	<b>BFL500</b>	50
.525"	.500	.344	.016"	625	0.475	2005250C	<b>BFL525</b>	50
.548"	.484	.375	.016"	626	0.500	2005500C	<b>BFL548</b>	50
.564"	.750	.375	.019"	3588	0.525	---	<b>BFL564</b>	50
.575"	.484	.469	.019"	KK	0.525	---	<b>BFL575</b>	50
.600"	.500	.500	.019"	JJ	0.550	---	<b>BFL600</b>	50
.625"	.500	.500	.019"	II	0.575	2006250C	<b>BFL625</b>	50
.650"	.500	.500	.019"	HH	0.600	2006500C	<b>BFL650</b>	50
.675"	.516	.500	.019"	GG	0.625	2006750C	<b>BFL675</b>	50
.725"	.531	.500	.019"	EE	0.675	2007250C	<b>BFL725</b>	50
.750"	.531	.500	.019"	DD	0.675	2007500C	<b>BFL750</b>	50
.775"	.531	.500	.016"	CC	0.700	2007750C	<b>BFL775</b>	50

<sup>1</sup> Plain die bore diameter can be used as crimp spec ±.005  
 • For use with ribbed and plain dies on page 219

Industrial Hose Fittings



BFM



BFL

Brass Ferrules for Fluid

• sold in package quantities only

Ferrule ID	Ferrule Length	End Hole Size	Metal Gauge	Std Ind Part #	Ribbed Die*	Plain Die*	Bore/Crimp Diameter <sup>1</sup>	Previous Part #	Brass Part #	Pkg Qty
.800"	.844"	.688"	.024"	---	<b>R28</b>	<b>P29</b>	0.750	---	<b>BF800</b>	25
.825"	.844"	.688"	.024"	---	<b>R27</b>	<b>P28</b>	0.775	---	<b>BF825</b>	25
.850"	.563"	.688"	.019"	Z	<b>R26</b>	<b>P27</b>	0.800	---	<b>BF850</b>	25
.875"	.844"	.688"	.024"	7244A	<b>R25</b>	<b>P26</b>	0.825	2008750C	<b>BFW875</b>	25
.900"	.844"	.688"	.024"	5029A	<b>R24</b>	<b>P25</b>	0.850	---	<b>BFW900</b>	25
.937"	.844"	.688"	.024"	7242A	<b>R23</b>	<b>P24</b>	0.875	2009250C	<b>BFW925</b>	25
.975"	.844"	.688"	.024"	5028A	<b>R21</b>	<b>P22</b>	0.925	2009750C	<b>BFW975</b>	25
1.025"	.844"	.693"	.024"	7114A	<b>R19</b>	<b>P20</b>	0.975	2001025C	<b>BFW1025</b>	25
1.175"	.844"	.875"	.024"	7088A	<b>R13</b>	<b>P14</b>	1.125	2001175C	<b>BFW1175</b>	25
1.050"	.625"	.750"	.025"	3605	<b>R18</b>	<b>P19</b>	1.000	---	<b>BFMW1050</b>	25
1.100"	.844"	.812"	.024"	5027A	<b>R16</b>	<b>P17</b>	1.050	2001100C	<b>BFMW1100</b>	25
1.150"	.844"	.875"	.024"	7104A	<b>R15</b>	<b>P15</b>	1.100	2009950C	<b>BFMW1150</b>	25
1.225"	.875"	.875"	.025"	875-K	<b>R11</b>	<b>P12</b>	1.175	2001225C	<b>BFMW1225</b>	25
1.275"	.875"	1.000"	.025"	875-I	<b>R9</b>	<b>P10</b>	1.225	---	<b>BFMW1275</b>	25
1.400"	.687"	1.125"	.019"	D	<b>R4</b>	<b>P5</b>	1.350	---	<b>BFMW1400</b>	25
1.500"	.875"	1.125"	.025"	1500	---	<b>P1</b>	1.450	2001500C	<b>BFMW1500</b>	25

<sup>1</sup> Plain die bore diameter can be used as crimp spec ±.005  
 • For use with ribbed and plain dies on page 219



BFMW

## Ribbed and Plain Dies

Ferrule ID	Std Ind Part #	Bore/Crimp Diameter <sup>1</sup>	Ribbed Die	Plain Die
.478"	4750	0.450	<b>R41</b>	<b>P42</b>
.500"	7322	0.475	<b>R40</b>	<b>P40</b>
.528"	7323	0.500	<b>R39</b>	<b>P39</b>
.528"	7324	0.500	<b>R39</b>	<b>P39</b>
.562"	7325	0.525	<b>R37</b>	<b>P38</b>
.593"	7326	0.550	<b>R36</b>	<b>P37</b>
.625"	7327	0.575	<b>R35</b>	<b>P36</b>
.656"	7328	0.600	<b>R34</b>	<b>P35</b>
.687"	7329	0.625	<b>R33</b>	<b>P34</b>
.718"	7330	0.675	<b>R31</b>	<b>P32</b>
.718"	7330B	0.675	<b>R31</b>	<b>P32</b>
.750"	7331	0.700	<b>R30</b>	<b>P31</b>
.750"	7331B	0.700	<b>R30</b>	<b>P31</b>
.781"	7332	0.725	<b>R29</b>	<b>P30</b>
.781"	7332B	0.725	<b>R29</b>	<b>P30</b>
.812"	7333	0.750	<b>R28</b>	<b>P29</b>
.380"	622	0.350	<b>R44</b>	<b>P45</b>
.400"	619	0.375	<b>R44</b>	<b>P44</b>
.410"	620	0.375	<b>R43</b>	<b>P44</b>
.450"	769	0.425	<b>R41</b>	<b>P42</b>
.500"	624	0.450	<b>R40</b>	<b>P41</b>
.525"	625	0.475	<b>R39</b>	<b>P40</b>
.548"	626	0.500	<b>R38</b>	<b>P39</b>
.564"	3588	0.525	<b>R37</b>	<b>P38</b>
.575"	KK	0.525	<b>R37</b>	<b>P38</b>
.600"	JJ	0.550	<b>R36</b>	<b>P37</b>
.625"	II	0.575	<b>R35</b>	<b>P36</b>
.650"	HH	0.600	<b>R34</b>	<b>P35</b>
.675"	GG	0.625	<b>R34</b>	<b>P34</b>
.725"	EE	0.675	<b>R31</b>	<b>P32</b>
.750"	DD	0.675	<b>R30</b>	<b>P32</b>
.775"	CC	0.700	<b>R31</b>	<b>P31</b>
.800"	---	0.750	<b>R28</b>	<b>P29</b>
.825"	---	0.775	<b>R27</b>	<b>P28</b>
.850"	Z	0.800	<b>R26</b>	<b>P27</b>
.875"	7244A	0.825	<b>R25</b>	<b>P26</b>
.900"	5029A	0.850	<b>R24</b>	<b>P25</b>
.937"	7242A	0.875	<b>R23</b>	<b>P24</b>
.975"	5028A	0.925	<b>R21</b>	<b>P22</b>
1.025"	7114A	0.975	<b>R19</b>	<b>P20</b>
1.175"	7088A	1.125	<b>R13</b>	<b>P14</b>
1.050"	3605	1.000	<b>R18</b>	<b>P19</b>
1.100"	5027A	1.050	<b>R16</b>	<b>P17</b>
1.150"	7104A	1.100	<b>R15</b>	<b>P15</b>
1.225"	875-K	1.175	<b>R11</b>	<b>P12</b>
1.275"	875-I	1.225	<b>R9</b>	<b>P10</b>
1.400"	D	1.350	<b>R4</b>	<b>P5</b>
1.500"	1500	1.450	---	<b>P1</b>



P29



R28

<sup>1</sup> Plain die bore diameter can be used as crimp spec  $\pm .005$

- dies for use with 5111A and 1765A ferrule machines. Other sizes are available.

## Manually - Operated Brass Ferrule Crimper

**Features:**

- crimps all brass ferrules shown on page 218
- does not include dies
- Dies for ferrule machines are available in standard sets for all ferrules as tabulated (4 segments to a set), supplied with plain or ribbed crimping surface
- height: 27" with handle upright
- base: 8" x 3"
- body: 7 $\frac{5}{8}$ "

---

 Part #

---

**5111A**

## Air Operated Brass Ferrule Crimper

**Features:**

- provides efficient mass production assembly of hose, ferrules, and fittings
- The foot pedal permits the use of both hands, reduces fatigue and speeds production.
- complete with air cylinder, ferrule machine (less dies), fitted hose lengths and necessary control valves
- ready for work bench installation
- crimps all brass ferrules shown on page 218

---

 Part #

---

**1765A**

Die sizes for ferrules and machine numbers 1765A and 5111A are on page 219.

## Small Hose Crimpers

**Features:**

- Hose crimper provides "big tool" crimping advantages at a fraction of the cost.
- rugged, portable and easy to use
- 855 crimper with 5 dies for 31/64" (0.484") to 45/64" (0.703") OD hose
- 855A crimper with 5 dies for 28/64" (0.437") to 43/64" (0.671") OD hose
- optional dies up to 52/64" OD available

Industrial Hose  
Fittings

Previous Part #	Part #
200FC	<b>855</b>
---	<b>855A</b>

## Small Hose Crimper Dies

Die Bore	Hose OD		Crimper # <b>855</b>	Crimper # <b>855A</b>	Previous Part #	Die Part #
	from	to				
.375"	.385"	.406"	optional	optional	200FC3	<b>856-10</b>
.437"	.447"	.468"	optional	standard	---	<b>856-7</b>
.484"	.490"	.520"	standard	standard	200FC4A	<b>856-4</b>
.531"	.540"	.562"	standard	standard	200FC4B	<b>856-3</b>
.578"	.590"	.625"	standard	standard	200FC5	<b>856-2</b>
.625"	.640"	.671"	standard	standard	200FC6A	<b>856-1</b>
.687"	.690"	.710"	standard	optional	200FC6B	<b>856-5</b>
.750"	.760"	.781"	optional	optional	200FC8A	<b>856-8</b>
.812"	.820"	.843"	optional	optional	200FC8B	<b>856-9</b>



D

## Large Hose Crimper

**Features:**

- for crimping ½" to 1" ID hoses with larger OD's, from 11/16" to 1½"
- crimps standard brass or aluminum ferrules
- order separate dies for each hose diameter
- **Dies sold separately**

Crimper Part #

**860**

## Crimper Dies

Hose OD/ Finished Crimp Dimension	Hose OD		Die Part #
	From	To	
11/16"	.687"	.765"	<b>861-22</b>
23/32"	.718"	.796"	<b>861-23</b>
3/4"	.750"	.828"	<b>861-24</b>
25/32"	.781"	.860"	<b>861-25</b>
13/16"	.812"	.890"	<b>861-26</b>
27/32"	.843"	.921"	<b>861-27</b>
7/8"	.875"	.953"	<b>861-28</b>
29/32"	.906"	.985"	<b>861-29</b>
15/16"	.937"	1.010"	<b>861-30</b>
31/32"	.968"	1.040"	<b>861-31</b>
1"	1.000"	1.070"	<b>861-32</b>
1-1/32"	1.031"	1.110"	<b>861-33</b>
1-1/16"	1.062"	1.114"	<b>861-34</b>
1-1/8"	1.125"	1.208"	<b>861-36</b>
1-3/16"	1.187"	1.265"	<b>861-38</b>
1-1/4"	1.250"	1.321"	<b>861-40</b>
1-5/16"	1.312"	1.390"	<b>861-42</b>
1-3/8"	1.375"	1.453"	<b>861-44</b>
1-7/16"	1.437"	1.551"	<b>861-46</b>
1-1/2"	1.500"	1.578"	<b>861-48</b>





Push-On Hose Barb Fittings



**Assembly Instructions:**

1. Trim hose end with smooth square cut
2. Lubricate either push-on fitting, hose or both.
3. Insert push-on fitting into hose until first barb is in hose.
4. Place end of fitting against a flat object (bench, wall, etc.) and grip the hose one inch from end. Push with a steady force until end of hose is covered by yellow plastic cap.

**Disassembly Instructions:**

1. Leaving push-on fitting in place, make a 1" cut in the hose along the barbed end of the fitting. Note: Be careful not to nick barbs when cutting the hose.
2. With firm grip on hose, give a sharp downward pull to release the fitting from the hose.

**intended for use with Lok-On (push-on style) hose only**

- No hose clamps or ferrules are needed for installation
- Properly grips push-on hose only when pushed all the way in, with the cut end of the hose completely concealed by the plastic cap.

**Male NPTF x Hose Barb**

- refer to page 226 for Push-On garden hose thread fittings
- optional package quantity

Hose ID	Male NPTF	Brass			Brass Cap Option		Lead Free Brass <sup>1,3</sup>	Pkg Qty
		Previous Part #	Part #	Pkg Qty	Part #	Pkg Qty		
1/4"	1/8"	BPN21	2720402C	100	2720402CBC	100	2720402CLF	100
	1/4"	BPN22	2720404C	100	2720404CBC	100	2720404CLF	100
	3/8"	BPN23	2720406C	50	2720406CBC	50	---	---
5/16"	1/8"	BPN251	2720502C	100	---	---	---	---
	1/4"	BPN252	2720504C	50	---	---	---	---
3/8"	1/8"	BPN31	2720602C	100	2720602CBC	100	---	---
	1/4"	BPN32	2720604C	50	2720604CBC	50	2720604CLF	50
	3/8"	BPN33	2720606C	50	2720606CBC	50	2720606CLF	50
	1/2"	BPN34	2720608C	25	2720608CBC	25	---	---
	3/4"	BPN36	2720612C	25	2720612CBC	25	---	---
1/2"	1/4"	BPN42	2720804C	25	2720804CBC	25	---	---
	3/8"	BPN43	2720806C	25	2720806CBC	25	2720806CLF	50
	1/2"	BPN44	2720808C	50	2720808CBC	50	2720808CLF	25
	3/4"	BPN46	2720812C	50	2720812CBC	50	---	---
5/8"	3/8"	BPN53	2721006C	25	2721006CBC	25	---	---
	1/2"	BPN54	2721008C	25	2721008CBC	25	---	---
	3/4"	BPN56	2721012C	25	2721012CBC	25	---	---
3/4"	1/2"	BPN64	2721208C	25	2721208CBC	25	---	---
	3/4"	BPN66	2721212C	25	2721212CBC	25	---	---
1"	3/4"	BPN86	2721612C	10	---	---	---	---
	1"	BPN88	2721616C <sup>2</sup>	10	---	---	---	---



brass



brass cap



303 stainless steel

Hose ID	Male NPT	303 Stainless Steel		Pkg Qty
		Previous Part #	Part #	
1/4"	1/8"	RPN21	2720402SS	100
	1/4"	RPN22	2720404SS	100
3/8"	1/4"	RPN32	2720604SS	50
	3/8"	RPN33	2720606SS	50
1/2"	1/4"	RPN42	2720804SS	25
	3/8"	RPN43	2720806SS	50
	1/2"	RPN44	2720808SS	25
3/4"	1/2"	RPN64	2721208SS	25
	3/4"	RPN66	2721212SS	20
1"	1"	RPN88	2721616SS <sup>2</sup>	5

<sup>1</sup> Lead free brass <=0.25% lead; Alloy CA2745; Alloy C46400

<sup>2</sup> capped

<sup>3</sup> NPT threads 272LF

**Male NPTF Swivel x Hose Barb**

Hose ID	Male NPTF	Brass		Pkg Qty
		Previous Part #	Part #	
1/4"	1/8"	271-0402	2710402C	100
	1/4"	271-0404	2710404C	50
3/8"	1/4"	271-0604	2710604C	50
	3/8"	271-0606	2710606C	50
1/2"	3/8"	271-0806	2710806C	25
	1/2"	271-0808	2710808C	20
3/4"	3/4"	271-1212	2711212C	10



- swivel is for assembly convenience only, not for live swivel applications, 120 PSI maximum

## Push-On Hose Barb Fittings

- **intended for use with Lok-On (push-on style) hose only**
- No hose clamps or ferrules are needed for installation
- Properly grips push-on hose only when pushed all the way in, with the cut end of the hose completely concealed by the plastic cap.



## Male NPTF x Hose Barb 90° Elbow



Hose ID	Male NPTF	Brass		Pkg Qty
		Previous Part #	Part #	
1/4"	1/8"-27	273-0402	<b>2730402C</b>	100
	1/4"-18	273-0404	<b>2730404C</b>	50
3/8"	1/8"-27	273-0602	<b>2730602C</b>	50
	1/4"-18	273-0604	<b>2730604C</b>	50
	3/8"-18	273-0606	<b>2730606C</b>	25
1/2"	3/8"-18	273-0806	<b>2730806C</b>	25
	1/2"-14	273-0808	<b>2730808C</b>	25
3/4"	1/2"-14	273-1208	<b>2731208C</b>	10
	3/4"-14	273-1212	<b>2731212C</b>	10

## Female NPTF x Hose Barb

- refer to page 226 for Push-On garden hose thread fittings

Hose ID	Female NPTF	Brass		Pkg Qty
		Previous Part #	Part #	
1/4"	1/8"	BPF21	<b>2740402C</b>	100
	1/8"	---	<b>2740402CBC</b> <sup>1</sup>	---
	1/4"	BPF22	<b>2740404C</b>	100
	1/4"	---	<b>2740404CBC</b> <sup>1</sup>	---
	3/8"	BPF23	<b>2740406C</b>	50
5/16"	3/8"	---	<b>2740406CBC</b> <sup>1</sup>	---
	1/8"	BPF251	<b>2740502C</b>	100
	1/4"	BPF252	<b>2740504C</b>	50
3/8"	1/8"	BPF31	<b>2740602C</b>	50
	1/8"	---	<b>2740602CBC</b> <sup>1</sup>	---
	1/4"	BPF32	<b>2740604C</b>	50
	1/4"	---	<b>2740604CBC</b> <sup>1</sup>	---
	3/8"	BPF33	<b>2740606C</b>	50
	3/8"	---	<b>2740606CBC</b> <sup>1</sup>	---
	1/2"	BPF34	<b>2740608C</b>	50
1/2"	3/4"	BPF36	<b>2740612C</b>	25
	1/4"	BPF42	<b>2740804C</b>	50
	1/4"	---	<b>2740804CBC</b> <sup>1</sup>	50
	3/8"	BPF43	<b>2740806C</b>	50
	3/8"	---	<b>2740806CBC</b> <sup>1</sup>	---
	1/2"	BPF44	<b>2740808C</b>	25
5/8"	1/2"	---	<b>2740808CBC</b> <sup>1</sup>	---
	3/4"	BPF46	<b>2740812C</b>	25
	3/4"	---	<b>2740812CBC</b> <sup>1</sup>	---
	3/8"	BPF53	<b>2741006C</b>	25
	1/2"	BPF54	<b>2741008C</b>	25
3/4"	1/2"	---	<b>2741008CBC</b> <sup>1</sup>	---
	3/4"	BPF56	<b>2741012C</b>	25
	3/4"	---	<b>2741012CBC</b> <sup>1</sup>	---
1"	1/2"	BPF64	<b>2741208C</b>	25
	3/4"	BPF66	<b>2741212C</b>	25
	3/4"	---	<b>2741212CBC</b> <sup>1</sup>	---
1"	3/4"	BPF86	<b>2741612C</b>	10
	1"	BPF88	<b>2741616C</b>	10

<sup>1</sup> brass cap on CBC parts

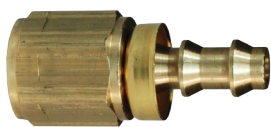

brass cap

Push-On Hose Barb Fittings

- **intended for use with Lok-On (push-on style) hose only**
- No hose clamps or ferrules are needed for installation
- Properly grips push-on hose only when pushed all the way in, with the cut end of the hose completely concealed by the plastic cap.



Female NPSM Swivel x Hose Barb Ball Seat

Hose ID	Female NPSM	Brass		Pkg Qty
		Previous Part #	Part #	
1/4"	1/8"	BPFS21	2780402C	100
	1/8"	---	2780402CBC <sup>1</sup>	100
	1/4"	BPFS22	2780404C	50
	1/4"	---	2780404CBC <sup>1</sup>	50
	3/8"	BPFS23	2780406C	50
	3/8"	---	2780406CBC <sup>1</sup>	50
3/8"	1/4"	BPFS32	2780604C	50
	1/4"	---	2780604CBC <sup>1</sup>	50
	3/8"	BPFS33	2780606C	50
	3/8"	---	2780606CBC <sup>1</sup>	50
1/2"	1/2"	BPFS34	2780608C	25
	1/2"	BPFS44	2780808C	50
	1/2"	---	2780808CBC <sup>1</sup>	50
1/2"	3/4"	BPFS46	2780812C	25
	3/4"	---	2780812CBC <sup>1</sup>	20
	3/4"	BPFS56	2781012C	20
5/8"	3/4"	---	2781212C	20
3/4"	3/4"	---	2781212CBC <sup>1</sup>	---



brass cap

<sup>1</sup> brass cap on CBC parts

Female NPSM Swivel x Hose Barb Gasket Seat

Hose ID	Female NPSM	Brass		Pkg Qty
		Previous Part #	Part #	
1/4"	1/8"	280-0402	2800402C	100
	1/8"	---	2800402CBC <sup>1</sup>	100
	1/4"	280-0404	2800404C	100
	1/4"	---	2800404CBC <sup>1</sup>	100
3/8"	1/4"	280-0604	2800604C	50
	1/4"	---	2800604CBC <sup>1</sup>	50
	3/8"	280-0606	2800606C	50
	3/8"	---	2800606CBC <sup>1</sup>	50
	1/2"	280-0608	2800608C	50
	1/2"	---	2800608CBC <sup>1</sup>	50
1/2"	1/2"	280-0808	2800808C	25
	1/2"	---	2800808CBC <sup>1</sup>	25
5/8"	1/2"	280-1008	2801008C	25
3/4"	3/4"	280-1212	2801212C	20
	3/4"	---	2801212CBC <sup>1</sup>	20

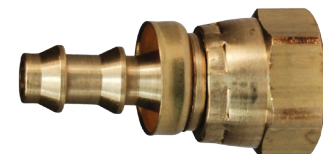

brass cap

<sup>1</sup> brass cap on CBC parts

- not recommended for use with water

Hose Menders

Hose ID	Brass		303 Stainless Steel		Pkg Qty
	Previous Part #	Part #	Previous Part #	Part #	
1/4"	BPM2	2960404C	SSPM2	2960404SS	100
	---	2960404CBC <sup>1</sup>	---	---	100
5/16"	BPM25	2960505C	---	---	100
3/8"	BPM3	2960606C	SSPM3	2960606SS	50
	---	2960606CBC <sup>1</sup>	---	---	50
1/2"	BPM4	2960808C	SSPM4	2960808SS	50
	---	2960808CBC <sup>1</sup>	---	---	50
5/8"	BPM5	2961010C	SSPM5	---	20
	---	2961010CBC <sup>1</sup>	---	---	20
3/4"	BPM6	2961212C	SSPM6	---	15
	---	2961212CBC <sup>1</sup>	---	---	15
1"	BPM8	2961616C	---	---	10



brass cap

<sup>1</sup> brass cap on CBC parts

- for Tuff-Lite™ hose menders in nylon and polypropylene see page 252

## Push-On Hose Barb Fittings

- **intended for use with Lok-On (push-on style) hose only**
- No hose clamps or ferrules are needed for installation
- Properly grips push-on hose only when pushed all the way in, with the cut end of the hose completely concealed by the plastic cap.



## Lok-On Male Garden Hose Fittings

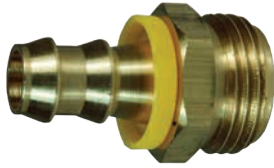

Hose ID	GHT Thread	Brass	
		Previous Part #	Part #
1/2"	3/4"	572-0812	<b>5720812C</b>
5/8"	3/4"	572-1012	<b>5721012C</b>
3/4"	3/4"	572-1212	<b>5721212C</b>

## Lok-On Female Swivel Garden Hose Fittings



Hose ID	GHT Thread	Brass	
		Previous Part #	Part #
1/2"	3/4"	574-0812	<b>5740812C</b>
5/8"	3/4"	574-1012	<b>5741012C</b>
3/4"	3/4"	574-1212	<b>5741212C</b>

## Lok-On Garden Hose Fitting Sets

## Feature:

- washer included, part # **5911212W** on page 242



Hose ID	GHT Thread	Brass	
		Previous Part #	Part #
1/2"	3/4"	575-0808	<b>5750808K</b>
5/8"	3/4"	575-1010	<b>5751010K</b>
3/4"	3/4"	575-1212	<b>5751212K</b>

## SAE Thread Size to UNF Thread Size Interchange

SAE Thread Number	SAE Tube OD	UNF Thread Size	SAE Thread Number	SAE Tube OD	UNF Thread Size
02	1/8"	5/16" - 24	07	7/16"	11/16" - 24
03	3/16"	3/8" - 24	08	1/2"	3/4" - 16
04	1/4"	7/16" - 20	10	5/8"	7/8" - 14
05	5/16"	1/2" - 20	12	3/4"	1-1/16" - 14
06	3/8"	5/8" - 18	---	---	---

## Male 45° SAE Swivel x Hose Barb



brass cap

Hose ID	Tube OD	Male UNF	Brass		Pkg Qty
			Previous Part #	Part #	
1/4"	1/4"	7/16"-20	282-0407	<b>2820407C</b>	100
	1/4"	7/16"-20	---	<b>2820407CBC<sup>2</sup></b>	100
	5/16"	1/2"-20	282-0408	<b>2820408C</b>	100
	5/16"	1/2"-20	---	<b>2820408CBC<sup>2</sup></b>	100
3/8"	3/8"	5/8"-18 <sup>1</sup>	282-0610	<b>2820610C</b>	50
	3/8"	5/8"-18 <sup>1</sup>	---	<b>2820610CBC<sup>2</sup></b>	100
1/2"	1/2"	3/4"-16	282-0812	<b>2820812C</b>	50
	1/2"	3/4"-16	---	<b>2820812CBC<sup>2</sup></b>	50
5/8"	5/8"	7/8"-14	282-1014	<b>2821014C</b>	25
	5/8"	7/8"-14	---	<b>2821014CBC<sup>2</sup></b>	25
3/4"	3/4"	1-1/16"-14 <sup>1</sup>	282-1217	<b>2821217C</b>	25
	3/4"	1-1/16"-14 <sup>1</sup>	---	<b>2821217CBC<sup>2</sup></b>	25

<sup>1</sup> notch in nut for SAE identification<sup>2</sup> brass cap on CBC parts

Push-On Hose Barb Fittings

- **intended for use with Lok-On (push-on style) hose only**
- No hose clamps or ferrules are needed for installation
- Properly grips push-on hose only when pushed all the way in, with the cut end of the hose completely concealed by the plastic cap.



**Female 45° SAE Swivel x Hose Barb**

- SAE thread size to UNF thread size interchange chart on previous page

Hose ID	Tube OD	Female UNF	Brass		Pkg Qty
			Previous Part #	Part #	
1/4"	3/8"	5/8"-18 <sup>1</sup>	284-0410	<b>2840410C</b>	50
	3/8"	5/8"-18 <sup>1</sup>	---	<b>2840410CBC<sup>2</sup></b>	---
5/16"	3/8"	5/8"-18 <sup>1</sup>	284-0510	<b>2840510C</b>	50
3/8"	3/8"	5/8"-18 <sup>1</sup>	284-0610	<b>2840610C</b>	100
	3/8"	5/8"-18 <sup>1</sup>	---	<b>2840610CBC<sup>2</sup></b>	---
3/4"	3/4"	1-1/16"-14 <sup>1</sup>	284-1217	<b>2841217C</b>	25
	3/4"	1-1/16"-14 <sup>1</sup>	---	<b>2841217CBC<sup>2</sup></b>	---



brass cap

<sup>1</sup> notch in nut for SAE identification

<sup>2</sup> brass cap on CBC parts

**JIC Thread Size to UNF Thread Size Interchange**

JIC Thread Number	JIC Tube OD	UNF Thread Size	JIC Thread Number	JIC Tube OD	UNF Thread Size
02	1/8"	5/16" - 24	12	3/4"	1-1/16" - 12
03	3/16"	3/8" - 24	14	7/8"	1-3/16" - 12
04	1/4"	7/16" - 20	16	1"	1-5/16" - 12
05	5/16"	1/2" - 20	20	1-1/4"	1-5/8" - 12
06	3/8"	9/16" - 18	24	1-1/2"	1-7/8" - 12
08	1/2"	3/4" - 16	28	1-3/4"	2-1/4" - 12
10	5/8"	7/8" - 14	32	2"	2-1/2" - 12

**Male 37° JIC x Hose Barb**

Hose ID	Tube OD	Male UNF	Brass		Pkg Qty
			Previous Part #	Part #	
1/4"	1/4"	7/16"-20	286-0407	<b>2860407C</b>	100
	1/4"	7/16"-20	---	<b>2860407CBC<sup>2</sup></b>	---
	5/16"	1/2"-20	286-0408	<b>2860408C</b>	50
	3/8"	9/16"-18	286-0409	<b>2860409C</b>	100
3/8"	3/8"	9/16"-18	---	<b>2860409CBC<sup>2</sup></b>	---
	3/8"	9/16"-18	286-0609	<b>2860609C</b>	50
1/2"	3/8"	9/16"-18	---	<b>2860609CBC<sup>2</sup></b>	---
	1/2"	3/4"-16	286-0812	<b>2860812C</b>	25
5/8"	1/2"	3/4"-16	---	<b>2860812CBC<sup>2</sup></b>	---
	5/8"	7/8"-14	286-1014	<b>2861014C</b>	25
3/4"	5/8"	7/8"-14	---	<b>2861014CBC<sup>2</sup></b>	---
	3/4"	1-1/16"-12	286-1217	<b>2861217C<sup>1</sup></b>	10
	3/4"	1-1/16"-12	---	<b>2861217CBC<sup>1,2</sup></b>	---



brass cap

<sup>1</sup> UN Thread

<sup>2</sup> brass cap on CBC parts

Push-On Hose Barb Fittings

- **intended for use with Lok-On (push-on style) hose only**
- No hose clamps or ferrules are needed for installation
- Properly grips push-on hose only when pushed all the way in, with the cut end of the hose completely concealed by the plastic cap.



Female 45°SAE/37°JIC Swivel x Hose Barb



plastic cap



brass cap



stainless steel

Hose ID	Tube OD	Female UNF	Brass			Lead Free Brass <sup>1</sup> Part #
			Previous Part #	Part #	Pkg Qty	
1/4"	1/4"	7/16"-20	287-0407	<b>2870407C</b>	100	<b>2870407CLF</b>
	1/4"	7/16"-20	---	<b>2870407CBC<sup>2</sup></b>	100	
	5/16"	1/2"-20	287-0408	<b>2870408C</b>	100	
	5/16"	1/2"-20	---	<b>2870408CBC<sup>2</sup></b>	---	
3/8"	5/16"	1/2"-20	287-0608	<b>2870608C</b>	25	---
	1/2"	3/4"-16	287-0612	<b>2870612C</b>	25	---
	1/2"	3/4"-16	---	<b>2870612CBC<sup>2</sup></b>	---	
1/2"	1/2"	3/4"-16	287-0812	<b>2870812C</b>	25	---
	1/2"	3/4"-16	---	<b>2870812CBC<sup>2</sup></b>	---	
	5/8"	7/8"-14	287-0814	<b>2870814C</b>	25	---
5/8"	5/8"	7/8"-14	---	<b>2870814CBC<sup>2</sup></b>	---	
	5/8"	7/8"-14	287-1014	<b>2871014C</b>	25	---
	5/8"	7/8"-14	---	<b>2871014CBC<sup>2</sup></b>	---	
3/4"	5/8"	7/8"-14	287-1214	<b>2871214C</b>	25	---
	5/8"	7/8"-14	---	<b>2871214CBC<sup>2</sup></b>	25	

Hose ID	Tube OD	Female UNF	Stainless Steel	
			Previous Part #	Part #
1/4"	1/4"	7/16"-20	287-0407SS	<b>2870407SS</b>
1/2"	1/2"	3/4"-16	287-0812SS	<b>2870812SS</b>

<sup>1</sup> lead free brass <=0.25% lead; Alloy CA2745; Alloy C46400

<sup>2</sup> brass cap on CBC parts

Female 37° JIC Swivel x Hose Barb



brass



303 stainless steel

Hose ID	Tube OD	Female UNF	Brass		Pkg Qty
			Previous Part #	Part #	
1/4"	3/8"	9/16"-18	288-0409	<b>2880409C</b>	50
	3/8"	9/16"-18	---	<b>2880409CBC<sup>1</sup></b>	50
5/16"	3/8"	9/16"-18	288-0509	<b>2880509C</b>	50
	3/8"	9/16"-18	288-0609	<b>2880609C</b>	50
3/8"	3/8"	9/16"-18	---	<b>2880609CBC<sup>1</sup></b>	100
	3/8"	9/16"-18	288-0809	<b>2880809C</b>	25
1/2"	3/4"	1-1/16"-12 <sup>2</sup>	288-1217	<b>2881217C</b>	10
	3/4"	1-1/16"-12 <sup>2</sup>	---	<b>2881217CBC<sup>1</sup></b>	10
1"	1"	1-5/16"-12 <sup>2</sup>	288-1621	<b>2881621C</b>	10

<sup>1</sup> brass cap on CBC parts

Hose ID	Tube OD	Female UNF	303 Stainless Steel	
			Previous Part #	Part #
3/8"	3/8"	9/16"-18	288-0609SS	<b>2880609SS</b>
3/4"	3/4"	1-1/16"-12 <sup>2</sup>	288-1217SS	<b>2881217SS</b>
1"	1"	1-5/16"-12 <sup>2</sup>	288-1621SS	<b>2881621SS</b>

<sup>2</sup> UN Thread

Female 37°JIC / 45° SAE Swivel x 90° Elbow



Hose ID	Tube OD	Female UNF	Plated Steel		Pkg Qty
			Previous Part #	Part #	
1/4"	1/4"	7/16"-20	289-0407	<b>2890407C<sup>2</sup></b>	25
	1/4"	7/16"-20	289-0407SAE	<b>2890407CSAE<sup>1</sup></b>	25
3/8"	3/8"	9/16"-18	289-0609	<b>2890609C<sup>2</sup></b>	25
	3/8"	5/8"-18	289-0610SAE	<b>2890610CSAE<sup>1</sup></b>	25
1/2"	1/2"	3/4"-16	289-0812	<b>2890812C<sup>2</sup></b>	10
	3/4"	1-1/16"-12 <sup>3</sup>	289-1217	<b>2891217C<sup>2</sup></b>	5

<sup>1</sup> notch in nut for SAE identification

<sup>2</sup> JIC only, may substitute dual angle

<sup>3</sup> UN thread

Push-On Hose Barb Fittings

- **intended for use with Lok-On (push-on style) hose only**
- No hose clamps or ferrules are needed for installation
- Properly grips push-on hose only when pushed all the way in, with the cut end of the hose completely concealed by the plastic cap.



Industrial Hose Fittings

**Male SAE Inverted Flare Swivel x Hose Barb**

Hose ID	Tube OD	Male UNF	Brass		Pkg Qty
			Previous Part #	Part #	
1/4"	3/16"	3/8"-24	290-0406	<b>2900406C</b>	100
	3/16"	3/8"-24	---	<b>2900406CBC<sup>2</sup></b>	100
	1/4"	7/16"-24 <sup>1</sup>	290-0407	<b>2900407C</b>	100
	1/4"	7/16"-24 <sup>1</sup>	---	<b>2900407CBC<sup>2</sup></b>	---
	5/16"	1/2"-20	290-0408	<b>2900408C</b>	100
	5/16"	1/2"-20	---	<b>2900408CBC<sup>2</sup></b>	---
5/16"	5/16"	1/2"-20	290-0508	<b>2900508C</b>	50
	3/8"	5/8"-18	290-0510	<b>2900510C</b>	50
3/8"	5/16"	1/2"-20	290-0608	<b>2900608C</b>	100
	5/16"	1/2"-20	---	<b>2900608CBC<sup>2</sup></b>	---
	3/8"	5/8"-18	290-0610	<b>2900610C</b>	50
1/2"	3/8"	5/8"-18	---	<b>2900610CBC<sup>2</sup></b>	---
	1/2"	3/4"-18 <sup>1</sup>	290-0812	<b>2900812C</b>	50
5/8"	1/2"	3/4"-18 <sup>1</sup>	---	<b>2900812CBC<sup>2</sup></b>	---
	5/8"	7/8"-18 <sup>1</sup>	290-1014	<b>2901014C</b>	25
	5/8"	7/8"-18 <sup>1</sup>	---	<b>2901014CBC<sup>2</sup></b>	---

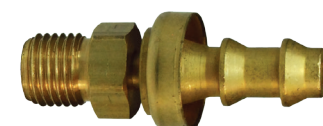

brass cap

<sup>1</sup> UNS thread

<sup>2</sup> brass cap on CBC parts

**Female SAE Inverted Flare Rigid x Hose Barb**

Hose ID	Tube OD	Female UNF	Brass		Pkg Qty
			Previous Part #	Part #	
1/4"	3/16"	3/8"-24	292-0406	<b>2920406C</b>	100
	3/16"	3/8"-24	---	<b>2920406CBC<sup>2</sup></b>	---
	1/4"	7/16"-24 <sup>1</sup>	292-0407	<b>2920407C</b>	100
	1/4"	7/16"-24 <sup>1</sup>	---	<b>2920407CBC<sup>2</sup></b>	---
	5/16"	1/2"-20	292-0408	<b>2920408C</b>	100
	5/16"	1/2"-20	---	<b>2920408CBC<sup>2</sup></b>	---
5/16"	5/16"	1/2"-20	292-0508	<b>2920508C</b>	100
	5/16"	1/2"-20	292-0608	<b>2920608C</b>	100
3/8"	5/16"	1/2"-20	---	<b>2920608CBC<sup>2</sup></b>	---
	3/8"	5/8"-18	292-0610	<b>2920610C</b>	50
	3/8"	5/8"-18	---	<b>2920610CBC<sup>2</sup></b>	---
1/2"	1/2"	3/4"-18 <sup>1</sup>	292-0812	<b>2920812C</b>	25
	1/2"	3/4"-18 <sup>1</sup>	---	<b>2920812CBC<sup>2</sup></b>	---



<sup>1</sup> UNS Thread

<sup>2</sup> brass cap on CBC parts

**Rigid Tube x Hose Barb**

Hose ID	Tube OD	Brass		303 Stainless Steel		Pkg Qty
		Previous Part #	Part #	Previous Part #	Part #	
1/4"	3/16"	294-0403	<b>2940403C</b>	---	---	100
	3/16"	---	<b>2940403CBC<sup>1</sup></b>	---	---	---
	1/4"	294-0404	<b>2940404C</b>	294-0404SS	<b>2940404SS</b>	100
	1/4"	---	<b>2940404CBC<sup>1</sup></b>	---	---	---
	5/16"	294-0405	<b>2940405C</b>	---	---	100
	5/16"	---	<b>2940405CBC<sup>1</sup></b>	---	---	---
3/8"	3/8"	294-0606	<b>2940606C</b>	294-0606SS	<b>2940606SS</b>	50
	3/8"	---	<b>2940606CBC<sup>1</sup></b>	---	---	---
1/2"	1/2"	294-0808	<b>2940808C</b>	294-0808SS	<b>2940808SS</b>	50
	1/2"	---	<b>2940808CBC<sup>1</sup></b>	---	---	---
5/8"	5/8"	294-1010	<b>2941010C</b>	---	---	25
	5/8"	---	<b>2941010CBC<sup>1</sup></b>	---	---	---
3/4"	3/4"	294-1212	<b>2941212C</b>	294-1212SS	<b>2941212SS</b>	25



<sup>1</sup> brass cap on CBC parts

## Push-On Fittings Tool

## Features:

- cuts push-on style hose and inserts the fitting
- Built-in cutter slices through 1/4" - 3/4" ID reinforced push-on hose without fraying.
- Clamp hose into tools vice and apply light pressure on handle to drive in the fitting.
- tool has four 7/16" diameter mounting holes for bench mounting
- overall size is 13 1/2" long x 2 3/8" wide x 7" height

## Installation Instructions:

1. To cut your hose, retract the handle, place the hose in the cutter area and pull the handle.
2. After cutting the hose to the desired length, place the hose under the cam handle locking it in place with the hose end aligned with the appropriate mark on the label.
3. Place the barbed end of the fitting against the end of the hose and then pull the handle forward to complete the installation.



Size	Part #
1/4" - 3/4"	<b>270AT</b>

 Caution: Push-on fittings will properly grip push-on hose only when pushed all the way in, with the cut end of the hose completely concealed by the plastic cap.

## Hose Assembly Tool

- installs 1/4", 5/16" and 3/8" hose fittings
- lightweight, portable, comfortable cushioned grip
- economical



Part #
<b>HHCI</b>

## Yellow Lok-on Caps

- **intended for use with Lok-On (push-on style) hose only**
- No hose clamps or ferrules are needed for installation
- Properly grips push-on hose only when pushed all the way in, with the cut end of the hose completely concealed by the plastic cap.



Hose ID	Plastic Part #	Pkg Qty
1/4"	<b>2720400W</b>	100
5/16"	<b>2720500W</b>	100
3/8"	<b>2720600W</b>	100
1/2"	<b>2720800W</b>	100
5/8"	<b>2721000W</b>	50
3/4"	<b>2721200W</b>	50
1"	<b>2721600W</b>	25

- Sold in package quantities only.



Reusable Fittings

**Application:**

- recommended for low pressure air hose applications

**Features:**

- maximum working pressure: **250 PSI** at ambient temperature **70°F (21°C)**
- durable, easily repaired hose connection
- *caution: check hose OD and ID accurately before ordering*



**Male Thread**

Hose ID	Hose OD	Male NPTF	Brass		Pkg Qty
			Previous Part #	Part #	
1/4"	1/2"	1/8"	BN21RU50	<b>1834082K</b>	100
	9/16"	1/8"	BN21RU56	<b>1834092K</b>	100
	5/8"	1/8"	BN21RU62	<b>1834102K</b>	100
	1/2"	1/4"	BN22RU50	<b>1834084K</b>	50
	9/16"	1/4"	BN22RU56	<b>1834094K</b>	50
	5/8"	1/4"	BN22RU62	<b>1834104K</b>	50
	1/2"	3/8"	BN23RU50	<b>1834086K</b>	50
	9/16"	3/8"	BN23RU56	<b>1834096K</b>	50
	5/8"	3/8"	BN23RU62	<b>1834106K</b>	50
5/16"	9/16"	1/4"	BN252RU56	<b>1835094K</b>	50
	5/8"	1/4"	BN252RU62	<b>1835104K</b>	50
	11/16"	1/4"	BN252RU68	<b>1835114K</b>	50
	9/16"	3/8"	BN253RU56	<b>1835096K</b>	50
	5/8"	3/8"	BN253RU62	<b>1835106K</b>	50
3/8"	11/16"	3/8"	BN253RU68	<b>1835116K</b>	50
	5/8"	1/4"	BN32RU62	<b>1836104K</b>	50
	11/16"	1/4"	BN32RU68	<b>1836114K</b>	50
	3/4"	1/4"	BN32RU75	<b>1836124K</b>	50
	5/8"	3/8"	BN33RU62	<b>1836106K</b>	50
	11/16"	3/8"	BN33RU68	<b>1836116K</b>	50
	3/4"	3/8"	BN33RU75	<b>1836126K</b>	50
	5/8"	1/2"	BN34RU62	<b>1836108K</b>	50
	11/16"	1/2"	BN34RU68	<b>1836118K</b>	50
1/2"	3/4"	1/2"	BN34RU75	<b>1836128K</b>	50
	7/8"	1/4"	BN42RU87	<b>1838144K</b>	25
	15/16"	1/4"	BN42RU93	<b>1838154K</b>	25
	1"	1/4"	BN42RU99	<b>1838164K</b>	25
	7/8"	3/8"	BN43RU87	<b>1838146K</b>	25
	15/16"	3/8"	BN43RU93	<b>1838156K</b>	25
	1"	3/8"	BN43RU99	<b>1838166K</b>	25
	7/8"	1/2"	BN44RU87	<b>1838148K</b>	20
	15/16"	1/2"	BN44RU93	<b>1838158K</b>	20
	1"	1/2"	BN44RU99	<b>1838168K</b>	20



Hose ID	Hose OD	Male NPT	303 Stainless Steel		Pkg Qty
			Previous Part #	Part #	
1/4"	1/2"	1/8"	BN21RU50SS	<b>1834082KSS</b>	100
	9/16"	1/8"	BN21RU56SS	<b>1834092KSS</b>	100
	5/8"	1/8"	BN21RU62SS	<b>1834102KSS</b>	100
	1/2"	1/4"	BN22RU50SS	<b>1834084KSS</b>	50
	9/16"	1/4"	BN22RU56SS	<b>1834094KSS</b>	50
	5/8"	1/4"	BN22RU62SS	<b>1834104KSS</b>	50
5/16"	9/16"	1/4"	BN252RU56SS	<b>1835094KSS</b>	50
	5/8"	1/4"	BN252RU62SS	<b>1835104KSS</b>	50
3/8"	5/8"	1/4"	BN32RU62SS	<b>1836104KSS</b>	50
	11/16"	1/4"	BN32RU68SS	<b>1836114KSS</b>	50
	3/4"	1/4"	BN32RU75SS	<b>1836124KSS</b>	50
	5/8"	3/8"	BN33RU62SS	<b>1836106KSS</b>	50
	11/16"	3/8"	BN33RU68SS	<b>1836116KSS</b>	50
	3/4"	3/8"	BN33RU75SS	<b>1836126KSS</b>	50
	7/8"	3/8"	BN43RU87SS	<b>1838146KSS</b>	25
	15/16"	3/8"	BN43RU93SS	<b>1838156KSS</b>	25
	7/8"	1/2"	BN44RU87SS	<b>1838148KSS</b>	20
	15/16"	1/2"	BN44RU93SS	<b>1838158KSS</b>	20



## Reusable Fittings

## Swivel Stems

Hose ID	Female NPSM	Brass Part #	Optional Qty
1/4"	1/4"-18	<b>1840404A</b>	50
	3/8"-18	<b>1840406A</b>	50
5/16"	1/4"-18	<b>1840504A</b>	50
3/8"	1/4"-18	<b>1840604A</b>	50
	3/8"-18	<b>1840606A</b>	50
1/2"	1/2"-14	<b>1840808A</b>	25

Industrial Hose Fittings



## Female Swivels

Hose ID	Hose OD	Female NPSM	Brass		Optional Qty
			Previous Part #	Part #	
1/4"	1/2"	1/4"	185-4084	<b>1854084K</b>	50
	9/16"	1/4"	185-4094	<b>1854094K</b>	50
	5/8"	1/4"	185-4104	<b>1854104K</b>	50
	1/2"	3/8"	185-4086	<b>1854086K</b>	50
	9/16"	3/8"	185-4096	<b>1854096K</b>	50
	5/8"	3/8"	185-4106	<b>1854106K</b>	50
5/16"	9/16"	1/4"	185-5094	<b>1855094K</b>	50
	5/8"	1/4"	185-5104	<b>1855104K</b>	50
	11/16"	1/4"	185-5114	<b>1855114K</b>	50
3/8"	5/8"	1/4"	185-6104	<b>1856104K</b>	50
	11/16"	1/4"	185-6114	<b>1856114K</b>	50
	3/4"	1/4"	185-6124	<b>1856124K</b>	50
	5/8"	3/8"	185-6106	<b>1856106K</b>	50
	11/16"	3/8"	185-6116	<b>1856116K</b>	50
	3/4"	3/8"	185-6126	<b>1856126K</b>	50
1/2"	7/8"	1/2"	185-8148	<b>1858148K</b>	20
	15/16"	1/2"	185-8158	<b>1858158K</b>	20
	1"	1/2"	185-8168	<b>1858168K</b>	20



## Splicer Stems

Hose ID	Brass Part #	Optional Qty
1/4"	<b>1860404S</b>	100
3/8"	<b>1860606S</b>	50



## Hose Splicers

Hose ID	Hose OD	Brass		Optional Qty
		Previous Part #	Part #	
1/4"	1/2"	187-0408	<b>1870408K</b>	50
	9/16"	187-0409	<b>1870409K</b>	50
	5/8"	187-0410	<b>1870410K</b>	50
3/8"	5/8"	187-0610	<b>1870610K</b>	25
	11/16"	187-0611	<b>1870611K</b>	25
	3/4"	187-0612	<b>1870612K</b>	25



Reusable Fittings

Industrial Hose  
Fittings

Ferrules

Hose ID	Hose OD	Brass Part #	303 Stainless Steel Part #	Opt Qty
1/4"	1/2"	<b>1800408F</b>	<b>1800408FSS</b>	100
	9/16"	<b>1800409F</b>	<b>1800409FSS</b>	50
	5/8"	<b>1800410F</b>	<b>1800410FSS</b>	50
5/16"	9/16"	<b>1800509F</b>	<b>1800509FSS</b>	100
	5/8"	<b>1800510F</b>	<b>1800510FSS</b>	50
	11/16"	<b>1800511F</b>	---	50
3/8"	5/8"	<b>1800610F</b>	<b>1800610FSS</b>	50
	11/16"	<b>1800611F</b>	<b>1800611FSS</b>	50
	3/4"	<b>1800612F</b>	<b>1800612FSS</b>	50
1/2"	7/8"	<b>1800814F</b>	<b>1800814FSS</b>	25
	15/16"	<b>1800815F</b>	<b>1800815FSS</b>	25
	1"	<b>1800816F</b>	---	20



Male Stems

Hose ID	Male NPTF Thread <sup>1</sup>	Brass Part #	303 Stainless Steel <sup>1</sup> Part #	Opt Qty
1/4"	1/8"	<b>1820402S</b>	<b>1820402SS</b>	100
	1/4"	<b>1820404S</b>	<b>1820404SS</b>	100
	3/8"	<b>1820406S</b>	---	50
5/16"	1/4"	<b>1820504S</b>	<b>1820504SS</b>	50
	3/8"	<b>1820506S</b>	---	50
3/8"	1/4"	<b>1820604S</b>	<b>1820604SS</b>	100
	3/8"	<b>1820606S</b>	<b>1820606SS</b>	50
	1/2"	<b>1820608S</b>	---	25
1/2"	1/4"	<b>1820804S</b>	---	50
	3/8"	<b>1820806S</b>	<b>1820806SS</b>	50
	1/2"	<b>1820808S</b>	<b>1820808SS</b>	25

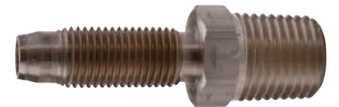
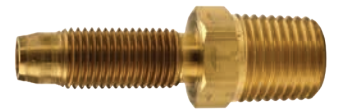

<sup>1</sup> stainless steel parts have NPT threads

## Standard Shank Fittings

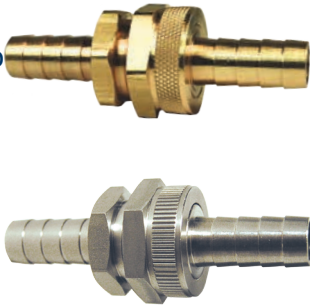

## GHT Complete Couplings with Hex Nut

## Feature:

- extended male GHT - deeper thread

Hose Size	Brass		Lead Free Brass <sup>2</sup> Part #	303 Stainless	
	Previous Part #	Part #		Previous Part #	Part #
3/8"	BC73	<b>5920606K</b>	---	---	---
1/2"	BC74	<b>5920808K</b>	<b>5920808KLF</b>	SSC74	<b>5920808KSS</b>
5/8"	BC75	<b>5921010K</b>	<b>5921010KLF</b>	SSC75	<b>5921010KSS</b>
3/4"	BC76	<b>5921212K</b>	<b>5921212KLF</b>	SSC76	<b>5921212KSS</b>
1"	BC78	<b>5921612K</b>	---	---	---
1"	BS808	<b>5921616K<sup>1</sup></b>	---	---	---

<sup>1</sup> 1" NPSH thread

<sup>2</sup> Lead free brass <=0.25% lead; Alloy CA2745; Alloy C46400

Note: complete coupling set is not shipped assembled

## GHT Female Fittings with Swivel Nut



Hose Size	Brass		Lead Free Brass <sup>2</sup> Part #	303 Stainless		Pkg Qty
	Previous Part #	Part #		Previous Part #	Part #	
3/8"	BCF73	<b>5910612C</b>	---	---	---	25
1/2"	BCF74	<b>5910812C</b>	---	SSCF74	<b>5910812SS</b>	25
	---	---	<b>5910812CLF</b>	---	---	25
5/8"	BCF75	<b>5911012C</b>	---	SSCF75	<b>5911012SS</b>	25
	---	---	<b>5911012CLF</b>	---	---	25
3/4"	BCF76	<b>5911212C</b>	---	SSCF76	<b>5911212SS</b>	25
	---	---	<b>5911212CLF</b>	---	---	25
1"	BCF78	<b>5911612C</b>	---	---	---	10
	BS848	<b>5911616C<sup>1,3</sup></b>	---	---	---	10

<sup>1</sup> 1" NPSH thread

<sup>2</sup> Lead free brass <=0.25% lead; Alloy CA2745; Alloy C46400

<sup>3</sup> washer included, part # **5911616W** on page 242

- SBR black rubber washer part # **5911212W** included found on page 242

## GHT Male Fittings

## Feature:

- extended male GHT - deeper thread



Hose Size	Brass		Lead Free Brass <sup>2</sup> Part #	303 Stainless		Pkg Qty
	Previous Part #	Part #		Previous Part #	Part #	
3/8"	BCM73	<b>5900612C</b>	---	---	---	25
1/2"	BCM74	<b>5900812C</b>	---	SSCM74	<b>5900812SS</b>	25
	---	---	<b>5900812CLF</b>	---	---	25
5/8"	BCM75	<b>5901012C</b>	---	SSCM75	<b>5901012SS</b>	25
	---	---	<b>5901012CLF</b>	---	---	25
3/4"	BCM76	<b>5901212C</b>	---	SSCM76	<b>5901212SS</b>	25
	---	---	<b>5901212CLF</b>	---	---	25
1"	BCM78	<b>5901612C</b>	---	---	---	10
	BS818	<b>5901616C<sup>1</sup></b>	---	---	---	<b>10</b>

<sup>1</sup> 1" NPSH thread

<sup>2</sup> Lead free brass <=0.25% lead; Alloy CA2745; Alloy C46400

## Short Shank Fittings

- use with washers on page 242

**GHT Complete Couplings with Hex Nut****Feature:**

- extended male GHT - deeper thread
- complete coupling set is not shipped assembled

Hose Size	Brass	
	Previous Part #	Part #
1/2"	HNBGH74	<b>5890808K</b>
5/8"	HNBGH75	<b>5891010K</b>
3/4"	HNBGH76	<b>5891212K</b>

**GHT Complete Couplings with Round Nut**

Hose Size	Brass	
	Previous Part #	Part #
1/2"	BGH74	<b>5870808K</b>
5/8"	BGH75	<b>5871010K</b>
3/4"	BGH76	<b>5871212K</b>

**GHT Female Couplings with Round Nut**

Hose Size	Shank Length	Brass	
		Previous Part #	Part #
1/2"	1"	BGHF74	<b>5860812C</b>
5/8"	1"	BGHF75	<b>5861012C</b>
3/4"	1"	BGHF76	<b>5861212C</b>

**GHT Female Swivels with Hex Nut**

Hose Size	Shank Length	Brass	
		Previous Part #	Part #
1/2"	1"	HNBGHF74	<b>5880812C</b>
5/8"	1"	HNBGHF75	<b>5881012C</b>
3/4"	1"	HNBGHF76	<b>5881212C</b>

**GHT Male Couplings with Hex****Feature:**

- extended male GHT - deeper thread

Hose Size	Shank Length	Brass	
		Previous Part #	Part #
1/2"	1"	BGHM74	<b>5850812C</b>
5/8"	1"	BGHM75	<b>5851012C</b>
3/4"	1"	BGHM76	<b>5851212C</b>



Short Shank Couplings with Octagon Nut

- sold in complete sets only



Hose Size	Shank Length	Aluminum Part #
3/8"	13/16"	<b>ABC73</b>
3/4"	1-1/8"	<b>ABC76</b>

Standard Shank Cast Coupling with Hex Nut

- use with washers on page 205
- sold in complete sets only



Hose Size	Brass Part #
1/2"	<b>CBC74</b>
5/8"	<b>CBC75</b>
3/4"	<b>CBC76</b>
1"	<b>CBC88<sup>1</sup></b>

<sup>1</sup> NPSM thread

Garden Hose Menders



Hose ID	Brass	
	Previous Part #	Part #
1/2"	5780808C	<b>1780808C</b>
5/8"	5781010C	<b>1781010C</b>
3/4"	5781212C	<b>1781212C</b>
1"	5781616C	<b>1781616C</b>

## Long Shank Fittings

## Complete Couplings - GHT

## Feature:

- extended male GHT, deeper thread

Hose ID	GHT Thread	Plated Steel Part #	Brass	
			Previous Part #	Part #
3/8"	3/4"	<b>SLS307</b>	---	---
1/2"	3/4"	<b>SLS407</b>	BLS407	<b>5950808K</b>
5/8"	3/4"	<b>SLS507</b>	BLS507	<b>5951010K</b>
3/4"	3/4"	<b>SLS607</b>	BLS607	<b>5951212K</b>



Industrial Hose Fittings

## Female Couplings - GHT

Hose ID	GHT Thread	Plated Steel Part #	Brass		Pkg Qty	Lead Free Brass Part #
			Previous Part #	Part #		
3/8"	3/4"	<b>SLS347</b>	---	---	---	---
1/2"	3/4"	<b>SLS447</b>	BLS447	<b>5940812C</b>	25	---
5/8"	3/4"	<b>SLS547</b>	BLS547	<b>5941012C</b>	25	---
3/4"	3/4"	<b>SLS647</b>	BLS647	<b>5941212C</b>	25	<b>5941212CLF<sup>1</sup></b>

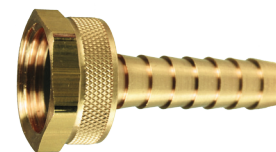

D

## Male Couplings - GHT

## Feature:

- extended male GHT, deeper thread

Hose ID	GHT Thread	Plated Steel Part #	Brass		Pkg Qty	Lead Free Brass Part #
			Previous Part #	Part #		
3/8"	3/4"	<b>SLS317</b>	---	---	50	---
1/2"	3/4"	<b>SLS417</b>	BLS417	<b>5930812C</b>	25	---
5/8"	3/4"	<b>SLS517</b>	BLS517	<b>5931012C</b>	25	---
3/4"	3/4"	<b>SLS617</b>	BLS617	<b>5931212C</b>	10	<b>5931212CLF<sup>1</sup></b>



<sup>1</sup> Lead free brass <=0.25% lead; Alloy CA2745; Alloy C46400

## Spray Hose Fittings

## Complete Couplings - GHT



Hose ID	GHT Thread	Plated Steel Part #
3/8"	3/4"	<b>SS307</b>
1/2"	3/4"	<b>SS407</b>
5/8"	3/4"	<b>SS507</b>
3/4"	3/4"	<b>SS607</b>

## Female Couplings - GHT



Hose ID	GHT Thread	Plated Steel Part #
3/8"	3/4"	<b>SS347</b>
1/2"	3/4"	<b>SS447</b>
5/8"	3/4"	<b>SS547</b>
3/4"	3/4"	<b>SS647</b>

## Male Couplings - GHT



Hose ID	GHT Thread	Plated Steel Part #
3/8"	3/4"	<b>SS317</b>
1/2"	3/4"	<b>SS417</b>
5/8"	3/4"	<b>SS517</b>
3/4"	3/4"	<b>SS617</b>



GHT Zinc Fittings

Features:

- premium brass and zinc construction for maximum strength and durability
- patented impact resistant clamp design
- non-corroding high grade 410 stainless steel screws will not strip when tightened
- leakproof, reusable
- for use with rubber or plastic hose
- fits all 5/8" and 3/4" hose

Female Hose Fittings

Part #	Optional Qty
<b>M5834F</b>	48



Male Hose Fittings

Part #	Optional Qty
<b>M5834M</b>	48



Menders

Part #	Optional Qty
<b>M5834HM</b>	48



Male GHT Adapters

Male Hose x Male Hose x Female Pipe

Male GH x Male GH x Female NPT	Lead Free Brass Part #
3/4" x 3/4" x 1/2"	<b>5091212CLF</b>



Male GHT x Male NPTF



brass



lead free brass



303 stainless

Male GHT	Male NPTF	Brass		Lead Free Brass <sup>3</sup> Part #	Male Thread	303 Stainless		Pkg Qty
		Previous Part #	Part #			Previous Part #	Part #	
3/4"	3/8"	BA73	<b>5081206C</b> <sup>1</sup>	---	---	---	---	25
3/4"	1/2"	BA74	<b>5081208C</b> <sup>1</sup>	<b>5081208CLF</b>	NPT	RA74	<b>5081208SS</b>	25
3/4"	3/4"	---	<b>5081212C</b> <sup>1</sup>	---	NPT	RA776	<b>5081212SS</b>	25
3/4"	3/4" x 1/2"	BA776	<b>5141212C</b> <sup>1,2</sup>	<b>5141212CLF</b> <sup>2</sup>	NPT	---	<b>5141212SS</b> <sup>2</sup>	25
3/4"	1"	BA78	<b>5081216C</b> <sup>1</sup>	---	---	---	---	10

<sup>1</sup> extended male GHT, deeper thread

<sup>2</sup> has 1/2" female NPT on ID of 3/4" male NPT side

<sup>3</sup> Lead free brass <=0.25% lead; Alloy CA2745; Alloy C46400

## Male GHT Adapters

## Male GHT



brass



303 stainless

Male GHT	Male GHT	Brass		Male GHT	303 Stainless		Pkg Qty
		Previous Part #	Part #		Previous Part #	Part #	
3/4"	3/4"	BA777	<b>5091212C</b> <sup>1</sup>	NPT	RA777	<b>5091212SS</b> <sup>1</sup>	25
3/4"	1" <sup>2</sup>	509-1612	<b>5091612C</b> <sup>1</sup>	---	---	---	20

<sup>1</sup> extended male GHT, deeper thread

<sup>2</sup> NPSH thread

## Female NPTF



brass



303 stainless

Male GHT	Female NPTF	Brass		Lead Free Brass Part #	Pkg Qty
		Previous Part #	Part #		
3/4"	1/4"	507-1204 <sup>1</sup>	<b>5071204C</b>	---	25
3/4"	3/8"	507-1206 <sup>1</sup>	<b>5071206C</b>	---	25
3/4"	1/2"	BA794 <sup>1</sup>	<b>5071208C</b>	---	25
3/4"	3/4"	BA796 <sup>1</sup>	<b>5071212C</b>	<b>5071212CLF</b> <sup>2,3</sup>	25

Male GHT	Female NPT	303 Stainless		Pkg Qty
		Previous Part #	Part #	
3/4"	1/2"	RA794	<b>5071208SS</b>	25
3/4"	3/4"	RA796	<b>5071212SS</b>	25

<sup>1</sup> extended male GHT, deeper thread

<sup>2</sup> NPT threads

<sup>3</sup> Lead free brass <=0.25% lead; Alloy CA2745; Alloy C46400

## Female GHT Adapters

## Swivel

Female x Female	Brass		Optional Qty
	Previous Part #	Part #	
¾" x ¾"	BA977	<b>5061212C</b>	25
¾" x ¾"	---	<b>5061212CLF</b> <sup>1</sup>	25



brass



lead free brass

<sup>1</sup> Lead free brass <=0.25% lead; Alloy CA2745; Alloy C46400

## Female GHT Swivel x Female NPTF

Female GHT x Female NPTF	Brass		Lead Free Brass Part #	303 Stainless		Pkg Qty
	Previous Part #	Part #		Previous Part #	Part #	
¾" x ½"	BAS974	<b>5021208C</b>	<b>5021208CLF</b> <sup>1,2</sup>	RAS974	<b>5021208SS</b> <sup>2</sup>	25
¾" x ¾"	BAS976	<b>5021212C</b>	<b>5021212CLF</b> <sup>1,2</sup>	RAS976	<b>5021212SS</b> <sup>2</sup>	10



<sup>1</sup> Lead free brass <=0.25% lead; Alloy CA2745; Alloy C46400

<sup>2</sup> NPT threads

## Female GHT Swivel x Male NPTF

Female GHT	Male NPTF	Brass		Male NPT	303 Stainless		Pkg Qty
		Previous Part #	Part #		Previous Part #	Part #	
¾"	¼"	504-1204	<b>5041204C</b>	---	---	---	25
¾"	⅜"	504-1206	<b>5041206C</b>	---	---	---	25
¾"	½"	504-1208	<b>5041208C</b>	½"	R504-1208	<b>5041208SS</b>	25
¾"	¾"	504-1212	<b>5041212C</b>	¾"	R504-1212	<b>5041212SS</b>	20



## Rigid Female GHT x Male NPTF

Female GHT	Male Thread NPTF	Brass		Male Thread NPT	303 Stainless		Pkg Qty
		Previous Part #	Part #		Previous Part #	Part #	
¾"	⅜"	BMA973	<b>5031206C</b>	---	---	---	25
¾"	½"	BMA974	<b>5031208C</b>	½"	RMA974	<b>5031208SS</b>	25
¾"	¾"	BMA976	<b>5031212C</b> <sup>1</sup>	¾"	RMA976	<b>5031212SS</b> <sup>1</sup>	25



## Rigid Female GHT x Female NPTF

Female GHT	Female Thread NPTF	Brass		Female Thread NPT	303 Stainless		Pkg Qty
		Previous Part #	Part #		Previous Part #	Part #	
¾"	⅛"	BA971	<b>5011202C</b>	---	---	---	50
¾"	¼"	BA972	<b>5011204C</b>	---	---	---	25
¾"	⅜"	BA973	<b>5011206C</b>	---	---	---	25
¾"	½"	BA974	<b>5011208C</b>	½"	RA974	<b>5011208SS</b>	25
¾"	¾"	BA976	<b>5011212C</b>	¾"	RA976	<b>5011212SS</b>	25



<sup>1</sup> has ½" female NPTF on ID of ¾" male NPTF side

## Black SBR Washers



ID	OD	duro	Part #	Optional Qty
0.63"	1.00"	80	<b>5911212W</b>	100
0.86"	1.27"	60	<b>5911616W</b>	100

## Garden Hose Filter Washer



Description	FDA black 70a duro PVC		Optional Qty
	Previous Part #	Part #	
304 stainless steel mesh, FDA black 70a duro PVC	TVS7-30	<b>5911212F</b>	100

## Red Vinyl GHT Washer



red vinyl Part #	Optional Qty
<b>TVW7</b>	100

## White Rubber GHT Washer



white rubber (Styrene Butadiene) Part #	Optional Qty
<b>TRW7</b>	100

## Garden Hose Cap



Size	Brass		Optional Qty
	Previous Part #	Part #	
¾"	GHC7	<b>5131212C</b>	25

## Garden Hose Round Nut with Knurl



Size	Brass Part #
¾"	<b>5861012N</b>

## Garden Hose Hex Nut with Knurl



Size	Brass Part #
¾" GHT	<b>5911212N</b>
1" NPSH	<b>5911616N</b>

Compression Bibb Faucets

Features:

- rough brass finish
- nozzle end is GHT
- for water use only

Male NPT Inlet Size	Brass Part #
1/2"	<b>35-201-10</b>
3/4"	<b>35-202-10</b>



Industrial Hose Fittings

Garden Hose Quick Connect

Features:

- easy push-pull ring for long lasting and quick hose attachments
- maximum operating pressure: **150 PSI** at ambient temperature **70°F (21°C)**
- maximum temperature **140°F (60°C)**

Complete Assembly

Description	Brass		303 Stainless Steel	
	Previous Part #	Part #	Previous Part #	Part #
complete assembly	DGH7	<b>500QCK</b>	DGH7SS	<b>500QCKSS</b>
complete valved assembly	DGH7V	<b>500QCKV</b>	---	---



D

Female Couplers

Description	Brass		303 Stainless Steel	
	Previous Part #	Part #	Previous Part #	Part #
coupler	DGH7C	<b>500QCF</b>	DGH7CSS	<b>500QCFSS</b>
valved coupler-water shutoff	DGH7CV	<b>500QCFV</b>	---	---



Replacement Parts

Description	Part #
replacement rubber seal gasket for 500QCFV (DGH7CV)	<b>500QCFVSG</b>
replacement NBR O-ring for 500QCFV (DGH7CV)	<b>500QCFVOR</b>

Replacement Seal for 500QCF

Nitrile Butadiene Rubber	
Previous Part #	Part #
DGHW7	<b>500QCSG</b>



Male Plugs

Description	Brass		303 Stainless Steel	
	Previous Part #	Part #	Previous Part #	Part #
male plug	DGH7P	<b>500QCM</b>	DGH7PSS	<b>500QCMSS</b>



## Garden Hose Fittings

## Straight GHT Valve

**Features:**

- powder-coated zinc shut-off valve
- maximum temperature: **160°F (71°C)** (hot water)
- recommended usage: **100°F (38°C)**
- working pressure: **60 PSI**

Part #

**GHV**

## GHT Ball Valve

**Features:**

- forged brass
- maximum temperature: **140°F (60°C)** (hot water)
- working pressure: **100 PSI**

Part #

**500GHV**

## GHT Twin Valve

**Features:**

- powder-coated zinc with twin shut-off valves
- maximum temperature: **160°F (71°C)** (hot water)
- recommended usage: **100°F (38°C)**
- working pressure: **60 PSI**

Part #

**GHYV**

## Garden Hose Y Valve

**Features:**

- forged brass
- double Y valve, swivel inlet - with Higbie cut threads (capped) to prevent cross threading
- maximum temperature: **140°F (60°C)** (hot water)
- working pressure: **100 PSI**

Part #

**500GHY**

## Garden Hose Y Coupler

**Features:**

- nickel plated brass
- maximum working pressure: **150 PSI**
- maximum temperature: **195°F (90.5°C)**

Part #

**500YC**

## GHT Y

**Features:**

- powder-coated zinc with twin outlet
- includes one end cap
- maximum temperature: **160°F (71°C)** (hot water)
- recommended usage: **100°F (38°C)**
- working pressure: **60 PSI**

Part #

**GHY**

## GHT 4-Valve Manifold

**Features:**

- forged brass body, stainless steel balls, PTFE seals
- swivel inlet
- maximum temperature: **120°F (49°C)**
- maximum operating pressure: **100 PSI**



Part #

**500GH4VBK**

## GHT Back Flow Preventer

**Features:**

- brass extruded stock
- maximum operating pressure: **125 PSI**
- temperature range: **33°F to 180°F (.5°C to 82°C)**

**Materials:**

- gasket: Buna-N
- components: stainless steel



Part #

**500BFP**

## Radiator Bibb

**Feature:**

- ¼" female pipe thread connection

**Material:**

- vinyl spout



Part #

**8013**

## Garden Hose Gooseneck

**Features:**

- angles hose away from hose bibb
- recommended usage: **100°F (38°C)**
- working pressure: **60 PSI**



Powder Coated Zinc

Part #

**GHGN**



Hose Shank x Male NPT Inserts

Size	Nylon Part #	Pkg Qty	Polypropylene Part #	Pkg Qty
1 1/4"	<b>THN15</b>	25	---	---
1 1/2"	<b>THN20</b>	25	<b>HB150</b>	25
2"	<b>THN25</b>	20	<b>HB200</b>	24
3"	<b>THN35</b>	10	<b>HB300</b>	10
4"	---	---	<b>HB400</b>	12

Tuff-Lite™

Hose Shank x Male NPT Insert

Nylon Features:

- Nylon fittings should not be used with acid-based fertilizers, bromine, chlorine, fluorine, hydrochloric acid, iodine, nitric acid, phosphoric acid, sulfuric acid or xylene.
- nylon should not be used with compressed gas 
- fittings are white

Polypropylene Features:

- Polypropylene fittings should not be used with aromatic hydrocarbons, carbon tetra-chloride, gasoline, hexane, kerosene, nitric acid, sodium hydrochlorite, toluene, trichloroethylene or xylene.
- polypropylene should not be used with compressed gas 
- fittings are black



Hose Size	Male NPT	Nylon Part #	Pkg Qty	Polypropylene Part #	Pkg Qty
1/4"	1/8"	<b>TN21</b>	50	<b>PPN21</b>	50
	1/4"	<b>TN22</b>	50	<b>PPN22</b>	50
	3/8"	<b>TN23</b>	50	<b>PPN23</b>	50
	1/2"	<b>TN24</b>	50	<b>PPN24</b>	50
	3/4"	<b>TN26</b>	50	---	---
	1"	<b>TN28</b>	50	---	---
	5/16"	1/4"	<b>TN252</b>	50	---
3/8"	1/8"	<b>TN31</b>	50	<b>PPN31</b>	50
	1/4"	<b>TN32</b>	50	<b>PPN32</b>	50
	3/8"	<b>TN33</b>	50	<b>PPN33</b>	50
	1/2"	<b>TN34</b>	50	<b>PPN34</b>	50
	3/4"	<b>TN36</b>	50	<b>PPN36</b>	50
1/2"	1/8"	<b>TN41</b>	50	---	---
	1/4"	<b>TN42</b>	50	<b>PPN42</b>	50
	3/8"	<b>TN43</b>	50	<b>PPN43</b>	50
	1/2"	<b>TN44</b>	50	<b>PPN44</b>	50
	3/4"	<b>TN46</b>	50	<b>PPN46</b>	50
5/8"	3/8"	<b>TN53</b>	50	---	---
	1/2"	<b>TN54</b>	50	<b>PPN54</b>	50
	3/4"	<b>TN56</b>	50	<b>PPN56</b>	50
3/4"	3/8"	<b>TN63</b>	50	---	---
	1/2"	<b>TN64</b>	50	<b>PPN64</b>	50
	3/4"	<b>TN66</b>	50	<b>PPN66</b>	50
	1"	<b>TN68</b>	25	<b>PPN68</b>	25
1"	3/4"	<b>TN86</b>	25	<b>PPN86</b>	25
	1"	<b>TN88</b>	25	<b>PPN88</b>	25
1 1/4"	1"	<b>TN158</b>	15	---	---
	1 1/4"	<b>TN150</b>	10	<b>PPN150</b>	10
	1 1/2"	<b>TN1520</b>	10	---	---
1 1/2"	1 1/4"	<b>TN2015</b>	10	---	---
	1 1/2"	<b>TN200</b>	10	<b>PPN200</b>	10
2"	2"	<b>TN250</b>	5	<b>PPN250</b>	5

• sold in package quantities only



Tuff-Lite™

Hose Shank x Female NPT Insert

Features:

- Nylon fittings should not be used with acid-based fertilizers, bromine, chlorine, fluorine, hydrochloric acid, iodine, nitric acid, phosphoric acid, sulfuric acid or xylene.
- nylon should not be used with compressed gas 

Hose Size	Female NPT	Nylon Part #
1/4"	1/4"	<b>TFS22</b>
1/4"	1/2"	<b>TFS42</b>
1/2"	1/2"	<b>TFS44</b>
3/4"	3/4"	<b>TFS66</b>



Female 45°SAE/37°JIC Swivel x Hose Barb

Feature:

- ball seat type

Hose Size	Female NPSM	Nylon Part #
1/4"	1/4"	<b>TF22</b>
3/8"	3/8"	<b>TF33</b>



Short Shank x Female NPSM Coupling

- sold in package quantities only
- shipped with a red vinyl washer (**TVW7**), replacement washers on page 242

Hose Shank	Female NPSM	Nylon Part #	Pkg Qty
1/4"	3/4"	<b>TCF62</b>	50
3/8"	3/4"	<b>TCF63</b>	50
1/2"	3/4"	<b>TCF64</b>	50
5/8"	3/4"	<b>TCF65</b>	50
3/4"	3/4"	<b>TCF66</b>	50



## Tuff-Lite™

## 90° Hose Barb Elbow x Male NPT



Hose Size	Male NPT	Nylon Part #	Pkg Qty
1/4"	1/8"	<b>TLS21</b>	50
	1/4"	<b>TLS22</b>	50
	3/8"	<b>TLS23</b>	50
3/8"	1/8"	<b>TLS31</b>	50
	1/4"	<b>TLS32</b>	50
	3/8"	<b>TLS33</b>	50
	1/2"	<b>TLS34</b>	50
	3/4"	<b>TLS36</b>	50
1/2"	1/4"	<b>TLS42</b>	50
	3/8"	<b>TLS43</b>	50
	1/2"	<b>TLS44</b>	50
	3/4"	<b>TLS46</b>	25
	1"	<b>TLS48</b>	25
5/8"	3/8"	<b>TLS53</b>	25
	1/2"	<b>TLS54</b>	25
	3/4"	<b>TLS56</b>	25
	1"	<b>TLS58</b>	25
3/4"	3/8"	<b>TLS63</b>	25
	1/2"	<b>TLS64</b>	25
	3/4"	<b>TLS66</b>	25
	1"	<b>TLS68</b>	15
1"	3/4"	<b>TLS86</b>	15
	1"	<b>TLS88</b>	15

- sold in package quantities only.

## 90° Hose Barb Elbow x Female NPT



Hose Size	Female NPT	Nylon Part #
1/2"	1/2"	<b>TLFS44</b>
1/2"	3/4"	<b>TLFS64</b>
3/4"	3/4"	<b>TLFS66</b>

## Hose Barb x 90° Hose Barb Elbow



Hose Size	Nylon Part #	Pkg Qty	Polypropylene Part #	Pkg Qty
1/4"	<b>TLSS22</b>	50	<b>PPLSS22</b>	50
3/8"	<b>TLSS33</b>	50	<b>PPLSS33</b>	50
1/2"	<b>TLSS44</b>	50	<b>PPLSS44</b>	50
3/4"	<b>TLSS66</b>	50	<b>PPLSS66</b>	50

- sold in package quantities only

Tuff-Lite™

Hose Run x Male NPT Branch Tee

Hose Size	Male NPT	Nylon Part #	Pkg Qty
1/4"	1/4"	<b>TSST222</b>	50
3/8"	3/8"	<b>TSST333</b>	50
1/2"	1/2"	<b>TSST444</b>	25
3/4"	3/4"	<b>TSST666</b>	25



Industrial Hose Fittings

- sold in package quantities only

Hose Run x Hose Branch Tee

Hose Size	Nylon Part #	Pkg Qty
1/4"	<b>TSSS222</b>	50
3/8"	<b>TSSS333</b>	50
1/2"	<b>TSSS444</b>	50
3/4"	<b>TSSS666</b>	25



D

- sold in package quantities only

Menders

Feature:

- maximum working temperature: 150°F (66°C)

Size	Nylon Part #	Pkg Qty	Polypropylene Part #	Pkg Qty
1/4"	<b>TM2</b> <sup>1</sup>	50	<b>PPM2</b>	50
5/16"	<b>TM25</b> <sup>1</sup>	50	---	---
3/8"	<b>TM3</b> <sup>1</sup>	50	<b>PPM3</b>	50
1/2"	<b>TM4</b> <sup>1</sup>	50	<b>PPM4</b>	50
5/8"	<b>TM5</b> <sup>1</sup>	50	<b>PPM5</b>	50
3/4"	<b>TM6</b> <sup>1</sup>	50	<b>PPM6</b>	50
1"	<b>TM8</b> <sup>1</sup>	25	<b>PPM8</b>	50
1 1/4"	<b>TM16</b>	50	---	---
1 1/2"	<b>TM21</b>	10	---	---
2"	<b>TM26</b>	20	---	---
4"	<b>TM46</b>	25	---	---
6"	<b>TM66</b>	12	---	---



nylon



polypropylene

- sold in package quantities only

Tuff-Lite™

Short Shank Female GHT Couplings



polypropylene



nylon

- shipped with a red vinyl washer (**TVW7**), replacement washers on page 242

Hose Shank	Thread Size	Nylon Part #	Polypropylene Part #
1/4"	3/4" GHT	<b>TCF72</b>	<b>PPCF72</b>
3/8"	3/4" GHT	<b>TCF73</b>	<b>PPCF73</b>
1/2"	3/4" GHT	<b>TCF74</b>	<b>PPCF74</b>
5/8"	3/4" GHT	<b>TCF75</b>	<b>PPCF75</b>
3/4"	3/4" GHT	<b>TCF76</b>	<b>PPCF76</b>

Short Shank Male GHT Couplings



polypropylene



nylon

Hose Shank	Thread Size	Nylon Part #	Polypropylene Part #
1/4"	3/4" GHT	<b>TCM72</b>	---
3/8"	3/4" GHT	<b>TCM73</b>	<b>PPCM73</b>
1/2"	3/4" GHT	<b>TCM74</b>	<b>PPCM74</b>
5/8"	3/4" GHT	<b>TCM75</b>	<b>PPCM75</b>
3/4"	3/4" GHT	<b>TCM76</b>	<b>PPCM76</b>

Male GHT x Female NPT Adapter



polypropylene



nylon

Female NPT	Nylon Part #	Pkg Qty	Polypropylene Part #	Pkg Qty
1/4"	<b>TA792</b>	50	<b>PPA792</b>	50
3/8"	<b>TA793</b>	50	---	--
1/2"	<b>TA794</b>	50	<b>PPA794</b>	50
3/4"	<b>TA796</b>	50	<b>PPA796</b>	25

- sold in package quantities only

Female GHT x Male NPT Adapter



Male NPT	Nylon Part #	Pkg Qty
1/4"	<b>TA972</b>	50
3/8"	<b>TA973</b>	50
1/2"	<b>TA974</b>	50
3/4"	<b>TA976</b>	50

- sold in package quantities only

Tuff-Lite™  
Female GHT x Female NPT Adapter

Female NPT	Nylon Part #	Pkg Qty
1/2"	<b>TA974F</b>	50
3/4"	<b>TA976F</b>	50

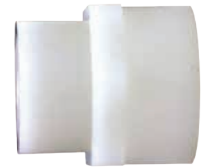

- sold in package quantities only

Male GHT x Male NPT Adapter

Male NPT	Nylon Part #	Pkg Qty	Polypropylene Part #	Pkg Qty
1/4"	<b>TA772</b>	50	---	---
3/8"	<b>TA773</b>	50	<b>PPA773</b>	50
1/2"	<b>TA774</b>	50	<b>PPA774</b>	50
3/4"	<b>TA776</b>	50	<b>PPA776</b>	50
1"	<b>TA778</b>	25	---	---



polypropylene



nylon

- sold in package quantities only

Male GHT x 90° Hose Barb Elbow

Hose Size	Nylon Part #	Pkg Qty
3/8"	<b>TLS37</b>	50
1/2"	<b>TLS47</b>	25
5/8"	<b>TLS57</b>	25
3/4"	<b>TLS67</b>	50



- sold in package quantities only

GHT x Male NPT Elbow

Male NPT	Nylon Part #	Pkg Qty
3/8"	<b>TLT73</b>	25
1/2"	<b>TLT74</b>	25
3/4"	<b>TLT76</b>	25



- sold in package quantities only

## Tuff-Lite™

Industrial Hose  
Fittings

## Push-On Hose Shank x Male NPT Insert

## Feature:

- No clamps are needed when these fittings are used with push-on hose.

Hose Size	Male NPT	Nylon Part #	Pkg Qty
1/4"	1/8"	<b>TPN21</b>	50
	1/4"	<b>TPN22</b>	50
	3/8"	<b>TPN23</b>	50
3/8"	1/4"	<b>TPN32</b>	50
	3/8"	<b>TPN33</b>	50
	1/2"	<b>TPN34</b>	50
1/2"	3/8"	<b>TPN43</b>	50
	1/2"	<b>TPN44</b>	50
	3/4"	<b>TPN46</b>	50

- sold in package quantities only

## Push-On Hose Shank x Female NPT Insert

## Feature:

- No clamps are needed when these fittings are used with push-on hose.



Hose Size	Female NPT	Nylon Part #	Pkg Qty
1/4"	1/4"	<b>TPF22</b>	50
3/8"	1/4"	<b>TPF32</b>	50
	3/8"	<b>TPF33</b>	50
1/2"	3/8"	<b>TPF43</b>	50
	1/2"	<b>TPF44</b>	50

- sold in package quantities only

## Push-On Hose Menders

## Feature:

- no clamps needed when used with push-on hose



Size	Nylon Part #	Pkg Qty
1/4"	<b>TPM2</b>	50
3/8"	<b>TPM3</b>	50
1/2"	<b>TPM4</b>	50

- sold in package quantities only

Type A

**Application:**

- used primarily on irrigation and suction lines

**Features:**

- hot dipped, galvanized
- has a double pin locking lever for smooth closing action
- Type A Agri-Lock style locks on female style
- Each coupler is equipped with a safety pin to prevent accidental openings.
- *These fittings are not recommended for chemicals or any hazardous type materials where the possibility of leakage would result in health or environmental concerns. Consult Dixon® for recommendations.*



**Female with Hose Shank**

**Feature:**

- supplied with gasket

Size	Galvanized Steel Part #
10"	<b>FC21210</b>
12"	<b>FC21212<sup>1</sup></b>

<sup>1</sup> 12" supplied with M20412 lever assist bar found on page 256



10"

**Female with Machined Hose Shank**

**Features:**

- Dixon® combination nipple style hose shank machined from Schedule 40 pipe
- recommended for use with steel King Crimp™ sleeves
- supplied with gasket

Size	Galvanized Steel Part #
10"	<b>FC21210ST100</b>
12"	<b>FC21212ST120<sup>1</sup></b>

<sup>1</sup> 12" supplied with M20412 lever assist bar found on page 256



12"

**Female with 150# ASA Flange**

**Feature:**

- supplied with gasket

Size	Galvanized Steel Part #
10"	<b>FC22310</b>
12"	<b>FC22312<sup>1</sup></b>

<sup>1</sup> 12" supplied with M20412 lever assist bar found on page 256

- For flange dimensions, diagrams and additional information please reference [dixonvalve.com](http://dixonvalve.com).



12"

## Type A

## Male with Hose Shank



Size	Galvanized Steel Part #
10"	<b>MC21110</b>
12"	<b>MC21112</b>

## Male with Machined Hose Shank

## Features:

- Dixon® combination nipple style hose shank machined from Schedule 40 pipe
- recommended for use with steel King Crimp™ sleeves



Size	Galvanized Steel Part #
10"	<b>MC21110ST100</b>
12"	<b>MC21112ST120</b>

## Male with 150# ASA Flange



Size	Galvanized Steel Part #
10"	<b>MC22210</b>
12"	<b>MC22212</b>

- For flange dimensions, diagrams and additional information please reference [dixonvalve.com](http://dixonvalve.com).



Type A

Male x Female 90° Elbows

Feature:

- supplied with gasket

Size	Galvanized Steel Part #
10"	<b>EL21510-90</b>
12"	<b>EL21512-90<sup>1</sup></b>



12"

<sup>1</sup> 12" supplied with M20412 lever assist bar on page 256

Industrial Hose Fittings

Female for Welding to Pipe

Size	Unplated Steel Part #
10"	<b>20410</b>
12"	<b>20412</b>



12"

Males with Ring for Welding

Size	Unplated Steel Part #
10"	<b>21010</b>
12"	<b>21012</b>



Female Plugs

Feature:

- supplied with gasket

Size	Galvanized Steel Part #
10"	<b>FP20910</b>
12"	<b>FP20912<sup>1</sup></b>



10"

<sup>1</sup> 12" supplied with M20412 lever assist bar on page 256

## Type A

## Male Plugs with Ring



Size	Galvanized Steel Part #
10"	<b>MP21010</b>
12"	<b>MP21012</b>

## Gaskets



Size	Rubber Part #	EPDM Part #
10"	<b>RG20510</b>	<b>RG20610</b>
12"	<b>RG20512</b>	<b>RG20612</b>

## Lever Assist Bar



Size	Galvanized Steel Part #
12"	<b>M20412</b>

## Quick Connect Safety Pin



Size	Galvanized Steel Part #
12"	<b>SP290</b>

Type B

**Application:**

- used primarily on irrigation and suction lines

**Features:**

- hot dipped, galvanized
- has a double pin locking lever for smooth closing action
- Type B (*Bauer style*) locks on the male side
- Each coupler is equipped with a safety pin to prevent accidental openings.
- *These fittings are not recommended for chemicals or any hazardous type materials where the possibility of leakage would result in health or environmental concerns. Consult Dixon® for recommendations.*



**Male x Hose Shank**

Size	Galvanized Steel Part #
2"	<b>MC3092</b>
3"	<b>MC3093</b>
4"	<b>MC3094</b>
6"	<b>MC3096</b>
8"	<b>MC3098</b>
10"	<b>MC30910</b> <sup>1</sup>
12"	<b>MC30912</b> <sup>1</sup>

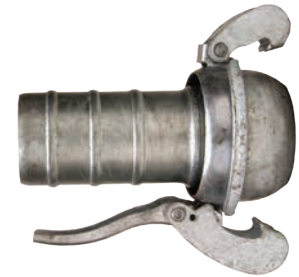

<sup>1</sup> 10" and 12" supplied with ACB304 lever assist bar on page 261

**Male with Male NPT**

Size	Galvanized Steel Part #
2"	<b>MCM3112</b>
3"	<b>MCM3113</b>
4"	<b>MCM3114</b>
6"	<b>MCM3116</b>
8"	<b>MCM3118</b>



**Female x Hose Shank**

**Feature:**

- supplied with gasket

Size	Galvanized Steel Part #
2"	<b>FC3102</b>
3"	<b>FC3103</b>
4"	<b>FC3104</b>
6"	<b>FC3106</b>
8"	<b>FC3108</b>
10"	<b>FC31010</b>
12"	<b>FC31012</b>



**Female with Male NPT**

**Feature:**

- supplied with gasket

Size	Galvanized Steel Part #
2"	<b>FCM3122</b>
3"	<b>FCM3123</b>
4"	<b>FCM3124</b>
6"	<b>FCM3126</b>
8"	<b>FCM3128</b>



## Type B

## Male with Machined Hose Shank

## Features:

- Dixon® combination nipple style hose shank machined from Schedule 40 pipe
- recommended for use with steel King Crimp™ sleeves



Size	Galvanized Steel Part #
2"	<b>MC3092ST25</b>
3"	<b>MC3093ST35</b>
4"	<b>MC3094ST40</b>
6"	<b>MC3096ST60</b>
8"	<b>MC3098ST80</b>

## Male x 150# ASA Flange



Size	Galvanized Steel Part #
4"	<b>MC3134</b>
6"	<b>MC3136</b>
8"	<b>MC3138</b>
10"	<b>MC31310</b> <sup>1</sup>
12"	<b>MC31312</b> <sup>1</sup>

<sup>1</sup> 10" and 12" supplied with ACB304 lever assist bar on page 261

- For flange dimensions, diagrams and additional information please reference [dixonvalve.com](http://dixonvalve.com).

## Male Weld-On



Size	Unplated Steel Part #
2"	<b>3032</b>
3"	<b>3033</b>
4"	<b>3034</b>
6"	<b>3036</b>
8"	<b>3038</b>
10"	<b>30310</b>
12"	<b>30312</b>

- female and male fittings are commonly used for butt-welding to pipe

## Heavy Duty Female x Dixon® Combination Nipple Hose Shank

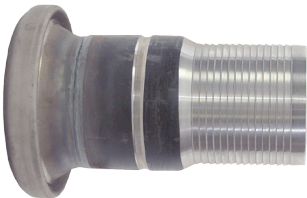

Size	Galvanized Steel Part #
2"	<b>FC3102ST25</b>
3"	<b>FC3103ST35</b>
4"	<b>FC3104ST40</b>
6"	<b>FC3106ST60</b>
8"	<b>FC3108ST80</b>

Type B  
Female x 150# ASA Flange

**Feature:**

- supplied with gasket

Size	Galvanized Steel Part #
4"	<b>FC3144</b>
6"	<b>FC3146</b>
8"	<b>FC3148</b>
10"	<b>FC31410</b>
12"	<b>FC31412</b>



- For flange dimensions, diagrams and additional information please reference dixonvalve.com.

Female Weld-On with Gasket

**Feature:**

- supplied with gasket

Size	Unplated Steel Part #
2"	<b>3022</b>
3"	<b>3023</b>
4"	<b>3024</b>
6"	<b>3026</b>
8"	<b>3028</b>
10"	<b>30210</b>
12"	<b>30212</b>



Male x Female 90° Elbow

**Feature:**

- supplied with gasket

Size	Galvanized Steel Part #
4"	<b>EL3154-90</b>
6"	<b>EL3156-90</b>
8"	<b>EL3158-90</b>
10"	<b>EL31510-90<sup>1</sup></b>
12"	<b>EL31512-90<sup>1</sup></b>



<sup>1</sup> 10" and 12" supplied with ACB304 lever assist bar on page 261

Male x Female 45° Elbow

**Feature:**

- supplied with gasket

Size	Galvanized Steel Part #
4"	<b>EL3154-45</b>
6"	<b>EL3156-45</b>
8"	<b>EL3158-45</b>
10"	<b>EL31510-45<sup>1</sup></b>
12"	<b>EL31512-45<sup>1</sup></b>



<sup>1</sup> 10" and 12" supplied with ACB304 lever assist bar on page 262

Type B

Female x Male Reducer

Feature:

- supplied with gasket



Female Size	Male Size	Galvanized Steel Part #
6"	4"	<b>FMR31864</b>
8"	6"	<b>FMR31886</b>
10"	8"	<b>FMR318108<sup>1</sup></b>
12"	10"	<b>FMR3181210<sup>1</sup></b>

<sup>1</sup> 10" and 12" supplied with ACB304 lever assist bar on page 261

Female x Male Increaser

Feature:

- supplied with gasket



Female Size	Male Size	Galvanized Steel Part #
4"	6"	<b>FMI31946</b>
6"	8"	<b>FMI31968</b>
8"	10"	<b>FMI319810</b>
10"	12"	<b>FMI3191012<sup>1</sup></b>

<sup>1</sup> 10" and 12" supplied with ACB304 lever assist bar on page 261

Male with Male NPT- extra long

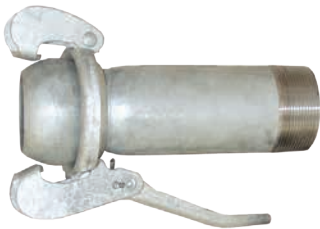

Size	Galvanized Steel Part #
2"	<b>MCM3112XL</b>
3"	<b>MCM3113XL</b>
4"	<b>MCM3114XL</b>
6"	<b>MCM3116XL</b>
8"	<b>MCM3118XL</b>

Male Plugs



Size	Galvanized Steel Part #
2"	<b>MP3232</b>
3"	<b>MP3233</b>
4"	<b>MP3234</b>
6"	<b>MP3236</b>
8"	<b>MP3238</b>
10"	<b>MP32310<sup>1</sup></b>
12"	<b>MP32312<sup>1</sup></b>

<sup>1</sup> 10" and 12" supplied with ACB304 lever assist bar on page 261

Type B  
Female Plugs

Feature:

- supplied with gasket

Size	Galvanized Steel Part #
2"	<b>FP3082</b>
3"	<b>FP3083</b>
4"	<b>FP3084</b>
6"	<b>FP3086</b>
8"	<b>FP3088</b>
10"	<b>FP30810</b>
12"	<b>FP30812</b>



Lever Rings

Size	Galvanized Steel Part #
2"	<b>LR3042</b>
3"	<b>LR3043</b>
4"	<b>LR3044</b>
6"	<b>LR3046</b>
8"	<b>LR3048</b>
10"	<b>LR30410</b>
12"	<b>LR30412</b>



Lever Assist Bar

Size	Description	Galvanized Steel Part #
10" & 12"	lever assist bar for 10" and 12" Type B fittings	<b>ACB304</b>



Gaskets

Size	Rubber Part #	EPDM Part #
2"	<b>RG3052</b>	<b>RG3062</b>
3"	<b>RG3053</b>	<b>RG3063</b>
4"	<b>RG3054</b>	<b>RG3064</b>
6"	<b>RG3056</b>	<b>RG3066</b>
8"	<b>RG3058</b>	<b>RG3068</b>
10"	<b>RG30510</b>	<b>RG30610</b>
12"	<b>RG30512</b>	<b>RG30612</b>



Quick Connect Safety Clips

Size	Galvanized Steel Part #
2"	<b>SP59</b>
3"	<b>SP76</b>
4"	<b>SP89</b>
6"	<b>SP159</b>
8"	<b>SP159</b>
10"	<b>SP390</b>
12"	<b>SP390</b>

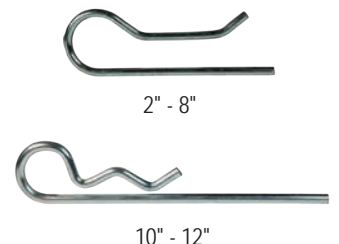

## Band & Worm Gear Clamps ... 263 to 275

Dixon® HS and HSS styles .....	263
Miniature MH and MAH styles .....	263
Aero-Seal® style.....	264
Marine grade .....	264
Aero-Seal® style line .....	265
WaveSeal .....	265
Constant torque .....	266
HTM hi torque.....	266
Center punch.....	267
Pre-formed F series .....	267
Open end FO series.....	267
Universal pre-formed, K series .....	268
Dixon® smooth ID .....	269
Roll-over type.....	269
Center punch .....	269
Band and buckle.....	270
Clamp buckles .....	270
Strapping.....	270
Set screw buckles .....	270
Banding.....	270
Band clamp tools .....	271 to 272
Portable locking hand tool.....	271
Intermediate hand tool .....	271
Hand tool for 5/8" clamps.....	271
Hand tool for 3/8" and 5/8" clamps .....	271
Adapter for F100 tool .....	271
Hand tool for K clamps.....	272
Punching mallet .....	272
Clamp cutter.....	272
Clamping tool for band and buckles .....	272
Band and buckle clamping tool .....	272
Clamping tool adapter for 51960 tool.....	272
Pinch-on single ear.....	273
Pinch-on double ear .....	273
Stepless® ear .....	274
Clamp service kit .....	274
Standard jaw clamp tool .....	274
Side jaw clamp tool.....	274
Dixon® worm gear clamp racks .....	275
Quick release.....	275
Make-A-Clamp kits .....	275

## Bolted Clamps ..... 276 to 281

TBC and STBC style T-bolt .....	276
Heavy duty T-bolt.....	277
Long T-bolt.....	278
Double bolt .....	279
With saddles .....	279
Single bolt.....	280

## Bolted Clamps (cont.) ..... 276 to 281

Spiral clamps .....	281
Clockwise.....	281
Counterclockwise .....	281



Dixon® Worm Gear Clamps

Features:

- clamp meets SAEJ1508 which supercedes Mil Spec WW-C-440B
- four-piece construction
- screw design: 5/16" slotted hex head
- maximum recommended torque 50 in. lbs.
- **all clamps sold 10 per box**

Style HS material:

- band and housing: SAE 300 series stainless
- screw: SAE 1018 case-hardened, hex-free chrome zinc-plated steel

Style HSS material:

- band and housing: SAE 300 series stainless
- screw: SAE 300 series stainless

Band Width	Hose OD		style HS Part #	Master Case Qty	style HSS Part #	Master Case Qty	
	from	to					
1/2"	7/16"	25/32"	<b>HS6</b>	200	<b>HSS6</b>	200	
	1/2"	29/32"	<b>HS8</b>	200	<b>HSS8</b>	200	
	9/16"	1-1/16"	<b>HS10</b>	500	<b>HSS10</b>	500	
	11/16"	1-1/14"	<b>HS12</b>	500	<b>HSS12</b>	500	
	13/16"	1-1/2"	<b>HS16</b>	500	<b>HSS16</b>	500	
	13/16"	1-3/4"	<b>HS20</b>	500	<b>HSS20</b>	500	
	1-1/16"	2"	<b>HS24</b>	500	<b>HSS24</b>	500	
	1-5/16"	2-1/4"	<b>HS28</b>	500	<b>HSS28</b>	500	
	1-9/16"	2-1/2"	<b>HS32</b>	500	<b>HSS32</b>	500	
	1-13/16"	2-3/4"	<b>HS36</b>	500	<b>HSS36</b>	500	
	2-1/16"	3"	<b>HS40</b>	200	<b>HSS40</b>	200	
	2-5/16"	3-1/4"	<b>HS44</b>	200	<b>HSS44</b>	200	
	2-9/16"	3-1/2"	<b>HS48</b>	200	<b>HSS48</b>	200	
	2-13/16"	3-3/4"	<b>HS52</b>	200	<b>HSS52</b>	200	
	3-1/16"	4"	<b>HS56</b>	200	<b>HSS56</b>	200	
	3-5/16"	4-1/4"	<b>HS60</b>	200	<b>HSS60</b>	200	
	9/16"	3-9/16"	4-1/2"	<b>HS64</b>	200	<b>HSS64</b>	200
		1-7/8"	5"	<b>HS72</b>	100	<b>HSS72</b>	100
2-1/2"		5-1/2"	<b>HS80</b>	100	<b>HSS80</b>	100	
3-1/8"		6"	<b>HS88</b>	100	<b>HSS88</b>	100	
3-5/8"		6-1/2"	<b>HS96</b>	100	<b>HSS96</b>	100	
4-1/8"		7"	<b>HS104</b>	100	<b>HSS104</b>	100	
5-5/8"		8-1/2"	<b>HS128</b>	100	<b>HSS128</b>	100	
7-1/8"		10"	<b>HS152</b>	100	<b>HSS152</b>	100	
9-3/8"		12-1/4"	<b>HS188</b>	100	<b>HSS188</b>	100	
10-1/8"		13"	<b>HS200</b>	100	<b>HSS200</b>	100	
10-7/8"		13-3/4"	<b>HS212</b>	100	<b>HSS212</b>	100	
11-5/8"		14-1/2"	<b>HS224</b>	100	<b>HSS224</b>	100	
12-3/8"		15-1/4"	<b>HS236</b>	100	<b>HSS236</b>	100	
13-1/8"		16"	<b>HS248</b>	100	<b>HSS248</b>	100	
17-1/8"		20"	<b>HS312</b>	100	<b>HSS312</b>	100	



style HSS

Clamps



Miniature Worm Gear Clamps

Features:

- meets SAE J1508
- screw design: 1/4" slotted hex head
- maximum recommended torque 15 in. lbs.
- **all clamps sold 10 per box**

Style MH material:

- band and housing: SAE 300 series stainless
- screw: SAE 1018 case-hardened, hex-free chrome zinc-plated steel

Style MAH material:

- band and housing: SAE 300 series stainless
- screw: SAE 300 series stainless

Band Width	Hose OD		style MH Part #	Master Case Qty	style MAH Part #	Master Case Qty
	from	to				
5/16"	7/32"	5/8"	<b>MH4</b>	500	<b>MAH4</b>	500
	7/16"	25/32"	<b>MH6</b>	500	<b>MAH6</b>	500
	1/2"	29/32"	<b>MH8</b>	200	<b>MAH8</b>	200
	9/16"	1-1/16"	<b>MH10</b>	200	<b>MAH10</b>	200
	11/16"	1-1/4"	<b>MH12</b>	200	<b>MAH12</b>	200
	15/16"	1-1/2"	<b>MH16</b>	200	<b>MAH16</b>	200
	1-3/16"	1-3/4"	<b>MH20</b>	200	<b>MAH20</b>	200



style MH

Torque ratings correspond to the torque rating of the screw of the clamp and are not an indication of the working pressure of any hose assembly installed with this clamp. 

## Aero-Seal® Worm Gear Clamps

## Features:

- four-piece construction
- band slots designed for strength and smooth action
- saddle interlocks into embossed band to form a true concentric circle
- slotted hex head screw design
- heat treated screws have buttress thread type
- safety collar or thumb screw available on the style 200 series only
- suggested installation torque 30-42 inch pounds, maximum recommended torque 60 in. lbs.
- **all clamps sold 10 per box**
- Torque ratings correspond to the torque rating of the screw of the clamp and *are not an indication of the working pressure of any hose assembly installed with this clamp.* 

## Style 100:

- band and housing: 300 SS
- screw: plated carbon steel

## Style 200:

- band and housing: 300 SS
- screw: 410 stainless steel

## Style 300:

- band and housing: 300 SS
- screw: 305 stainless steel



style 300

Band Width	Hose OD		Style 100 Part #	Style 200 Part #	Style 300 Part #	Pkg Qty
	from	to				
9/16"	7/16"	25/32"	10006	20006	30006	10
	1/2"	29/32"	10008	20008	30008	10
	9/16"	1-1/16"	10010	20010	30010	10
	11/16"	1-1/4"	10012	20012	30012	10
	13/16"	1-1/2"	10016	20016	30016	10
	13/16"	1-3/4"	10020	20020	30020	10
	1-1/16"	2"	10024	20024	30024	10
	1-5/16"	2-1/4"	10028	20028	30028	10
	1-9/16"	2-1/2"	10032	20032	30032	10
	1-13/16"	2-3/4"	10036	20036	30036	10
	2-1/16"	3"	10040	20040	30040	10
	2-5/16"	3-1/4"	10044	20044	30044	10
	2-9/16"	3-1/2"	10048	20048	30048	10
	2-13/16"	3-3/4"	10052	20052	30052	10
	3-1/16"	4"	10056	20056	30056	10
	3-5/16"	4-1/4"	10060	20060	30060	10

## Marine Grade Worm Gear Clamps

## Features:

- three-piece construction
- clamp meets SAEJ1508 which supercedes Mil Spec WW-C-440B
- 316 stainless steel marine grade: band, screw, housing
- screw design: 5/16" slotted hex head
- suggested installation torque 30-42 inch pounds, maximum recommended torque 60 in. lbs.
- **all clamps sold 10 per box**
- Torque ratings correspond to the torque rating of the screw of the clamp and *are not an indication of the working pressure of any hose assembly installed with this clamp.* 



Band Width	Hose OD		316 Stainless Steel Part #
	from	to	
1/2"	3/8"	7/8"	MGC6
	7/16"	1"	MGC8
	9/16"	1-1/16"	MGC10
	9/16"	1-5/16"	MGC12
	11/16"	1-1/2"	MGC16
	3/4"	1-3/4"	MGC20
	1-1/16"	2"	MGC24
	1-5/16"	2-1/4"	MGC28
	1-9/16"	2-1/2"	MGC32
	1-13/16"	2-3/4"	MGC36
	2-11/16"	3"	MGC40
	2-5/16"	3-1/4"	MGC44
	2-9/16"	3-1/2"	MGC48
	2-13/16"	3-3/4"	MGC52
	3-1/16"	4"	MGC56
	2-1/2"	4-1/2"	MGC64
	3-1/16"	5"	MGC72
	3-1/2"	5-1/2"	MGC80
	4-3/32"	6"	MGC88
	4-1/2"	6-1/2"	MGC96
5"	7"	MGC104	

Aero-Seal® Liner Worm Gear Clamps

Features:

- The integral extension of the band as a liner (no rivets or welds) protects soft surface hose (silicone and others) from damage caused by extrusion or shearing through the band slots.
- screw design: 5/16" hex slotted hex head
- **all clamps sold 10 per box**
- band, saddle, housing: stainless steel

Style DL:

- screw: plated carbon steel

Style DLS:

- screw: 410 stainless steel

Band Width	Hose OD		style DL Part #	Pkg Qty	style DLS Part #	Pkg Qty
	from	to				
1/2"	7/16"	25/32"	<b>DL9206</b>	10	<b>DLS9406</b>	10
	1/2"	29/32"	<b>DL9208</b>	10	<b>DLS9408</b>	10
	9/16"	1-1/16"	<b>DL9210</b>	10	<b>DLS9410</b>	10
	11/16"	1-1/4"	<b>DL9212</b>	10	<b>DLS9412</b>	10
	13/16"	1-1/2"	<b>DL9216</b>	10	<b>DLS9416</b>	10
	13/16"	1-3/4"	<b>DL9220</b>	10	<b>DLS9420</b>	10
	1-1/16"	2"	<b>DL9224</b>	10	<b>DLS9424</b>	10
	1-5/16"	2-1/4"	<b>DL9228</b>	10	<b>DLS9428</b>	10
	1-9/16"	2-1/2"	<b>DL9232</b>	10	<b>DLS9432</b>	10
	1-13/16"	2-3/4"	<b>DL9236</b>	10	<b>DLS9436</b>	10
	2-1/16"	3"	<b>DL9240</b>	10	<b>DLS9440</b>	10
	2-5/16"	3-1/4"	<b>DL9244</b>	10	<b>DLS9444</b>	10
	2-9/16"	3-1/2"	<b>DL9248</b>	10	<b>DLS9448</b>	10



style DLS

Clamps

WaveSeal Clamps

Application:

- provides optimal retention in applications involving thermal cycling and / or high vibration

Features:

- produces a sealing O-ring effect that prevents leakage
- 5/16" head screw
- suggested installation torque 50-70 inch pounds
- **all clamps sold 10 per box**
- construction:
  - band: 300 stainless steel
  - liner and housing: 300 stainless steel
  - screw: 410 stainless steel
- Torque ratings correspond to the torque rating of the screw of the clamp and are not an indication of the working pressure of any hose assembly installed with this clamp. 

Band Width	Hose OD		Part #	Pkg Qty
	from	to		
9/16"	1-3/32"	1-5/16"	<b>WSS16</b>	10
	1-1/8"	1-1/2"	<b>WSS19</b>	10
	1-1/8"	1-9/16"	<b>WSS20</b>	10
	1-7/16"	1-11/16"	<b>WSS22</b>	10
	1-1/2"	1-13/16"	<b>WSS24</b>	10
	1-3/4"	2-1/16"	<b>WSS28</b>	10
	1-15/16"	2-5/16"	<b>WSS32</b>	10
	2"	2-7/16"	<b>WSS34</b>	10
	2-1/8"	2-9/16"	<b>WSS36</b>	10
	2-5/16"	2-13/16"	<b>WSS40</b>	10
	2-1/2"	3-1/16"	<b>WSS44</b>	10
	2-11/16"	3-5/16"	<b>WSS48</b>	10
	2-7/8"	3-9/16"	<b>WSS52</b>	10
	3-1/16"	3-13/16"	<b>WSS56</b>	10
	3-1/4"	4-1/16"	<b>WSS60</b>	10
	3-7/16"	4-5/16"	<b>WSS64</b>	10
	3-3/4"	4-13/16"	<b>WSS72</b>	10
	4-3/16"	5-5/16"	<b>WSS80</b>	10
	4-1/2"	5-13/16"	<b>WSS88</b>	10



## Constant Torque Worm Gear Clamps

## Features:

- A patented Belleville spring mechanism permits the clamp to automatically increase or decrease its own diameter due to changes in operational or environmental temperatures.
- 3/8" hex, carbon steel screw
- 5/8" wide 300 stainless steel band

Clamps



Band Width	Hose OD		Part #
	from	to	
5/8"	1"	1 3/4"	<b>CT175L</b>
	1 1/4"	2 1/8"	<b>CT200L</b>
	1 3/4"	2 5/8"	<b>CT250L</b>
	2 1/4"	3 1/8"	<b>CT300L</b>
	2 3/4"	3 5/8"	<b>CT350L</b>
	3 1/4"	4 1/8"	<b>CT400L</b>
	3 3/4"	4 5/8"	<b>CT450L</b>
	4 1/4"	5 1/8"	<b>CT500L</b>
	4 3/4"	5 5/8"	<b>CT550L</b>
	5 1/4"	6 1/8"	<b>CT600L</b>
	5 3/4"	6 5/8"	<b>CT650L</b>
	6 1/4"	7 1/8"	<b>CT700L</b>
	6 3/4"	7 5/8"	<b>CT750L</b>
	7 1/4"	8 1/8"	<b>CT800L</b>
	7 3/4"	8 5/8"	<b>CT850L</b>
	8 1/4"	9 1/8"	<b>CT900L</b>
8 3/4"	9 5/8"	<b>CT950L</b>	

## HTM Hi Torque Worm Gear Clamps

## Features:

- withstands more than three times the SAE torque requirements for worm-driven clamps
- eight screw threads are engaged in the band simultaneously for incredible torquing drive (over 90 in. lbs.), sealing pressure and vibration resistance
- slotted hex head screw design
- Torque ratings correspond to the torque rating of the screw of the clamp and *are not an indication of the working pressure of any hose assembly installed with this clamp.* 

## Materials:

- band and housing: 300 series half hard stainless <sup>1</sup>
- screw: 410 stainless steel screw



style HTM



style HP

Band Width	Hose OD		Stainless Steel Part #
	from	to	
5/8"	1 1/4"	2 1/8"	<b>HTM200</b>
	1 1/4"	2 5/8"	<b>HP2</b> <sup>1</sup>
	1 3/4"	2 5/8"	<b>HTM250</b>
	2 1/8"	4 1/8"	<b>HP3</b> <sup>1</sup>
	2 1/4"	3 1/8"	<b>HTM300</b>
	2 3/4"	3 5/8"	<b>HTM350</b>
	3 1/2"	4 1/8"	<b>HTM400</b>
	3 3/4"	4 5/8"	<b>HTM450</b>
	4"	6 1/8"	<b>HP4</b> <sup>1</sup>
	4 1/4"	5 1/8"	<b>HTM500</b>
	4 3/4"	5 5/8"	<b>HTM550</b>
	5 1/4"	6 1/8"	<b>HTM600</b>
	5 3/4"	6 5/8"	<b>HTM650</b>
	6 1/8"	9 1/8"	<b>HP5</b> <sup>1</sup>
	6 1/4"	7 1/8"	<b>HTM700</b>
	6 3/4"	7 5/8"	<b>HTM750</b>
7 1/4"	8 1/8"	<b>HTM800</b>	
7 3/4"	8 5/8"	<b>HTM850</b>	
8 1/4"	9 1/8"	<b>HTM900</b>	

<sup>1</sup> extended hose OD range

Center Punch Band Clamps

Features:

- install with center punch tools F1, F38, F40 and F100 located on page 271 other manufacturer's punch style tools may also be used
- on stainless clamps, bands are 300 series stainless steel, buckles are 302 series stainless steel
- sold in package quantities only

Pre-formed F Series

Band Width	Clamp ID	Band THK	Stainless Steel Part #	Pkg Qty	Band THK	Galvanized Steel Part #	Pkg Qty
3/8"	13/16"	.020"	<b>FS3</b>	100	.025"	<b>F3</b>	100
	1-3/8"	.020"	<b>FS311</b>	100	.025"	<b>F311</b>	100
5/8"	1"	.022"	<b>FS4</b>	100	.025"	<b>F4</b>	100
	1-1/4"	.022"	<b>FS5</b>	100	.025"	<b>F5</b>	100
	1-1/2"	.022"	<b>FS6</b>	100	.031"	<b>F6</b>	100
	1-3/4"	.022"	<b>FS7</b>	100	.031"	<b>F7</b>	100
	2"	.022"	<b>FS8</b>	100	.031"	<b>F8</b>	100
	2-1/4"	.022"	<b>FS9</b>	100	.031"	<b>F9</b>	100
	2-1/2"	.022"	<b>FS10</b>	50	.031"	<b>F10</b>	50
	2-3/4"	.022"	<b>FS11</b>	50	.031"	<b>F11</b>	50
	3"	.022"	<b>FS12</b>	50	.031"	<b>F12</b>	50
	3-1/2"	.022"	<b>FS14</b>	50	.031"	<b>F14</b>	50
	4"	.022"	<b>FS16</b>	25	.031"	<b>F16</b>	25
	4-1/2"	.022"	<b>FS18</b>	25	.031"	<b>F18</b>	25
	5"	.022"	<b>FS20</b>	25	.031"	<b>F20</b>	25
	6"	.022"	<b>FS24</b>	25	.031"	<b>F24</b>	25
	7"	.022"	<b>FS28</b>	25	.031"	<b>F28</b>	25
	8"	.022"	<b>FS32</b>	25	.031"	<b>F32</b>	25



Clamps



Open End FO Series

Band Width	Clamp ID	Band THK	Stainless Steel Part #	Pkg Qty	Band THK	Galvanized Steel Part #	Pkg Qty
3/8"	13/16"	.020"	<b>FOS3</b>	100	.025"	<b>FO3</b>	100
	1-3/8"	.020"	<b>FOS311</b>	100	.025"	<b>FO311</b>	100
	2"	.020"	<b>FOS316</b>	100	.025"	<b>FO316</b>	100
	3-1/8"	.020"	<b>FOS325</b>	100	.025"	<b>FO325</b>	100
5/8"	2"	.022"	<b>FOS8</b>	100	.025"	<b>FO8</b>	100
	2-1/2"	.022"	<b>FOS10</b>	50	.025"	<b>FO10</b>	50
	3"	.022"	<b>FOS12</b>	50	.031"	<b>FO12</b>	50
	3-1/2"	.022"	<b>FOS14</b>	50	.031"	<b>FO14</b>	50
	4"	.022"	<b>FOS16</b>	50	.031"	<b>FO16</b>	50
	4-1/2"	.022"	<b>FOS18</b>	50	.031"	<b>FO18</b>	50
	5"	.022"	<b>FOS20</b>	25	.031"	<b>FO20</b>	25
	6"	.022"	<b>FOS24</b>	25	.031"	<b>FO24</b>	25
	7"	.022"	<b>FOS28</b>	25	.031"	<b>FO28</b>	25
	8"	.022"	<b>FOS32</b>	25	.031"	<b>FO32</b>	25
	9"	.022"	---	---	.031"	<b>FO36</b>	25
	10"	.022"	---	---	.031"	<b>FO40</b>	25
	12"	.022"	---	---	.031"	<b>FO48</b>	25
	14"	.022"	---	---	.031"	<b>FO56</b>	10



## Universal Pre-formed K series

**Features:**

- on stainless clamps, bands are 300 series stainless steel, buckles are 302 series stainless steel
- can be center punched or rolled over, install with the center punch or roll over tools located on page 271
- Fast-Lok™ tools: F1, F40, F100 page 271
- Super Strap Tools: 51960 screw action with 51970 adapter page 272
- Bandit®: S100 air tool with S180 Jr. head, C-001 hand tool with J001 Jr. adapter, S350 air tool with S260 Jr. head, T-240 for 3/8" only or T-250 for 3/8" and 5/8", S-38 for 3/8" and 5/8", J-102 Pok-It™ for 3/8" only.
- Punch-Lok® tools: P-1000 for 3/8" and 5/8", P-3000 for 3/8" only, P-38 for 3/8" and 5/8"
- **sold in package quantities only**

Band Width	Clamp ID	Band THK	Stainless Steel Part #	Pkg Qty	Band THK	Galvanized Steel Part #	Pkg Qty
3/8"	13/16"	.025"	<b>KS3</b>	100	.025"	<b>K3</b>	100
	1-3/8"	.025"	<b>KS311</b>	100	.025"	<b>K311</b>	100
5/8"	1"	.030"	<b>KS4</b>	100	.031"	<b>K4</b>	100
	1-1/4"	.030"	<b>KS5</b>	100	.031"	<b>K5</b>	100
	1-1/2"	.030"	<b>KS6</b>	100	.031"	<b>K6</b>	100
	1-3/4"	.030"	<b>KS7</b>	100	.031"	<b>K7</b>	100
	2"	.030"	<b>KS8</b>	100	.031"	<b>K8</b>	100
	2-1/4"	.030"	<b>KS9</b>	100	.031"	<b>K9</b>	100
	2-1/2"	.030"	<b>KS10</b>	50	.031"	<b>K10</b>	50
	2-3/4"	.030"	<b>KS11</b>	50	.031"	<b>K11</b>	50
	3"	.030"	<b>KS12</b>	50	.031"	<b>K12</b>	50
	3-1/2"	.030"	<b>KS14</b>	50	.031"	<b>K14</b>	50
	4"	.030"	<b>KS16</b>	25	.031"	<b>K16</b>	25
	4-1/2"	.030"	<b>KS18</b>	25	.031"	<b>K18</b>	25
	5"	.030"	<b>KS20</b>	25	.031"	<b>K20</b>	25
	6"	.030"	<b>KS24</b>	25	.031"	<b>K24</b>	25
	7"	.030"	<b>KS28</b>	25	.031"	<b>K28</b>	25
	8"	.030"	<b>KS32</b>	25	.031"	<b>K32</b>	25

Dixon® Smooth ID - Roll Over Type Clamps

**Application:**

- for use with industrial hose made of stiffer, thinner thermoplastics

**Features:**

- provide a uniform, gap-free inside diameter, and strong holding power
- Install with roll over type clamp tools and most common band clamp tools such as the 51960 and 51970 band tools on page 272.
- **sold in package quantities only**

Band Width	Clamp ID	Band THK	201 Stainless Steel Part #	Pkg Qty	Galvanized Steel Part #	Pkg Qty
3/8"	13/16"	.025"	<b>JS201</b>	100	<b>JS301</b>	100
	1"	.025"	<b>JS243</b>	100	<b>JS343</b>	100
	1-3/8"	.025"	<b>JS202</b>	100	<b>JS302</b>	100
	2"	.025"	<b>JS245</b>	100	---	---
1/2"	1"	.030"	<b>JS203</b>	100	<b>JS303</b>	100
	1-1/4"	.030"	<b>JS204</b>	100	<b>JS304</b>	100
	2-3/4"	.030"	<b>JS230</b>	100	<b>JS330</b> <sup>1</sup>	100
5/8"	1-1/2"	.030"	<b>JS205</b>	100	<b>JS305</b>	100
	1-3/4"	.030"	<b>JS206</b>	100	<b>JS306</b>	100
	2"	.030"	<b>JS207</b>	100	<b>JS307</b>	100
	2-1/4"	.030"	<b>JS208</b>	100	<b>JS308</b>	100
	2-1/2"	.030"	<b>JS209</b>	100	<b>JS309</b>	100
3/4"	2-3/4"	.030"	<b>JS210</b>	50	---	---
	3"	.030"	<b>JS211</b>	50	<b>JS311</b>	50
	3-1/2"	.030"	<b>JS212</b>	50	<b>JS312</b>	50
	4"	.030"	<b>JS213</b>	25	<b>JS313</b>	25
	4-1/2"	.030"	<b>JS214</b>	25	<b>JS314</b>	25
	5"	.030"	<b>JS215</b>	25	<b>JS315</b>	25
	6"	.030"	<b>JS216</b>	25	---	---
	7"	.030"	<b>JS218</b>	25	---	---

<sup>1</sup> stock quantities only



Clamps

Dixon® Smooth ID Center Punch Clamps

**Application:**

- for use in applications where conditions are highly corrosive

**Features:**

- double wrapped and locked with the conical punch of the F100 tool page 271
- unique dimple design offers excellent sealing strength while maintaining radial compression
- heavy buckle provides optimal holding power
- ideal for thin wall hose
- low profile
- **sold in package quantities only**

Band Width	Clamp ID	Band THK	201 Stainless Steel Part #	Pkg Qty
5/8"	1"	.025"	<b>HBC4S</b>	100
	1 1/4"	.025"	<b>HBC5S</b>	100
	1 1/2"	.025"	<b>HBC6S</b>	100
	1 3/4"	.025"	<b>HBC7S</b>	100
	2"	.025"	<b>HBC8S</b>	100
	2 1/4"	.025"	<b>HBC9S</b>	100
	2 1/2"	.025"	<b>HBC10S</b>	50
	2 3/4"	.025"	<b>HBC11S</b>	50
	3"	.025"	<b>HBC12S</b>	50
	3 1/2"	.025"	<b>HBC14S</b>	50
	4"	.025"	<b>HBC16S</b>	25
	4 1/2"	.025"	<b>HBC18S</b>	25
	5"	.025"	<b>HBC20S</b>	25
	6"	.025"	<b>HBC24S</b>	25
	7"	.025"	<b>HBC28S</b>	25
	8"	.025"	<b>HBC32S</b>	25



## Band &amp; Buckles System

Clamps

**Features:**

- install with C2 or 51960 band clamp tools
- **sold in box quantities only**

Band Width	201 Stainless Steel Part #	Pkg Qty	Galvanized Steel Part #	Pkg Qty
3/8"	<b>CS375</b>	100	<b>CG375</b>	100
1/2"	<b>CS500</b>	100	<b>CG500</b>	100
5/8"	<b>CS625</b>	100	<b>CG625</b>	100
3/4"	<b>CS750</b>	100	<b>CG750</b>	50

## Strapping

**Feature:**

- install with C2 or 51960 band clamp tools



Band Width	Band Thickness	Length	201 Stainless Steel Part #	Galvanized Steel Part #
3/8"	.025"	100'	<b>SS375</b>	<b>SG375</b>
1/2"	.031"	100'	<b>SS500</b>	<b>SG500</b>
5/8"	.031"	100'	<b>SS625</b>	<b>SG625</b>
3/4"	.031"	100'	<b>SS750</b>	<b>SG750</b>

## Set Screw Buckles

**Application:**

- Used in applications when a temporary clamp is desired or space limitations do not allow for tool roll-over

**Features:**

- set screw locks band after tensioning
- **sold in box quantities only**



Band Width	201 Stainless Steel Part #	Pkg Qty
1/2"	<b>SSB500</b>	25
3/4"	<b>SSB750</b> <sup>1</sup>	25

<sup>1</sup> 3/4" buckle may be used with 5/8" band

## Stainless Steel Banding with Tote

**Features:**

- resistant to moisture
- built-in handle
- full view of available band
- easy to dispense and recoil



Band Width	Band Thickness	Length	Package Description	201 Stainless Steel Part #
1/2"	.030"	100'	plastic blue tote	<b>ST204B</b>
5/8"	.030"	100'	plastic green tote	<b>ST205G</b>
3/4"	.030"	100'	plastic red tote	<b>ST206R</b>



Band Clamp Hand Tools

Locking Hand Tool

Features:

- for application of punch type  $\frac{3}{8}$ " and  $\frac{5}{8}$ " band clamps
- for use with F series only

Part #

**F38**



Clamps

Intermediate Hand Tool

Feature:

- for application of  $\frac{3}{8}$ " and  $\frac{5}{8}$ " band clamps

Part #

**F40**



Hand Tool for  $\frac{5}{8}$ " Clamps

Features:

- for application of  $\frac{5}{8}$ " band clamps
- imported

Part #

**F1**



Hand Tool for  $\frac{3}{8}$ " &  $\frac{5}{8}$ " Clamps

Features:

- for application of  $\frac{3}{8}$ " and  $\frac{5}{8}$ " band clamps
- Made in the USA

Part #

**F100**



Adapter for F100 Tool

Feature:

- $\frac{3}{8}$ " clamp adapter for F100 tool only

Part #

**F229**

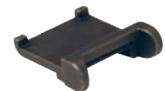

## Band &amp; Worm Gear Clamps: Clamp Tools

## Band Clamp Punching Mallet



Part #

**F225**

## Clamp Cutter



Part #

**F550**

## Band &amp; Buckle Clamping Tools



Description	Part #
Clamping tool for band and buckles	<b>C2</b>

Note: once stock is depleted product will be obsolete



Description	Part #
Clamping tool for band and buckles	<b>51960</b>

**Feature:**

- for 51960 tool above



Description	Part #
adapter for 51960 tool to install preformed clamps	<b>51970</b>

Pinch-On Clamps

Single Ear

Features:

- band width: .275"
- band thickness: .030"
- sold in package quantities only

Nominal Size	Range		Zinc Plated Steel	304 Stainless Steel	Pkg Qty
	closed	open	Part #	Part #	
3/8"	.350"	.413"	105	105R	100
7/16"	.382"	.445"	113	113R	100
15/32"	.409"	.484"	123	123R	100
1/2"	.449"	.524"	133	133R	100
35/64"	.469"	.551"	140	140R	100
9/16"	.496"	.571"	145	145R	100
5/8"	.543"	.618"	157	157R	100
11/16"	.595"	.669"	170	170R	100
23/32"	.618"	.728"	185	185R	100
3/4"	.669"	.780"	198	198R	100
13/16"	.717"	.827"	210	210R	100
7/8"	.780"	.890"	226	226R	100
15/16"	.839"	.949"	241	241R	100
1"	.898"	1.008"	256	256R	100
1-1/16"	.945"	1.067"	271	271R	100
1-1/8"	1.004"	1.126"	286	286R	100
1-3/16"	1.063"	1.185"	301	301R	100
1-5/16"	1.181"	1.303"	331	331R	100
1-3/8"	1.240"	1.362"	346	346R	100
1-15/32"	1.358"	1.480"	376	376R	100
1-9/16"	1.437"	1.559"	396	396R	100
1-5/8"	1.492"	1.614"	410	410R	100
1-11/16"	1.551"	1.673"	425	425R	100
1-23/32"	1.610"	1.732"	440	440R	100
1-3/4"	1.669"	1.791"	455	455R	100
1-13/16"	1.728"	1.850"	470	470R	100
1-7/8"	1.787"	1.909"	485	485R	100
1-15/16"	1.847"	1.969"	500	500R	100
2"	1.906"	2.028"	515	515R	100



Clamps



Double Ear

Features:

- When ordering double ear clamps, select nominal clamp size nearest to, but always larger than, the OD of material to be clamped after insert has been fitted.
- sold in package quantities only

Nominal Size	Range		Band Width	Zinc Plated Steel	304 Stainless Steel	Pkg Qty
	closed	open		Part #	Part #	
3/16"	.134"	.197"	.197"	0305	0305R	100
1/4"	.197"	.276"	.236"	0507	0507R	100
5/16"	.276"	.354"	.275"	0709	0709R	100
3/8"	.319"	.433"	.275"	0811	0811R	100
1/2"	.425"	.512"	.275"	1113	1113R	100
9/16"	.492"	.591"	.295"	1315	1315R	100
19/32"	.551"	.669"	.315"	1517	1517R	100
5/8"	.591"	.709"	.315"	1518	1518R	100
3/4"	.638"	.787"	.335"	1720	1720R	100
13/16"	.709"	.866"	.354"	1922	1922R	100
7/8"	.748"	.906"	.354"	2023	2023R	100
15/16"	.827"	.984"	.394"	2225	2225R	100
1"	.886"	1.063"	.394"	2327	2327R	100
1-1/8"	1.035"	1.221"	.394"	2731	2731R	100
1-7/16"	1.260"	1.457"	.394"	3437	3437R	100
1-1/2"	1.378"	1.575"	.394"	3740	3740R	100



## Pinch-On Stepless® Ear Clamps

Clamps

**Features:**

- once installed and clamped tampering is easily visible
- *Clamps are not reusable*; they should not be pried open, doing so renders the clamp nonfunctional. 
- ensured clamping seal
- for low durometer or thin-walled hose/tubing
- for silicon, vinyl, polyurethane or other high-tech materials
- smooth inner band prevents damage to the hose while the tongue-in-groove design provides a 360° seal
- no steps or gaps inside the clamp
- install clamps using 1098 or 1099 clamp tools below
- clamps hold against pressure, vibration and material shrinkage due to temperature changes or aging
- built-in spring action permits the clamp to breathe without loosening
- When ordering, select the nominal size nearest to, but always larger than, the outside diameter of the material to be clamped. The outside diameter should be determined with connection fully assembled.
- **sold in package quantities only**

Nominal Size	Range (inches)		304 Stainless Steel Part #	Pky Qty
	closed	open		
9/32"	.228"	.275"	<b>0983</b>	100
3/8"	.307"	.374"	<b>0986</b>	100
7/16"	.378"	.445"	<b>0989</b>	100
1/2"	.425"	.524"	<b>0993</b>	100
35/64"	.453"	.551"	<b>0997</b>	100
9/16"	.472"	.571"	<b>0999</b>	100
5/8"	.520"	.618"	<b>1005</b>	100
11/16"	.571"	.669"	<b>1009</b>	100
3/4"	.654"	.779"	<b>1021</b>	100
13/16"	.701"	.827"	<b>1029</b>	100

**Clamp Service Kit****Includes:**

- 15 of part #0709
- 15 of part #0811
- 15 of part #1113
- 15 of part #1315
- 15 of part #1518
- 12 of part #1720
- 12 of part #2023
- 12 of part #2225
- 12 of part #2327
- 1 pair of standard jaw pincers, part # 1098



Part #

**SK1098****Standard Jaw Clamp Tool**

Part #

**1098****Side Jaw Clamp Tool**

Part #

**1099**

### Dixon® Worm Gear Clamp Racks

**Features:**

- top load metal rack made of nickel plated steel rods with enameled steel sign
- sign identifies each clamp size and diameter range
- rack with clamps contains 9 clamp sizes with diameter ranges from 7/32" - 2-3/4"
- **CRWC**, Clamps included are:
  - 30 of part# MH4
  - 30 of part# MH6
  - 20 of part# HS10
  - 20 of part# HS12
  - 20 of part# HS20
  - 20 of part# HS24
  - 20 of part# HS28
  - 20 of part# HS32
  - 20 of part# HS36

Description	Part #
with 200 clamps	<b>CRWC</b>
without clamps	<b>CR</b>

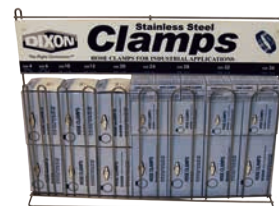

CRWC



CR

Clamps

### Quick Release Worm Gear Clamps

**Features:**

- suggested installation torque 25-35 inch pounds, maximum recommended torque 50 in. lbs.
- band and housing: 201 series stainless
- screw design: 5/16" slotted hex head
- **Parts showing package quantities are sold in package quantities only.**
- Torque ratings correspond to the torque rating of the screw of the clamp and *are not an indication of the working pressure of any hose assembly installed with this clamp.*



Style LS:

- screw: plated hardened carbon steel

Style LSS:

- screw: SAE 410 series stainless

Band Width	Hose OD		style LS Part #	Pkg Qty	style LSS Part #	Pkg Qty
	from	to				
1/2"	1-1/2"	3-1/2"	<b>LS48</b>	10	<b>LSS48</b>	10
	1"	4"	<b>LS56</b>	10	---	---
	2"	5"	<b>LS72</b>	10	<b>LSS72</b>	10
	2-1/16"	6"	<b>LS88</b>	10	<b>LSS88</b>	10
	3-1/2"	6-9/16"	<b>LS96</b>	---	---	---
	2-7/8"	7"	<b>LS104</b>	10	<b>LSS104</b>	10
	1-3/4"	8-9/16"	<b>LS128</b>	---	<b>LSS128</b>	---
	2"	10"	<b>LS152</b>	---	---	---
	2-1/16"	12-5/16"	<b>LS188</b>	---	<b>LSS188</b>	---
	10-3/16"	14"	---	---	<b>LSS216</b>	---
	1-3/4"	16"	---	---	<b>LSS248</b>	---
	1-7/8"	20"	---	---	<b>LSS312</b>	---



style LS



style LSS

E

### Worm Gear Make-A-Clamp Kits

**Features:**

- A maintenance clamp system in a box; by simply cutting off a piece of banding from a continuous roll, you can make any size stainless steel worm-driven clamp from 2" diameter and up. Perfect applications requiring for varying sized large clamps.
- reusable
- band width: 1/2"
- band thickness: .023"
- screw design: 5/16" slotted hex head
- band and housing material: 300 stainless
- screw material: 410 stainless

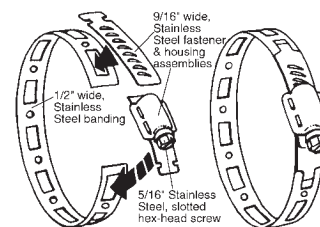

Contents	Stainless Steel Part #
mini kit: 8 1/2' band, 3 adjustable fasteners, 1 band splice	<b>4000</b>
kit with 100' band, 25 adjustable fasteners, 10 band splices	<b>4001</b>
kit with 50' band, 10 adjustable fasteners, 5 band splices	<b>4002</b>
box with 10 adjustable fasteners: priced per box	<b>4004</b>
box with 100' band, 10 band splices	<b>4005</b>
box with 50' band, 5 band splices	<b>4006</b>
6" demonstrator kit with clamps	<b>4007</b>
box with 10 band splices: priced per box	<b>4008</b>



## T-Bolt Clamps

## Features:

## Style TBC

- can be applied with a standard 7/16" socket wrench
- 3/4" wide, .025" thick, 300 series stainless steel band
- alloy steel bolt, torque rating: 70 in/lbs
- not for use with pneumatic tools 

## Style STBC

- can be applied with a standard 7/16" socket wrench
- 3/4" wide, .025" thick, 300 series stainless steel band
- 300 series stainless steel bolt, torque rating: 50 in/lbs
- not for use with pneumatic tools 

Clamps



style TBC



style STBC

Hose OD		style TBC Part #	Hose OD		style STBC Part #	Optional Qty
from	to		from	to		
1.25"	1.406"	<b>TBC131</b>	1.25"	1.4063"	<b>STBC131</b>	25
1.34"	1.56"	<b>TBC150</b>	1.31"	1.56"	<b>STBC150</b>	25
1.56"	1.81"	<b>TBC175</b>	1.44"	1.69"	<b>STBC163</b>	25
1.69"	1.94"	<b>TBC188</b>	1.56"	1.81"	<b>STBC175</b>	25
1.81"	2.06"	<b>TBC200</b>	1.69"	1.94"	<b>STBC188</b>	25
2.06"	2.31"	<b>TBC225</b>	1.81"	2.06"	<b>STBC200</b>	25
2.19"	2.5"	<b>TBC238</b>	1.93"	2.18"	<b>STBC212</b>	25
2.31"	2.62"	<b>TBC250</b>	2.06"	2.31"	<b>STBC225</b>	25
2.31"	2.62"	<b>TBC256</b>	2.19"	2.5"	<b>STBC238</b>	25
2.37"	2.68"	<b>TBC263</b>	2.31"	2.62"	<b>STBC250</b>	25
2.50"	2.81"	<b>TBC275</b>	2.31"	2.62"	<b>STBC256</b>	25
2.63"	2.94"	<b>TBC288</b>	2.37"	2.68"	<b>STBC263</b>	25
2.75"	3.06"	<b>TBC300</b>	2.50"	2.81"	<b>STBC275</b>	25
2.88"	3.19"	<b>TBC312</b>	2.63"	2.94"	<b>STBC288</b>	25
3.00"	3.31"	<b>TBC325</b>	2.75"	3.06"	<b>STBC300</b>	25
3.25"	3.56"	<b>TBC350</b>	2.88"	3.19"	<b>STBC312</b>	25
3.50"	3.81"	<b>TBC375</b>	3.00"	3.31"	<b>STBC325</b>	25
3.56"	3.87"	<b>TBC382</b>	3.25"	3.56"	<b>STBC350</b>	25
3.75"	4.06"	<b>TBC400</b>	3.38"	3.69"	<b>STBC362</b>	25
4.00"	4.30"	<b>TBC425</b>	3.50"	3.81"	<b>STBC375</b>	25
4.25"	4.56"	<b>TBC450</b>	3.56"	3.87"	<b>STBC382</b>	25
4.50"	4.81"	<b>TBC475</b>	3.75"	4.06"	<b>STBC400</b>	25
4.75"	5.06"	<b>TBC500</b>	4.00"	4.30"	<b>STBC425</b>	25
5.00"	5.31"	<b>TBC525</b>	4.25"	4.56"	<b>STBC450</b>	25
5.25"	5.56"	<b>TBC550</b>	4.50"	4.81"	<b>STBC475</b>	25
5.50"	5.81"	<b>TBC575</b>	4.75"	5.06"	<b>STBC500</b>	25
5.75"	6.06"	<b>TBC600</b>	5.00"	5.31"	<b>STBC525</b>	25
6.00"	6.31"	<b>TBC625</b>	5.25"	5.56"	<b>STBC550</b>	25
6.25"	6.56"	<b>TBC650</b>	5.50"	5.81"	<b>STBC575</b>	25
6.50"	6.81"	<b>TBC675</b>	5.75"	6.06"	<b>STBC600</b>	25
6.75"	7.06"	<b>TBC700</b>	6.00"	6.31"	<b>STBC625</b>	25
7.25"	7.56"	<b>TBC750</b>	6.25"	6.56"	<b>STBC650</b>	25
			6.50"	6.81"	<b>STBC675</b>	25
			6.75"	7.06"	<b>STBC700</b>	25
			7.00"	7.31"	<b>STBC725</b>	25
			7.25"	7.56"	<b>STBC750</b>	25
			7.75"	8.06"	<b>STBC800</b>	25
			8.00"	8.31"	<b>STBC825</b>	25
			8.25"	8.56"	<b>STBC850</b>	25
			8.63"	8.94"	<b>STBC888</b>	25
			8.75"	9.06"	<b>STBC900</b>	25
			9.25"	9.56"	<b>STBC950</b>	25
			9.75"	10.06"	<b>STBC1000</b>	10
			10.63"	10.94"	<b>STBC1088</b>	10
			11.75"	12.06"	<b>STBC1200</b>	10
			12.63"	12.94"	<b>STBC1288</b>	10

Heavy Duty T-Bolt Clamps

Features:

- can be applied with a standard 1/2" socket wrench.
- 7/8" wide, .040" thick, 300 series stainless steel band
- style HTBC carbon steel bolt, torque rating: 150 in/lbs
- style HSTBC 300 series stainless steel bolt, torque rating: 150 in/lbs
- not for use with pneumatic tools 

Hose OD		style HTBC	style HSTBC
from	to	Part #	Part #
2.125"	2.4375"	<b>HTBC238</b>	<b>HSTBC238</b>
2.250"	2.5625"	<b>HTBC250</b>	<b>HSTBC250</b>
2.750"	3.0625"	<b>HTBC300</b>	<b>HSTBC300</b>
3.250"	3.5625"	<b>HTBC350</b>	<b>HSTBC350</b>
3.750"	4.0625"	<b>HTBC400</b>	<b>HSTBC400</b>
4.250"	4.5625"	<b>HTBC450</b>	<b>HSTBC450</b>
4.750"	5.0625"	<b>HTBC500</b>	<b>HSTBC500</b>
5.250"	5.5625"	<b>HTBC550</b>	<b>HSTBC550</b>
5.750"	6.0625"	<b>HTBC600</b>	<b>HSTBC600</b>
6.250"	6.5625"	<b>HTBC650</b>	<b>HSTBC650</b>
6.750"	7.0625"	<b>HTBC700</b>	<b>HSTBC700</b>
7.250"	7.5625"	<b>HTBC750</b>	<b>HSTBC750</b>
7.750"	8.0625"	<b>HTBC800</b>	<b>HSTBC800</b>
8.266"	8.562"	---	<b>HSTBC850</b>
8.646"	8.942"	---	<b>HSTBC888</b>
8.766"	9.062"	---	<b>HSTBC900</b>
9.266"	9.562"	---	<b>HSTBC950</b>
9.766"	10.062"	---	<b>HSTBC1000</b>
10.646"	10.942"	---	<b>HSTBC1088</b>
12.646"	12.942"	---	<b>HSTBC1288</b>



style HTBC



style HSTBC

Clamps



Long Bolt T-Bolt Clamps

Features:

- can be applied with a standard 7/16" socket wrench.
- ¾" wide, .025" thick, 300 series stainless steel band
- 300 series stainless steel bolt, torque rating: 50 in/lbs
- not for use with pneumatic tools 

Clamps



Hose OD		300 series Stainless Steel	Optional
from	to	Part #	Qty
2.80"	3.37"	<b>STBC325L</b>	25
3.05"	3.62"	<b>STBC350L</b>	25
3.37"	3.94"	<b>STBC382L</b>	25
3.55"	4.12"	<b>STBC400L</b>	25
3.75"	4.32"	<b>STBC420L</b> <sup>1</sup>	25
3.87"	4.44"	<b>STBC432L</b>	25
4.05"	4.62"	<b>STBC450L</b>	25
4.37"	4.94"	<b>STBC482L</b>	25
4.55"	5.12"	<b>STBC500L</b>	25
4.87"	5.44"	<b>STBC532L</b>	25
5.05"	5.62"	<b>STBC550L</b>	25
5.37"	5.94"	<b>STBC582L</b>	25
5.55"	6.12"	<b>STBC600L</b> <sup>1</sup>	25
5.87"	6.44"	<b>STBC632L</b>	25
6.05"	6.62"	<b>STBC650L</b>	25
6.30"	6.87"	<b>STBC675L</b>	25
6.53"	7.10"	<b>STBC698L</b>	25
6.55"	7.12"	<b>STBC700L</b> <sup>1</sup>	25
6.62"	7.19"	<b>STBC707L</b>	25
8.05"	8.62"	<b>STBC850L</b>	25
8.30"	8.87"	<b>STBC875L</b>	25
8.43"	9.00"	<b>STBC888L</b>	25
8.62"	9.19"	<b>STBC907L</b>	25
10.25"	10.82"	<b>STBC1070L</b>	25
10.43"	11.00"	<b>STBC1088L</b>	25
10.62"	11.19"	<b>STBC1107L</b> <sup>1</sup>	25
10.72"	11.29"	<b>STBC1117L</b>	25
12.20"	12.77"	<b>STBC1265L</b>	25
12.43"	13.00"	<b>STBC1288L</b>	25
12.75"	13.32"	<b>STBC1320L</b>	25
14.20"	14.77"	<b>STBC1465L</b>	25
14.43"	15.00"	<b>STBC1488L</b>	25
14.75"	15.32"	<b>STBC1520L</b>	25
16.20"	16.77"	<b>STBC1665L</b>	25
16.43"	17.00"	<b>STBC1688L</b>	25

<sup>1</sup> stock quantities only



Double Bolt Clamps

Features:

- inner surface has dual gripping ridges
- bolt lugs are reinforced to prevent bending out of alignment
- Torque values for clamps are based on dry bolts.
- The use of lubricant on bolts will adversely effect clamp performance.
- measure hose OD accurately before ordering clamps
- Consult Dixon® when using double bolt clamps on helical wire hose.



Hose OD		Plated Iron Part #	Torque in ft. lbs.	Optional Qty
from	to			
1-8/64"	1-12/64"	<b>J48</b>	15	100
1-12/64"	1-24/64"	<b>J49</b>	21	50
1-28/64"	1-34/64"	<b>JX49</b>	21	25
1-40/64"	1-52/64"	<b>DL14</b>	40	25
1-48/64"	2-3/64"	<b>DL20</b>	27	25
2-7/64"	2-19/64"	<b>DL24</b> <sup>1</sup>	27	25
2-20/64"	2-40/64"	<b>DL32</b> <sup>1</sup>	40	25
2-32/64"	2-48/64"	<b>DL275</b>	40	25
2-48/64"	3-4/64"	<b>DL306</b>	60	20
3-4/64"	3-24/64"	<b>DL328</b>	60	20
3-16/64"	3-32/64"	<b>DL350</b>	60	20



Clamps

<sup>1</sup> investment cast carbon steel

Double Bolt Clamps with Saddles

Hose OD		Plated Iron Part #	Torque in ft. lbs.	Optional Qty
from	to			
3-32/64"	3-52/64"	<b>400</b>	40	25
3-50/64"	4-4/64"	<b>431</b>	40	20
4-2/64"	4-18/64"	<b>463</b>	40	20
4-16/64"	4-60/64"	<b>525</b>	60	10
4-32/64"	5-16/64"	<b>550</b>	60	10
5-8/64"	5-44/64"	<b>600</b>	60	10
5-44/64"	5-60/64"	<b>639</b>	60	10
5-60/64"	6-32/64"	<b>675</b>	60	10
6-32/64"	7-36/64"	<b>769</b>	60	10
7-44/64"	8-12/64"	<b>818</b>	125	5
8-16/64"	8-56/64"	<b>875</b>	125	5
8-60/64"	9-56/64"	<b>988</b>	125	5
9-60/64"	11-24/64"	<b>1125</b>	125	5
11-12/64"	13"	<b>1275</b>	125	3
12-12/64"	14"	<b>1360</b>	200	2
13-12/64"	15"	<b>1450</b>	200	2
15-4/64"	17-32/64"	<b>1700</b>	260	2



## Single Bolt Clamps

## Features:

- measure hose OD accurately before ordering clamps
- Torque values for clamps are based on dry bolts.
- The use of lubricant on bolts will adversely effect clamp performance.



Clamps



Hose OD		Plated Iron Part #	Torque in ft. lbs.
from	to		
5/8"	1"	<b>2</b>	6
6/8"	1-8/64"	<b>3</b>	6
1-4/64"	1-12/64"	<b>4</b>	6
1-10/64"	1-16/64"	<b>5</b>	6
1-16/64"	1-24/64"	<b>6</b>	6
1-22/64"	1-28/64"	<b>7</b>	6
1-28/64"	1-36/64"	<b>8</b>	6
1-42/64"	1-48/64"	<b>10</b>	6
1-48/64"	1-56/64"	<b>11</b>	6
1-56/64"	2-2/64"	<b>12</b>	6
2"	2-8/64"	<b>13</b>	12
2-8/64"	2-18/64"	<b>14</b>	12
2-16/64"	2-26/64"	<b>15</b>	12
2-24/64"	2-32/64"	<b>16</b>	12
2-32/64"	2-40/64"	<b>17</b>	12
2-40/64"	2-56/64"	<b>18</b>	12
2-56/64"	3-4/64"	<b>19</b>	12
3-4/64"	3-16/64"	<b>20</b>	12
3-16/64"	3-28/64"	<b>21</b>	12
3-28/64"	3-40/64"	<b>22</b>	21
3-40/64"	3-52/64"	<b>23</b>	21
3-52/64"	4-8/64"	<b>24</b>	21
4-8/64"	4-20/64"	<b>25</b>	21
4-16/64"	4-32/64"	<b>26</b>	21
4-28/64"	4-40/64"	<b>27</b>	21
4-40/64"	4-56/64"	<b>X27</b>	21
4-56/64"	5-16/64"	<b>28</b>	21

## Spiral Clamps

**Features:**

- more than one clamp may be needed per size, contact the hose manufacturer for more information
- due to fluctuations in the OD of hose each individual installation should be checked 
- for use on convoluted cover hose
- To determine which style clamp is needed for your hose look at the end of the hose; if the helix spirals in a clockwise direction away from you (along the hose), a clockwise clamp is needed. If the helix spirals in a counterclockwise direction away from you, a counterclockwise clamp is needed. Examples include, but are not limited to: Kuriyama convoluted hose uses counter clockwise clamps; Pacific Echo and Kana Flex use clockwise clamps; Goodyear uses both counter clockwise and clockwise.

Clamps

### Clockwise

Size	Hose OD		Plated Steel, Right Hand Part #
	from	to	
1½"	1-34/64"	1-52/64"	<b>SC150</b>
2"	2-18/64"	2-32/64"	<b>SC200</b>
2½"	2-46/64"	3-8/64"	<b>SC250</b>
3"	3"	3-32/64"	<b>SC300</b>
4"	4"	4-32/64"	<b>SC400</b>
5"	5-6/64"	5-32/64"	<b>SC500</b>
6"	6-16/64"	7"	<b>SC600</b>
8"	8-32/64"	9-16/64"	<b>SC800</b>
10"	10-40/64"	11-16/64"	<b>SC1000</b>
12"	11-52/64"	12-61/64"	<b>SC1200</b>



E

### Counter Clockwise

Size	Hose OD		Plated Steel, Left Hand Part #
	from	to	
1½"	1-34/64"	1-52/64"	<b>SCCW150</b>
2"	2-18/64"	2-32/64"	<b>SCCW200</b>
2½"	2-46/64"	3-8/64"	<b>SCCW250</b>
3"	3"	3-32/64"	<b>SCCW300</b>
4"	4"	4-32/64"	<b>SCCW400</b>
5"	5-6/64"	5-32/64"	<b>SCCW500</b>
6"	6-16/64"	7"	<b>SCCW600</b>
8"	8-32/64"	9-16/64"	<b>SCCW800</b>
10"	10-40/64"	11-16/64"	<b>SCCW1000</b>
12"	11-52/64"	12-61/64"	<b>SCCW1200</b>



## Universal Couplings ..... 283 to 292

Air King™	283 to 284
Global Air King™	285 to 286
Air King™ with ferrule	287
Air King™ with gauge port	287
Air King™ universal swivels	287
Global Air King™ ferrules	288
Air King™ clamps	288
Air King™ accessories	289
Sand Blast	290
Surelock™	291 to 292

## Quick Disconnects ..... 293 to 327

Dix-Lock™ N-Series	293 to 296
Dual-Lock™ P-Series	297 to 299
Air Chief industrial	300 to 303
Dixon® key chain	301
Air Chief semi-auto	302
Air Chief automatic	303
Parker E-z-mate	304
Legris automatic safety couplers	305
Air Chief automotive	306 to 307
Air Chief ARO interchange	308 to 309
Air Chief Lincoln interchange	310
DF-series	311 to 315
J-series	316 to 317
M-series	318 to 319
CJ-series	320
SHD-series	321, 322
L-series	322
U-series	323
NK-series	324
BR-series	325
A-series	326 to 327

## Steel 3500 nipples ..... 328

## Bent Stem Swivels ..... 329

## D.O.T Air Brake ..... 330 to 341

D.O.T. push-in fittings	330 - 331
Connectors	330
Male elbows	330
Tees	331
Legris D.O.T. push-in fittings	332 to 335
Connectors	332
Unions	333
Elbows	333 to 334
Reducers	334
Tees	334 to 335
Air brake	336 to 341
Connectors	336
Unions	337
Elbows	337 to 338
Tees	339
Sleeves	339
Fittings for rubber hose	340 to 341

## Push-in ..... 342 to 360

Brass connectors	342
Unions	343
Elbows	343, 344
Tees	344, 345
Stainless steel Legris	346 to 347
Connectors	346
Unions & elbows	346, 347
Tees	347
Nickel-plated brass Legris	348 to 349
Connectors	348
Unions	348
Elbows	349
Tees	349
Nylon / Nickel-plated brass Legris	350 to 352, 354
Connectors	350
Elbows	351
Tees	352
Wyes	352
Nylon Legris	353
Unions	353
Plugs	353
Tees	353
Wyes	353
Manifold, Legris	354
Fittings kit	354
Fitting kit, Legris	354
Valves	355 to 357
Ball	355
Quick exhaust	355
Flow control	355, 356
Check	357
Metric	358 to 360
Connectors	358, 359, 360
Elbows	358, 360
Tees	359, 360
Unions	359, 360
Plugs	360

### **⚠ WARNING**

The constant vibration created by air tools, like air drills and pavement breakers, is destructive to air hose couplings, especially the quick-acting type. To provide protection against coupling breakage and related hazards, Dixon® recommends the use of a whip hose. To construct a whip hose, connect one end of a short (3' to 10') air hose to the air tool using a 3500 type steel nipple. Connect the other end of the hose to the air supply using the standard quick-acting coupling. The heat-treated 3500 nipple will withstand vibration far better than the standard coupling and provide a safer connection. The whip hose should remain permanently connected to the tool.

**⚠ WARNING**

- The use of an Air King™ safety clip or wire type retainer is necessary to ensure Air King™ universal couplings will not become accidentally disconnected. This guarantees the fittings are properly connected because the safety pin will not go through the holes in mating flanges until couplings are locked in place. Only one Air King™ safety clip or wire type retainer is required for each Air King™ universal coupling.

**Features:**

- can be used with Air King™ ferrules
- supplied with safety clip
- pressure rating: **150 PSI** at ambient temperature **70°F (21°C)**
- supplied with rubber washers, part # **AWR4**
- meets pressure requirements as specified in A-A-59553 commercial item description superseding Mil Spec.WWC-633D

**2-Lug Hose Ends**

Size	Iron Part #	Optional Qty	Brass Part #	Optional Qty	316 Stainless Steel Part #
3/8"	<b>AMH</b> <sup>1</sup>	25	<b>ABH</b>	25	<b>RAMH</b>
1/2"	<b>AM1</b>	50	<b>AB1</b> <sup>1</sup>	50	<b>RAM1</b>
5/8"	<b>AM5</b>	50	<b>AB5</b>	50	---
3/4"	<b>AM6</b>	50	<b>AB6</b> <sup>1</sup>	50	<b>RAM6</b>
1"	<b>AM11</b>	50	<b>AB11</b> <sup>1</sup>	50	<b>RAM11</b>

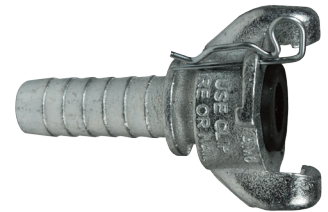

**2-Lug Male NPT Ends**

Size	Iron Part #	Optional Qty	Brass Part #	Optional Qty	316 Stainless Steel Part #
1/4"	<b>AMB1</b>	25	<b>ABB1</b>	25	---
3/8"	<b>AMB</b>	25	<b>ABB</b>	25	<b>RAMB</b>
1/2"	<b>AM2</b>	50	<b>AB2</b> <sup>1</sup>	50	<b>RAM2</b>
3/4"	<b>AM7</b>	50	<b>AB7</b> <sup>1</sup>	50	<b>RAM7</b>
1"	<b>AM12</b>	50	<b>AB12</b> <sup>1</sup>	50	<b>RAM12</b>



**2-Lug Female NPT Ends**

Size	Iron Part #	Optional Qty	Brass Part #	Optional Qty	316 Stainless Steel Part #
1/4"	<b>AMC1</b>	25	<b>ABC1</b>	25	---
3/8"	<b>AMC</b>	25	<b>ABC</b>	25	<b>RAMC</b>
1/2"	<b>AM3</b>	50	<b>AB3</b> <sup>1</sup>	50	<b>RAM3</b>
3/4"	<b>AM8</b>	50	<b>AB8</b> <sup>1</sup>	50	<b>RAM8</b>
1"	<b>AM13</b>	50	<b>AB13</b> <sup>1</sup>	50	<b>RAM13</b>



<sup>1</sup> global investment cast

Air King™ is for air and water service only Warning: Never use any Air King™ coupling for steam service! None of Dixon®'s catalog information is to be interpreted to mean that this type of coupling is suitable for use on steam hose.



## Air King™

## 2-Lug Blank Ends



Iron Part #	Optional Qty	Brass Part #	Optional Qty	316 Stainless Steel Part #
<b>AM0</b>	25	<b>AB0</b> <sup>1</sup>	25	<b>RAM0</b>

## 2-Lug Triple Connections



Iron Part #	Optional Qty	Brass Part #	Optional Qty
<b>AM10</b>	25	<b>AB10</b> <sup>1</sup>	25

<sup>1</sup> global investment cast

## 4-Lug Hose Ends

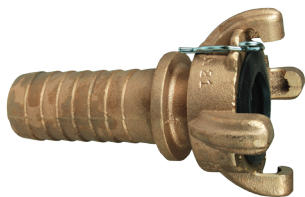

Size	Iron Part #	Brass Part #	Optional Qty
1¼"	<b>AM16</b>	<b>AB16</b> <sup>1</sup>	25
1½"	<b>AM21</b>	<b>AB21</b> <sup>1</sup>	25
2"	<b>AM26</b>	<b>AB26</b>	10

<sup>1</sup> item will be discontinued when stock is depleted

## 4-Lug Female NPT Ends



Size	Iron Part #	Brass Part #	Optional Qty
1¼"	<b>AM18</b>	<b>AB18</b> <sup>1</sup>	25
1½"	<b>AM23</b>	<b>AB23</b> <sup>1</sup>	25
2"	<b>AM28</b>	<b>AB28</b>	10

<sup>1</sup> item will be discontinued when stock is depleted

Air King™ is for air and water service only Warning: Never use any Air King™ coupling for steam service! None of Dixon®'s catalog information is to be interpreted to mean that this type of coupling is suitable for use on steam hose.



Global Air King™

Features:

- supplied with safety clip and rubber washers
- pressure rating: **150 PSI** at ambient temperature **70°F (21°C)**
- use with Boss™ clamps, see pages 75 to 76
- not to be used for steam service 
- must use safety clips, safety clips are same size for both 2-lug and 4-lug Air King™ couplings, see page 289

2-Lug Hose Ends

Size	Plated Steel Part #	Pkg Qty
1/2"	<b>GAM1</b>	25
3/4"	<b>GAM6</b>	50
1"	<b>GAM11</b>	50



2-Lug Male NPT Ends

Size	Plated Steel Part #	Pkg Qty
1/2"	<b>GAM2</b>	25
3/4"	<b>GAM7</b>	50
1"	<b>GAM12</b>	50



2-Lug Female NPT Ends

Size	Plated Steel Part #	Optional Qty
1/2"	<b>GAM3</b>	25
3/4"	<b>GAM8</b>	50
1"	<b>GAM13</b>	50



2-Lug Blank End

Plated Steel Part #	Optional Qty
<b>GAM0</b>	25



2-Lug Triple Connection

Plated Steel Part #	Optional Qty
<b>GAM10</b>	25



Air King™ is for air and water service only Warning: Never use any Air King™ coupling for steam service! None of Dixon®'s catalog information is to be interpreted to mean that this type of coupling is suitable for use on steam hose. 

## Global Air King™

## 4-Lug Hose Ends

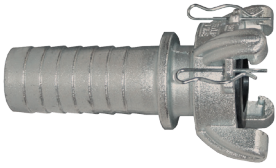

Size	Plated Steel Part #	Optional Qty
1¼"	<b>GAM16</b>	25
1½"	<b>GAM21</b>	25
2"	<b>GAM26</b>	10

## 4-Lug Female NPT Ends



Size	Plated Steel Part #	Optional Qty
1¼"	<b>GAM18</b>	25
1½"	<b>GAM23</b>	25
2"	<b>GAM28</b>	20

Air King™ is for air and water service only Warning: Never use any Air King™ coupling for steam service! None of Dixon®'s catalog information is to be interpreted to mean that this type of coupling is suitable for use on steam hose.





### Air King™ with Ferrule

**Features:**

- working pressure: **150 PSI** at ambient temperature **70°F (21°C)**
- design provides quick, easy and effective coupling of air hose
- interlocking ferrule can be crimped or swaged to achieve maximum coupling sealing and retention with a low profile streamline appearance, for crimp or swage diameter recommendations go to [dixonvalve.com](http://dixonvalve.com)
- for air and water service only



Size	Hose OD		Iron Part #	316 Stainless Steel Part #
	From	To		
1/2"	5/4/64"	1-2/64"	<b>AM1WF</b>	<b>RAM1WF</b>
3/4"	1-4/64"	1-22/64"	<b>AM6WF</b>	<b>RAM6WF</b>
1"	1-18/64"	1-34/64"	<b>AM11WF-1</b>	---
1"	1-30/64"	1-46/64"	<b>AM11WF</b>	---
2"	2-28/64"	2-40/64"	<b>AM26WF</b> <b>NEW</b>	---

### Air King™ with Gauge Port

**Features:**

- drilled with 1/4" NPT port for mounting a gauge
- gauge sold separately



Size	Iron Part #	316 Stainless Steel Part #
3/4"	<b>AM7T</b>	<b>RAM7T</b>

### Air King™ Couplings

#### Swivel Hose End

**Features:**

- working pressure: **150 PSI** at ambient temperature **70°F (21°C)**
- interchanges with other Air King™ fittings
- includes a heavy-duty, free-turning joint that swivels under pressure to prevent hose kinking
- for air and water service only



Size	Iron Part #
3/4"	<b>AM6SWIV</b>

#### Swivel Male NPT Ends

Size	Iron Part #
1/2"	<b>AM2SWIV</b>
3/4"	<b>AM7SWIV</b>



#### Swivel Female NPT End

Size	Iron Part #
3/4"	<b>AM8SWIV</b>



Air King™ is for air and water service only Warning: Never use any Air King™ coupling for steam service! None of Dixon®'s catalog information is to be interpreted to mean that this type of coupling is suitable for use on steam hose.



## Global Air King™ Ferrules

**Features:**

- low profile streamline appearance with maximum retention
- lightweight
- can be crimped
- designed for use with global Air King™ fittings on pages 283 to 284
- reference dixonvalve.com for crimp recommendations and ferrule OD ranges

Size	Ferrule ID	Plated Steel Part #
1/2"	0.906"	<b>CCF0906</b>
3/4"	1.120"	<b>CCF1120</b>
	1.149"	<b>CCF1149</b>
	1.190"	<b>CCF1190</b>
	1.218"	<b>CCF1218</b>
	1.246"	<b>CCF1246</b>
1"	1.438"	<b>CCF1438</b>
	1.469"	<b>CCF1469</b>
	1.500"	<b>CCF1500</b>
	1.531"	<b>CCF1531</b>

## Air King™ Clamps

**Features:**

- Torque values for clamps are based on dry bolts. The use of lubricant on bolts will adversely effect clamp performance.
- for use with Air King™ ends on page 283 to 284



Hose ID	Hose OD		Plated Iron Part #	Torque ft. lbs.	Optional Qty
	from	to			
1/2"	1"	1-12/64"	<b>A4</b>	6	50
3/4"	1-8/64"	1-20/64"	<b>A9</b> <sup>2</sup>	21	50
1"	1-20/64"	1-32/64"	<b>A10</b> <sup>1,2</sup>	21	50
1"	1-32/64"	1-52/64"	<b>A14</b>	21	50

<sup>1</sup> can be used with **AM6** and **AM11**

<sup>2</sup> global investment cast carbon steel

Air King™ Accessories

**Features:**

- The use of an Air King™ safety clip or wire type retainer is necessary to ensure couplings will not become accidentally disconnected. This guarantees the fittings are properly connected as the pin will not go through the holes in the mating flanges until couplings are locked in place.
- only one Air King™ safety clip or wire type retainer is required for each Air King™ universal coupling
- sold in package quantities only

Standard Safety Clip

**Feature:**

- same size clip can be used for all coupling sizes

Wire Diameter	Part #	Pkg Qty
.080	<b>AC1</b>	25



Safety Pins

**Feature:**

- heavy duty, oversized

Wire Diameter	Part #
.058	<b>AKSP1</b>
.091	<b>AKSP25</b>



Synthetic Lanyard

**Features:**

- synthetic cord
- same size for all coupling sizes

Part #	Pkg Qty
<b>ACL8</b>	25



2-Lug Washers

**Features:**

- 2 lug couplings use the same size washer, part #'s **AWR4**, **AWS6**
- rubber temperature range: **-20°F to 160°F (-29°C to 71°C)**
- neoprene temperature range: **-20°F to 190°F (-29°C to 88°C)**
- neoprene is oil resistant

Material	Style	Part #	Pkg Qty
<i>rubber</i>	2 lug	<b>AWR4<sup>1</sup></b>	50
<i>neoprene</i>	2 lug	<b>AWS6</b>	50



AWR4



AWS6

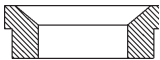

<sup>1</sup> made from Styrene-butadiene (SBR)

4-Lug Washer

**Features:**

- rubber temperature range: **-20°F to 160°F (-29°C to 71°C)**
- 4 lug couplings use the same size washer, part # **AWR14**

Material	Style	Part #
<i>rubber</i>	4 lug	<b>AWR14</b>



Sand Blast Couplings

Features:

- designed for use on sand blast hose
- supplied with screws
- nozzle holders have 1¼" NPSM thread
- pressure: 110 PSI at ambient temperature **70°F (21°C)**
- abrasive blasting equipment must have hose safety cables (page 362) or hose coupling safety locks installed to read safety clips



Installation:

- 1) Ends of hose must be cut square to fit snug against metal end.
- 2) Holding hose tight to end of fitting, insert screws and turn in full, putting screw 180° from first to ensure best centering.
- 3) After all screws have been placed, check tube opposite screws to be sure screws have not penetrated completely through.
- 4) On quick couplings, insert safety clips

Hose Ends



Hose Size	Hose OD	Brass Part #	Aluminum Part #
¾"	1-1/2"	<b>BSB75</b>	<b>ASB75</b>
1"	1-7/8"	<b>BSB100</b>	<b>ASB100</b>
1¼"	2-5/32"	<b>BSB125</b>	<b>ASB125</b>
1½"	2-3/8"	<b>BSB150</b>	<b>ASB150</b>

Nozzle Holders



Hose Size	Hose OD	Brass Part #	Aluminum Part #
¾"	1-1/2"	<b>BNH75</b>	<b>ANH75</b>
1"	1-7/8"	<b>BNH100</b>	<b>ANH100</b>
1¼"	2-5/32"	<b>BNH125</b>	<b>ANH125</b>
1½"	2-3/8"	<b>BNH150</b>	<b>ANH150</b>

Female Threaded Ends



Hose Size	Brass Part #	Aluminum Part #
1¼"	<b>BSC125</b>	<b>ASC125</b>
1½"	<b>BSC150</b>	<b>ASC150</b>

- does not include screws

Replacement Parts



black nitrile



urethane

Description	Part #
<i>black nitrile</i> replacement gasket	<b>SBG</b>
<i>urethane</i> replacement gasket	<b>USBG</b>
replacement screws for sand blast couplings (sold in package quantity of 8 only)	<b>SBCS</b>

Surelock™ Couplings

**Applications:**

- multi-purpose coupling for water and air, commonly used in construction and mining; excels in services where ease, economy, safety and speed are paramount

**Features:**

- pressure activated gasket allows for easy coupling (less than 15 lbs. of force is required to connect the coupling gaskets seal upon introduction of line pressure)
- working pressure: **200 PSI** at ambient temperature **70°F (21°C)**
- body: SG iron AS1831 400-250-12
- bellow seal: natural rubber (patent pending), other seal material available upon request
- safety pin is supplied with each coupling and is required as a safety precaution



**Hose Ends**

Head	Size	Part#	Optional Qty
small	3/8"	<b>SL038H</b>	50
	1/2"	<b>SL050H</b>	50
	3/4"	<b>SL075H</b>	50
	1"	<b>SL100H</b>	50
medium	1 1/2"	<b>SL150H</b>	15
	2"	<b>SL200H</b>	10



**Male NPT Ends**

Head	Size	Part#	Optional Qty
small	3/8"	<b>SL038M</b>	50
	1/2"	<b>SL050M</b>	50
	3/4"	<b>SL075M</b>	50
	1"	<b>SL100M</b>	50
medium	1 1/2"	<b>SL150M</b>	15
	2"	<b>SL200M</b>	15



**Female NPT Ends**

Head	Size	Part#	Optional Qty
small	3/8"	<b>SL038F</b>	50
	1/2"	<b>SL050F</b>	50
	3/4"	<b>SL075F</b>	50
	1"	<b>SL100F</b>	50
medium	1 1/2"	<b>SL150F</b>	15
	2"	<b>SL200F</b>	15



**Hose End with Ferrules**

**Features:**

- design provides quick, easy and effective coupling of air hose
- interlocking ferrule can be crimped or swaged to achieve maximum coupling sealing and retention with a low profile streamline appearance, visit [dixonvalve.com](http://dixonvalve.com) for crimp recommendations
- Dixon® recommends that all hose assemblies be tested in accordance with ARPM testing procedures.
- working pressure: **200 PSI** at ambient temperature **70°F (21°C)**
- for air and water service only



Head	Size	Hose OD		Part #
		From	To	
small	1/2"	1/2"	1-1/32"	<b>SL050CR</b>
	3/4"	3/4"	1-11/32"	<b>SL075CR</b>
	1"	1"	1-23/32"	<b>SL100CR</b>



Surelock™ Couplings  
Blank Ends



small blank end



medium blank end <sup>1</sup>

Head	Size	Part #	Optional Qty
small	½" to 1"	<b>SL00</b>	15
medium	1½" to 2"	<b>SL01</b>	3

<sup>1</sup> medium blank end comes with 1" NPT pipe plug

Three Way Connectors



small three way connector



medium three way connector <sup>1</sup>

Head	Size	Part #	Optional Qty
small	½" to 1"	<b>SL09</b>	15
medium	1½" to 2"	<b>SL10</b>	3

<sup>1</sup> medium three way connector comes with 1" NPT pipe plug

Safety Locking Pin

The use of a safety locking pin is necessary to ensure that Surelock™ couplings will not become accidentally disconnected. This guarantees that the fittings are properly connected as the pin will not go through the holes in both couplings until the couplings are locked into place.



Part #	Optional Qty
<b>SLP1</b>	25

Replacement Seals



medium

Head	Size	Part #
small	½" to 1"	<b>SLR1</b>
medium	1½" to 2"	<b>SLR2</b>

## Dix-Lock™ N-Series Interchange Pneumatic Couplings

**Features:**

- temperature range: **-40°F to 250°F (-40°C to 121°C)**
- pressure rating: 300 PSI in brass, 500 PSI in steel and 303 stainless steel at ambient temperature **70°C (21°C)**
- Bowes Interchange Bayonet Style
- Interchangeable with Bowes 51000-Series, National Series 'B', MacDonald Quick-Action, Campbell Single-Lock
- conforms to MIL-C-3486 and A-A-50431A standards

It is important to be safe when installing quick disconnect couplings into a pneumatic circuit. Never install a pneumatic coupling directly into an air tool, use a piece of hose that is at least 18" long, between the tool and the coupling, to prevent damage to the coupling. To protect the operator, safety devices, such as a safety check valve and safety cable should be installed in case there is a hose or coupling failure. For safety cables and check valves see pages 362 and 556. 

### Female Head x Female Threaded End Couplers

Body Size	Threads	Brass		Steel		303 Stainless Steel		316 Stainless Steel
		Previous Part #	Part #	Previous Part #	Part #	Previous Part #	Part #	Part #
1/2"	3/8"-18 NPTF	QB101	<b>4NF3-B</b>	QM101	<b>4NF3</b>	---	---	---
	3/8"-19 BSPP	---	---	---	<b>4NBF3</b>	---	---	---
	1/2"-14 NPTF	QB102	<b>4NF4-B</b>	QM102	<b>4NF4</b>	---	---	---
	1/2"-14 BSPP	---	<b>4NBF4-B</b>	---	<b>4NBF4</b>	---	---	---
	3/4"-14 NPTF	QB103	<b>4NF6-B</b>	QM103	<b>4NF6</b>	QSS103	<b>4NF6-S</b>	<b>4NF6-SS</b> <b>NEW</b>
	3/4"-14 BSPP	---	<b>4NBF6-B</b>	---	<b>4NBF6</b>	---	---	---
	1"-11 1/2 NPTF	QB105	<b>4NF8-B</b>	QM105	<b>4NF8</b>	---	---	<b>4NF8-SS</b> <b>NEW</b>
	1"-11 BSPP	---	<b>4NBF8-B</b>	---	<b>4NBF8</b>	---	---	---



brass



steel



303/316 stainless

### Male Head x Female Threaded End Plugs

Body Size	Threads	Brass		Steel		303 Stainless Steel		316 Stainless Steel
		Previous Part #	Part #	Previous Part #	Part #	Previous Part #	Part #	Part #
1/2"	3/8"-18 NPTF	QB81	<b>N4F3-B</b>	QM81	<b>N4F3</b>	---	---	---
	3/8"-19 BSPP	---	---	---	<b>N4BF3</b>	---	---	---
	1/2"-14 NPTF	QB82	<b>N4F4-B</b>	QM82	<b>N4F4</b>	---	---	---
	1/2"-14 BSPP	---	<b>N4BF4-B</b>	---	<b>N4BF4</b>	---	---	---
	3/4"-14 NPTF	QB83	<b>N4F6-B</b>	QM83	<b>N4F6</b>	QSS83	<b>N4F6-S</b>	<b>N4F6-SS</b> <b>NEW</b>
	3/4"-14 BSPP	---	<b>N4BF6-B</b>	---	<b>N4BF6</b>	---	---	---
	1"-11 1/2 NPTF	QB85	<b>N4F8-B</b>	QM85	<b>N4F8</b>	---	---	<b>N4F8-SS</b> <b>NEW</b>
	1"-11 BSPP	---	<b>N4BF8-B</b>	---	<b>N4BF8</b>	---	---	---



brass



steel



303/316 stainless

### Male Head x Female Threaded End Safety Lock Plugs

Body Size	Threads	Brass Part #
1/2"	1/2" - 14 NPTF	<b>N4F4-B-LS</b>
	3/4" - 14 NPTF	<b>N4F6-B-LS</b>



Dix-Lock™ N-Series Interchange Pneumatic Couplings

Female Head x Male Threaded End Couplers



303/316 stainless

Body Size	Threads	Brass		Steel		303 Stainless Steel		316 Stainless Steel Part #
		Previous Part #	Part #	Previous Part #	Part #	Previous Part #	Part #	
3/8"	1/2" - 14 NPTF	---	---	QM60	<b>3NM4</b>	---	---	---
	1/2" - 14 BSPT	---	---	---	<b>3NBM4</b>	---	---	---
1/2"	3/8" - 18 NPTF	QB61	<b>4NM3-B</b>	QM61	<b>4NM3</b>	---	---	---
	3/8" - 19 BSPT	---	---	---	<b>4NBM3</b>	---	---	---
	1/2" - 14 NPTF	QB62	<b>4NM4-B</b>	QM62	<b>4NM4</b>	---	---	---
	1/2" - 14 BSPT	---	<b>4NBM4-B</b>	---	<b>4NBM4</b>	---	---	---
	3/4" - 14 NPTF	QB63	<b>4NM6-B</b>	QM63	<b>4NM6</b>	QSS63	<b>4NM6-S</b>	<b>4NM6-SS</b>
	3/4" - 14 BSPT	---	<b>4NBM6-B</b>	---	<b>4NBM6</b>	---	---	---
	1" - 11 1/2 NPTF	QB65	<b>4NM8-B</b>	QM65	<b>4NM8</b>	---	---	<b>4NM8-SS</b>
	1" - 11 BSPT	---	<b>4NBM8-B</b>	---	<b>4NBM8</b>	---	---	---



Male Head x Male Threaded End Plugs

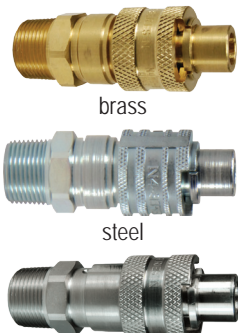

303/316 stainless

Body Size	Threads	Brass		Steel		303 Stainless Steel		316 Stainless Steel Part #
		Previous Part #	Part #	Previous Part #	Part #	Previous Part #	Part #	
3/8"	1/2" - 14 NPTF	---	---	QM40	<b>N3M4</b>	---	---	---
	1/2" - 14 BSPT	---	---	---	<b>N3BM4</b>	---	---	---
1/2"	3/8" - 18 NPTF	QB41	<b>N4M3-B</b>	QM41	<b>N4M3</b>	---	---	---
	3/8" - 19 BSPT	---	---	---	<b>N4BM3</b>	---	---	---
	1/2" - 14 NPTF	QB42	<b>N4M4-B</b>	QM42	<b>N4M4</b>	---	---	---
	1/2" - 14 BSPT	---	<b>N4BM4-B</b>	---	<b>N4BM4</b>	---	---	---
	3/4" - 14 NPTF	QB43	<b>N4M6-B</b>	QM43	<b>N4M6</b>	QSS43	<b>N4M6-S</b>	<b>N4M6-SS</b>
	3/4" - 14 BSPT	---	<b>N4BM6-B</b>	---	<b>N4BM6</b>	---	---	---
	1" - 11 1/2 NPTF	QB45	<b>N4M8-B</b>	QM45	<b>N4M8</b>	---	---	<b>N4M8-SS</b>
	1" - 11 BSPT	---	<b>N4BM8-B</b>	---	<b>N4BM8</b>	---	---	---



Male Head x Male Threaded Safety Lock End Plugs

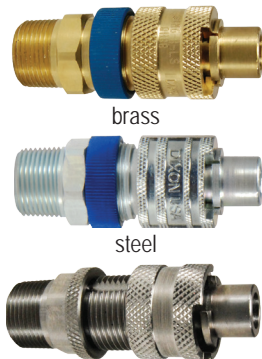

303 stainless

Body Size	Threads	Brass		Steel		303 Stainless Steel Part #
		Previous Part #	Part #	Previous Part #	Part #	
1/2"	1/2" - 14 NPTF	QB66	<b>N4M4-B-LS</b>	QM66	<b>N4M4-LS</b>	---
	1/2" - 14 BSPT	---	---	---	<b>N4BM4-LS</b>	---
	3/4" - 14 NPTF	QB88	<b>N4M6-B-LS</b>	QM88	<b>N4M6-LS</b>	<b>N4M6-S-LS</b>
	3/4" - 14 BSPT	---	---	---	<b>N4BM6-LS</b>	---

Female Head x Standard Hose Barb Couplers



303/316 stainless

Body Size	Hose ID	Brass		Steel		303 Stainless Steel		316 Stainless Steel Part #
		Previous Part #	Part #	Previous Part #	Part #	Previous Part #	Part #	
3/8"	1/2"	---	---	QM20	<b>3NCS4</b>	---	---	---
1/2"	3/8"	QB21	<b>4NS3-B</b>	QM21	<b>4NS3</b>	---	---	---
	1/2"	QB22	<b>4NS4-B</b>	QM22	<b>4NS4</b>	---	---	---
	3/4"	QB23	<b>4NS6-B</b>	QM23	<b>4NS6</b>	QSS23	<b>4NS6-S</b>	<b>4NS6-SS</b>
	1"	QB25	<b>4NS8-B</b>	QM25	<b>4NS8</b>	---	<b>4NS8-S</b>	<b>4NS8-SS</b>





Dix-Lock™ N-Series Interchange Pneumatic Couplings

Male End x Hose Barb Plugs

Body Size	Hose ID	Brass		Steel		303 Stainless Steel		316 Stainless Steel
		Previous Part #	Part #	Previous Part #	Part #	Previous Part #	Part #	Part #
3/8"	1/2"	---	---	QM1	<b>N3CS4</b>	---	---	---
1/2"	3/8"	QB2	<b>N4S3-B</b>	QM2	<b>N4S3</b>	---	---	---
	1/2"	QB3	<b>N4S4-B</b>	QM3	<b>N4S4</b>	---	---	---
	3/4"	QB4	<b>N4S6-B</b>	QM4	<b>N4S6</b>	QSS4	<b>N4S6-S</b>	<b>N4S6-SS</b>
	1"	QB5	<b>N4S8-B</b>	QM5	<b>N4S8</b>	---	<b>N4S8-S</b>	<b>N4S8-SS</b>

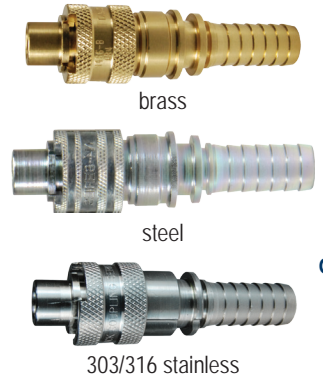

Pneumatic Fittings

Male End x Hose Barb Safety Lock Plugs

Body Size	Hose ID	Previous Part #	Brass	Previous Part #	Steel	303 Stainless Steel
			Part #		Part #	Part #
1/2"	1/2"	QB33	<b>N4S4-B-LS</b>	QM33	<b>N4S4-LS</b>	---
	3/4"	QB44	<b>N4S6-B-LS</b>	QM44	<b>N4S6-LS</b>	<b>N4S6-S-LS</b>

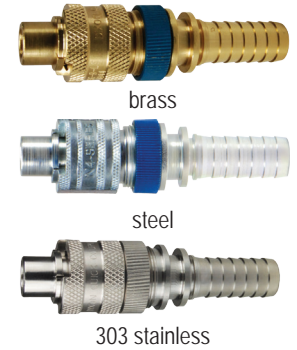

Gender Change Union

Body Size	Configuration	Previous Part #	Steel
			Part #
1/2"	coupler to coupler	QM0	<b>4N4N</b>



Caps

Body Size	Cap Lanyard	Previous Part #	Brass	Previous Part #	Steel
			Part #		Part #
1/2"	steel cable	QBCAP	<b>N4DC-B</b>	QMCAP	<b>N4DC</b>



Seals

Body Size	Coupler Style	Previous Part #	Nitrile	FKM
			Part #	Part #
3/8"	all	QBM1	<b>3N-SKIT</b>	---
1/2"	all	QBM2	<b>4N-SKIT</b>	<b>F-4N-SKIT</b>



## Dix-Lock™ N-Series Interchange Pneumatic Coupler with Ferrule

**Features:**

- working pressure: **300 PSI** at ambient temperature **70°F (21°C)**
- for crimp recommendations visit [dixonvalve.com](http://dixonvalve.com)
- also available in stainless steel, contact Dixon® for further information

**Materials:**

- machined components are manufactured using solid steel, brass, or 303 stainless steel bar stock
- stainless steel retaining ring and spring maximize corrosion resistance and extend service life
- steel componentry is plated using ROHS Compliant Trivalent Chrome

**Interchange Data:**

- Bowes Interchange Bayonet Style
- interchangeable with Bowes 51000-Series, National Series 'B', MacDonald Quick-Action, Campbell Single-Lock

**Seal Components:**

- Nitrile (Buna-N) pneumatically energized seals are standard, temperature range **-40°F to 250°F (-40°C to 121°C)**

### Female Head with Ferrule



Body Size	Hose ID	Hose OD		Plated Steel		Brass	
		From:	To:	Previous Part #	Part #	Previous Part #	Part #
1/2"	1/2"	5/16"	1-2/64"	QM22WF	<b>4NS4-WF</b>	QB22WF	<b>4NS4-B-WF</b>
	3/4"	1-10/64"	1-22/64"	QM23WF	<b>4NS6-WF</b>	QB23WF	<b>4NS6-B-WF</b>

### Male Head with Ferrule



Body Size	Hose ID	Hose OD		Plated Steel		Brass	
		From:	To:	Previous Part #	Part #	Previous Part #	Part #
1/2"	1/2"	5/16"	1-2/64"	QM3WF	<b>N4S4-WF</b>	QB3WF	<b>N4S4-B-WF</b>
	3/4"	1-10/64"	1-22/64"	QM4WF	<b>N4S6-WF</b>	QB4WF	<b>N4S6-B-WF</b>

### Male Locking Head with Ferrule



Body Size	Hose ID	Hose OD		Plated Steel		Brass	
		From:	To:	Previous Part #	Part #	Previous Part #	Part #
1/2"	1/2"	5/16"	1-2/64"	QM33WF	<b>N4S4-LS-WF</b>	QB33WF	<b>N4S4-B-LS-WF</b>
	3/4"	1-10/64"	1-22/64"	QM44WF	<b>N4S6-LS-WF</b>	QB44WF	<b>N4S6-B-LS-WF</b>

## Dual-Lock™ P-Series Pneumatic Couplings

**Features:**

- interchanges with National A type, Campbell Double-Lock and Thor PHC series couplings
- spring loaded interlocking engagement
- optional locking key prevents sleeve retraction
- working pressure: **300 PSI** at ambient temperature **70°F (21°C)**
- Nitrile (Buna-N) seals are standard temperature range **-40°F to 250°F (-40°C to 121°C)**
- steel componentry is plated using ROHS compliant trivalent chrome

### Female Thread Couplers

Body Size	Threads	Brass		Steel		303 Stainless Steel	
		Part #	Previous Part #	Part #	Previous Part #	Part #	Previous Part #
1/2"	1/2" - 14 NPTF	---	PFL8	<b>4PF4</b>	---	---	---
	3/4" - 14 NPTF	<b>4PF6-B</b>	PFL12	<b>4PF6</b>	PFL12SS	<b>4PF6-S</b>	---



brass



steel



303 stainless

### Female Thread Plugs

Body Size	Threads	Brass		Steel		303 Stainless Steel	
		Previous Part #	Part #	Previous Part #	Part #	Previous Part #	Part #
1/2"	3/8" - 18 NPTF	---	---	PF6	<b>P4F3</b>	---	---
	1/2" - 14 NPTF	PFB8	<b>P4F4-B</b>	PF8	<b>P4F4</b>	---	---
	3/4" - 14 NPTF	PFB12	<b>P4F6-B</b>	PF12	<b>P4F6</b>	PF12SS	<b>P4F6-S</b>
	3/4" - 14 NPTF	---	---	---	<b>P4F6-9<sup>1</sup></b>	---	---
	1" - 11 1/2 NPTF	PFB16	<b>P4F8-B</b>	PF16	<b>P4F8</b>	---	---

<sup>1</sup> steel/PTFE coating



brass



steel



303 stainless

### Male Thread Couplers

Body Size	Threads	Steel		303 Stainless Steel	
		Previous Part #	Part #	Previous Part #	Part #
1/2"	3/8" - 18 NPTF	PML6	<b>4PM3</b>	---	---
	1/2" - 14 NPTF	PML8	<b>4PM4</b>	---	---
	3/4" - 14 NPTF	PML12	<b>4PM6</b>	PML12SS	<b>4PM6-S</b>
	3/4" - 14 NPTF	---	<b>4PM6-9<sup>1</sup></b>	---	---
	1" - 11 1/2 NPTF	---	<b>4PM8</b>	---	---

<sup>1</sup> steel/PTFE coating



steel



303 stainless

## Dual-Lock™ P-Series Pneumatic Couplings Male Thread Plugs

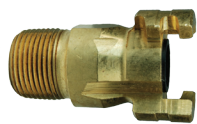

brass

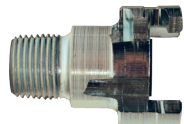

steel



303 stainless

Body Size	Threads	Brass		Steel		303 Stainless Steel	
		Previous Part #	Part #	Previous Part #	Part #	Previous Part #	Part #
1/2"	3/8"-18 NPTF	---	---	PM6	<b>P4M3</b>	---	---
	1/2"-14 NPTF	PMB8	<b>P4M4-B</b>	PM8	<b>P4M4</b>	---	---
	3/4"-14 NPTF	PMB12	<b>P4M6-B</b>	PM12	<b>P4M6</b>	PM12SS	<b>P4M6-S</b>
	3/4"-14 NPTF	---	---	---	<b>P4M6-9<sup>1</sup></b>	---	---
	1"-11 1/2 NPTF	PMB16	<b>P4M8-B</b>	PM16	<b>P4M8</b>	---	---

<sup>1</sup> steel/PTFE coating

### Hose Barb Couplers



brass



steel



303 stainless

Body Size	Hose ID	Brass		Steel		303 Stainless Steel	
		Previous Part #	Part #	Previous Part #	Part #	Previous Part #	Part #
1/2"	3/8"	---	---	PHL6	<b>4PS3</b>	---	---
	1/2"	---	<b>4PS4-B</b>	PHL8	<b>4PS4</b>	---	---
	3/4"	PHLB12	<b>4PS6-B</b>	PHL12	<b>4PS6</b>	PHL12SS	<b>4PS6-S</b>
	3/4"	---	---	---	<b>4PS6-9<sup>1</sup></b>	---	---
	1"	PHLB16	<b>4PS8-B</b>	PHL16	<b>4PS8</b>	---	---

<sup>1</sup> steel/PTFE coating

### Hose Barb Coupler with Knurled Flanged Sleeves

**Feature:**

- large, raised collar sleeve permits easier handling when wearing gloves

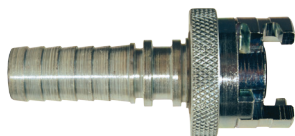

Body Size	Hose ID	Trivalent Chrome Plated Steel	
		Previous Part #	Part #
1/2"	3/8"	PHL6FS	<b>4PS3-FS</b>
	1/2"	PHL8FS	<b>4PS4-FS</b>
	3/4"	PHL12FS	<b>4PS6-FS</b>

### Male Thread Coupler with Knurled Flanged Sleeves



Body Size	Threads	Trivalent Chrome Plated Steel	
		Previous Part #	Part #
1/2"	3/8"-18 NPTF	PML6FS	<b>4PM3-FS</b>
	1/2"-14 NPTF	PML8FS	<b>4PM4-FS</b>
	3/4"-14 NPTF	PML12FS	<b>4PM6-FS</b>

### Female Thread Couplers with Knurled Flanged Sleeves



Body Size	Threads	Trivalent Chrome Plated Steel	
		Previous Part #	Part #
1/2"	1/2"-14 NPTF	PFL8FS	<b>4PF4-FS</b>
	3/4"-14 NPTF	PFL12FS	<b>4PF6-FS</b>

## Dual-Lock™ P-Series Pneumatic Couplings Couplers with Ferrule

**Features:**

- working pressure: **300 PSI** at ambient temperature **70°F (21°C)**
- for crimp recommendations see [dixonvalve.com](http://dixonvalve.com)
- 3/8" and 1" sizes available upon request, contact Dixon®

**Materials:**

- machined components are manufactured using solid steel, brass, or 303 stainless steel bar stock
- stainless steel retaining ring and spring maximize corrosion resistance and extend service life
- steel componentry is plated using ROHS Compliant Trivalent Chrome
- steel couplings have a zinc cast sleeve

**Interchange Data:**

- Thor Finger-Lock Interchange
- Interchanges with Thor PHC-Series, National Series 'A', and Campbell Double-Lock

**Seal Components:**

- Nitrile (Buna-N) seals standard, temperature range **-40°F to 250°F (-40°C to 121°C)**



Body Size	Hose ID	Hose OD		Trivalent Chrome Plated Steel	
		From:	To:	Previous Part #	Part #
1/2"	1/2"	54/64"	1-2/64"	PHL8WF	<b>4PS4-WF</b>
	3/4"	1-10/64"	1-22/64"	PHL12WF	<b>4PS6-WF</b>

## Dual-Lock™ P-Series Pneumatic Couplings

### Replacement Seals

Body Size	Coupler Style	Nitrile	Previous Part #	FKM
		Part #	Part #	Part #
1/2"	all	<b>4P-SKIT</b>	452963	<b>F-4P-SKIT</b>



### Locking Key

Body Size	Coupler Style	Previous Part #	Steel
			Part #
1/2"	all	855231	<b>4P-CLIP</b>



- fits couplings with locking sleeve

## Air Chief Industrial Interchange Couplings

**Features:**

- pressure rating: **300 PSI**
- temperature range: **-40°F to 250°F (-40°C to 121°C)**
- interchanges with many other manufacturer's designs
- interchanges with MIL Spec. MIL-C-4109F/A-A-59439
- for air service only

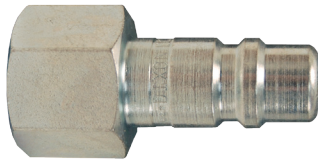
**Female Threaded Plugs**

Body Size	Female NPT	Flow Rating at 100 PSI	Steel Part #
1/4"	1/8"	37 CFM	<b>DCP2021</b>
	1/4"	37 CFM	<b>DCP20</b>
	3/8"	37 CFM	<b>DCP2023</b>
3/8"	1/4"	70 CFM	<b>DCP2622</b>
	3/8"	70 CFM	<b>DCP26</b>
	1/2"	70 CFM	<b>DCP2624</b>
1/2"	3/8"	150 CFM	<b>DCP1823</b>
	1/2"	150 CFM	<b>DCP18</b>
	3/4"	150 CFM	<b>DCP1826</b>
3/4"	1/2"	200 CFM	<b>DCP7024</b>
	3/4"	200 CFM	<b>DCP7026</b>
	1"	200 CFM	<b>DCP7028</b>

**Male Threaded Plugs**

Body Size	Male NPT	Flow Rating at 100 PSI	Steel Part #
1/4"	1/8"	37 CFM	<b>DCP2101</b>
	1/4"	37 CFM	<b>DCP21</b>
	3/8"	37 CFM	<b>DCP2103</b>
3/8"	1/4"	70 CFM	<b>DCP2502</b>
	3/8"	70 CFM	<b>DCP25</b>
	1/2"	70 CFM	<b>DCP2504</b>
1/2"	3/8"	150 CFM	<b>DCP1703</b>
	1/2"	150 CFM	<b>DCP17</b>
	3/4"	150 CFM	<b>DCP1706</b>
3/4"	1/2"	200 CFM	<b>DCP7104</b>
	3/4"	200 CFM	<b>DCP7106</b>
	1"	200 CFM	<b>DCP7108</b>

## Air Chief Industrial Interchange Couplings

## Features:

- pressure rating: **300 PSI**
- temperature range: **-40°F to 250°F (-40°C to 121°C)**
- interchanges with many other manufacturer's designs
- interchanges with MIL Spec. MIL-C-4109F/A-A-59439
- for air service only 

## Standard Hose Barb Plugs

Body Size	Hose ID	Flow Rating at 100 PSI	Steel Part #
1/4"	5/16"	37 CFM	<b>DCP2143</b>
	3/8"	37 CFM	<b>DCP2144</b>
3/8"	1/2"	70 CFM	<b>DCP2545</b>
1/2"	3/4"	150 CFM	<b>DCP1746</b>
	1/2"	200 CFM	<b>DCP7145</b>
3/4"	3/4"	200 CFM	<b>DCP7146</b>
	1"	200 CFM	<b>DCP7148</b>



DCP7145

## Push-On Hose Barb Plugs

Body Size	Hose ID	Flow Rating at 100 PSI	Steel Part #
1/4"	3/8"	37 CFM	<b>DCP2144L</b>
3/8"	1/4"	70 CFM	<b>DCP2542L</b>



F

## Ball Swivel Plug

## Features:

- threaded portion is brass
- plug and nut portion is nickel-plated hardened steel
- pressure rating: **250 PSI**

Body Size	Male NPT	Part #
1/4"	1/4"	<b>DCP21SWIV</b>

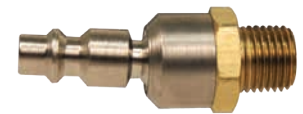

## Dixon® Keychain

## Feature:

- halves separate like a coupler and plug

<i>Plated Steel</i>
Part #
<b>DKC1</b>



## Air Chief Industrial Interchange Couplings

**Features:**

- couplers shut-off when disconnected
- couplers are semi-automatic
- pressure rating: **300 PSI**
- temperature range: **-40°F to 250°F (-40°C to 121°C)**
- interchanges with many other manufacturer's designs
- interchanges with MIL Spec. MIL-C-4109F/A-A-59439
- for air service only 

### Semi-Automatic Female Threaded Couplers

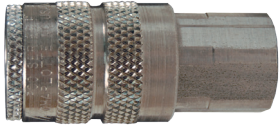

Body Size	Female NPT	Flow Rating at 100 PSI	Brass Part #	Steel Part #
1/4"	1/8"	37 CFM	<b>DC2021</b>	---
	1/4"	37 CFM	<b>DC20</b>	---
	3/8"	37 CFM	<b>DC2023</b>	---
3/8"	1/4"	70 CFM	---	<b>DC2622</b>
	3/8"	70 CFM	---	<b>DC26</b>
	1/2"	70 CFM	---	<b>DC2624</b>
1/2"	3/8"	150 CFM	---	<b>DC1023</b>
	1/2"	150 CFM	---	<b>DC10</b>
	3/4"	150 CFM	---	<b>DC1026</b>

### Male Threaded Couplers

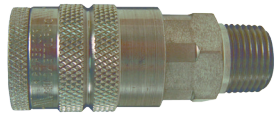

Body Size	Male NPT	Flow Rating at 100 PSI	Brass Part #	Steel Part #
1/4"	1/8"	37 CFM	<b>DC2101</b>	---
	1/4"	37 CFM	<b>DC21</b>	---
	3/8"	37 CFM	<b>DC2103</b>	---
3/8"	1/4"	70 CFM	---	<b>DC2502</b>
	3/8"	70 CFM	---	<b>DC25</b>
	1/2"	70 CFM	---	<b>DC2504</b>
1/2"	3/8"	150 CFM	---	<b>DC903</b>
	1/2"	150 CFM	---	<b>DC9</b>
	3/4"	150 CFM	---	<b>DC906</b>

### Standard Hose Barb Couplers

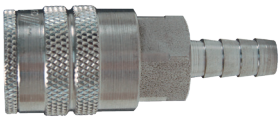

Body Size	Hose ID	Flow Rating at 100 PSI	Brass Part #	Steel Part #
1/4"	1/4"	37 CFM	<b>DC2042</b>	---
	5/16"	37 CFM	<b>DC2043</b>	---
	3/8"	37 CFM	<b>DC2044</b>	---
3/8"	3/8"	70 CFM	---	<b>DC2644</b>
	1/2"	70 CFM	---	<b>DC2645</b>
1/2"	3/8"	150 CFM	---	<b>DC1044</b>
	1/2"	150 CFM	---	<b>DC1045</b>
	3/4"	150 CFM	---	<b>DC1046</b>

### Push-On Hose Barb Couplers

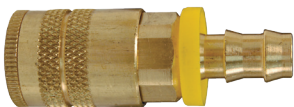

Body Size	Hose ID	Flow Rating at 100 PSI	Brass Part #	Steel Part #
1/4"	1/4"	37 CFM	<b>DC2042L</b>	---
	3/8"	37 CFM	<b>DC2044L</b>	---
3/8"	1/4"	70 CFM	---	<b>DC2642L</b>
	3/8"	70 CFM	---	<b>DC2644L</b>



## Air Chief Industrial Interchange Couplings

**Features:**

- couplers shut-off when disconnected
- couplers are automatic
- pressure rating: **300 PSI**
- temperature range: **-40°F to 250°F (-40°C to 121°C)**
- interchanges with many other manufacturer's designs
- interchanges with MIL Spec. MIL-C-4109F/A-A-59439
- for air service only 

## Automatic

## Female Threaded Couplers

Body Size	Female NPT	Flow Rating at 100 PSI	Brass Part #
3/4"	1/2"	200 CFM	<b>DC7024</b>
	3/4"	200 CFM	<b>DC7026</b>
	1"	200 CFM	<b>DC7028</b>



## Male Threaded Couplers

Body Size	Male NPT	Flow Rating at 100 PSI	Brass Part #
3/4"	1/2"	200 CFM	<b>DC7104</b>
	3/4"	200 CFM	<b>DC7106</b>
	1"	200 CFM	<b>DC7108</b>



## Standard Hose Barb Couplers

Body Size	Hose ID	Flow Rating at 100 PSI	Brass Part #
3/4"	1/2"	200 CFM	<b>DC7045</b>
	3/4"	200 CFM	<b>DC7046</b>
	1"	200 CFM	<b>DC7048</b>

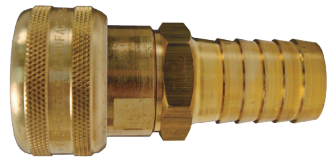

## Parker E-z-mate Industrial Couplings

E-z-mate couplings combine push-to-connect, exhaust-style action with a self-locking valve sleeve to guard against accidental disconnection. Simply follow the direction of the on-off arrow stamped on the yellow chromate valve sleeve. Valve sleeve acts as an integral shut-off valve that allows connection and disconnection at zero pressure. When the sleeve is moved to shut off air flow, it automatically vents downstream allowing for disconnection at zero pressure and eliminating the risk of hose whip.

### Features:

- pressure rating: **300 PSI**
- temperature range (standard seals): **-40°F to +250°F (-40°C to 121°C)**
- meets ISO 4414 requirements for a controlled pressure release system
- not recommended for vacuum service 

### Female Threaded Couplers



Body Size	Female NPT	Flow Rating at 100 PSI	Steel Part #
1/4"	1/4"-18	37 CFM	<b>DC20SE</b>
	3/8"-18	37 CFM	<b>DC2023SE</b>
3/8"	3/8"-18	70 CFM	<b>DC26SE</b>
	1/2"-14	70 CFM	<b>DC2624SE</b>
1/2"	1/2"-14	150 CFM	<b>DC10SE</b>
	3/4"-14	150 CFM	<b>DC1026SE</b>
3/4"	3/4"-14	200 CFM	<b>DC7026SE</b>
	1"-11-1/2	200 CFM	<b>DC7028SE</b>

### Male Threaded Couplers



Body Size	Male NPT	Flow Rating at 100 PSI	Steel Part #
1/4"	1/4"-18	37 CFM	<b>DC21SE</b>
	3/8"-18	37 CFM	<b>DC2103SE</b>
3/8"	3/8"-18	70 CFM	<b>DC25SE</b>
1/2"	1/2"-14	150 CFM	<b>DC9SE</b>
3/4"	3/4"-14	200 CFM	<b>DC7106SE</b>

### Standard Hose Barb Couplers



Body Size	Hose ID	Flow Rating at 100 PSI	Steel Part #
1/4"	1/4"	37 CFM	<b>DC2042SE</b>
	3/8"	37 CFM	<b>DC2044SE</b>
3/8"	3/8"	70 CFM	<b>DC2644SE</b>
1/2"	1/2"	150 CFM	<b>DC1045SE</b>

### Push-Lock Hose Barb Couplers



Body Size	Hose ID	Flow Rating at 100 PSI	Steel Part #
1/4"	1/4"	37 CFM	<b>DC2042LSE</b>
	3/8"	37 CFM	<b>DC2044LSE</b>
3/8"	3/8"	70 CFM	<b>DC2644LSE</b>
1/2"	1/2"	150 CFM	<b>DC1045LSE</b>

## Legris Industrial Interchange Safety Couplers

**Applications:**

- suited for numerous installations including: pneumatic tools, blow guns, pneumatic automotive equipment

**Features:**

- temperature range: **-4°F to 140°F (-40°C to 121°C)**
- working pressure: **230 PSI**
- composite, non-marring body
- 1/4" body size ensures excellent flow and total security due to disconnection in two steps
- compatible with industrial interchange plugs



1. vents plug side



2. disconnects

### Female Threaded Automatic Couplers

Body Size	NPT Size	Part #
1/4"	1/4"	<b>9415U0614</b>
	3/8"	<b>9415U0618</b>

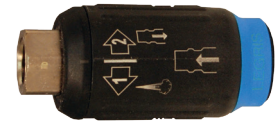

### Male Threaded Automatic Couplers

Body Size	NPT Size	Part #
1/4"	1/4"	<b>9405U0614</b>
	3/8"	<b>9405U0618</b>

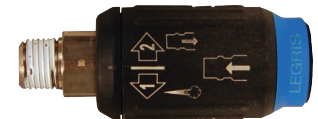

## Air Chief Automotive Interchange Couplings

**Features:**

- pressure rating: **300 PSI**
- temperature range: **-40°F to 250°F (-40°C to 121°C)**
- couplers are semi-automatic
- interchange with popular makes of automotive quick-connect fittings such as Amflo, Dill, Milton and Truflate, some designs do not interchange with others, if you plan to interchange these couplings make sure you have plug ends with the proper configuration

### Semi-Automatic

#### Female Threaded Plugs



Body Size	Female NPT	Flow Rating at 100 PSI	Steel Part #
1/4"	1/8"	37 CFM	<b>DCP221</b>
	1/4"	37 CFM	<b>DCP2</b>
	3/8"	37 CFM	<b>DCP223</b>
3/8"	1/4"	70 CFM	<b>DCP8</b>
	3/8"	70 CFM	<b>DCP6</b>
	1/2"	70 CFM	<b>DCP624</b>

#### Male Threaded Plugs



Body Size	Male NPT	Flow Rating at 100 PSI	Steel Part #
1/4"	1/8"	37 CFM	<b>DCP101</b>
	1/4"	37 CFM	<b>DCP1</b>
	3/8"	37 CFM	<b>DCP103</b>
3/8"	1/4"	70 CFM	<b>DCP7</b>
	3/8"	70 CFM	<b>DCP5</b>

#### Standard Hose Barb Plugs



Body Size	Hose ID	Flow Rating at 100 PSI	Steel Part #
1/4"	1/4"	37 CFM	<b>DCP142</b>
	3/8"	37 CFM	<b>DCP144</b>
3/8"	3/8"	37 CFM	<b>DCP544</b>

#### Push-On Hose Barb Plugs

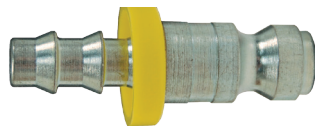

Body Size	Hose ID	Flow Rating at 100 PSI	Steel Part #
1/4"	1/4"	37 CFM	<b>DCP142L</b>
	3/8"	37 CFM	<b>DCP144L</b>
3/8"	3/8"	70 CFM	<b>DCP544L</b>

## Air Chief Automotive Interchange Couplings

**Features:**

- pressure rating: **300 PSI**
- temperature range: **-40°F to 250°F (-40°C to 121°C)**
- couplers are semi-automatic
- interchanges with popular makes of automotive quick-connect fittings such as Amflo, Dill, Milton and Truflate, some makes do not interchange with any others, if you plan to interchange these couplings make sure you have plug ends with the proper configuration

### Semi-Automatic

#### Female Threaded Couplers

Body Size	Female NPT	Flow Rating at 100 PSI	Brass Part #	Steel Part #
1/4"	1/8"	37 CFM	<b>DC221</b>	---
	1/4"	37 CFM	<b>DC2</b>	---
	3/8"	37 CFM	<b>DC223</b>	---
3/8"	1/4"	70 CFM	---	<b>DC8</b>
	3/8"	70 CFM	---	<b>DC6</b>
	1/2"	70 CFM	---	<b>DC624</b>

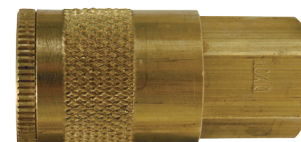

#### Male Threaded Couplers

Body Size	Male NPT	Flow Rating at 100 PSI	Brass Part #	Steel Part #
1/4"	1/8"	37 CFM	<b>DC101</b>	---
	1/4"	37 CFM	<b>DC1</b>	---
	3/8"	37 CFM	<b>DC103</b>	---
3/8"	1/4"	70 CFM	---	<b>DC7</b>
	3/8"	70 CFM	---	<b>DC5</b>
	1/2"	70 CFM	---	<b>DC504</b>

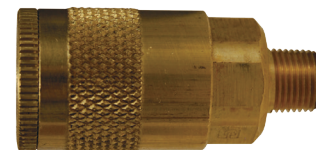

#### Standard Hose Barb Couplers

Body Size	Hose ID	Flow Rating at 100 PSI	Brass Part #	Steel Part #
1/4"	1/4"	37 CFM	<b>DC242</b>	---
	3/8"	37 CFM	<b>DC244</b>	---
3/8"	3/8"	70 CFM	---	<b>DC644</b>
	1/2"	70 CFM	---	<b>DC645</b>



#### Push-On Hose Barb Couplers

Body Size	Hose ID	Flow Rating at 100 PSI	Brass Part #	Steel Part #
1/4"	1/4"	37 CFM	<b>DC242L</b>	---
	3/8"	37 CFM	<b>DC244L</b>	---
3/8"	3/8"	70 CFM	---	<b>DC644L</b>

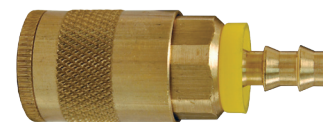

### Air Chief Automotive Actual Size Profile Charts

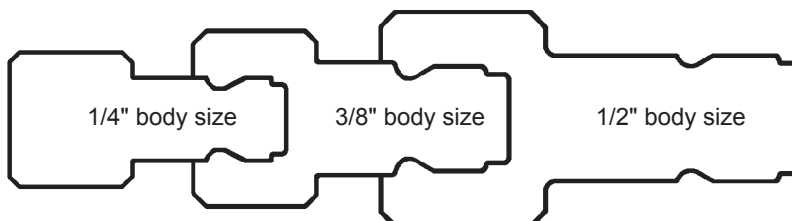

## Air Chief ARO Speed Interchange Couplings

**Features:**

- pressure rating: **300 PSI** at ambient temperature **70°F (21°C)**
- interchanges with ARO 210 and 310 designs
- couplers shut-off when disconnected

### Female Threaded Plugs



Body Size	Female NPT	Flow Rating at 100 PSI	Steel Part #
1/4"	1/4"	37 CFM	<b>DCP38</b>
	3/8"	37 CFM	<b>DCP3823</b>
3/8"	3/8"	70 CFM	<b>DCP36</b>

### Male Threaded Plugs



Body Size	Male NPT	Flow Rating at 100 PSI	Steel Part #
1/4"	1/4"	37 CFM	<b>DCP37</b>
	3/8"	37 CFM	<b>DCP3703</b>
3/8"	3/8"	70 CFM	<b>DCP35</b>

### Standard Hose Barb



Body Size	Hose ID	Flow Rating at 100 PSI	Steel Part #
1/4"	1/4"	37 CFM	<b>DCP3742</b>

### Push-On Hose Barb

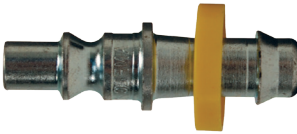

Body Size	Hose ID	Flow Rating at 100 PSI	Steel Part #
1/4"	1/4"	37 CFM	<b>DCP3742L</b>
	3/8"	37 CFM	<b>DCP3744L</b>

### Ball Swivel Plug

**Features:**

- threaded portion is brass
- pressure rating: **250 PSI**

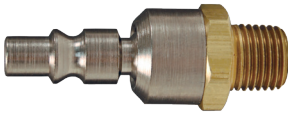

Body Size	Male NPT	Part #
1/4"	1/4"	<b>DCP37SWIV</b>

## Air Chief ARO Speed Interchange Couplings

### Semi-Auto Female Threaded Couplers

Body Size	Hose ID	Flow Rating at 100 PSI	Brass Part #	Steel Part #
1/4"	1/4"	37 CFM	<b>DC38</b>	---
	3/8"	37 CFM	<b>DC3823</b>	---
3/8"	3/8"	70 CFM	---	<b>DC36</b>

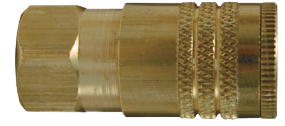

### Semi-Auto Male Threaded Couplers

Body Size	Hose ID	Flow Rating at 100 PSI	Brass Part #	Steel Part #
1/4"	1/4"	37 CFM	<b>DC37</b>	---
	3/8"	37 CFM	<b>DC3703</b>	---
3/8"	3/8"	70 CFM	---	<b>DC35</b>

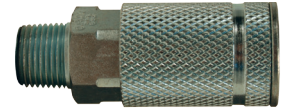

### Semi-Auto Standard Hose Barb Couplers

Body Size	Hose ID	Flow Rating at 100 PSI	Steel Part #
1/4"	1/4"	37 CFM	<b>DC3842</b>
	3/8"	37 CFM	<b>DC3844</b>



### Semi-Auto Push-On Hose Barb Couplers

Body Size	Hose ID	Flow Rating at 100 PSI	Brass Part #
1/4"	1/4"	37 CFM	<b>DC3842L</b>
	3/8"	37 CFM	<b>DC3844L</b>

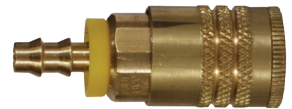

### Air Chief ARO Actual Size Profile Charts

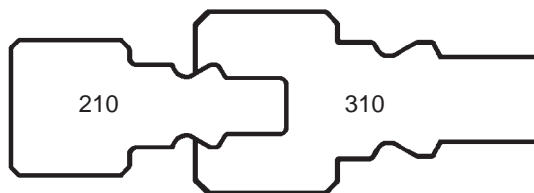

## Air Chief Lincoln Interchange Couplings

**Features:**

- interchangeable with the Lincoln Interchange long stem series
- pressure rating: **300 PSI** at ambient temperature **70°F (21°C)**
- couplers shut-off when disconnected
- couplers are semi-automatic



**Female Threaded Plug**

Body Size	Female NPT	Flow Rating at 100 PSI	Steel Part #
1/4"	1/4"	37 CFM	<b>DCP28</b>



**Male Threaded Plug**

Body Size	Male NPT	Flow Rating at 100 PSI	Steel Part #
1/4"	1/4"	37 CFM	<b>DCP27</b>

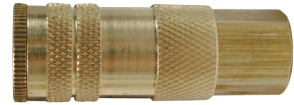

**Female Threaded Coupler**

Body Size	Female NPT	Flow Rating at 100 PSI	Brass Part #
1/4"	1/4"	37 CFM	<b>DC28</b>

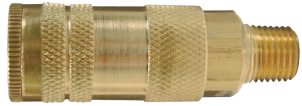

**Male Threaded Coupler**

Body Size	Female NPT	Flow Rating at 100 PSI	Brass Part #
1/4"	1/4"	37 CFM	<b>DC27</b>

### Air Chief Lincoln Actual Size Profile Chart

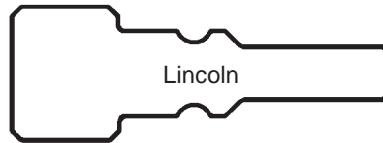



## DF-Series Industrial Pneumatic Couplings

**Features:**

- pressure ratings: brass coupler / steel plug: **500 PSI**, brass coupler / brass plug: **300 PSI**, steel coupler / steel plug: **500 PSI**, 303 stainless steel coupler / 303 stainless steel plug: **500 PSI**
- temperature range: **-40°F to 250°F (-40°C to 121°C)**
- interchanges with other Industrial Interchange designs
- interchanges with the MIL-C-4109, A-A 59439, and ISO6150B standards

It is important to be safe when installing quick disconnect couplings into a pneumatic circuit. Never install a pneumatic coupling directly into an air tool, use a piece of hose that is at least 18" long, between the tool and the coupling, to prevent damage to the coupling. To protect the operator, safety devices, such as a safety check valve and safety cable should be installed in case there is a hose or coupling failure. For safety check valves and cables see pages 362 and 556.

### Female Threaded Plugs

Body Size	Threads	Brass		Steel	303 Stainless Steel	
		Previous Part #	Part #	Part #	Previous Part #	Part #
1/4"	1/8" - 27 NPTF	---	---	<b>D2F1</b>	---	---
	1/4" - 18 NPTF	DCP20B	<b>D2F2-B</b>	<b>D2F2</b>	DCP20S	<b>D2F2-S</b>
	1/4" - 19 BSPP	---	---	<b>D2BF2</b>	---	---
	3/8" - 18 NPTF	DCP2023B	<b>D2F3-B</b>	<b>D2F3</b>	---	<b>D2F3-S</b>
	3/8" - 19 BSPP	---	---	<b>D2BF3</b>	---	---
3/8"	1/4" - 18 NPTF	---	---	<b>D3F2</b>	---	---
	3/8" - 18 NPTF	---	<b>D3F3-B</b>	<b>D3F3</b>	DCP26S	<b>D3F3-S</b>
	3/8" - 19 BSPP	---	---	<b>D3BF3</b>	---	---
	1/2" - 14 NPTF	---	---	<b>D3F4</b>	---	---
1/2"	3/8" - 18 NPTF	---	---	<b>D4F3</b>	---	---
	1/2" - 14 NPTF	---	<b>D4F4-B</b>	<b>D4F4</b>	DCP18S	<b>D4F4-S</b>
	1/2" - 14 BSPP	---	---	<b>D4BF4</b>	---	---
	3/4" - 14 NPTF	---	<b>D4F6-B</b>	<b>D4F6</b>	---	---
3/4"	1/2" - 14 NPTF	---	---	<b>D6F4</b>	---	---
	3/4" - 14 NPTF	---	---	<b>D6F6</b>	---	---
	1" - 11 1/2 NPTF	---	---	<b>D6F8</b>	---	---

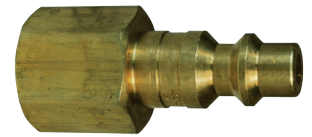

brass



steel

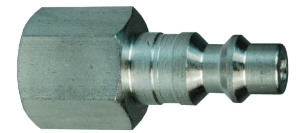

303 stainless

### Male Threaded Plugs

Body Size	Threads	Brass		Steel	303 Stainless Steel	
		Previous Part #	Part #	Part #	Previous Part #	Part #
1/4"	1/8" - 27 NPTF	DCP2101B	<b>D2M1-B</b>	<b>D2M1</b>	---	<b>D2M1-S</b>
	1/4" - 18 NPTF	DCP21B	<b>D2M2-B</b>	<b>D2M2</b>	DCP21S	<b>D2M2-S</b>
	1/4" - 19 BSPT	---	---	<b>D2BM2</b>	---	---
	3/8" - 18 NPTF	DCP2103B	<b>D2M3-B</b>	<b>D2M3</b>	---	<b>D2M3-S</b>
	3/8" - 19 BSPT	---	---	<b>D2BM3</b>	---	---
3/8"	1/4" - 18 NPTF	---	---	<b>D3M2</b>	---	---
	3/8" - 18 NPTF	---	<b>D3M3-B</b>	<b>D3M3</b>	DCP25S	<b>D3M3-S</b>
	3/8" - 19 BSPT	---	---	<b>D3BM3</b>	---	---
	1/2" - 14 NPTF	---	---	<b>D3M4</b>	---	---
1/2"	1/4" - 18 NPTF	---	---	<b>D4M2</b>	---	---
	3/8" - 18 NPTF	---	---	<b>D4M3</b>	---	---
	1/2" - 14 NPTF	---	<b>D4M4-B</b>	<b>D4M4</b>	DCP17S	<b>D4M4-S</b>
	1/2" - 14 BSPT	---	---	<b>D4BM4</b>	---	---
3/4"	3/4" - 14 NPTF	---	<b>D4M6-B</b>	<b>D4M6</b>	---	---
	1/2" - 14 NPTF	---	---	<b>D6M4</b>	---	---
	3/4" - 14 NPTF	---	---	<b>D6M6</b>	---	---
1"	1" - 11 1/2 NPTF	---	---	<b>D6M8</b>	---	---



brass



steel



303 stainless

DF-Series Industrial Pneumatic Couplings

Pneumatic Fittings



brass



steel



303 stainless

Standard Hose Barb Plugs

Body Size	Hose ID	Brass		Steel		303 Stainless Steel	
		Previous Part #	Part #	Previous Part #	Part #	Previous Part #	Part #
1/4"	1/4"	DCP2142B	<b>D2S2-B</b>	DCP2142	<b>D2S2</b>	DCP2142S	<b>D2S2-S</b>
	5/16"	---	---	---	<b>D2S2.5</b>	---	---
	3/8"	DCP2144B	<b>D2S3-B</b>	---	<b>D2S3</b>	---	<b>D2S3-S</b>
3/8"	1/4"	---	---	DCP2542	<b>D3S2</b>	---	---
	3/8"	---	<b>D3S3-B</b>	DCP2544	<b>D3S3</b>	DCP2544S	<b>D3S3-S</b>
	1/2"	---	---	---	<b>D3S4</b>	---	---
1/2"	3/8"	---	<b>D4S3-B</b>	DCP1744	<b>D4S3</b>	---	---
	1/2"	---	<b>D4S4-B</b>	DCP1745	<b>D4S4</b>	DCP1745S	<b>D4S4-S</b>
	3/4"	---	<b>D4S6-B</b>	---	<b>D4S6</b>	---	---
3/4"	1/2"	---	---	---	<b>D6S4</b>	---	---
	3/4"	---	---	---	<b>D6S6</b>	---	---
	1"	---	---	---	<b>D6S8</b>	---	---

Automatic Female Threaded Couplers

Body Size	Threads	Brass		303 Stainless Steel	
		Previous Part #	Part #	Previous Part #	Part #
1/4"	1/8" - 27 NPTF	---	<b>2DF1-B</b>	---	---
	1/4" - 18 NPTF	DCB20	<b>2DF2-B</b>	DCS20	<b>2DF2-S</b>
	1/4" - 19 BSPP	---	<b>2DBF2-B</b>	---	---
	3/8" - 18 NPTF	DCB2023	<b>2DF3-B</b>	---	<b>2DF3-S</b>
	3/8" - 19 BSPP	---	<b>2DBF3-B</b>	---	---
3/8"	1/4" - 18 NPTF	DCB2622	<b>3DF2-B</b>	---	---
	3/8" - 18 NPTF	DCB26	<b>3DF3-B</b>	DCS26	<b>3DF3-S</b>
	3/8" - 19 BSPP	---	<b>3DBF3-B</b>	---	---
	1/2" - 14 NPTF	DCB2624	<b>3DF4-B</b>	---	---
1/2"	3/8" - 18 NPTF	DCB1023	<b>4DF3-B</b>	---	---
	1/2" - 14 NPTF	DCB10	<b>4DF4-B</b>	DCS10	<b>4DF4-S</b>
	1/2" - 14 BSPP	---	<b>4DBF4-B</b>	---	---
	3/4" - 14 NPTF	DCB1026	<b>4DF6-B</b>	---	---
3/4"	1/2" - 14 NPTF	---	<b>6DF4-B</b>	---	---
	3/4" - 14 NPTF	---	<b>6DF6-B</b>	---	---
	1" - 11 1/2 NPTF	---	<b>6DF8-B</b>	---	---

Manual Female Threaded Couplers

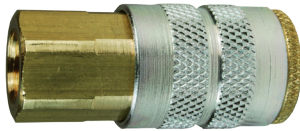

brass



steel



303 stainless

Body Size	Threads	Brass Part #	Steel Part #	303 Stainless Steel	
				Previous Part #	Part #
1/4"	1/8" - 27 NPTF	<b>2FF1-B</b>	---	---	---
	1/8" - 28 BSPP	<b>2FBF1-B</b>	---	---	---
	1/4" - 18 NPTF	<b>2FF2-B</b>	<b>2FF2</b>	DC20S	<b>2FF2-S</b>
	1/4" - 19 BSPP	<b>2FBF2-B</b>	---	---	---
	3/8" - 18 NPTF	<b>2FF3-B</b>	---	---	<b>2FF3-S</b>
	3/8" - 19 BSPP	<b>2FBF3-B</b>	---	---	---
3/8"	1/4" - 18 NPTF	---	<b>3FF2</b>	---	---
	3/8" - 18 NPTF	---	<b>3FF3</b>	DC26S	<b>3FF3-S</b>
	3/8" - 19 BSPP	---	<b>3FBF3</b>	---	---
	1/2" - 14 NPTF	---	<b>3FF4</b>	---	---
1/2"	3/8" - 18 NPTF	---	<b>4FF3</b>	---	---
	1/2" - 14 NPTF	---	<b>4FF4</b>	DC10S	<b>4FF4-S</b>
	1/2" - 14 BSPP	---	<b>4FBF4</b>	---	---
	3/4" - 14 NPTF	---	<b>4FF6</b>	---	---

## DF-Series Industrial Pneumatic Couplings

## Automatic Male Threaded Couplers

Body Size	Threads	Brass		303 Stainless Steel	
		Previous Part #	Part #	Previous Part #	Part #
1/4"	1/8" - 27 NPTF	---	<b>2DM1-B</b>	---	---
	1/4" - 18 NPTF	DCB21	<b>2DM2-B</b>	DCS21	<b>2DM2-S</b>
	1/4" - 19 BSPT	---	<b>2DBM2-B</b>	---	---
	3/8" - 18 NPTF	DCB2103	<b>2DM3-B</b>	---	<b>2DM3-S</b>
	3/8" - 19 BSPT	---	<b>2DBM3-B</b>	---	---
3/8"	1/4" - 18 NPTF	DCB2502	<b>3DM2-B</b>	---	---
	3/8" - 18 NPTF	DCB25	<b>3DM3-B</b>	DCS25	<b>3DM3-S</b>
	3/8" - 19 BSPT	---	<b>3DBM3-B</b>	---	---
	1/2" - 14 NPTF	DCB2504	<b>3DM4-B</b>	---	---
1/2"	3/8" - 18 NPTF	DCB903	<b>4DM3-B</b>	---	---
	1/2" - 14 NPTF	DCB9	<b>4DM4-B</b>	DCS9	<b>4DM4-S</b>
	1/2" - 14 BSPT	---	<b>4DBM4-B</b>	---	---
	3/4" - 14 NPTF	DCB906	<b>4DM6-B</b>	---	---
3/4"	1/2" - 14 NPTF	---	<b>6DM4-B</b>	---	---
	3/4" - 14 NPTF	---	<b>6DM6-B</b>	---	---
	1" - 11 1/2 NPTF	---	<b>6DM8-B</b>	---	---



brass



303 stainless

## Manual Male Threaded Couplers

Body Size	Threads	Brass Part #	Steel Part #	303 Stainless Steel	
				Previous Part #	Part #
1/4"	1/8" - 27 NPTF	<b>2FM1-B</b>	---	---	<b>2FM1-S</b>
	1/4" - 18 NPTF	<b>2FM2-B</b>	<b>2FM2</b>	DC21S	<b>2FM2-S</b>
	1/4" - 19 BSPT	<b>2FBM2-B</b>	---	---	---
	3/8" - 18 NPTF	<b>2FM3-B</b>	---	---	<b>2FM3-S</b>
	3/8" - 19 BSPT	<b>2FBM3-B</b>	---	---	---
3/8"	1/4" - 18 NPTF	---	<b>3FM2</b>	---	---
	3/8" - 18 NPTF	---	<b>3FM3</b>	DC25S	<b>3FM3-S</b>
	3/8" - 19 BSPT	---	<b>3FBM3</b>	---	---
	1/2" - 14 NPTF	---	<b>3FM4</b>	---	---
1/2"	3/8" - 18 NPTF	---	<b>4FM3</b>	---	---
	1/2" - 14 NPTF	---	<b>4FM4</b>	DC9S	<b>4FM4-S</b>
	1/2" - 14 BSPT	---	<b>4FBM4</b>	---	---
	3/4" - 14 NPTF	---	<b>4FM6</b>	---	---



brass

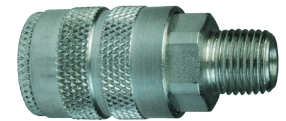

steel



303 stainless

DF-Series Industrial Pneumatic Couplings

Pneumatic Fittings

Automatic Standard Hose Barb Couplers



brass



303 stainless

Body Size	Hose ID	Brass		303 Stainless Steel	
		Previous Part #	Part #	Previous Part #	Part #
1/4"	1/4"	DCB2042	<b>2DS2-B</b>	DCS2042	<b>2DS2-S</b>
	3/8"	DCB2044	<b>2DS3-B</b>	---	<b>2DS3-S</b>
3/8"	1/4"	DCB2642	<b>3DS2-B</b>	---	---
	3/8"	DCB2644	<b>3DS3-B</b>	DCS2644	<b>3DS3-S</b>
	1/2"	DCB2645	<b>3DS4-B</b>	---	---
1/2"	3/8"	DCB1044	<b>4DS3-B</b>	---	---
	1/2"	DCB1045	<b>4DS4-B</b>	DCS1045	<b>4DS4-S</b>
	3/4"	DCB1046	<b>4DS6-B</b>	---	---
3/4"	1/2"	---	<b>6DS4-B</b>	---	---
	3/4"	---	<b>6DS6-B</b>	---	---
	1"	---	<b>6DS8-B</b>	---	---

Manual Standard Hose Barb Couplers



brass



steel



303 stainless

Body Size	Hose ID	Brass	Previous Part #	Steel	303 Stainless Steel	
		Part #		Part #	Previous Part #	Part #
1/4"	1/4"	<b>2FS2-B</b>	---	<b>2FS2</b>	DC2042S	<b>2FS2-S</b>
	5/16"	<b>2FS2.5-B</b>	---	---	---	---
	3/8"	<b>2FS3-B</b>	---	---	---	<b>2FS3-S</b>
3/8"	1/4"	---	DC2642	<b>3FS2</b>	---	---
	3/8"	---	---	<b>3FS3</b>	DC2644S	<b>3FS3-S</b>
	1/2"	---	---	<b>3FS4</b>	---	---
1/2"	3/8"	---	---	<b>4FS3</b>	---	---
	1/2"	---	---	<b>4FS4</b>	DC1045S	<b>4FS4-S</b>
	3/4"	---	---	<b>4FS6</b>	---	---

DF-Series Industrial Pneumatic Couplings  
Automatic Push-Loc Barb Couplers

Body Size	Hose ID	Brass Part #
1/4"	1/4"	<b>2DB2-B</b>
	3/8"	<b>2DB3-B</b>
3/8"	3/8"	<b>3DB3-B</b>
1/2"	1/2"	<b>4DB4-B</b>



Manual Push-Loc Barb Couplers

Body Size	Hose ID	Brass Part #	Steel Part #
1/4"	1/4"	<b>2FB2-B</b>	---
	3/8"	<b>2FB3-B</b>	---
3/8"	1/4"	---	<b>3FB2</b>
	3/8"	---	<b>3FB3</b>
	1/2"	---	<b>3FB4</b>
1/2"	3/8"	---	<b>4FB3</b>
	1/2"	---	<b>4FB4</b>

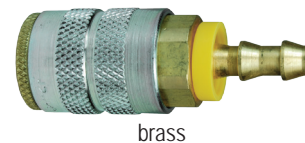

brass



steel

Push-Loc Hose Barb Plugs

Body Size	Hose ID	Brass Part #	Steel	
			Previous Part #	Part #
1/4"	1/4"	<b>D2B2-B</b>	DCP2142L	<b>D2B2</b>
	3/8"	---	---	<b>D2B3</b>
3/8"	1/4"	---	---	<b>D3B2</b>
	3/8"	---	DCP2544L	<b>D3B3</b>
	1/2"	---	---	<b>D3B4</b>
1/2"	1/2"	---	---	<b>D4B4</b>
3/4"	3/4"	---	---	<b>D6B6</b>



brass



steel

Automatic Reusable Barb Couplers

Body Size	Hose ID X OD	Brass Part #
1/4"	1/4" x 1/2"	<b>2DE2-B</b>
	1/4" x 5/8"	<b>2DH2-B</b>
	3/8" x 11/16"	<b>2DK3-B</b>
	3/8" x 3/4"	<b>2DL3-B</b>



Reusable Barb Plugs

Body Size	Hose ID X OD	Steel Part #
1/4"	1/4" x 1/2"	<b>D2E2</b>
	1/4" x 5/8"	<b>D2H2</b>
	3/8" x 11/16"	<b>D2K3</b>
	3/8" x 3/4"	<b>D2L3</b>



DF-Series Actual Size Profile Charts

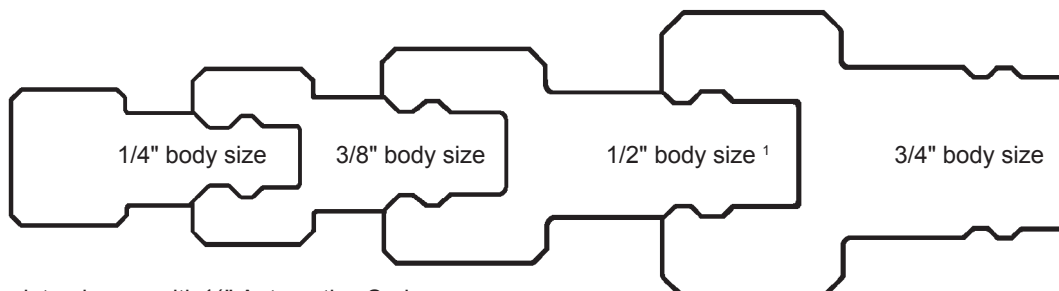

<sup>1</sup> 1/2" may also interchange with 1/2" Automotive Series

## J-Series Automotive Pneumatic Couplings

**Features:**

- pressure rating: Brass Coupler/Steel Plug and Steel Coupler/Steel Plug: **500 PSI**, Brass Coupler/Brass Plug: **300 PSI**
- temperature range: **-40°F to 250°F (-40°C to 121°C)**
- interchanges with other Truflate Automotive designs

Operating pressure for couplings utilizing hose barb end connections may be dramatically reduced to that of the hose rating and/or hose end connection combination. Consult hose manufacturer's catalog for hose end connection ratings. If in doubt, test under controlled conditions for suitability to application. Dixon® cannot assume liability for misapplication of production resulting in equipment down-time, lost production, and/or personal injury including death. 

### Female Threaded Plugs



brass



steel

Body Size	Threads	Brass Part #	Steel Part #
1/4"	1/8" - 27 NPTF	---	<b>J2F1</b>
	1/4" - 18 NPTF	<b>J2F2-B</b>	<b>J2F2</b>
	3/8" - 18 NPTF	---	<b>J2F3</b>
3/8"	1/4" - 18 NPTF	---	<b>J3F2</b>
	3/8" - 18 NPTF	---	<b>J3F3</b>
	1/2" - 14 NPTF	---	<b>J3F4</b>
1/2"	3/8" - 18 NPTF	---	<b>J4F3</b>
	1/2" - 14 NPTF	---	<b>J4F4</b>
	3/4" - 14 NPTF	---	<b>J4F6</b>

### Male Threaded Plugs



brass



steel

Body Size	Threads	Brass Part #	Steel Part #
1/4"	1/8" - 27 NPTF	---	<b>J2M1</b>
	1/4" - 18 NPTF	<b>J2M2-B</b>	<b>J2M2</b>
	3/8" - 18 NPTF	---	<b>J2M3</b>
3/8"	1/4" - 18 NPTF	---	<b>J3M2</b>
	3/8" - 18 NPTF	---	<b>J3M3</b>
	1/2" - 14 NPTF	---	<b>J3M4</b>
1/2"	3/8" - 18 NPTF	---	<b>J4M3</b>
	1/2" - 14 NPTF	---	<b>J4M4</b>
	3/4" - 14 NPTF	---	<b>J4M6</b>

### Standard Hose Barb Plugs



Body Size	Hose ID	Steel	
		Previous Part #	Part #
1/4"	1/4"	---	<b>J2S2</b>
	3/8"	---	<b>J2S3</b>
3/8"	1/4"	DCP542	<b>J3S2</b>
	3/8"	---	<b>J3S3</b>
	1/2"	---	<b>J3S4</b>
1/2"	3/8"	---	<b>J4S3</b>
	1/2"	---	<b>J4S4</b>
	3/4"	---	<b>J4S6</b>

## J-Series Automotive Pneumatic Couplings

### Female Threaded Couplers

Body Size	Threads	Brass Part #	Steel Part #
1/4"	1/8" - 27 NPTF	<b>2JF1-B</b>	---
	1/4" - 18 NPTF	<b>2JF2-B</b>	---
	3/8" - 18 NPTF	<b>2JF3-B</b>	---
3/8"	1/4" - 18 NPTF	---	<b>3JF2</b>
	3/8" - 18 NPTF	---	<b>3JF3</b>
	1/2" - 14 NPTF	---	<b>3JF4</b>

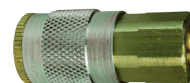

brass



steel

- 1/2" body J-Series plugs are used with 1/2" body DF-Series Manual couplers on page 312

### Male Threaded Couplers

Body Size	Threads	Brass Part #	Steel Part #
1/4"	1/8" - 27 NPTF	<b>2JM1-B</b>	---
	1/4" - 18 NPTF	<b>2JM2-B</b>	---
	3/8" - 18 NPTF	<b>2JM3-B</b>	---
3/8"	1/4" - 18 NPTF	---	<b>3JM2</b>
	3/8" - 18 NPTF	---	<b>3JM3</b>
	1/2" - 14 NPTF	---	<b>3JM4</b>

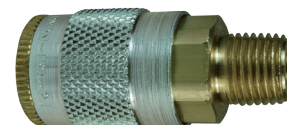

brass

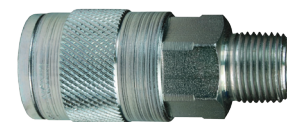

steel

- 1/2" body J-Series plugs are used with 1/2" body DF-Series Manual couplers on page 313

### Standard Hose Barb Couplers

Body Size	Hose ID	Brass Part #	Steel Part #
1/4"	1/4"	<b>2JS2-B</b>	---
	3/8"	<b>2JS3-B</b>	---
3/8"	1/4"	---	<b>3JS2</b>
	3/8"	---	<b>3JS3</b>
	1/2"	---	<b>3JS4</b>



brass



steel

- 1/2" body J-Series plugs are used with 1/2" body DF-Series Manual couplers on page 314

### Push-Loc Hose Barb Couplers

Body Size	Hose ID	Brass Part #	Steel Part #
1/4"	1/4"	<b>2JB2-B</b>	---
	3/8"	<b>2JB3-B</b>	---
3/8"	1/4"	---	<b>3JB2</b>
	3/8"	---	<b>3JB3</b>
	1/2"	---	<b>3JB4</b>

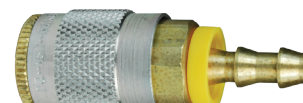

brass

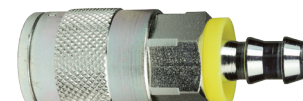

steel

- 1/2" body J-Series plugs are used with 1/2" body DF-Series Manual couplers on page 315

### Push-Loc Hose Barb Plugs

Body Size	Hose ID	Steel Part #
1/4"	1/4"	<b>J2B2</b>
	3/8"	<b>J2B3</b>
3/8"	3/8"	<b>J3B3</b>
1/2"	1/2"	<b>J4B4</b>



## M-Series ARO Pneumatic Couplings

### Features:

- pressure rating: **300 PSI** at ambient temperature **70°F (21°C)**
- automatic couplings interchanges with ARO 210/310 designs and Hansen Series 210/310
- manual couplings interchange with Parker 50-Series and Amflo Type 'B'

It is important to be safe when installing quick disconnect couplings into a pneumatic circuit. Never install a pneumatic coupling directly into an air tool, use a piece of hose that is at least 18" long, between the tool and the coupling, to prevent damage to the coupling. To protect the operator, safety devices, such as a safety check valve and safety cable should be installed in case there is a hose or coupling failure. For safety check valves and cables see pages 362 and 556. 

### Female Threaded Plugs



brass



steel

Body Size	Threads	Brass Part #	Steel Part #
1/4"	1/4" - 18 NPTF	<b>M2F2-B</b>	<b>M2F2</b>
	3/8" - 18 NPTF	---	<b>M2F3</b>
3/8"	3/8" - 18 NPTF	---	<b>M3F3</b>

### Male Threaded Plugs



brass



steel

Body Size	Threads	Brass Part #	Steel Part #
1/4"	1/8" - 27 NPTF	---	<b>M2M1</b>
	1/4" - 18 NPTF	<b>M2M2-B</b>	<b>M2M2</b>
	3/8" - 18 NPTF	---	<b>M2M3</b>
3/8"	3/8" - 18 NPTF	---	<b>M3M3</b>

### Standard Hose Barb Plugs



Body Size	Hose ID	Previous Part #	Steel
			Part #
1/4"	1/4"	---	<b>M2S2</b>
	3/8"	DCP3744	<b>M2S3</b>
3/8"	3/8"	---	<b>M3S3</b>

### Automatic Female Threaded Couplers

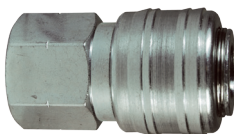

Body Size	Threads	Steel / Brass Part #
1/4"	1/4" - 18 NPT	<b>2MF2-PL</b>
	3/8" - 18 NPT	<b>2MF3-PL</b>
3/8"	3/8" - 18 NPT	<b>3MF3-PL</b>

### Manual Female Threaded Couplers



Body Size	Threads	Brass Part #
1/4"	1/4" - 18 NPT	<b>2MF2-B</b>
	3/8" - 18 NPT	<b>2MF3-B</b>



## M-Series ARO Pneumatic Couplings

## Automatic Male Threaded Couplers

Body Size	Threads	Steel / Brass Part #
1/4"	1/4" - 18 NPT	<b>2MM2-PL</b>
	3/8" - 18 NPT	<b>2MM3-PL</b>
3/8"	3/8" - 18 NPT	<b>3MM3-PL</b>
	1/2" - 14 NPTF	<b>3MM4-PL</b>



## Manual Male Threaded Couplers

Body Size	Threads	Brass Part #
1/4"	1/4" - 18 NPT	<b>2MM2-B</b>
	3/8" - 18 NPT	<b>2MM3-B</b>



## Automatic Standard Hose Barb Couplers

Body Size	Hose ID	Steel / Brass Part #
1/4"	1/4"	<b>2MS2-PL</b>
	5/16"	<b>2MS2.5-PL</b>
	3/8"	<b>2MS3-PL</b>
3/8"	3/8"	<b>3MS3-PL</b>

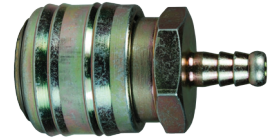

## Manual Standard Hose Barb Couplers

Body Size	Hose ID	Brass Part #
1/4"	1/4"	<b>2MS2-B</b>
	3/8"	<b>2MS3-B</b>



## Push-Loc Barb Plug

Body Size	Hose ID	Steel Part #
1/4"	1/4"	<b>M2B2</b>



## CJ-Series Pneumatic Couplings

**Features:**

- European High-Flow Interchange
- pressure rating: **300 PSI**
- temperature range: **-40°F to 250°F (-40°C to 112°C)**
- 1/4" interchanges with Coilhose Megaflow, CEJN 320, and Rectus 25KA/26KA;
- 3/8" interchanges with Rectus 27KA and CEJN 410

### Female Threaded Plugs

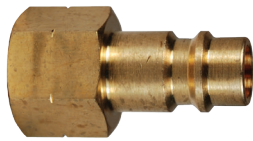

brass

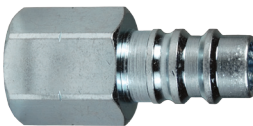

steel

Body Size	Threads	Brass Part #	Steel Part #
1/4"	1/4" - 18 NPT	<b>CJ2F2-B</b>	<b>CJ2F2-LG</b>
	1/4" - 19 BSPP	<b>CJ2BF2-B</b>	<b>CJ2BF2-LG</b>
	3/8" - 18 NPT	<b>CJ2F3-B</b>	<b>CJ2F3-LG</b>
	3/8" - 19 BSPP	<b>CJ2BF3-B</b>	<b>CJ2BF3-LG</b>
3/8"	3/8" - 18 NPT	<b>CJ3F3-B</b>	<b>CJ3F3</b>
	3/8" - 19 BSPP	<b>CJ3BF3-B</b>	<b>CJ3BF3</b>
	1/2" - 14 NPT	<b>CJ3F4-B</b>	---
	1/2" - 14 BSPP	<b>CJ3BF4-B</b>	<b>CJ3BF4</b>

### Male Threaded Plugs



brass



steel

Body Size	Threads	Previous Part #	Brass	Steel
			Part #	Part #
1/4"	1/4" - 18 NPT	DCP41	<b>CJ2M2-B</b>	<b>CJ2M2-LG</b>
	1/4" - 19 BSPT	---	<b>CJ2BM2-B</b>	<b>CJ2BM2-LG</b>
	3/8" - 18 NPT	---	<b>CJ2M3-B</b>	<b>CJ2M3-LG</b>
	3/8" - 19 BSPT	---	<b>CJ2BM3-B</b>	<b>CJ2BM3-LG</b>
3/8"	3/8" - 18 NPT	---	<b>CJ3M3-B</b>	<b>CJ3M3</b>
	3/8" - 19 BSPT	---	<b>CJ3BM3-B</b>	<b>CJ3BM3</b>
	1/2" - 14 NPT	---	<b>CJ3M4-B</b>	<b>CJ3M4</b>
	1/2" - 14 BSPT	---	<b>CJ3BM4-B</b>	<b>CJ3BM4</b>

### Female Threaded Couplers

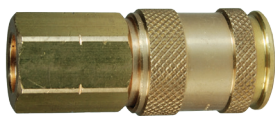

Body Size	Threads	Previous Part #	Brass
			Part #
1/4"	1/4" - 18 NPT	DC41	<b>2CJF2-B</b>
	1/4" - 19 BSPP	---	<b>2CJBF2-B</b>
	3/8" - 18 NPT	---	<b>2CJF3-B</b>
	3/8" - 19 BSPP	---	<b>2CJBF3-B</b>
3/8"	3/8" - 18 NPT	---	<b>3CJF3-B</b>
	3/8" - 19 BSPP	---	<b>3CJBF3-B</b>
	1/2" - 14 NPT	---	<b>3CJF4-B</b>
	1/2" - 14 BSPP	---	<b>3CJBF4-B</b>

### Male Threaded Couplers



Body Size	Threads	Brass Part #
1/4"	1/4" - 18 NPT	<b>2CJM2-B</b>
	1/4" - 19 BSPT	<b>2CJBM2-B</b>
	3/8" - 18 NPT	<b>2CJM3-B</b>
	3/8" - 19 BSPT	<b>2CJBM3-B</b>
3/8"	3/8" - 18 NPT	<b>3CJM3-B</b>
	3/8" - 19 BSPT	<b>3CJBM3-B</b>
	1/2" - 14 NPT	<b>3CJM4-B</b>
	1/2" - 14 BSPT	<b>3CJBM4-B</b>

## SHD-Series Schrader Pneumatic Couplings

## Features:

- pressure rating: **300 PSI**
- temperature range: **-40°F to 250°F (-40°C to 112°C)**
- interchanges with Parker Twist-Lock, Tomco Series-TL, Foster SHD

Operating pressure for couplings utilizing hose barb end connections may be dramatically reduced to that of the hose rating and/or hose end connection combination. Consult hose manufacturer's catalog for hose end connection ratings. If in doubt, test under controlled conditions for suitability to application. Dixon Quick Coupling cannot assume liability for misapplication of production resulting in equipment down-time, lost production, and/or personal injury including death. 

## Female Threaded Plugs

Body Size	Threads	Steel Part #
1/4"	1/8" - 27 NPT	<b>SHD2F1</b>
	1/4" - 18 NPT	<b>SHD2F2</b>
1/2"	3/8" - 18 NPT	<b>SHD4F3</b>



## Male Threaded Plugs

Body Size	Threads	Steel Part #
1/4"	1/8" - 27 NPT	<b>SHD2M1</b>
	1/4" - 18 NPT	<b>SHD2M2</b>
1/2"	3/8" - 18 NPT	<b>SHD4M3</b>
	1/2" - 14 NPT	<b>SHD4M4</b>



## Female Threaded Couplers

Body Size	Threads	Aluminum Part #
1/4"	1/4" - 18 NPT	<b>2SHDF2</b>
	3/8" - 18 NPT	<b>2SHDF3</b>
1/2"	3/8" - 18 NPT	<b>4SHDF3</b>
	1/2" - 14 NPT	<b>4SHDF4</b>
	3/4" - 14 NPT	<b>4SHDF6</b>



## Male Threaded Couplers

Body Size	Threads	Aluminum Part #
1/4"	1/4" - 18 NPT	<b>2SHDM2</b>
	3/8" - 18 NPT	<b>2SHDM3</b>
1/2"	3/8" - 18 NPT	<b>4SHDM3</b>
	1/2" - 14 NPT	<b>4SHDM4</b>

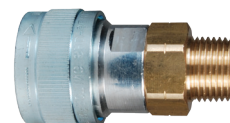

## SHD-Series Schrader Pneumatic Couplings

### Standard Hose Barb Plugs



Body Size	Hose ID	Steel Part #
1/4"	1/4"	<b>SHD2S2</b>
	3/8"	<b>SHD2S3</b>
1/2"	3/8"	<b>SHD4S3</b>
	1/2"	<b>SHD4S4</b>

### Standard Hose Barb Couplers



Body Size	Hose ID	Aluminum Part #
1/4"	1/4"	<b>2SHDS2</b>
	3/8"	<b>2SHDS3</b>
1/2"	3/8"	<b>4SHDS3</b>
	1/2"	<b>4SHDS4</b>

## L-Series Lincoln Pneumatic Couplings

### Features:

- pressure rating: **300 PSI**
- temperature range: **-40°F to 250°F (-40°C to 112°C)**
- Lincoln Long-Nose Automotive Interchange
- interchanges with Parker 70-Series, Tomco Series-1110, Coilhose Type-17

It is important to be safe when installing quick disconnect couplings into a pneumatic circuit. Never install a pneumatic coupling directly into an air tool, use a piece of hose that is at least 18" long, between the tool and the coupling, to prevent damage to the coupling. To protect the operator, safety devices, such as a safety check valve and safety cable should be installed in case there is a hose or coupling failure. For safety check valves and cables see pages 362 and 556. 

### Female Threaded Plug



Body Size	Threads	Steel Part #
1/4"	1/4" - 18 NPT	<b>L2F2</b>

### Male Threaded Plug



Body Size	Threads	Steel Part #
1/4"	1/4" - 18 NPT	<b>L2M2</b>

### Female Threaded Coupler



Body Size	Threads	Brass Part #
1/4"	1/4" - 18 NPT	<b>2LF2-B</b>

### Male Threaded Coupler



Body Size	Threads	Brass Part #
1/4"	1/4" - 18 NPT	<b>2LM2-B</b>

## U-Series Universal Pneumatic Couplings

## Features:

- temperature range: **-40°F to 250°F (-40°C to 112°C)**
- couplers are automatic
- 2U-Series 6-in-1 (Aro 210, Industrial, Truflate, Lincoln, Italian, and CEJN 320)
- 3U-Series 4-in-1 (ARO 310, Industrial, Truflate, and CEJN 410)
- Parker UC-Series, Hansen Auto-Flo 23, and Tomco Series UC
- Although the universal coupler permits multiple series nipples to mate with one coupler, it is recommended to match like series couplers and nipples. When using a Universal coupler, the lower performance rating between the coupler and nipple must take precedence.
- Some pneumatic applications require the pressurized air to be 'dried' to ensure proper operation of equipment and/or application of product (ie. auto body shops). It is best to match like series couplers and nipples in these applications. If it is necessary to use a Universal coupler, lube the seal and valve area regularly to ensure reliable service.
- for air service only 

## Female Threaded Couplers

Body Size	Threads	Brass Part #
1/4"	1/4" - 18 NPT	<b>2UF2-B</b>
	3/8" - 18 NPT	<b>2UF3-B</b>
3/8"	3/8" - 18 NPT	<b>3UF3-B</b>



## Male Threaded Couplers

Body Size	Threads	Brass Part #
1/4"	1/4" - 18 NPT	<b>2UM2-B</b>
	3/8" - 18 NPT	<b>2UM3-B</b>
3/8"	3/8" - 18 NPT	<b>3UM3-B</b>



## Standard Hose Barb Couplers

Body Size	Hose ID	Brass Part #
1/4"	1/4"	<b>2US2-B</b>
	3/8"	<b>2US3-B</b>
3/8"	3/8"	<b>3US3-B</b>



## Push-On Hose Barb Couplers

Body Size	Hose ID	Brass Part #
1/4"	1/4"	<b>2UB2-B</b>
	3/8"	<b>2UB3-B</b>



## NK-Series Japanese Pneumatic Couplings

**Features:**

- Japanese Industrial Interchange Pneumatic Coupling
- Interchanges with Nitto Kohki Hi-Cupla 200, Rectus Series 13, and CEJN Series 315
- Nitrile (Buna-N) seals are standard temperature range **-40°F to 250°F (-40°C to 121°C)**
- pressure rating: **300 PSI**

**Female Threaded Plugs**

Body Size	Threads	Steel Part #
1/4"	1/4" - 18 NPT 1/4" -19 BSPP	<b>NK2F2</b> <b>NK2BF2</b>

**Male Threaded Plugs**

Body Size	Threads	Steel Part #
1/4"	1/4" - 18 NPT 1/4" -19 BSPP	<b>NK2M2</b> <b>NK2BM2</b>

**Hose Barb Plug**

Body Size	Hose ID	Steel Part #
1/4"	1/4"	<b>NK2S2</b>

**Female Threaded Couplers**

Body Size	Threads	Steel Part #
1/4"	1/4" - 18 NPT 1/4" -19 BSPP	<b>2NKF2</b> <b>2NKBF2</b>

**Male Threaded Couplers**

Body Size	Threads	Steel Part #
1/4"	1/4" - 18 NPT 1/4" -19 BSPP	<b>2NKM2</b> <b>2NKBM2</b>

**Hose Barb Coupler**

Body Size	Hose ID	Steel Part #
1/4"	1/4"	<b>2NKS2</b>

## BR-Series Pneumatic Couplings

## Features:

- Interchange data: Rectus 21KA, Tomco Series SC, CEJN Series 223
- Nitrile (Buna-N) seals are standard temperature range **-40°F to 250°F (-40°C to 121°C)**
- pressure rating: **300 PSI**

## Female Threaded Plugs

Body Size	Threads	Brass Part #
1/8"	1/8" - 27 NPT	<b>BR1F1-B-E-7</b> <b>BR1BF1-B-E-7</b> <b>BR1F2-B-E-7</b> <b>BR1BF2-B-E-7</b>
	1/8" - 28 BSPP	
	1/4" - 18 NPT	
	1/4" - 19 BSPP	



## Male Threaded Plugs

Body Size	Threads	Brass Part #
1/8"	1/8" - 27 NPT	<b>BR1M1-B-E-7</b> <b>BR1GM1-B-E-7</b> <b>BR1M2-B-E-7</b> <b>BR1GM2-B-E-7</b>
	1/8" - 28 BSPP	
	1/4" - 18 NPT	
	1/4" - 19 BSPP	



## Female Threaded Couplers

Body Size	Threads	Brass Part #
1/8"	1/8" - 27 NPT	<b>1BRF1-B-7</b> <b>1BRBF1-B-7</b> <b>1BRF2-B-7</b> <b>1BRBF2-B-7</b>
	1/8" - 28 BSPP	
	1/4" - 18 NPT	
	1/4" - 19 BSPP	



## Male Threaded Couplers

Body Size	Threads	Brass Part #
1/8"	1/8" - 27 NPT	<b>1BRM1-B-7</b> <b>1BRGM1-B-7</b> <b>1BRM2-B-7</b> <b>1BRGM2-B-7</b>
	1/8" - 28 BSPP	
	1/4" - 18 NPT	
	1/4" - 19 BSPP	



## Hose Barb Plugs

Body Size	Hose ID	Brass Part #
1/8"	4mm	<b>BR1S1.25-B-E-7</b> <b>BR1S1.86-B-E-7</b> <b>BR1S2.83-B-E-7</b>
	6mm	
	9mm	

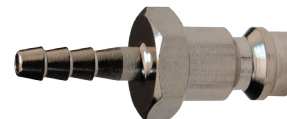

## Hose Barb Couplers

Body Size	Hose ID	Brass Part #
1/8"	4mm	<b>1BRS1.25-B-7</b> <b>1BRS1.86-B-7</b> <b>1BRS2.83-B-7</b>
	6mm	
	9mm	



## A-Series Pneumatic Couplings

**Features:**

- Interchange data: Dixon Quick Coupling Proprietary Astronautics
- Nitrile (Buna-N) seals are standard temperature range **-40°F to 250°F (-40°C to 121°C)**

### Female Threaded Plugs



brass



steel

Body Size	Threads	Brass Part #	Steel Part #
1/8"	1/8" - 27 NPTF	<b>A1F1-B</b>	---
1/4"	1/8" - 27 NPTF	<b>A2F1-B</b>	---
	1/4" - 18 NPTF	<b>A2F2-B</b>	<b>A2F2</b>

### Male Threaded Plugs



brass



steel

Body Size	Threads	Brass Part #	Steel Part #
1/8"	1/8" - 27 NPTF	<b>A1M1-B</b>	---
1/4"	1/4" - 18 NPTF	<b>A2M2-B</b>	<b>A2M2</b>

### Hose Barb Plugs



brass



steel

Body Size	Hose ID	Brass Part #	Steel Part #
1/8"	1/8"	<b>A1S1-B</b>	---
1/4"	1/4"	---	<b>A2S2</b>

### Female Threaded Couplers



Body Size	Threads	Brass Part #
1/8"	1/8" - 27 NPTF	<b>1AF1-B</b>
1/4"	1/8" - 27 NPTF	<b>2AF1-B</b>
	1/4" - 18 NPTF	<b>2AF2-B</b>

### Male Threaded Couplers



Body Size	Threads	Brass Part #
1/8"	1/8" - 27 NPTF	<b>1AM1-B</b>
1/4"	1/8" - 27 NPTF	<b>2AM1-B</b>
	1/4" - 18 NPTF	<b>2AM2-B</b>



A-Series Pneumatic Couplings

Hose Barb Couplers

Body Size	Hose ID	Brass Part #
1/8"	1/8"	<b>1AS1-B</b>
1/4"	1/4"	<b>2AS2-B</b>



Reusable Barb Plugs

Body Size	Hose ID	Brass Part #	Steel Part #
1/4"	1/4" x 1/2"	<b>A2E2-B</b>	<b>A2E2</b>



brass



steel

Reusable Barb Coupler

Body Size	Hose ID x OD	Brass Part #
1/4"	1/4" x 1/2"	<b>2AE2-B</b>



### 3500 Male Nipples

**Features:**

- working pressure: **600 PSI** at ambient temperature **70°F (21°C)**
- *for air and water service only*
- The constant vibration created by air tools, like air drills and pavement breakers, is destructive to air hose couplings, especially the quick-acting type. To provide protection against coupling breakage and related hazards, Dixon® recommends the use of a whip hose. To construct a whip hose, connect one end of a short (3' to 10') air hose to the air tool using a 3500 type steel nipple. Connect the other end of the hose to the air supply using the standard quick-acting coupling. The heat-treated 3500 nipple will withstand vibration far better than the standard coupling and provide a safer connection. The whip hose should remain permanently connected to the tool.



**Male Threaded**

Hose Size	Male NPT	Zinc Plated Steel Part #	Optional Qty
1/4"	1/8"	<b>3501</b>	100
1/4"	1/4"	<b>3502</b>	100
1/4"	3/8"	<b>3504</b>	100
3/8"	1/4"	<b>3505</b>	100
3/8"	3/8"	<b>3506</b>	100
3/8"	1/2"	<b>3508</b>	100
1/2"	1/4"	<b>3509</b>	100
1/2"	3/8"	<b>3510</b>	100
1/2"	1/2"	<b>3512</b>	100
1/2"	3/4"	<b>3511</b>	50
3/4"	1/2"	<b>3513</b>	50
3/4"	3/4"	<b>3514</b>	50
3/4"	1"	<b>3515</b>	25
1"	3/4"	<b>3516</b>	25
1"	1"	<b>3518</b>	25



**Female Threaded**

Hose Size	Female NPT	Zinc Plated Steel Part #	Optional Qty
1/4"	1/4"	<b>3542</b>	100
3/8"	1/4"	<b>3545</b>	50
3/8"	3/8"	<b>3546</b>	50
1/2"	3/8"	<b>3550</b>	100
1/2"	1/2"	<b>3552</b>	50
3/4"	3/4"	<b>3554</b>	50



**Male Threaded with Ferrule**

**Features:**

- zinc plated steel 3500 nipple with carbon steel ferrule
- can be crimped or swaged-on to achieve maximum coupling sealing and retention, for crimp dimensions see [dixonvalve.com](http://dixonvalve.com)
- low profile, streamline appearance

Hose Size	Male NPT	Hose OD		Steel Part #
		From	To	
3/8"	1/4"	46/64"	50/64"	<b>3505WF</b>
3/8"	1/2"	46/64"	50/64"	<b>3508WF</b>
1/2"	1/4"	54/64"	58/64"	<b>3509WF</b>
1/2"	3/8"	54/64"	58/64"	<b>3510WF</b>
1/2"	3/4"	54/64"	58/64"	<b>3511WF</b>
1/2"	1/2"	54/64"	58/64"	<b>3512WF</b>
3/4"	3/4"	1-10/64"	1-14/64"	<b>3514WF</b>
1"	1"	1-30/64"	1-34/64"	<b>3518WF</b>
1"	1"	1-34/64"	1-38/64"	<b>3518WF2</b>



## Bent Stem Swivels

## Hose Barb

## Features:

- $\frac{7}{8}$ " thread fits the following tool brands: Ingersoll-Rand, Thor, Black & Decker, Harper, Jet, Texas Pneumatic, Kent and Sullair
- $\frac{1}{2}$ " thread fits all tools with  $\frac{1}{2}$ " female NPT thread
- $\frac{1}{2}$ " hose barb
- designed for normal operation at **90 PSI** at ambient temperature **70°F (21°C)**

Description	Steel Part #	Optional Qty
$\frac{7}{8}$ " - 24 thread x $\frac{1}{2}$ " hose barb	<b>ATS7812H</b>	50
$\frac{1}{2}$ " NPT thread x $\frac{1}{2}$ " hose barb	<b>ATS1212H</b>	50



## Female Pipe Thread

## Feature:

- $\frac{7}{8}$ " thread fits most chipping hammers
- $\frac{3}{8}$ " female pipe thread
- designed for normal operation at **90 PSI** at ambient temperature **70°F (21°C)**

Description	Steel Part #	Optional Qty
$\frac{7}{8}$ " - 24 thread x $\frac{3}{8}$ " female NPT	<b>ATS7838F</b>	25



## Male Pipe Thread

## Feature:

- $\frac{7}{8}$ " thread fits most chipping hammers
- $\frac{3}{8}$ " male pipe thread
- designed for normal operation at **90 PSI** at ambient temperature **70°F (21°C)**

Description	Steel Part #	Optional Qty
$\frac{7}{8}$ " - 24 thread x $\frac{3}{8}$ " male NPT	<b>ATS7838M</b>	50



## D.O.T. Push-In Fittings

**Features:**

- materials:
  - body (straights) tube, supports and grippers: brass CA360
  - forged elbows and tees: brass CA377
  - O-ring: Buna-N
- suitable for use up to the maximum working pressure of the plastic tubing used, also suitable for vacuum service
- temperature range: **-40°F to 212°F (-40°C to 100°C)**
- pre-applied thread sealant (Loctite 516®) on all male pipe threads
- compatible tubing: SAE J844
- meets D.O.T FMVSS 571.106 and SAE J1131, SAE J2494-1 and SAE J2494-3

### Male Connectors



Tube OD	Male NPTF	Part #	Pkg Qty
1/4"	1/8"	<b>AQ68DOT4X2</b>	10
1/4"	1/4"	<b>AQ68DOT4X4</b>	10
1/4"	3/8"	<b>AQ68DOT4X6</b>	5
3/8"	1/4"	<b>AQ68DOT6X4</b>	10
3/8"	3/8"	<b>AQ68DOT6X6</b>	10

### Union Connectors



Tube OD	Part #	Pkg Qty
1/4"	<b>AQ62DOT4</b>	10
3/8"	<b>AQ62DOT6</b>	10

### Male Elbows



Tube OD	Male NPTF	Part #	Pkg Qty
1/4"	1/8"	<b>AQ69DOT4X2</b>	10
1/4"	1/4"	<b>AQ69DOT4X4</b>	10
3/8"	1/4"	<b>AQ69DOT6X4</b>	10

### D.O.T. Push-In Male Swivel Elbows



Tube OD	Male NPTF	Part #	Pkg Qty
1/4"	1/8"	<b>AQ69DOTS4X2</b>	10
1/4"	1/4"	<b>AQ69DOTS4X4</b>	10
1/4"	3/8"	<b>AQ69DOTS4X6</b>	10
3/8"	1/4"	<b>AQ69DOTS6X4</b>	10
3/8"	3/8"	<b>AQ69DOTS6X6</b>	5

D.O.T. Push-In Fittings

Male Swivel Run Tees

Tube OD	Male NPTF	Part #	Pkg Qty
1/4"	1/8"	<b>AQ71DOTS4X2</b>	10
1/4"	1/4"	<b>AQ71DOTS4X4</b>	5



Male Swivel Branch Tees

Tube OD	Male NPTF	Part #	Pkg Qty
1/4"	1/8"	<b>AQ72DOTS4X2</b>	10
1/4"	1/4"	<b>AQ72DOTS4X4</b>	5



Union Tees

Tube OD	Part #	Pkg Qty
1/4"	<b>AQ64DOT4</b>	10
3/8"	<b>AQ64DOT6</b>	10



## Legris D.O.T. Push-In Fittings

**Features:**

- materials: composite body, brass collet, stainless steel tube support, brass threads, Buna-N O-ring
- maximum operating pressure: **250 PSI** at ambient temperature
- temperature range: **-40°F to 200°F (-40°C to 93°C)**
- suitable fluids: compressed air only
- complies with the performance requirements of D.O.T FMVSS 571.106 (SAE J1131) and SAE J2494-3
- *These fittings are designed for use on all pneumatic circuits other than air brake assemblies between the frame and axle or between towed and towing vehicle.*



### Male Connectors

Tube OD	Male NPT	Part #	Pkg Qty
5/32"	1/8"	<b>31150411DOT</b>	10
5/32"	1/4"	<b>31150414DOT</b>	10
3/16"	1/8"	<b>31155511DOT</b>	10
3/16"	1/4"	<b>31155514DOT</b>	10
1/4"	1/8"	<b>31155611DOT</b>	10
1/4"	1/4"	<b>31155614DOT</b>	10
1/4"	3/8"	<b>31155618DOT</b>	10
3/8"	1/8"	<b>31156011DOT</b>	10
3/8"	1/4"	<b>31156014DOT</b>	10
3/8"	3/8"	<b>31156018DOT</b>	10
3/8"	1/2"	<b>31156022DOT</b>	10
1/2"	1/4"	<b>31156214DOT</b>	10
1/2"	3/8"	<b>31156218DOT</b>	10
1/2"	1/2"	<b>31156222DOT</b>	10

- meets D.O.T. FMVSS571.106, SAE J2494 and SAE J2494-3



### Female Connectors

Tube OD	Female NPT	Part #	Pkg Qty
5/32"	1/8"	<b>31140411DOT</b>	10
3/16"	1/8"	<b>31145511DOT</b>	10
1/4"	1/8"	<b>31145611DOT</b>	10
1/4"	1/4"	<b>31145614DOT</b>	10
3/8"	1/4"	<b>31146014DOT</b>	10
3/8"	3/8"	<b>31146018DOT</b>	10

- meets D.O.T. FMVSS571.106, SAE J2494 and SAE J2494-3



## Legris D.O.T. Push-In Fittings

## Unions

Tube OD	Part #	Pkg Qty
5/32"	<b>31060400DOT</b> <sup>1,2</sup>	10
3/16"	<b>31065500DOT</b> <sup>1,2</sup>	10
1/4"	<b>31065600DOT</b> <sup>3</sup>	10
3/8"	<b>31066000DOT</b> <sup>3</sup>	10
1/2"	<b>31066200DOT</b> <sup>3</sup>	10

<sup>1</sup> brass body<sup>2</sup> meets D.O.T FMVSS571.106, SAE J2494 and SAE J2494-3<sup>3</sup> meets D.O.T FMVSS571.106, J1131 and SAE2494-3

## Bulkhead Unions

Tube OD	Part #	Pkg Qty
1/4"	<b>31165600DOT</b>	10
3/8"	<b>31166000DOT</b>	10
1/2"	<b>31166200DOT</b>	10

- meets D.O.T. FMVSS571.106, SAE J2494 and SAE J2494-3



## Union Elbows

Tube OD	Part #	Pkg Qty
5/32"	<b>31020400DOT</b> <sup>1</sup>	10
1/4"	<b>31025600DOT</b>	10
3/8"	<b>31026000DOT</b>	10
1/2"	<b>31026200DOT</b>	10

- 5/32" diameter meets D.O.T. FMVSS571.106, SAE J2494 and SAE J2494-3

- 1/4", 3/8" and 1/2" diameters meet D.O.T. FMVSS571.106, J1131 and SAE 2494-3

<sup>1</sup> brass body

## Male Elbows

Tube OD	Male NPT	Part #	Pkg Qty
5/32"	1/8"	<b>31090411DOT</b> <sup>1</sup>	10
3/16"	1/8"	<b>31095511DOT</b> <sup>1</sup>	10
1/4"	1/8"	<b>31095611DOT</b>	10
1/4"	1/4"	<b>31095614DOT</b>	10
1/4"	3/8"	<b>31095618DOT</b>	10
3/8"	1/4"	<b>31096014DOT</b>	10
3/8"	3/8"	<b>31096018DOT</b>	10
3/8"	1/2"	<b>31096022DOT</b>	10
1/2"	1/4"	<b>31096214DOT</b>	10
1/2"	3/8"	<b>31096218DOT</b>	10
1/2"	1/2"	<b>31096222DOT</b>	10

- 5/32" and 3/16" diameter meets D.O.T. FMVSS571.106, SAE J2494 and SAE J2494-3

- 1/4", 3/8" and 1/2" diameters meet D.O.T. FMVSS571.106, J1131 and SAE 2494-3

- fitting can be oriented 360° allowing proper positioning of the fitting

<sup>1</sup> brass body

Legris D.O.T. Push-In Fittings

Reducer



Tube OD	Tube OD	Part #	Pkg Qty
1/4"	3/8"	<b>31665660DOT</b>	10

- meets D.O.T. FMVSS571.106, J1131 and SAE 2494-3

Plug In Elbow



Tube OD	Part #	Pkg Qty
1/4"	<b>31825600DOT</b>	10

- meets D.O.T. FMVSS571.106, J1131 and SAE 2494-3

Male Branch Tees



Tube OD	Male NPT	Part #	Pkg Qty
1/4"	1/8"	<b>31085611DOT</b>	10
1/4"	1/4"	<b>31085614DOT</b>	10
1/4"	3/8"	<b>31085618DOT</b>	10
3/8"	1/4"	<b>31086014DOT</b>	10
3/8"	3/8"	<b>31086018DOT</b>	10
3/8"	1/2"	<b>31086022DOT</b>	10
1/2"	1/4"	<b>31086214DOT</b>	10
1/2"	3/8"	<b>31086218DOT</b>	10
1/2"	1/2"	<b>31086222DOT</b>	10

- 1/4", 3/8" and 1/2" diameters meet D.O.T. FMVSS571.106, J1131 and SAE 2494-3
- fitting can be oriented 360° allowing proper positioning of the fitting

Union Tees



Tube OD	Part #	Pkg Qty
5/32"	<b>31040400DOT<sup>1</sup></b>	10
3/16"	<b>31045500DOT<sup>1</sup></b>	10
1/4"	<b>31045600DOT</b>	10
3/8"	<b>31046000DOT</b>	10
1/2"	<b>31046200DOT</b>	10

- 5/32" and 3/16" diameter meets D.O.T. FMVSS571.106, SAE J2494 and SAE J2494-3
- 1/4", 3/8" and 1/2" diameters meet D.O.T. FMVSS571.106, J1131 and SAE 2494-3

<sup>1</sup> brass body



Legris D.O.T. Push-In Fittings

Legris D.O.T. Push-In Male Run Tees

Tube OD	Male NPT	Part #	Pkg Qty
3/16"	1/8"	<b>31035511DOT<sup>1</sup></b>	10
1/4"	1/8"	<b>31035611DOT</b>	10
1/4"	1/4"	<b>31035614DOT</b>	10
1/4"	3/8"	<b>31035618DOT</b>	10
3/8"	1/4"	<b>31036014DOT</b>	10
3/8"	3/8"	<b>31036018DOT</b>	10
3/8"	1/2"	<b>31036022DOT</b>	10
1/2"	1/4"	<b>31036214DOT</b>	10
1/2"	3/8"	<b>31036218DOT</b>	10
1/2"	1/2"	<b>31036222DOT</b>	10



- 3/16" diameter meets D.O.T. FMVSS571.106, SAE J2494 and SAE J2494-3
  - 1/4", 3/8" and 1/2" diameters meet D.O.T. FMVSS571.106, J1131 and SAE 2494-3
  - fitting can be oriented 360° allowing proper positioning of the fitting
- <sup>1</sup> brass body

Legris D.O.T. Push-In Plug In Run Tee

Tube OD	Part #	Pkg Qty
1/4"	<b>31835600DOT</b>	10



- meets D.O.T. FMVSS571.106, J1131 and SAE 2494-3

Legris D.O.T. Push-In Y Connectors

Tube OD	Male NPT	Part #	Pkg Qty
1/4"	1/8"	<b>31485611DOT</b>	10
1/4"	1/4"	<b>31485614DOT</b>	10



- meets D.O.T. FMVSS571.106, J1131 and SAE 2494-3
- fitting can be oriented 360° allowing proper positioning of the fitting

Legris D.O.T. Push-In Y Unions

Tube OD	Part #	Pkg Qty
1/4"	<b>31405600DOT</b>	10
3/8"	<b>31406000DOT</b>	10



- meets D.O.T. FMVSS571.106, J1131 and SAE 2494-3

## Air Brake Fittings

Pneumatic Fittings

**Application:**

- designed for use in air brake systems or cab controls

**Features:**

- utilize ribbed sleeve for compression and positive grip
- machined from CA360, CA345, or CA377 brass
- pre-applied thread sealant on all male pipe threads
- maximum operating pressure: **150 PSI**
- temperature range: **-40°F to 200°F (-40°C to 93°C)**
- compatible tubing: SAE J844 type A and B
- specifications: meets D.O.T FMVSS 571.106 and SAE J246

**Assembly Instructions:**

- Cut tubing squarely - maximum of 15° angle allowable.
- Check that port or mating part is clean and free of debris.
- Insert tubing into fittings until it bottoms on seat.
- Tighten nut with wrench until one thread remains visible on the fittings body; (this will allow for a number of remakes) or, the nut should be screwed down finger tight, then wrench-tightened as indicated in the chart below.

Tube Size	Turns required to seal from hand tight
3/16"	2½
1/4"	3
3/8" & 1/2"	4
5/8" & 3/4"	3½

### Male Connectors

**Features:**

- ref. SAE 100102 BA
- thread sealant may be white or burnt orange

Tube Size	Pipe Thread	Straight Thread	Part #	Pkg Qty
3/16"	1/16"	5/16"-24	<b>68NAB31VS</b>	25
3/16"	1/8"	5/16"-24	<b>68NAB32VS</b>	50
3/16"	1/4"	5/16"-24	<b>68NAB34VS</b>	25
1/4"	1/8"	7/16"-24	<b>68NAB42VS</b>	50
1/4"	1/4"	7/16"-24	<b>68NAB44VS</b>	50
1/4"	3/8"	7/16"-24	<b>68NAB46VS</b>	10
3/8"	1/8"	17/32"-24	<b>68NAB62VS</b>	25
3/8"	1/4"	17/32"-24	<b>68NAB64VS</b>	25
3/8"	3/8"	17/32"-24	<b>68NAB66VS</b>	25
3/8"	1/2"	17/32"-24	<b>68NAB68VS</b>	25
1/2"	1/4"	11/16"-20	<b>68NAB84VS</b>	10
1/2"	3/8"	11/16"-20	<b>68NAB86VS</b>	25
1/2"	1/2"	11/16"-20	<b>68NAB88VS</b>	25
5/8"	3/8"	13/16"-18	<b>68NAB106VS</b>	10
5/8"	1/2"	13/16"-18	<b>68NAB108VS</b>	10
3/4"	3/8"	1"-18	<b>68NAB126VS</b>	10
3/4"	1/2"	1"-18	<b>68NAB128VS</b>	10
3/4"	3/4"	1"-18	<b>68NAB1212VS</b>	10



F

### Female Connectors

**Feature:**

- ref. SAE 100103 BA

Tube Size	Pipe Thread	Straight Thread	Part #	Pkg Qty
¼"	⅛"	7/16"-24	<b>66NAB42</b>	25
¼"	¼"	7/16"-24	<b>66NAB44</b>	10
⅜"	⅛"	17/32"-24	<b>66NAB62</b>	10
⅜"	¼"	17/32"-24	<b>66NAB64</b>	10
½"	⅜"	11/16"-20	<b>66NAB86<sup>1</sup></b>	10
½"	½"	11/16"-20	<b>66NAB88</b>	10
⅝"	⅜"	13/16"-18	<b>66NAB106</b>	10
⅝"	½"	13/16"-18	<b>66NAB108</b>	10



<sup>1</sup> not full hex as shown

## Air Brake Fittings

## Unions

## Feature:

- ref. SAE 100101

Tube Size	Straight Thread	Part #	Pkg Qty
1/4"	7/16"-24	<b>62NAB4</b>	10
3/8"	17/32"-24	<b>62NAB6</b>	10
1/2"	11/16"-20	<b>62NAB8</b>	10
5/8"	13/16"-18	<b>62NAB10</b>	10
3/4"	1"-18	<b>62NAB12</b>	10



## Bulkhead Unions

Tube Size	Straight Thread	Part #	Pkg Qty
1/4"	7/16"-24	<b>62NABH4</b>	10
3/8"	17/32"-24	<b>62NABH6</b>	10
1/2"	11/16"-20	<b>62NABH8</b>	10



## Bulkhead Unions

Tube Size	Straight Thread	Part #	Pkg Qty
3/16"	5/16"-24	<b>62NBH3</b>	10
1/4"	7/16"-24	<b>62NBH4</b>	10
3/8"	17/32"-24	<b>62NBH6</b>	10
1/2"	11/16"-20	<b>62NBH8</b>	10
5/8"	13/16"-18	<b>62NBH10</b>	10



## Bulkhead Unions

Tube Size	Straight Thread	Part #	Pkg Qty
1/4"	7/16"-24	<b>62NFBH4</b>	10
3/8"	17/32"-24	<b>62NFBH6</b>	10
1/2"	11/16"-20	<b>62NFBH8</b>	10
5/8"	13/16"-18	<b>62NFBH10</b>	10



## Bulkhead Unions

Tube Size	Pipe Thread	Part #	Pkg Qty
1/2"	3/8"	<b>66NBH86</b>	10



## Female Elbows

## Feature:

- ref. SAE 100203 BA

Tube Size	Pipe Thread	Straight Thread	Part #	Pkg Qty
3/16"	1/8"	5/16"-24	<b>70NAB32</b>	25
1/4"	1/8"	7/16"-24	<b>70NAB42</b>	25
1/4"	1/4"	7/16"-24	<b>70NAB44</b>	25
3/8"	1/8"	17/32"-24	<b>70NAB62</b>	10
3/8"	1/4"	17/32"-24	<b>70NAB64</b> <sup>1</sup>	10
3/8"	3/8"	17/32"-24	<b>70NAB66</b>	10
1/2"	3/8"	11/16"-20	<b>70NAB86</b>	10
1/2"	1/2"	11/16"-20	<b>70NAB88</b>	10
5/8"	1/2"	13/16"-18	<b>70NAB108</b>	10



<sup>1</sup> rounded elbow parts not as pictured

## Air Brake Fittings

## Male Elbows

## Features:

- ref. SAE 100202 BA
- thread sealant may be white or burnt orange



Tube Size	Pipe Thread	Straight Thread	Part #	Pkg Qty
3/16"	1/8"	5/16"-24	<b>69NAB32VS</b>	10
3/16"	1/4"	5/16"-24	<b>69NAB34VS</b>	10
1/4"	1/8"	7/16"-24	<b>69NAB42VS</b>	50
1/4"	1/4"	7/16"-24	<b>69NAB44VS</b>	50
1/4"	3/8"	7/16"-24	<b>69NAB46VS</b>	10
3/8"	1/8"	17/32"-24	<b>69NAB62VS</b>	10
3/8"	1/4"	17/32"-24	<b>69NAB64VS</b>	25
3/8"	3/8"	17/32"-24	<b>69NAB66VS</b>	25
3/8"	1/2"	17/32"-24	<b>69NAB68VS</b>	10
1/2"	1/4"	11/16"-20	<b>69NAB84VS</b>	10
1/2"	3/8"	11/16"-20	<b>69NAB86VS</b>	10
1/2"	1/2"	11/16"-20	<b>69NAB88VS</b>	10
5/8"	3/8"	13/16"-18	<b>69NAB106VS</b>	10
5/8"	1/2"	13/16"-18	<b>69NAB108VS</b>	5
3/4"	1/2"	1"-18	<b>69NAB128VS</b>	5
3/4"	3/4"	1"-18	<b>69NAB1212VS</b>	5

## Union Elbows

## Feature:

- ref. SAE 100201 BA



Tube Size	Straight Thread	Part #	Pkg Qty
1/4"	7/16"-24	<b>65NAB4</b>	10
3/8"	17/32"-24	<b>65NAB6</b>	10
1/2"	11/16"-20	<b>65NAB8</b>	10
5/8"	13/16"-18	<b>65NAB10</b>	10

## 45° Elbows

## Features:

- ref. SAE 100302 BA
- thread sealant may be white or burnt orange



Tube Size	Pipe Thread	Straight Thread	Part #	Pkg Qty
1/4"	1/8"	7/16"-24	<b>79NAB42VS</b>	10
1/4"	1/4"	7/16"-24	<b>79NAB44VS</b>	10
3/8"	1/8"	17/32"-24	<b>79NAB62VS</b>	10
3/8"	1/4"	17/32"-24	<b>79NAB64VS</b>	10
3/8"	3/8"	17/32"-24	<b>79NAB66VS</b>	10
3/8"	1/2"	17/32"-24	<b>79NAB68VS</b>	10
1/2"	1/4"	11/16"-20	<b>79NAB84VS</b>	10
1/2"	3/8"	11/16"-20	<b>79NAB86VS</b>	10
1/2"	1/2"	11/16"-20	<b>79NAB88VS</b>	10
5/8"	3/8"	13/16"-18	<b>79NAB106VS</b>	5
5/8"	1/2"	13/16"-18	<b>79NAB108VS</b>	5
3/4"	1/2"	1"-18	<b>79NAB128VS</b>	2

## Air Brake Fittings

## Male Branch Tees

## Features:

- ref. SAE 100425 BA
- thread sealant may be white or burnt orange

Tube Size	Pipe Thread	Straight Thread	Part #	Pkg Qty
3/16"	1/8"	7/16"-24	<b>72NAB32VS</b>	10
1/4"	1/8"	7/16"-24	<b>72NAB42VS</b>	10
1/4"	1/4"	7/16"-24	<b>72NAB44VS</b>	10
3/8"	1/8"	17/32"-24	<b>72NAB62VS</b>	10
3/8"	1/4"	17/32"-24	<b>72NAB64VS</b>	10
3/8"	3/8"	17/32"-24	<b>72NAB66VS</b>	10
1/2"	1/4"	11/16"-20	<b>72NAB84VS</b>	10
1/2"	3/8"	11/16"-20	<b>72NAB86VS</b>	10
1/2"	1/2"	11/16"-20	<b>72NAB88VS</b>	10
5/8"	1/2"	13/16"-18	<b>72NAB108VS</b>	10



## Union Tees

## Feature:

- ref. SAE 100401 BA

Tube Size	Straight Thread	Part #	Pkg Qty
1/4"	7/16"-24	<b>64NAB4</b>	25
3/8"	17/32"-24	<b>64NAB6</b>	10
1/2"	11/16"-20	<b>64NAB8</b>	10
5/8"	13/16"-18	<b>64NAB10</b>	10



## Male Run Tees

## Features:

- ref. SAE 100424 BA
- thread sealant may be white or burnt orange

Tube Size	Pipe Thread	Straight Thread	Part #	Pkg Qty
1/4"	1/8"	7/16"-24	<b>71NAB42VS</b>	10
1/4"	1/4"	7/16"-24	<b>71NAB44VS</b>	10
3/8"	1/4"	17/32"-24	<b>71NAB64VS</b>	10
3/8"	3/8"	17/32"-24	<b>71NAB66VS</b>	10
1/2"	3/8"	11/16"-20	<b>71NAB86VS</b>	10
1/2"	1/2"	11/16"-20	<b>71NAB88VS</b>	10
5/8"	1/2"	13/16"-18	<b>71NAB108VS</b>	5



## Sleeves

## Feature:

- ref. SAE 100115

Tube Size	Part #	Pkg Qty
3/16"	<b>60NAB3</b>	100
1/4"	<b>60NAB4</b>	100
3/8"	<b>60NAB6</b>	100
1/2"	<b>60NAB8</b>	100
5/8"	<b>60NAB10</b>	10
3/4"	<b>60NAB12</b>	50



Air Brake Fittings



**Feature:**  
 • for SAE J844 tubing

**Inserts**

Tube Size	302 / 304 Stainless Steel Part #	Pkg Qty
1/4"	<b>63NAB4</b>	200
3/8"	<b>63NAB6</b>	200
1/2"	<b>63NAB8</b>	100
5/8"	<b>63NAB10</b>	100
3/4"	<b>63NAB12</b>	100

**Nuts**

**Feature:**  
 • ref. SAE 100110



Tube Size	Male NPT	Part #	Pkg Qty
3/16"	5/16"-24	<b>61NAB3</b>	100
1/4"	7/16"-24	<b>61NAB4</b>	100
3/8"	17/32"-24	<b>61NAB6</b>	100
1/2"	11/16"-20	<b>61NAB8</b>	50
5/8"	13/16"-18	<b>61NAB10</b>	25
3/4"	1"-18	<b>61NAB12</b>	25

Air Brake Fittings for Rubber Hose

**Application:**

- for use with SAEJ1402 air brake hose in making hose assemblies

**Features:**

- will meet D.O.T. FMVSS 571-106 standards when used with SAE J1402 Air Brake Hose
- working pressure: up to **225 PSI**
- temperature: **-50°F to 212°F (-46° to 100°C)**

**Assembly Guide:**

1. Slide nut onto hose
2. Slide sleeve onto hose with tapered edge toward fitting body
3. Firmly bottom the hose into fittings
4. Screw nut onto body until it contacts the fittings body's hex

**Hose Springs**



Hose Size	Length	Brass Alloy 360 Part #
3/8"	2.70"	<b>56RBSG-06</b>
1/2"	2.70"	<b>56RBSG-08</b>

**Spring Guard Nuts**



Hose Size	Straight Thread	Brass Alloy 360 Part #
3/8"	31/32"-20	<b>61RBSG-06</b>
1/2"	1-3/32"-20	<b>61RBSG-08</b>

## Air Brake Fittings for Rubber Hose

## Hose Nut with Attached Springs

Hose Size	Length	Brass Alloy 360 Part #
3/8"	3.55"	<b>67RBSG-06</b>
1/2"	3.50"	<b>67RBSG-08</b>

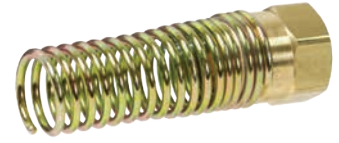

## Male Connectors

Tube OD	Pipe Thread	Straight Thread	Hex	Brass Alloy 360 Part #
3/8"	1/4"	31/32"-20	31/32"	<b>68RB-0604B</b>
3/8"	3/8"	31/32"-20	31/32"	<b>68RB-0606B</b>
3/8"	1/2"	31/32"-20	31/32"	<b>68RB-0608B</b>
1/2"	3/8"	1-3/32"-20	1-1/8"	<b>68RB-0806B</b>
1/2"	1/2"	1-3/32"-20	1-1/8"	<b>68RB-0808B</b>

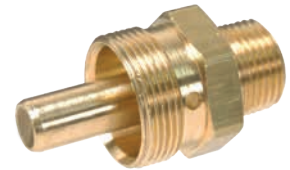

## Male Connector with Spring Guards

Hose Size	Pipe Thread	Hex	Brass Alloy 360 Part #
3/8"	1/4"	1-1/16"	<b>68RBSG-0604</b>
3/8"	3/8"	1-1/16"	<b>68RBSG-0606</b>
3/8"	1/2"	1-1/16"	<b>68RBSG-0608</b>
1/2"	3/8"	1-1/4"	<b>68RBSG-0806</b>
1/2"	1/2"	1-1/4"	<b>68RBSG-0808</b>



## Sleeves

Hose Size	Length	Brass Alloy 360 Part #
3/8"	.64"	<b>60RB-06</b>
1/2"	.64"	<b>60RB-08</b>



## Nuts

Hose Size	Thread	Hex	Brass Alloy 360 Part #
3/8"	31/32"-20	1-1/32"	<b>61RB-06</b>
1/2"	1-3/32"-20	1-1/4"	<b>61RB-08</b>



## Brass Push-In Fittings

**Features:**

- saves up to 75% of assembly time compared to the standard compression fittings
- quick connect: simply push tubing in, no tools required
- quick disconnect: hold two fingers on insert and pull tubing out, no tools required
- reusable: connect and disconnect numerous times
- full flow design provides up to 60% more flow than conventional fittings with internal tube supports
- positive seal: no leaks, after tubing is inserted, seal is made
- secure tube retention: pulling on tubing only serves to tighten the connection
- pre-applied PTFE based pipe sealant on all male pipe threads saves customer additional labor
- working pressure: fittings are suitable for use up to the maximum working pressure of the plastic tubing used also suitable for vacuum service
- temperature range: **-10°F to 200°F (-23°C to 93°C)**

### Male Connectors

Tube OD	Male NPTF	Forged Brass Part #	Optional Qty
1/8"	10-32 <sup>1</sup>	<b>684X10</b>	20
1/8"	1/8"	<b>684X4</b>	20
5/32"	10-32 <sup>1</sup>	<b>685X10</b>	20
5/32"	1/8"	<b>685X4</b>	20
5/32"	1/4"	<b>685X8</b>	10
3/16"	10-32 <sup>1</sup>	<b>686X10</b>	20
3/16"	1/8"	<b>686X4</b>	20
1/4"	10-32 <sup>1</sup>	<b>688X10</b>	20
1/4"	1/8"	<b>688X4</b>	20
1/4"	1/4"	<b>688X8</b>	10
1/4"	3/8"	<b>688X12</b>	10
3/8"	1/8"	<b>6812X4</b>	10
3/8"	1/4"	<b>6812X8</b>	10
3/8"	3/8"	<b>6812X12</b>	10
3/8"	1/2"	<b>6812X16</b>	5
1/2"	1/4"	<b>6816X8</b>	5
1/2"	3/8"	<b>6816X12</b>	5
1/2"	1/2"	<b>6816X16</b>	5

<sup>1</sup> UNF - Straight thread, supplied with gasket

### Female Connectors

Tube OD	Female NPTF	Forged Brass Part #	Optional Qty
1/8"	1/8"	<b>664X4</b>	10
5/32"	1/8"	<b>665X4</b>	10
1/4"	1/8"	<b>668X4</b>	10
1/4"	1/4"	<b>668X8</b>	10
3/8"	1/4"	<b>6612X8</b>	10
3/8"	3/8"	<b>6612X12</b>	5

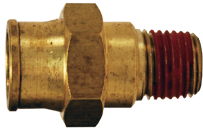



Brass Push-In Fittings

Unions

Tube OD	Forged Brass Part #	Optional Qty
1/8"	<b>624</b>	20
5/32"	<b>625</b>	10
1/4"	<b>628</b>	10
3/8"	<b>6212</b>	10
1/2"	<b>6216</b>	5



Bulkhead Unions

Tube OD	Male NPT	Forged Brass Part #	Optional Qty
1/8"	7/16"-20	<b>824</b>	10
5/32"	7/16"-20	<b>825</b>	10
1/4"	1/2"-20	<b>828</b>	10
3/8"	3/4"-16	<b>8212</b>	5
1/2"	15/16"-16	<b>8216</b>	5



Male Elbows

Tube OD	Male NPTF	Forged Brass Part #	Optional Qty
1/8"	1/8"	<b>694X4</b>	10
5/32"	1/8"	<b>695X4</b>	10
3/16"	1/8"	<b>696X4</b>	10
1/4"	1/4"	<b>698X4</b>	10
1/4"	1/4"	<b>698X8</b>	10
1/4"	3/8"	<b>698X12</b>	10
3/8"	1/8"	<b>6912X4</b>	10
3/8"	1/4"	<b>6912X8</b>	10
3/8"	3/8"	<b>6912X12</b>	10
1/2"	1/4"	<b>6916X8</b>	5
1/2"	3/8"	<b>6916X12</b>	5



Female Elbows

Tube OD	Female NPTF	Forged Brass Part #	Optional Qty
5/32"	1/8"	<b>705X4</b>	10
1/4"	1/8"	<b>708X4</b>	10
1/4"	1/4"	<b>708X8</b>	5
3/8"	1/4"	<b>7012X8</b>	5



Brass Push-In Fittings

Union Elbows



Tube OD	Forged Brass Part #	Optional Qty
1/8"	<b>654</b>	10
5/32"	<b>655</b>	10
1/4"	<b>658</b>	10
3/8"	<b>6512</b>	10
1/2"	<b>6516</b>	5

Male Swivel Elbows



Tube OD	Male NPTF	Forged Brass Part #	Optional Qty
1/8"	1/8"	<b>69S4X4</b>	10
5/32"	10-32 <sup>1</sup>	<b>69S5X10</b>	10
5/32"	1/8"	<b>69S5X4</b>	10
5/32"	1/4"	<b>69S5X8</b>	10
1/4"	10-32 <sup>1</sup>	<b>69S8X10</b>	10
1/4"	1/8"	<b>69S8X4</b>	10
1/4"	1/4"	<b>69S8X8</b>	10
1/4"	3/8"	<b>69S8X12</b>	10
3/8"	1/8"	<b>69S12X4</b>	10
3/8"	1/4"	<b>69S12X8</b>	10
3/8"	3/8"	<b>69S12X12</b>	5
3/8"	1/2"	<b>69S12X16</b>	5
1/2"	3/8"	<b>69S16X12</b>	5
1/2"	1/2"	<b>69S16X16</b>	5

<sup>1</sup> UNF - Straight thread, supplied with gasket

Male Branch Tees



Tube OD	Male NPTF	Forged Brass Part #	Optional Qty
1/8"	1/8"	<b>724X4</b>	10
5/32"	1/8"	<b>725X4</b>	10
1/4"	1/8"	<b>728X4</b>	10
1/4"	1/4"	<b>728X8</b>	5
3/8"	1/8"	<b>7212X4</b>	5
3/8"	1/4"	<b>7212X8</b>	5
3/8"	3/8"	<b>7212X12</b>	5
1/2"	3/8"	<b>7216X12</b>	5

Union Tees



Tube OD	Forged Brass Part #	Optional Qty
1/8"	<b>644</b>	10
5/32"	<b>645</b>	10
3/16"	<b>646</b>	10
1/4"	<b>648</b>	10
3/8"	<b>6412</b>	5
1/2"	<b>6416</b>	5

Brass Push-In Fittings

Male Swivel Branch Tees

Tube OD	Male NPTF	Forged Brass Part #	Optional Qty
1/8"	1/8"	<b>72S4X4</b>	10
5/32"	1/8"	<b>72S5X4</b>	10
1/4"	1/8"	<b>72S8X4</b>	10
1/4"	1/4"	<b>72S8X8</b>	5
3/8"	1/4"	<b>72S12X8</b>	5
3/8"	3/8"	<b>72S12X12</b>	5
1/2"	3/8"	<b>72S16X12</b>	5
1/2"	1/2"	<b>72S16X16</b>	5



Male Run Tees

Tube OD	Male NPTF	Forged Brass Part #	Optional Qty
1/8"	1/8"	<b>714X4</b>	10
5/32"	1/8"	<b>715X4</b>	10
1/4"	1/8"	<b>718X4</b>	10
1/4"	1/4"	<b>718X8</b>	5
3/8"	1/8"	<b>7112X4</b>	5
3/8"	1/4"	<b>7112X8</b>	5
3/8"	3/8"	<b>7112X12</b>	5
1/2"	3/8"	<b>7116X12</b>	5



Male Swivel Run Tees

Tube OD	Male NPTF	Forged Brass Part #	Optional Qty
1/8"	1/8"	<b>71S4X4</b>	10
5/32"	10-32 <sup>1</sup>	<b>71S5X10</b>	10
5/32"	1/8"	<b>71S5X4</b>	5
1/4"	1/8"	<b>71S8X4</b>	5
1/4"	1/4"	<b>71S8X8</b>	5
3/8"	1/4"	<b>71S12X8</b>	5
3/8"	3/8"	<b>71S12X12</b>	5
1/2"	3/8"	<b>71S16X12</b>	5
1/2"	1/2"	<b>71S16X16</b>	5



<sup>1</sup> UNF - Straight thread, supplied with gasket.

## Stainless Steel Legris Push-In Fittings

### Applications:

Suitable for many industries such as: chemical, food, packaging and medical.

### Features:

- temperature range: **-4°F to 245°F (-20°C to 118°C)**
- maximum operating pressure: **290 PSI**
- vacuum capability: 28" HG
- *Maximum circuit pressure depends equally on the type and diameter of the tube used.*
- materials conforming to FDA and 1934/2004 CE standards



### Compatible with a range of tubes:

- semi-rigid nylon tube
- flexible polyurethane tube
- low density polyethylene
- PTFE tube FEP 140
- stainless steel and copper tube (when grooved)

### Materials of Construction:

- body - AISI 316 stainless steel
- backup washer - 316L stainless steel
- collet - 303L stainless steel
- seal - FKM O-ring
- Thread sealant does not come pre-applied on male threads, allowing the appropriate sealant for the application to be applied by the user.
- silicone free

### Straight Male Connectors



Tube OD	Male NPT	Stainless Steel Part #	Pkg Qty
1/4"	1/8"	<b>38055611</b>	10
1/4"	1/4"	<b>38055614</b>	10
3/8"	1/4"	<b>38056014</b>	10
3/8"	3/8"	<b>38056018</b>	10
1/2"	3/8"	<b>38056218</b>	10
1/2"	1/2"	<b>38056222</b>	10

- internal hex allows ease of assembly in tight places

### Unions



Tube OD	Stainless Steel Part #	Pkg Qty
1/4"	<b>38065600</b>	10
3/8"	<b>38066000</b>	10
1/2"	<b>38066200</b>	10

### Bulkhead Connectors Unions



Tube OD	Stainless Steel Part #	Pkg Qty
1/4"	<b>38165600</b>	10
3/8"	<b>38166000</b>	10
1/2"	<b>38166200</b>	10

Stainless Steel Legris Push-In Fittings

Male Elbows

Tube OD	Male NPT	Stainless Steel Part #	Pkg Qty
1/4"	1/8"	<b>38895611</b>	10
1/4"	1/4"	<b>38895614</b>	10
3/8"	1/4"	<b>38896014</b>	10
3/8"	3/8"	<b>38896018</b>	10
1/2"	3/8"	<b>38896218</b>	10
1/2"	1/2"	<b>38896222</b>	10



- body is orientable for positioning purposes

Equal Elbow Unions

Tube OD	Stainless Steel Part #	Pkg Qty
1/4"	<b>38025600</b>	10



Union Tees

Tube OD	Stainless Steel Part #	Pkg Qty
1/4"	<b>38045600</b>	10
3/8"	<b>38046000</b>	10
1/2"	<b>38046200</b>	10



## Nickel-Plated Brass Legris Push-In Fittings

### Applications:

- Push-to-connect forged fittings are nickel plated and have an FKM seal making them suitable to use with liquids and gaseous fluids.
- Fittings are plated with a high phosphorous FDA nickel plate allowing them to be used in applications where exposure to harsh environments is present.
- applications include: food industry, packaging, robotics, pulp and paper and wash down

### Features:

- FDA compliant
- temperature range: **-4°F to 302°F (-20°C to 150°C)**
- pressure range: up to **435 PSI**
- vacuum capability: 28" HG *maximum circuit pressure depends on media, temperature and diameter of tube used*
- full flow
- excellent resistance to abrasion and corrosion
- silicone free
- available in fractional and metric sizes



### Construction:

- body: high phosphorous FDA nickel plated brass
- back-up washer: high phosphorous FDA nickel plated brass
- collet: high phosphorous FDA nickel plated brass
- O-ring: FKM fluoroelastomer conforming to FDA standards
- base: high phosphorous FDA nickel plated brass
- thread sealant is intentionally left off product so the appropriate sealant for the application can be applied

### Male Connectors



Tube OD	Male NPT	Nickel-plated Brass Part #	Optional Qty
5/32"	10-32 <sup>1</sup>	<b>36010420</b>	10
5/32"	1/8"	<b>36750411</b>	10
5/32"	1/4"	<b>36750414</b>	10
1/4"	10-32 <sup>1</sup>	<b>36015620</b>	10
1/4"	1/8"	<b>36755611</b>	10
1/4"	1/4"	<b>36755614</b>	10
1/4"	3/8"	<b>36755618</b>	10
3/8"	1/8"	<b>36756011</b>	10
3/8"	1/4"	<b>36756014</b>	10
3/8"	3/8"	<b>36756018</b>	10
3/8"	1/2"	<b>36756022</b>	10
1/2"	3/8"	<b>36756218</b>	10
1/2"	1/2"	<b>36756222</b>	10

<sup>1</sup> UNF - Straight thread, supplied with gasket and plastic button

### Female Connectors



Tube OD	Female NPT	Nickel-plated Brass Part #	Optional Qty
5/32"	1/4"	<b>36150414</b>	10
1/4"	1/8"	<b>36155611</b>	10
1/4"	1/4"	<b>36155614</b>	10
3/8"	1/4"	<b>36156014</b>	10
3/8"	3/8"	<b>36156018</b>	10
1/2"	3/8"	<b>36156218</b>	10
1/2"	1/2"	<b>36156222</b>	10

### Equal Unions



Tube OD	Nickel-plated Brass Part #	Optional Qty
5/32"	<b>36060400</b>	10
1/4"	<b>36065600</b>	10
3/8"	<b>36066000</b>	10
1/2"	<b>36066200</b>	10

Nickel-Plated Brass Legris Push-In Fittings

Union Elbows

Tube OD	Nickel-plated Brass Part #	Optional Qty
5/32"	<b>36020400</b>	10
1/4"	<b>36025600</b>	10
3/8"	<b>36026000</b>	10
1/2"	<b>36026200</b>	10



Male Elbows

Tube OD	Male NPT	Nickel-plated Brass Part #	Optional Qty
5/32"	10-32 <sup>1</sup>	<b>36990420</b>	10
5/32"	1/8"	<b>36090411</b>	10
5/32"	1/4"	<b>36090414</b>	10
1/4"	1/8"	<b>36095611</b>	10
1/4"	1/4"	<b>36095614</b>	10
1/4"	3/8"	<b>36095618</b>	10
3/8"	1/4"	<b>36096014</b>	10
3/8"	3/8"	<b>36096018</b>	10
3/8"	1/2"	<b>36096022</b>	10
1/2"	1/2"	<b>36096222</b>	10



- <sup>1</sup> UNF - Straight thread, supplied with gasket and plastic button  
 • body is orientable for positioning purposes

Union Tees

Tube OD	Nickel-plated Brass Part #	Optional Qty
5/32"	<b>36040400</b>	10
1/4"	<b>36045600</b>	10
3/8"	<b>36046000</b>	10
1/2"	<b>36046200</b>	10



Male Run Tees

Tube OD	Male NPT	Nickel-plated Brass Part #	Optional Qty
5/32"	10-32 <sup>1</sup>	<b>36930420</b>	10
5/32"	1/8"	<b>36030411</b>	10
5/32"	1/4"	<b>36030414</b>	10
1/4"	1/8"	<b>36035611</b>	10
1/4"	1/4"	<b>36035614</b>	10
1/4"	3/8"	<b>36035618</b>	10
3/8"	1/4"	<b>36036014</b>	10
3/8"	3/8"	<b>36036018</b>	10



- <sup>1</sup> UNF - Straight thread, supplied with gasket and plastic button  
 • body is orientable for positioning purposes

Nylon/Nickel-Plated Brass Legris Push-In Fittings

Pneumatic Fittings Features:

- materials: nickel-plated brass threads; black body is glass-filled nylon; Buna-N D seal; polypropylene release button; silicone free
- positive seal: sealing and holding is accomplished instantaneously
- reusable: connect and disconnect numerous times
- full flow: fitting seals on outside diameter of tubing
- pre-applied thread sealant on all tapered male pipe threads
- compatible tubing: semi-rigid nylon, polyurethane and polyethylene tube
- working pressure: **290 PSI** at ambient temperature.
- *Maximum circuit pressure depends equally on the type and diameter of the tube used.* 
- temperature range: **-4°F to 175°F (-20°C to 79°C)**
- vacuum capability: vacuum of 28" Hg (99% vacuum)

Gripping Ring Technology



Quick Connect and Disconnect:

- To connect, simply push tubing in.
- To disconnect, press the release ring towards the fitting and pull tubing out.
- No tools required.



Male Connectors

Tube OD	Male NPT	Nylon / Nickel-plated Brass Part #	Optional Qty
1/8"	1/16"	<b>31755308</b>	10
1/8"	1/8"	<b>31755311</b>	10
1/8"	1/4"	<b>31755314</b>	10
5/32"	1/8"	<b>31750411</b>	10
5/32"	1/4"	<b>31750414</b>	10
1/4"	1/8"	<b>31755611</b>	10
1/4"	1/4"	<b>31755614</b>	10
1/4"	3/8"	<b>31755618</b>	10
5/16"	1/8"	<b>31750811</b>	10
5/16"	1/4"	<b>31750814</b>	10
5/16"	3/8"	<b>31750818</b>	10
3/8"	1/8"	<b>31756011</b>	10
3/8"	1/4"	<b>31756014</b>	10
3/8"	3/8"	<b>31756018</b>	10
3/8"	1/2"	<b>31756022</b>	10
1/2"	1/4"	<b>31756214</b>	10
1/2"	3/8"	<b>31756218</b>	10
1/2"	1/2"	<b>31756222</b>	10

Female Connectors

Tube OD	Female NPT	Nylon / Nickel-plated Brass Part #	Optional Qty
1/8"	1/8"	<b>30145311</b>	10
1/8"	1/4"	<b>30145314</b>	10
5/32"	1/8"	<b>30140411</b>	10
5/32"	1/4"	<b>30140414</b>	10
1/4"	1/8"	<b>30145611</b>	10
1/4"	1/4"	<b>30145614</b>	10
5/16"	1/8"	<b>30140811</b>	10
5/16"	1/4"	<b>30140814</b>	10
3/8"	1/8"	<b>30146011</b>	10
3/8"	1/4"	<b>30146014</b>	10
3/8"	3/8"	<b>30146018</b>	10



Hybrid Male Connectors

Tube OD	Male BSPT	Nylon / Nickel-plated Brass Part #	Optional Qty
1/4"	1/8"	<b>31755610</b>	10
1/4"	1/4"	<b>31755613</b>	10
3/8"	1/4"	<b>31756013</b>	10





Nylon/Nickel-Plated Brass Legris Push-In Fittings

Female Elbows

Tube OD	Female NPT	Nylon / Nickel-Plated Brass Part #	Optional Qty
1/8"	1/8"	30095311	10
5/32"	1/4"	30090414	10
1/4"	1/8"	30095611	10
1/4"	1/4"	30095614	10
5/16"	1/8"	30090811	10
5/16"	1/4"	30090814	10
3/8"	1/4"	30096014	10
1/2"	3/8"	30096218	10



Male Elbows

Tube OD	Male NPT	Nylon / Nickel Plated Brass Part #	Optional Qty
1/8"	10-32 <sup>1</sup>	31095320	10
1/8"	1/16"	31095308	10
1/8"	1/8"	31095311	10
1/8"	1/4"	31095314	10
5/32"	10-32 <sup>1</sup>	31090420	10
5/32"	1/8"	31090411	10
5/32"	1/4"	31090414	10
1/4"	10-32 <sup>1</sup>	31095620	10
1/4"	1/8"	31095611	10
1/4"	1/4"	31095614	10
1/4"	3/8"	31095618	10
5/16"	1/8"	31090811	10
5/16"	1/4"	31090814	10
5/16"	3/8"	31090818	10
3/8"	1/8"	31096011	10
3/8"	1/4"	31096014	10
3/8"	3/8"	31096018	10
3/8"	1/2"	31096022	10
1/2"	1/4"	31096214	10
1/2"	3/8"	31096218	10
1/2"	1/2"	31096222	10



- <sup>1</sup> UNF - Straight thread, supplied with gasket
- body is orientable for positioning purposes

45° Male Elbows

Tube OD	Male NPT	Nylon / Nickel Plated Brass Part #	Optional Qty
1/4"	1/8"	31135611	10
1/4"	1/4"	31135614	10
3/8"	1/4"	31136014	10
3/8"	3/8"	31136018	10



- body is orientable for positioning purposes

Extended Male Elbows

Tube OD	Male NPT	Nylon / Nickel Plated Brass Part #	Optional Qty
1/4"	1/8"	31295611	10
1/4"	1/4"	31295614	10
3/8"	1/4"	31296014	10
3/8"	3/8"	31296018	10



- body is orientable for positioning purposes

## Nylon/Nickel-Plated Brass Legris Push-In Fittings

## Male Branch Tees



Tube OD	Male NPT	Nylon / Nickel-Plated Brass Part #	Optional Qty
1/8"	10-32 <sup>1</sup>	<b>31085320</b>	10
1/8"	1/8"	<b>31085311</b>	10
5/32"	10-32 <sup>1</sup>	<b>31080420</b>	10
5/32"	1/8"	<b>31080411</b>	10
5/32"	1/4"	<b>31080414</b>	10
1/4"	1/8"	<b>31085611</b>	10
1/4"	1/4"	<b>31085614</b>	10
1/4"	3/8"	<b>31085618</b>	10
5/16"	1/8"	<b>31080811</b>	10
5/16"	1/4"	<b>31080814</b>	10
5/16"	3/8"	<b>31080818</b>	10
3/8"	1/8"	<b>31086011</b>	10
3/8"	1/4"	<b>31086014</b>	10
3/8"	3/8"	<b>31086018</b>	10
3/8"	1/2"	<b>31086022</b>	10
1/2"	1/4"	<b>31086214</b>	10
1/2"	3/8"	<b>31086218</b>	10
1/2"	1/2"	<b>31086222</b>	10

- <sup>1</sup> UNF - Straight thread, supplied with gasket  
 • body is orientable for positioning purposes

## Male Run Tees



Tube OD	Male NPT	Nylon / Nickel-Plated Brass Part #	Optional Qty
1/8"	10-32 <sup>1</sup>	<b>31035320</b>	10
1/8"	1/16"	<b>31035308</b>	10
1/8"	1/8"	<b>31035311</b>	10
5/32"	10-32 <sup>1</sup>	<b>31030420</b>	10
5/32"	1/8"	<b>31030411</b>	10
5/32"	1/4"	<b>31030414</b>	10
1/4"	1/8"	<b>31035611</b>	10
1/4"	1/4"	<b>31035614</b>	10
1/4"	3/8"	<b>31035618</b>	10
5/16"	1/8"	<b>31030811</b>	10
5/16"	1/4"	<b>31030814</b>	10
3/8"	1/8"	<b>31036011</b>	10
3/8"	1/4"	<b>31036014</b>	10
3/8"	3/8"	<b>31036018</b>	10
1/2"	1/4"	<b>31036214</b>	10
1/2"	3/8"	<b>31036218</b>	10
1/2"	1/2"	<b>31036222</b>	10

- <sup>1</sup> UNF - Straight thread, supplied with gasket  
 • body is orientable for positioning purposes

## Push-In Male Wyes



Tube OD	Male NPT	Nylon / Nickel Plated Brass Part #	Optional Qty
5/32"	1/8"	<b>31480411</b>	10
5/32"	1/4"	<b>31480414</b>	10
1/4"	1/8"	<b>31485611</b>	10
1/4"	1/4"	<b>31485614</b>	10

- body is orientable for positioning purposes

Nylon Legris Push-In Fittings

Unions

Tube OD	Nylon Part #	Optional Qty
1/8"	31065300	10
5/32"	31060400	10
1/4"	31065600	10
5/16"	31060800	10
3/8"	31066000	10
1/2"	31066200	10



Bulkhead Unions

Tube OD	Nylon Part #	Optional Qty
1/8"	31165300	10
5/32"	31160400	10
1/4"	31165600	10
5/16"	31160800	10
3/8"	31166000	10
1/2"	31166200	10



Union Elbows

Tube OD	Nylon Part #	Optional Qty
1/8"	31025300	10
5/32"	31020400	10
1/4"	31025600	10
5/16"	31020800	10
3/8"	31026000	10
1/2"	31026200	10



Plugs

Tube OD	Plastic Part #	Optional Qty
1/8"	31265300	10
5/32"	31260400	10
1/4"	31265600	10
5/16"	31260800	10
3/8"	31266000	10
1/2"	31266200	10



Union Tees

Tube OD	Nylon Part #	Optional Qty
1/8"	31045300	10
5/32"	31040400	10
1/4"	31045600	10
5/16"	31040800	10
3/8"	31046000	10
1/2"	31046200	10



Tube Wyes

Tube OD	Nylon Part #	Optional Qty
1/8"	31405300	10
5/32"	31400400	10
1/4"	31405600	10
5/16"	31400800	10
3/8"	31406000	10



## Nylon / Nickel-Plated Brass Legris Push-In Fitting Kit

**Features:**

- kit includes plastic case with threaded connectors, threaded elbows and several tube to tube connector configurations found on pages 350 to 353
- a tubing cutter is also included



Part #

**TFK**

**Kit contains the following parts:**

Part #	Qty	Description
31755311	10	tube to male NPT connector
31750411	10	tube to male NPT connector
31755611	10	tube to male NPT connector
31755614	10	tube to male NPT connector
31756014	5	tube to male NPT connector
31756018	5	tube to male NPT connector
31090411	10	tube to male NPT elbow
31095611	10	tube to male NPT elbow
31095614	10	tube to male NPT elbow
31096011	5	tube to male NPT elbow
31096014	5	tube to male NPT elbow
31096018	5	tube to male NPT elbow
31060400	10	tube to tube union
31065600	10	tube to tube union
31066000	5	tube to tube union
31400400	10	Y connector
31405600	10	Y connector
31406000	5	Y connector
31040400	10	tube to tube union tee
31045600	5	tube to tube union tee
31046000	5	tube to tube union tee
30007100	1	tubing cutter

## Legris Modular Manifolds



**Feature:**

- manifold with push to connect ports

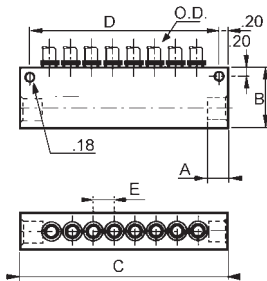

OD	NPT Size	Number of Outlets	Dimensions					Part #
			A	B	C	D	E	
1/4"	1/4"	8	.55	1.30	4.92	4.53	.50	<b>33155614</b>

## Legris Composite Mini Ball Valves

**Application:**

- valves enable in-line opening and closing of a pneumatic circuit

**Features:**

- 2-way, non-venting valve
- compact and lightweight, suited to all types of installation
- suitable fluid: compressed air
- maximum operating pressure: **145 PSI**
- vacuum rating: vacuum of 28" Hg (99% of vacuum)
- temperature range: **-4°F to 175°F (-20°C to 79°C)**
- nylon body with nickel-plated brass ball
- a screwdriver slot allows opening and closing even when access is difficult
- handle is differentiated by a blue color and marked with the corresponding pneumatic symbol enabling immediate identification by the user



Size	Part #
5/32"	<b>79100400</b>
1/4"	<b>79105600</b>
5/16"	<b>79100800</b>
3/8"	<b>79106000</b>

## Legris Quick Exhaust Valves

**Application:**

- can be used with all pneumatic equipment

**Features:**

- increases system efficiency and the speed of a cylinder by purging cylinder air at the cylinder port rather than the control valve
- pressure range: **10 PSI to 150 PSI**
- temperature range: **0°F to 160°F (-17°C to 71°C)**
- body: nickel-plated brass
- piston: polyurethane
- seals: nylon



NPT Thread	Part #
1/8"	<b>79821111</b>
1/4"	<b>79821414</b>
3/8"	<b>79821818</b>
1/2"	<b>79822222</b>

## Legris Compact Flow Control Valves

**Features:**

- Valves control the speed of a cylinder by regulating air exhaust. Intake air flows freely through the flow control and exhaust air is metered out through a specially designed fine adjustment screw.
- push-to connect, meter out flow control, one-piece design
- body: nylon
- control pressure range: **15 PSI to 145 PSI**
- temperature range: **32°F to 158°F (0°C to 70°C)**



Tube OD	NPT Size	Part #	Pkg Qty
5/32"	1/8"	<b>70650411</b>	10
1/4"	1/8"	<b>70655611</b>	10
1/4"	1/4"	<b>70655614</b>	10
3/8"	1/4"	<b>70656014</b>	10
3/8"	3/8"	<b>70656018</b>	10

## Legris Flow Control Valves

## Miniature Exhaust

## Features:

- Valves control the speed of a cylinder by regulating air exhaust. Intake air flows freely through the flow control and exhaust air is metered out through a specially designed fine adjustment screw.
- push-to connect, meter out flow control, one-piece design.
- body: nylon
- control pressure range: **15 PSI to 145 PSI**
- temperature range: **30°F to 158°F (-1°C to 70°C)**



Tube OD	NPT Size	Part #	Pkg Qty
5/32"	10-32 <sup>1</sup>	<b>76600420</b>	10
5/32"	1/8"	<b>76650411</b>	10
1/4"	10-32 <sup>1</sup>	<b>76605620</b>	10
1/4"	1/8"	<b>76655611</b>	10
1/4"	1/4"	<b>76655614</b>	10

<sup>1</sup> UNF - Straight thread, supplied with gasket

## In-Line

## Application:

- used where cylinder access is difficult or another fitting is attached to the cylinder port

## Features:

- working fluid: compressed air
- pressure range: **15 PSI to 145 PSI**
- temperature range: **32°F to 158°F (0°C to 70°C)**
- stackable using the 2 joining clips supplied or panel mountable using existing holes
- body: nylon
- gripping ring: stainless steel
- adjustment screw: nickel-plated brass
- locking nut: nickel-plated brass



Tube OD	Part #	Pkg Qty
5/32"	<b>77700400</b>	10
1/4"	<b>77705600</b>	10
3/8"	<b>77706000</b>	10
1/2"	<b>77706200</b>	10

## Threaded In-Line

## Features:

- intake air flows freely through the flow control; exhaust air is metered out through an adjustment screw
- arrow on the body of the valve indicates the direction of controlled flow
- may be installed as meter in or meter out devices
- unidirectional flow control valves
- working fluid: compressed air
- pressure range: **15 PSI to 145 PSI**
- temperature range: **32°F to 158°F (0°C to 70°C)**
- body: nylon with nickel plated brass thread
- adjustment screw: nickel-plated brass
- locking nut: nickel-plated brass
- threads: nickel-plated brass



Female NPT	Part #
1/8"	<b>77751111</b>
1/4"	<b>77751414</b>
3/8"	<b>77751818</b>
1/2"	<b>77752222</b>

## Legris Check Valves

### Non-Return In-Line

**Features:**

- allows air to pass in one direction while blocking flow in the other direction, a pressure of more than 7 PSI will overcome the spring pressure and allow flow
- arrow indicates free flow direction
- body: nylon/nickel plated brass
- maximum operating pressure: **145 PSI** at ambient temperature **70°F (21°C)**



Tube OD	Part #	Pkg Qty
5/32"	<b>79960400</b>	10
6mm	<b>79960600</b>	10
1/4"	<b>79965600</b>	10
5/16"	<b>79960800</b>	10

### In-Line

**Application:**

- suitable as a safety item in compressed air circuits

**Features:**

- compact, lightweight design meter out check valves
- allows air to pass in one direction while blocking flow in the other direction
- arrow on body of the fitting indicates direction of flow, a pressure of more than 7 PSI will overcome spring pressure keeping the valve closed, thus allowing the passage of air
- pressure range: **15 PSI** to **145 PSI** at ambient temperature **70°F (21°C)**
- body: nylon with nickel plated brass base
- pre-applied thread sealant on tapered threads



Tube OD	NPT Size	Part #
5/32"	10-32 <sup>1</sup>	<b>79940420</b>
5/32"	1/8"	<b>79950411</b>
1/4"	1/8"	<b>79955611</b>
1/4"	1/4"	<b>79955614</b>
3/8"	1/4"	<b>79956014</b>
3/8"	3/8"	<b>79956018</b>

<sup>1</sup> UNF - Straight thread, supplied with gasket

### Uni-Directional

**Features:**

- blocks the fluid passage when the pressure differential is lower than 3.6 PSI
- pressure range: **7 PSI** to **580 PSI**
- temperature range: **-4°F** to **356°F (-20° to 180°C)**
- body: 316L stainless steel
- shut-off valve: 316L stainless steel
- return spring: 302 stainless steel
- seals: FKM



NPT Thread	Part #
1/8"	<b>48951111</b>
1/4"	<b>48951414</b>
3/8"	<b>48951818</b>
1/2"	<b>48952222</b>

Legris Metric Push-In Fittings

Pneumatic Fittings

Features:

- materials: nickel-plated brass, black glass-filled nylon body, Buna-N D-seal, polypropylene release button, silicone free and nylon nickel plated brass or nylon
- positive seal: sealing and holding is accomplished instantaneously
- reusable: connect and disconnect numerous times
- full flow: fitting seals on outside diameter of tubing
- pressure rating: **290 PSI** at ambient temperature
- temperature range: **-4°F to 175°F (-20°C to 79°C)**
- pre-applied thread sealant on all tapered male pipe threads
- compatible tubing: semi-rigid nylon, polyurethane and polyethylene tube
- vacuum rating: vacuum of 28" Hg (99% vacuum)

Gripping Ring Technology



Quick Connect and Disconnect:

- to connect: simply push tubing in
- to disconnect: press the release ring towards the fitting and pull tubing out
- no tools required

Male BSPT Connectors



Tube OD	Male BSPT	Nickel Plated Brass Part #	Pkg Qty
4 mm	1/8"	<b>31750410</b>	10
4 mm	1/4"	<b>31750413</b>	10
6 mm	1/8"	<b>31750610</b>	10
6 mm	1/4"	<b>31750613</b>	10
8 mm	1/8"	<b>31750810</b>	10
8 mm	1/4"	<b>31750813</b>	10
8 mm	3/8"	<b>31750817</b>	10
10 mm	1/4"	<b>31751013</b>	10
10 mm	3/8"	<b>31751017</b>	10

- internal hex allows ease of assembly in tight places

Female BSPP Connectors

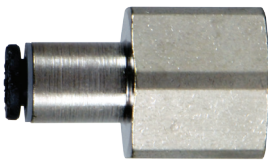

Tube OD	Female BSPP	Nickel Plated Brass Part #	Pkg Qty
4 mm	1/8"	<b>31140410</b>	10
4 mm	1/4"	<b>31140413</b>	10
6 mm	1/8"	<b>31140610</b>	10
6 mm	1/4"	<b>31140613</b>	10
8 mm	1/8"	<b>31140810</b>	10
8 mm	1/4"	<b>31140813</b>	10

Male BSPT Elbows



Tube OD	Male BSPT	Nylon / Nickel Plated Brass Part #	Pkg Qty
4 mm	1/8"	<b>31090410</b>	10
4 mm	1/4"	<b>31090413</b>	10
6 mm	1/8"	<b>31090610</b>	10
6 mm	1/4"	<b>31090613</b>	10
8 mm	1/8"	<b>31090810</b>	10
8 mm	1/4"	<b>31090813</b>	10
8 mm	3/8"	<b>31090817</b>	10
10 mm	1/4"	<b>31091013</b>	10
10 mm	3/8"	<b>31091017</b>	10

- body is orientable for positioning purposes



Legris Metric Push-In Fittings

Male Branch Tees

Tube OD	Male BSPT	Nylon / Nickel Plated Brass Part #	Pkg Qty
4 mm	1/8"	<b>31080410</b>	10
4 mm	1/4"	<b>31080413</b>	10
6 mm	1/8"	<b>31080610</b>	10
6 mm	1/4"	<b>31080613</b>	10
8 mm	1/8"	<b>31080810</b>	10
8 mm	1/4"	<b>31080813</b>	10



- body is orientable for positioning purposes

Nylon Tubing

Features:

- translucent color
- resistant to fungus, abrasion, moisture and UV
- temperature range: **-60°F to 200°F (-51°C to 93°C)**

Size		Wall Thickness	Working Pressure @ 75°F (24°C)	Length	Part #
OD	ID				
4 mm	2.7 mm	.65 mm	<b>350</b>	25 m	<b>1025P0400</b>
6 mm	4 mm	1 mm	<b>340</b>	25 m	<b>1025P0600</b>
8 mm	6 mm	1 mm	<b>250</b>	25 m	<b>1025P0800</b>



Tubing cutters sold on page 892

Male Threaded Connectors

Feature:

- internal hex allows ease of assembly in tight places

Tube OD	Male Thread	Nickel Plated Brass Part #	Pkg Qty
4 mm	M5	<b>31010419</b>	10
4 mm	1/8 BSPP	<b>31010410</b>	10
6 mm	M5	<b>31010619</b>	10
6 mm	1/8 BSPP	<b>31010610</b>	10
6 mm	1/4 BSPP	<b>31010613</b>	10
8 mm	1/8 BSPP	<b>31010810</b>	10
8 mm	1/4 BSPP	<b>31010813</b>	10
10 mm	1/4 BSPP	<b>31011013</b>	10



Bulkhead Union

Tube OD	Tube OD	Nylon Part #	Pkg Qty
6 mm	6 mm	<b>31160600</b>	10



Unions

Tube OD	Tube OD	Nylon Part #	Pkg Qty
4 mm	6 mm	<b>31060406</b>	10
6 mm	6 mm	<b>31060600</b>	10
10 mm	10 mm	<b>31061000</b>	10



## Legris Metric Push-In Fittings

## Male Elbows



Tube OD	Male Thread	Nylon / Nickel Plated Brass Part #	Pkg Qty
4 mm	M5	<b>31990419</b>	10
4 mm	1/8 BSPP	<b>31990410</b>	10
6 mm	M5	<b>31990619</b>	10
6 mm	1/8 BSPP	<b>31990610</b>	10
6 mm	1/4 BSPP	<b>31990613</b>	10
8 mm	1/8 BSPP	<b>31990810</b>	10
8 mm	1/4 BSPP	<b>31990813</b>	10
10 mm	1/4 BSPP	<b>31991013</b>	10

- body is orientable for positioning purposes

## Union Elbows



Tube OD	Tube OD	Nylon Part #	Pkg Qty
6 mm	6 mm	<b>31020600</b>	10
10 mm	10 mm	<b>31021000</b>	10

## Union Tees



Tube OD	Nylon Part #	Pkg Qty
6 mm	<b>31040600</b>	10
10 mm	<b>31041000</b>	10

## Y Connector



Tube OD	Tube OD	Nylon Part #	Pkg Qty
6 mm	6 mm	<b>31400600</b>	10

## Plugs



Tube OD	Tube OD	Plastic Part #	Pkg Qty
6 mm	6 mm	<b>31260600</b>	10
10 mm	10 mm	<b>31261000</b>	10

<b>Safety Cables</b> .....	362 to 364	<b>FRL's (cont.)</b> ...	368 to 370, 377 to 434
King Cable™ .....	362	Regulators.....	429, 430
Nylon King Cable™ .....	363	Lubricators .....	431
King™ safety whipsocs.....	364	Combination units .....	432
King™ safety shackles .....	364	Accessories and repair kits .....	433 to 434
ASME air receiver manifold with King™ safety whipsock .....	364		
<b>Air Tanks and Manifolds</b> .....	365 to 367	<b>Gauges</b> .....	435 to 444
ASME air receiver manifolds .....	365 to 366	Dry .....	435 to 438
Manifolds .....	366 to 367	Process.....	437
Compressor Y.....	367	Panel builder.....	439
Lubricants.....	367	Contractor pressure.....	439
		Compound.....	440
		Vacuum.....	440
		Liquid filled.....	441 to 443
		Welding.....	443
		Digital.....	444
		180° steam gauge siphon.....	444
<b>Blow guns</b> .....	371 to 375		
Safety .....	371 to 372	<b>Thermometers</b> .....	445 to 446
Non-Safety.....	373	Bi-metal .....	445 to 446
Heavy duty.....	374	Magnetic surface mount .....	446
High volume.....	375	Threaded thermowell.....	446
<b>Tire pressure gauges</b> .....	376	<b>Swivel Fittings</b> .....	447
		Ball .....	447
<b>FRL's</b> .....	368 to 370, 377 to 434	Push-on.....	447
In-line lubricators .....	368 to 369	In-line .....	447
In-line filters .....	368, 369, 370	Air tool swivel.....	447
Non-repairable general purpose regulator.....	370		
Wilkerson .....	377 to 405	<b>Mufflers and Vents</b> .....	448
Miniatures .....	377 to 380	Breather Vents .....	448
Filters .....	381 to 385	Conical muffler .....	448
Manual in-line desiccant dryer .....	386	Speed control muffler.....	448
Regulators.....	386 to 92		
Filter / regulator.....	391 to 392		
Lubricators .....	392 to 395		
Combination units .....	395 to 399		
Exhaust mufflers .....	399		
Automatic drains .....	400		
Lockout valves .....	400		
Accessories and repair kits .....	401 to 405		
Display .....	405		
Series 1 .....	406 to 427		
Display .....	406		
Miniatures .....	406 to 408		
Filters .....	409 to 411		
Regulators.....	412 to 416		
Filter / regulators.....	415 to 416		
Lubricators .....	417 to 420		
Combination units .....	421		
Accessories and repair kits .....	422 to 427		
Watts .....	428 to 434		
Filters .....	428		
Filter / regulators.....	429		

## **⚠ WARNING**

The constant vibration created by air tools, like air drills and pavement breakers, is destructive to air hose couplings, especially the quick-acting type. To provide protection against coupling breakage and related hazards, Dixon® recommends the use of a whip hose. To construct a whip hose, connect one end of a short (3' to 10') air hose to the air tool using a 3500 type steel nipple. Connect the other end of the hose to the air supply using the standard quick-acting coupling. The heat-treated 3500 nipple will withstand vibration far better than the standard coupling and provide a safer connection. The whip hose should remain permanently connected to the tool.

King Cable™

Features:

- must be installed in the extended position (no slack)
- cable reaches across hose fittings to provide standby safety for hose
- spring-loaded loops in the cable ends open easily to pass over the couplings for a firm grip on the hose
- no tools needed - easy to install and remove
- cables shipped with safety restraint labels attached
- highly resistant to rust and corrosion
- hose-to-hose or hose-to-rigid outlet
- maximum operating pressure: **200 PSI**
- minimizes damage to equipment and injuries to operators in the event hose, couplings or clamps fail, or there is an accidental separation of the assembly



Materials:

- For WB1, WB3, WA2, WA4, WSR1, WSR3, WSR2, WSR4, WSR1C, WB1C, WSR1E:
  - wire rope: galvanized carbon steel
  - ferrules: aluminum
  - springs: galvanized carbon steel
- For WB1SS, WA2SS, WSR1SS, WSR2SS:
  - wire rope: 304 stainless steel
  - ferrules: copper
  - springs: 304 stainless steel
- For WA2B:
  - wire rope: galvanized carbon steel
  - ferrules: copper
  - springs: galvanized carbon steel

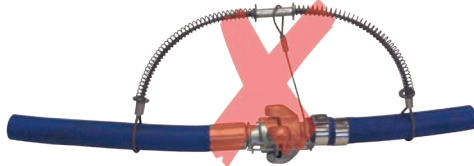

incorrect installation



correct installation

Hose-to-Tool Service



hose end

tool end

Hose ID	Cable	Length	Maximum Working Pressure (PSI)	Steel Part #	Stainless Steel Part #
1/2" - 1 1/4"	1/8"	20 1/4"	200	<b>WSR1</b>	<b>WSR1SS</b>
1/2" - 2"	3/16"	28"	200	<b>WSR3</b>	---
1 1/2" - 3"	1/4"	38"	200	<b>WSR2</b>	<b>WSR2SS</b>
4"	3/8"	44"	200	<b>WSR4</b>	---

Hose-to-Hose Service



hose end

hose end

Hose ID	Cable	Length	Maximum Working Pressure (PSI)	Steel Part #	Stainless Steel Part #
1/2" - 1 1/4"	1/8"	20 1/4"	200	<b>WB1</b>	<b>WB1SS</b>
1/2" - 2"	3/16"	28"	200	<b>WB3</b>	---
1 1/2" - 3"	1/4"	38"	200	<b>WA2</b>	<b>WA2SS</b>
4"	3/8"	44"	200	<b>WA4</b>	---

King Cable™ Options



WB1C - WB1 with safety clip and lanyard



WSR1E - WSR1E with stainless steel marine eye

Hose ID	Cable	Part #	Description	Max. Work. Press. PSI
1/2" - 1 1/4"	1/8"	<b>WSR1C</b>	WSR1 with safety clip and lanyard used to lock Air King™ couplings	200
1/2" - 1 1/4"	1/8"	<b>WB1C</b>	WB1 with safety clip and lanyard used to lock Air King™ couplings	200
1/2" - 1 1/4"	1/8"	<b>WSR1E</b>	WSR1 with stainless steel safety marine eye used to connect safety cable to a bolt on tool	200
1 1/2" - 3"	1/4"	<b>WA2B</b>	WA2 with bronze/copper ferrule for special environmental conditions	200

## Nylon King Cable™

**Applications:**

- pneumatic, hydraulic and water hoses

**Features:**

- strong, flexible nylon webbing
- superior corrosion and spark resistance over metal restraints
- rubber grommets securely choke eyes around hose
- must be installed in the extended position (no slack)
- shipped with labels detailing working pressures and safety instructions
- maximum working temperature: **200°F (93°C)**
- minimizes damage to equipment and injuries to operators in the event hose, couplings or clamps fail, or there is an accidental separation of the assembly
- contact Dixon at 888.226.4673 for additional options

**Materials:**

- strap: nylon
- grommets: rubber

Length	Recommended for use on the following hose inside diameters:								Nylon Part #
	¼"	½"	¾"	1"	2"	3"	4"	6"	
	Hose maximum working pressure (PSI) for above hose ID's								
30"	26,000	6,500	2,900	1,650	400	---	---	-	<b>WBN130</b>
40"	---	---	---	1,650	400	175	100	-	<b>WBN140</b>
30"	52,000	13,000	5,800	3,300	750	---	---	-	<b>WBN230</b>
64"	---	---	---	---	750	350	200	90	<b>WBN264</b>
44"	---	---	---	7,300	1,800	820	450	-	<b>WBN344</b>
64"	---	---	---	---	2,300	1,040	580	260	<b>WBN464</b>



Pneumatic Accessories

## King™ Safety Whipsocks

**Application:**

- ideally suited for applications where the media being transferred is under higher working pressures such as air, water, hydraulic and slurry

**Features:**

- King™ Safety Whipsocks keep the hose under control in the event of a high-pressure hose assembly failure.
- dual anchor points secured beyond the fittings eliminate hose whip
- be sure the anchoring points are rated for the application
- galvanized steel woven stockings extend down the hose to grip securely over a larger area preventing whip, abrasion and wear
- securing both eye-to-rigid or eye-to-eye anchor points reduce whip in the event of a hose connection failure
- contact Dixon® with questions regarding working pressure, available options or custom configurations

**Materials:**

- wire rope: galvanized carbon steel
- ferrules: aluminum

Size	OD Range	Length	Max. Working Pressure PSI	Part #
3/8"	.315" - .5512"	15.75"	<b>5000</b>	<b>KSW06</b>
1/2"	.5512" - .7874"	21.65"	<b>3000</b>	<b>KSW08</b>
3/4"	.7874" - 1.181"	25.20"	<b>2000</b>	<b>KSW12</b>
1"	1.181" - 1.575"	34.25"	<b>1500</b>	<b>KSW16</b>
1 1/4"	1.575" - 1.969"	38.19"	<b>1000</b>	<b>KSW20</b>
1 1/2"	1.969" - 2.362"	49.21"	<b>700</b>	<b>KSW24</b>
2"	2.362" - 2.756"	51.18"	<b>1300</b>	<b>KSW32</b>
2 1/2"	2.756" - 3.346"	53.15"	<b>800</b>	<b>KSW40</b>
3"	3.346" - 3.937"	72.44"	<b>750</b>	<b>KSW48</b>
3 1/2"	3.937" - 4.724"	72.05"	<b>550</b>	<b>KSW56</b>
4"	4.724" - 5.512"	86.61"	<b>550</b>	<b>KSW64</b>
6"	5.512" - 7.087"	93.31"	<b>250</b>	<b>KSW96</b>



KSW32



KSW40

## King™ Safety Shackles

**Applications:**

- 2 shackles are used to anchor the King™ Safety Whipsock
- securing both eyes to a rigid anchor point to reduce whip in the event of a hose or connection failure

**Features:**

- recommended bolt, nut, and cotter pin style shackle
- caution working load must be rated for the application



Size	Working Load	Fits KSW Eye	Micro Alloy Steel Part #
5/16"	3/4 ton (1000 lbs)	KSW06-KSW12	<b>KSS04</b>
7/16"	1 1/2 ton (3000 lbs)	KSW16-KSW40	<b>KSS06</b>
5/8"	3 1/4 ton (6000 lbs)	KSW48-KSW96	<b>KSS08</b>

ASME Air Receiver Manifold  
with King™ Safety Whipsock for Supply Hose**Features:**

- built to ASME Code, National Board registered
- conforms to OSHA standards 1910.169 and 1926.306
- 7 gallon capacity
- painted supply orange
- all openings are female NPT thread
- working pressure: **200 PSI**
- includes **KSW32** 2" King™ Safety Whipsock for Air Supply Hose
- shackles included to attach King™ Safety Whipsock to frame



Qty	Part #
1	<b>1217AR-4AK-KSW</b>

## ASME Air Receiver Manifold

**Features:**

- built to ASME Code, National Board registered
- conforms to OSHA standards 1910.169 and 1926.306
- 7 gallon capacity
- painted safety orange
- all openings are female NPT thread
- working pressure: **200 PSI**

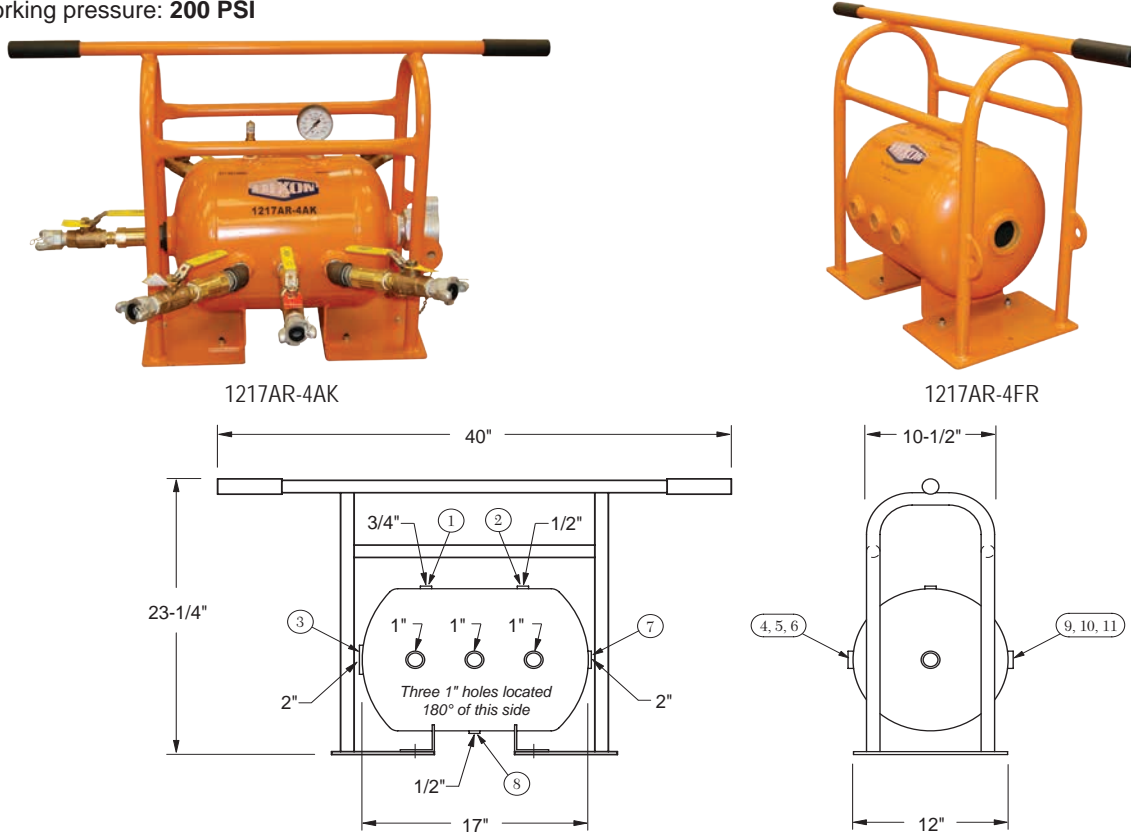

Dixon® 1217AR-4AK air receiver manifold assembly with Air King™ outlet ports includes the following components:

Part # / Locations	Qty	Description
<b>1217AR-4</b>	1	ASME compressed air receiver
<b>1217FRAME</b>	1	protective frame
Location 1	1	3731204C 3/4" male x 1/4" female hex bushing
Location 2	1	GL345 0-300 PSI gauge
Location 3	1	3730804C 1/2" male x 1/4" female hex bushing
Locations 4, 5, 6, 9, 10, 11	1	SV200 safety pop-off valve
	1	GM28 2" male spud
	1	B27SC wing nut cap
	6	HB1075G 1" male x 3/4" female bushings
	6	3701212C 3/4" brass hex nipples
	6	BBLV75 ball valves
	6	SCVS6 safety shut-off valves
Location 7	6	AM7 Air King™ universal couplings
	4	SE45100 45° street elbow (1 each in locations 4, 6, 9 and 11 only)
	1	HB2075 2" male x 3/4" female bushing
	1	3701212C 3/4" brass hex nipples
	1	BBLV75 ball valve
Location 8	1	SCVS6 safety shut-off valve
	1	AM7 Air King™ universal coupling
	1	3730804C 1/2" male x 1/4" female hex bushing
	1	D04 1/4" drain cock
	---	Labor cost for assembly of complete unit
<b>1217AR-4AK</b>	1	7 gallon ASME compressed air receiver manifold complete assembly with Air King™
		<b>Tank and Frame only</b>
<b>1217AR-4FR</b>	1	7 gallon ASME compressed air receiver with frame only

ASME Air Receiver Manifold Assembly with Air King™ Fittings & Watts Filter



**Application:**

- Designed to remove compressed air contaminants such as water, compressor oil, dirt, pipe scale and water particles from the air supply at the point of entry into the ASME air receiver manifold.

**Features:**

- includes basic 1217AR-4AK ASME manifold assembly
- F602-16WJR 2" auto drain filter with 26 ounce metal bowl and related plumbing installed on the inlet port of the ASME air receiver manifold
- air supply hose connects directly to GM28 2" male spud on the filter air inlet
- includes a B27SC wing nut cap with a chain

Hose Size	Thread	Part #
2"	3/4"	<b>1217AR-4AKWF</b>

Bar Manifolds



**Features:**

- can be mounted on a wall or work bench, safely distributing four hose lines to a work area
- maximum operating pressure: **300 PSI** at ambient temperature **70°F (21°C)**
- brass hex head plugs sold on page 367

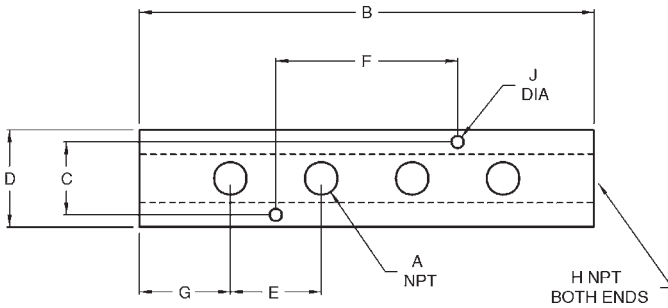

Aluminum Part #	A	B	C	D	E	F	G	H	J
<b>AMF32</b>	1/4"	7 5/8"	7/8"	1 1/4"	1 7/8"	3 3/4"	1"	3/8"	.20"
<b>AMF42</b>	1/4"	7 5/8"	1 1/8"	1 1/2"	1 7/8"	3 3/4"	1"	1/2"	.20"
<b>AMF43</b>	3/8"	8"	1 1/8"	1 1/2"	2"	4"	1"	1/2"	.20"

3 in 1 Manifolds

**Features:**

- supplies 3 air operated tools from a single hose permitting use of air by more than one mechanic
- can be mounted to a pipe at workbench or overhead
- different tools in the shop use different styles of couplers, mount 3 different style couplers on one manifold



NPT Inlet (1)	NPT Outlets (3)	Aluminum Part #
1/4"	1/4"	<b>D3404</b>
3/8"	1/4"	<b>D3406</b>
1/2"	1/4"	<b>D3408</b>



## Flat Hex Manifolds

**Feature:**

- designed to lay flat on the floor, safely distributing three hose lines to the work area

NPT Inlet (1)	NPT Outlets (3)	Brass Part #
1/4"	1/4"	<b>3122</b>
3/8"	1/4"	<b>3132</b>
3/8"	3/8"	<b>3133</b>

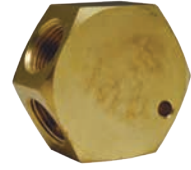

## Compressor Y

**Feature:**

- converts a single supply source to a dual outlet

Female NPT Inlet (1)	Male NPT Outlets (2)	Iron Part #
1"	3/4"	<b>Y10075</b>



## Anti-Freeze Lubricants

**Application:**

- winter grade air tool lubricant prevents air line, air tool and in-line lubricator freeze-up

**Features:**

- can be poured directly into tool or used with air line lubricators
- minimum temperature **-45°F (-43°C)**

Size	Part #	Optional Qty
1 pint	<b>DATL016W</b>	12
1 gallon	<b>DATL128W</b>	4



pint



gallon

## Air Tool Lubricants

**Application:**

- high grade lubricant prolongs the service life of air tools, cylinders and accessories

**Features:**

- #10 weight lubricant
- compound is superior in performance to ordinary lubricants
- prohibits rust and removes moisture as it lubricates
- non-corrosive, non-reactive and does not decompose
- easy pour spout helps prevent costly spills
- use with the in-line lubricators on page 368

Size	Part #	Optional Qty
1 pint	<b>DATL016</b>	12
1 gallon	<b>DATL128</b>	4



pint



gallon

## In-Line Lubricators

## Features:

- protects portable or stationary air tools by efficiently oiling the tool mechanisms; each time an air tool is operated a fine mist of oil is injected into it along with the air from the compressor
- installation is recommended within 25' of the tool to be lubricated, refer to the arrow for proper air flow direction
- transparent sight disc allows visual inspection of oil level
- oil flow regulated by screwdriver screw adjustment, minimum flow rate is 30 SCFM
- not recommended for constant flow applications
- for reciprocating tools only
- type of oil to use: any petroleum-based, non-detergent light weight oil (SAE 10/150SSU) which will readily break up into a mist, i.e., Mobil DTE light or comparable oil, do not use any synthetic oil or oils containing additives or solvents
- see page 367 for air tool lubricant



NPT Size	Oil Capacity	Maximum Working Pressure at ambient temperature (70°F)	Air Flow at 70 PSI	Aluminum Part #
½"	1.4 fluid ozs.	<b>500 PSI</b>	30 SCFM	<b>PL300</b>
¾"	3.7 fluid ozs.	<b>200 PSI</b>	70 SCFM	<b>PL400</b>
¾"	11.0 fluid ozs.	<b>300 PSI</b>	70 SCFM	<b>PL400L</b>
1"	16.0 fluid ozs.	<b>250 PSI</b>	100 SCFM	<b>PL500</b>

## Replacement Parts

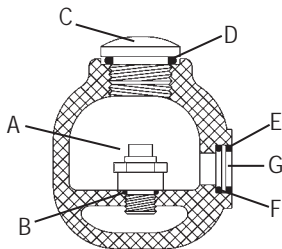

Description	Part #
(A) oil adjustment valve assembly	<b>851661</b>
(B) valve gasket	<b>452531</b>
(C) fill plug	<b>452525</b>
(D) fill plug O-ring	<b>700013-214</b>
(E) sight disk	<b>452532</b>
(F) sight disk seal	<b>700013-016</b>
(G) sight disk lock nut	<b>452533</b>

## In-Line Air Filter

## Features:

- protects small air tools, such as impact wrenches, nut runners, grinders and screwdrivers
- all-anodized, compact housing
- install directly before the air tool
- maximum operating pressure: **500 PSI**
- temperature range: **35°F to 200°F (2°C to 93°C)**
- air flow: 140 SCFM
- male x female configuration
- standard 40 micron element ensures minimum pressure drop
- elements can be replaced quickly



Male NPT	Overall Length	Diameter	Aluminum Part #
¾"	3-13/16"	1½"	<b>9076M</b>

## Disposable In-Line Nipple Filters

### Features:

- for filtration of water, oil and air
- compact and lightweight
- can be installed at point of use
- shape element is conical rather than disc, providing a larger filtering flow and a true, uninterrupted axial flow
- maximum operating pressure: **300 PSI**
- temperature range: **35°F to 300°F (2°C to 148°C)**
- standard 40 micron element ensures minimum pressure drop

Male NPT	Overall Length	Hex	Air Flow	Brass Part #
¼"	1½"	9/16"	20 SCFM	<b>ASP3102-40</b>
½"	2"	7/8"	50 SCFM	<b>ASP3104-40</b>



Pneumatic  
Accessories

## In-Line Lubricator with Filter

### Feature:

- consists of **9076M** particle filter with 40 micron sintered bronze element and **PL400** (3.7 ounce) or **PL400L** (11.0 ounce) lubricator

NPT Size	Oil Capacity	Max. Working Pressure at ambient temperature 70°F (21°C)	Aluminum Part #
¾"	3.7 fluid ozs.	<b>200 PSI</b>	<b>PL400WF</b>
¾"	11.0 fluid ozs.	<b>300 PSI</b>	<b>PL400LWF</b>



## Mini In-Line Lubricators

### Features:

- can be refilled under line pressure
- oil capacity: ¼ fluid ounce
- flow rating: 22 SCFM at 100 PSIG
- maximum operating pressure: **200 PSIG**
- maximum temperature: **150°F (66°C)**

Female NPT Inlet	Outlet	Aluminum Part #
¼"	¼" female NPT	<b>ML200</b>
¼"	¼" male NPT	<b>ML200M</b>
⅜"	⅜" male NPT	<b>ML300M</b>



## Mini In-Line Filter

**Features:**

- either port may be used as an inlet port
- filter element rated at 5 microns
- flow rating: 17 SCFM inlet pressure at 100 PSIG
- maximum operating pressure: **200 PSIG**  
maximum temperature: **175°F (79°C)**



Female NPT	Male NPT	Aluminum Part #
1/4"	1/4"	<b>MF200</b>

## Replacement Element



Description	Part #
with O-ring	<b>FRP-95-199</b>

## Series 1 Non-Repairable General Purpose Regulators

**Features:**

- relieving piston allows reduction of downstream pressure when system is dead-ended
- reliable pressure regulation at air flows up to 13 SCFM
- left to right flow
- 5 to 125 PSIG outlet pressure adjustment range
- compact design and light weight construction
- wrench flats for easy installation
- supplied with a GC620 gauge



Female NPT	With Gauge Part #	Without Gauge Part #
1/4"	<b>R46-200RG</b>	<b>R46-200R</b>

## Safety Blow Guns

Safety blow guns have a safety tip which prevents buildup of tip pressure in the event the outlet is obstructed or "dead ended". They comply with the requirements for OSHA 1910.242 (B) and 1910.95 when used on air lines of 150 PSI or less.

**Features:**

- design comfortably fits contour of the hand minimizing user fatigue
- ergonomic large lever with black vinyl grip allows for easy air flow activation
- ¼" female NPT inlet

---

**Air Chief**

The air chief safety blow gun is designed to conform to OSHA Standard 1910.242 (B) permitting a maximum of 30 PSI outlet pressure when dead ended based on a maximum of 150 PSI inlet pressure as well as OSHA Standard 1910.95 regulating occupational noise level exposure. *Safety glasses or shield must be worn when using any blow gun.*

**Features:**

- recessed internal slotted screw allows easy access to valve assembly for repairs or replacement
- chrome plated zinc die cast body, nickel plated steel lever, vinyl thumb grip, stainless steel spring, brass valve, Buna-N seals and nickel plated brass tip combine for superior corrosion resistance



---

 Part #

---

**D204-30**

---



---

**Premium**

The premium safety blow gun is designed to conform to OSHA Standard 1910.242 (B) permitting a maximum of 30 PSI outlet pressure when dead ended based on a maximum of 150 PSI inlet pressure as well as OSHA Standard 1910.95 regulating occupational noise level exposure. *Safety glasses or shield must be worn when using any blow gun.*

**Feature:**

- zinc die cast body with a black powder coat finish, nickel plated steel lever, vinyl thumb grip, stainless steel spring, brass valve, Buna-N seals and nickel plated brass tip



---

 Part #

---

**D204-30P**

---



---

**Air Booster**

The multiple holes in the safety booster tip of the safety air booster gun create a Venturi effect that increases air flow (working capacity) while still remaining compliant with OSHA Standard 1910.242 (B). *Safety glasses or shield must be worn when using any blow gun.*

**Feature:**

- chrome plated zinc die cast body, nickel plated steel lever, vinyl thumb grip, stainless steel spring, brass valve, Buna-N seals and nickel plated brass tip provide superior corrosion resistance



---

 Part #

---

**D204-30SB**

---



## Pistol Grip

### Features:

- conforms to US Department of Labor, OSHA Standard 1910.242 (B) allowing a maximum of 30 PSI outlet pressure at the nozzle when dead-ended
- conforms to US Department of Labor, OSHA Standard 1910.95 regulating noise level exposure
- contoured pistol-grip for safe, comfortable handling, even with greasy hands
- convenient hang-up hook
- ¼" female NPT inlet
- *Safety glasses or shield must be worn when using any blow gun.*



---

 Part #

---

**PG700**

## Extended Nozzle Pistol Grip



### Features:

- conforms to US Dept. of Labor, OSHA Standard 1910.242 (B) allowing a maximum of 30 PSI outlet pressure at the nozzle when dead-ended
- conforms to US Dept. of Labor, OSHA Standard 1910.95 regulating noise level exposure
- slender 4" extended nozzle allows access to hard to reach places and holes as small as .200"
- variable output trigger enables user to control air flow
- hook design near trigger provides finger protection as well as easy storage
- lightweight to help minimize user fatigue.
- side holes allow air to escape if nozzle tip is dead-ended, thus preventing back pressure buildup
- pressure rating: **150 PSI**
- ¼" female NPT inlet
- *Safety glasses or shield must be worn when using any blow gun.*



---

 Part #

---

**ENBG1**

## Safety Tip

### Features:

- ⅛" male NPT connection
- can be used with all Dixon® Air Chief lever operated blow guns as well as most blow guns from other manufacturers

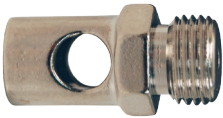

---

*Nickel Plated Brass*

Part #

---

**SST10**

## Rubber Non-Safety Tip

### Features:

- ⅛" male NPT connection
- can be used with all Dixon® Air Chief lever operated blow guns as well as most blow guns from other manufacturers



---

*Rubber Coated Nickel Plated Brass*

Part #

---

**D201RT**

## Non-Safety Blow Gun

Non-Safety blow guns **do not** have a safety by-pass to prevent buildup of tip pressure in the event of tip blockage. They may be used for cleaning purposes only if the air supply (inlet pressure) has been reduced to 30 PSI or less.



**Features:**

- designed to comfortably fit the contour of the hand, minimizing user fatigue
- ergonomic large lever with vinyl grip allows for easy air flow activation
- ¼" female NPT inlet

### Brass Tip

The ventless, nickel-plated tip provides the most economical means of achieving a concentrated stream of air for many blow-off applications. All other components and design features are the same as our Air Chief safety blow gun (D204-30). *Must be used on air lines having a maximum regulated pressure of 30 PSI in order to comply with OSHA Standard 1910.242 (B). Safety glasses or shield must be worn when using any blow gun.*



**Feature:**

- chrome plated zinc die cast body, nickel plated steel lever, vinyl thumb grip, stainless steel spring, brass valve, Buna-N seals and ventless, nickel plated brass tip provide superior corrosion resistance



Part #

**D605**

### Rubber Tip

The rubber tip will not scratch or mar delicate surfaces. The conical, rubber tip can also be used to create a seal between the blow gun and fluid lines (or any other opening). Base of the tip is nickel-plated brass for additional corrosion resistance. *Must be used on air lines having a maximum regulated pressure of 30 PSI in order to comply with OSHA Standard 1910.242 (B). Safety glasses or shield must be worn when using any blow gun.*



**Feature:**

- chrome plated zinc die cast body, nickel plated steel lever, vinyl thumb grip, stainless steel spring, brass valve, Buna-N seals and rubber tip with a nickel plated brass base provide superior corrosion resistance



Part #

**D201**

### Extensions

**Features:**

- supplied with ⅛" male NPT connections
- allow easier access to blow-off applications in high or hard to reach places
- can be used with all Dixon® Air Chief lever operated blow guns as well as most blow guns from other manufacturers
- brass base with a rugged steel extension tube, all nickel plated

Size Extension	Part #
6"	<b>BGE6</b>
10"	<b>BGE10</b>
12"	<b>BGE12</b>
18"	<b>BGE18</b>
24"	<b>BGE24</b>



Heavy Duty - **High Volume** Safety Blow Guns**Features:**

- heavy duty - high volume safety blow guns
- requires high volume coupler and plug for optimum performance
- lightweight and ergonomic
- pistol grip / hanging hook handle
- made from high quality aluminum casting
- maximum operating pressure: **150 PSI**
- ¼" female NPT inlet
- *Safety glasses or shield must be worn when using any blow gun.* 

Heavy Duty - **High Volume with** Safety Tip**Features:**

- reduced to 30 PSI when tip is blocked
- The safety air booster blow gun has a safety tip which prevents buildup of tip pressure in the event the outlet obstructed or "dead ended". It complies with the requirements for OSHA 1910.242 (B) and 1910.95 when used on air lines of 150 PSI or less. 



HTBG6

Description	Part #
gun with <i>no</i> extension	<b>HTBG</b>
gun with 6" extension	<b>HTBG6</b>
gun with 12" extension	<b>HTBG12</b>
gun with 24" extension	<b>HTBG24</b>
gun with 36" extension	<b>HTBG36</b>

Heavy Duty - **High Volume with Quiet Conical Tip****Feature:**

- 6.0 CFM

Description	Part #
gun with tip only	<b>HTBG-CT</b>

**Accessories**

HTBGC

Female NPT Inlet (1)	Aluminum Part #	Brass Part #
6" extension with safety tip	<b>HTBG6EXT</b>	---
12" extension with safety tip	<b>HTBG12EXT</b>	---
24" extension with safety tip	<b>HTBG24EXT</b>	---
36" extension with safety tip	<b>HTBG36EXT</b>	---
safety tip	<b>HTBGS</b>	---
conical tip	<b>HTBGC</b>	---
tip adapter	<b>HTBGA</b>	---
high flow female coupler	---	<b>2CJF2-B</b>
high flow male plug	---	<b>CJ2M2-B</b>



## High Volume Typhoon Blow Guns

**Features:**

- chrome plated aluminum body
- variable flow control
- ¼" female NPT inlet
- 34 CFM at 125 PSI
- Compliant with OSHA Standard 1910.242 (B). *Safety glasses or shield must be worn when using any blow gun.*



Pneumatic  
Accessories

Description	Part #
gun with no extension	<b>TYP2501</b>
gun with 6" extension	<b>TYP2501-6</b>
gun with 12" extension	<b>TYP2501-12</b>
gun with 24" extension	<b>TYP2501-24</b>
gun with 36" extension	<b>TYP2501-36</b>

## High Volume Cannon® Blow Gun

**Application:**

- designed for, but not limited to, outdoor use, ideal where a large air supply is available to move heavy, stubborn debris

**Features:**

- ¾" female NPT inlet
- minimum inlet pressure 90 PSI on ½" hose
- consumes 135 CFM at 100 PSI
- 48" long extension
- compliant with OSHA Standard 1910.242 (B)
- *Safety glasses or shield must be worn when using any blow gun.*



Part #
<b>9000-48S</b>





### Heavy Duty Tire Pressure Gauge

**Features:**

- 12" hose with swivel dual foot chuck inflator
- tapered chuck nut fits wheel cover holes on cars and light trucks
- calibrated in 2 PSI increments from **10 to 120 PSI**

Part #

**D101**

### Passenger Car Tire Pressure Gauge

**Features:**

- 12" hose with straight-on chuck
- straight chuck nut fits wheel cover holes on cars and light trucks
- ideal for use on wells and reels
- calibrated in 2 PSI increments from **10 to 90 PSI**



Part #

**D150**

### Professional Tire Pressure Gauge

**Features:**

- permanently lubricated
- easy to read, dual calibrated (PSI and kPa), four-sided nylon indicator bar
- body is made of chrome-plated brass, head is chrome-plated zinc
- pocket clip
- calibrated in 1 PSI increments from **5 to 45 PSI**



Part #

**DFG5**

### Dual Foot Tire Pressure Gauges

**Features:**

- handy pocket clip
- calibrated in 2 PSI increments from **20 to 120 PSI**



Part #

**DFG1**
**Features:**

- heavy duty hang-up ring
- calibrated in 2 PSI increments from **10 to 150 PSI**



Part #

**DFG2**

### Tire Inflator Chuck

**Features:**

- ball foot chuck
- for direct connection to live air only
- features a built-in shutoff valve (will not work on inflator gauges)
- ¼" NPT female thread
- maximum pressure is **150 PSI**

Brass  
Part #**D104**

Optional Qty

10

### F03 Miniature Filters

**Features:**

- excellent water removal efficiency
- 5 micron element
- .5 oz. bowl
- maximum operating conditions:
  - transparent bowl: **150 PSIG** (10.3 bar) and **32°F to 125°F (0°C to 52°C)**
  - metal bowl: **250 PSIG** (17.2 bar) and **32°F to 175°F (0°C to 80°C)**

Port Size	Flow (SCFM)	Transparent Bowl		Metal Bowl	
		Automatic Drain Part #	Manual Drain Part #	Automatic Drain Part #	Manual Drain Part #
1/8"	22	<b>F03-01A</b>	<b>F03-01M</b>	<b>F03-01AMB</b>	<b>F03-01MMB</b>
1/4"	24	<b>F03-02A</b>	<b>F03-02M</b>	<b>F03-02AMB</b>	<b>F03-02MMB</b>

SCFM ratings at 90 PSIG inlet pressure.

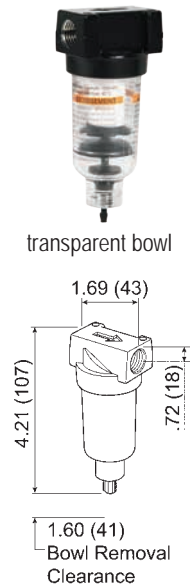

Pneumatic Accessories

### F08 Miniature Filters

**Features:**

- 5 micron element
- .6 oz. bowl
- maximum operating conditions:
  - transparent bowl: **150 PSIG** (10.3 bar) and **32°F to 125°F (0°C to 52°C)**
  - metal bowl: **250 PSIG** (17.2 bar) and **32°F to 150°F (0°C to 65.5°C)**

Port Size	Flow (SCFM)	Transparent Bowl and Guard		Metal Bowl	
		Automatic Drain Part #	Manual Drain Part #	Automatic Drain Part #	Manual Drain Part #
1/4"	50	<b>F08-02A</b>	<b>F08-02M</b>	<b>F08-02AMB</b>	<b>F08-02MMB</b>

See pages 401 to 405 for accessories.

SCFM ratings at 150 PSIG inlet pressure.

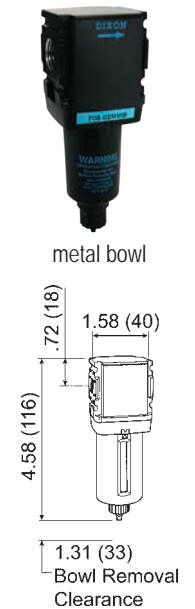

### R03 Miniature Regulators

**Features:**

- 2-125 PSI adjusting range
- balanced valve design
- self-relieving standard
- non-rising push/pull locking adjustment knob
- two 1/8" NPT gauge ports standard on models without gauge, one 1/8" NPT gauge port standard on models with gauge - can be used for additional outlet ports.
- models supplied without gauge use a GC620 gauge.
- panel mount nuts sold separately
- maximum operating conditions:
  - 300 PSIG** (20.17 bar) and **32°F to 125°F (0°C to 52°C)**

Size	Flow (SCFM)	With Gauge Part #	Without Gauge Part #
1/8"	13	<b>R03-01RG</b>	<b>R03-01R</b>
1/4"	15	<b>R03-02RG</b>	<b>R03-02R</b>

SCFM ratings at 100 PSIG inlet pressure.



See pages 401 to 405 for accessories.



FRL's are designed for air service only, unless otherwise indicated.

## R08 Miniature Regulators

**Features:**

- 0-125 PSI adjusting range
- balanced valve design
- self-relieving standard
- non-rising push/pull locking adjustment knob
- two 1/8" NPT gauge ports standard on models without gauge, one 1/8" NPT gauge port standard on models with gauge - can be used for additional outlet ports.
- models with gauge are supplied with a 0-160 flush mount style gauge
- models supplied without gauge use a GC620 gauge.
- panel mount nuts sold separately
- maximum operating conditions:  
**300 PSIG (20.7 bar) and 32°F to 150°F (0°C to 66°C)**

Size	Flow (SCFM)	With Gauge Part #	Without Gauge Part #
1/4"	44	<b>R08-02RG</b>	<b>R08-02R</b>

SCFM ratings at 100 PSIG inlet pressure.

## RB3 Miniature Water Regulators

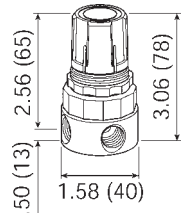
**Features:**

- 2-125 PSI adjusting range
- suitable for water and compressed air service
- brass construction - wetted parts
- non-relieving spring-loaded diaphragm
- panel mount nut included
- two 1/8" NPT gauge ports standard
- models supplied without gauge use a GC620 gauge
- maximum operating conditions:  
**300 PSIG (20.7 bar) and 40°F to 125°F (4°C to 52°C)**

Size	Flow (SCFM)	With Gauge Part #	Without Gauge Part #
1/8"	11	<b>RB3-01RG</b>	<b>RB3-01R</b>
1/4"	14	<b>RB3-02RG</b>	<b>RB3-02R</b>

SCFM ratings at 100 PSIG inlet pressure.

See pages 401 to 405 for accessories.

## BB3 Miniature Filters / Regulators

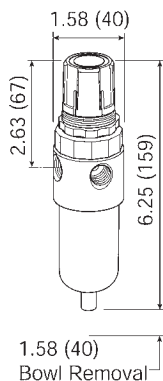

transparent bowl

1.58 (40)  
Bowl Removal**Features:**

- 2-125 PSI adjusting range
- 5 micron element
- .5 oz. bowl
- self-relieving
- supplied with a GC620 gauge
- maximum operating conditions:
  - transparent bowl: **125 PSIG (8.6 bar) and 40°F to 125°F (4.4°C to 52°C)**
  - metal bowl: **300 PSIG (20.7 bar) and 40°F to 125°F (4.4°C to 52°C)**

Port Size	Flow (SCFM)	Transparent Bowl		Metal Bowl	
		Automatic Drain Part #	Manual Drain Part #	Automatic Drain Part #	Manual Drain Part #
1/8"	13	<b>BB3-01AG</b>	<b>BB3-01MG</b>	<b>BB3-01AGMB</b>	<b>BB3-01MGMB</b>
1/4"	16	<b>BB3-02AG</b>	<b>BB3-02MG</b>	<b>BB3-02AGMB</b>	<b>BB3-02MGMB</b>

SCFM ratings at 150 PSIG inlet pressure.



FRL's are designed for air service only, unless otherwise indicated.

## B08 Miniature Filters / Regulators

**Features:**

- 0-125 PSI adjusting range
- 5 micron element
- .4 oz. bowl
- self-relieving
- supplied with a 0-160 PSI flush mount style gauge
- maximum operating conditions:
  - transparent bowl: **150 PSIG** (10.3 bar) and **32°F to 125°F (0°C to 52°C)**
  - metal bowl: **250 PSIG** (17.2 bar) and **32°F to 150°F (0°C to 65.5°C)**

Size	Flow (SCFM)	Transparent Bowl and Guard		Metal Bowl	
		Automatic Drain Part #	Manual Drain Part #	Automatic Drain Part #	Manual Drain Part #
1/4"	42	<b>B08-02AG</b>	<b>B08-02MG</b>	<b>B08-02AGMB</b>	<b>B08-02MGMB</b>

See pages 401 to 405 for accessories.  
SCFM ratings at 100 PSIG inlet pressure.

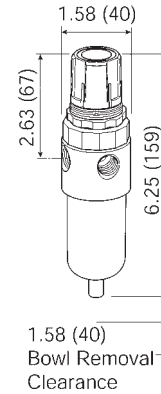

metal bowl

Pneumatic Accessories

## L03 Miniature Lubricators

**Features:**

- 1 oz. bowl
- adjustable oil feed
- full view sight dome
- **Do not fill under pressure. Air supply must be turned off and pressure bled from unit prior to adding oil.**
- maximum operating conditions:
  - transparent bowl: **150 PSIG** (10.3 bar) and **32°F to 125°F (0°C to 52°C)**
  - metal bowl: **250 PSIG** (17.2 bar) and **32°F to 175°F (0°C to 80°C)**

Size	Flow (SCFM)	Transparent Bowl Part #	Metal Bowl Part #
1/8"	20	<b>L03-01A</b>	<b>L03-01AMB</b>
1/4"	20	<b>L03-02A</b>	<b>L03-02AMB</b>

SCFM ratings at 90 PSIG inlet pressure.

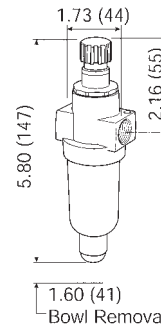

transparent bowl

## L08 Miniature Lubricators

**Features:**

- .6 oz. bowl
- adjustable oil feed
- full view sight dome
- fill under pressure design
- maximum operating conditions:
  - transparent bowl: **150 PSIG** (10.3 bar) and **32°F to 125°F (0°C to 52°C)**
  - metal bowl: **250 PSIG** (17.2 bar) and **32°F to 150°F (0°C to 65.5°C)**

Size	Flow (SCFM)	Transparent Bowl Part #	Metal Bowl Part #
1/4"	57.5	<b>L08-02A</b>	<b>L08-02AMB</b>

See pages 401 to 405 for accessories.  
See page 367 for air tool lubricant.

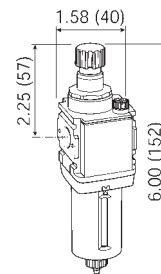

metal bowl

FRL's are designed for air service only, unless otherwise indicated.

SCFM ratings at 150 PSIG inlet pressure.



transparent bowl

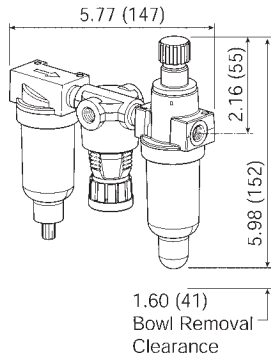

## C03 Miniature Combination Units

### Features:

- maximum operating conditions:
  - transparent bowl: **150 PSIG** (10.3 bar) and **32°F to 125°F (0°C to 52°C)**
  - metal bowl: **250 PSIG** (17.2 bar) and **32°F to 175°F (0°C to 80°C)**
- Included components: (2) adapters

### Filter series F03:

- 5 micron element
- .5 oz. bowl

### Regulator series R03:

- 2-125 PSI adjusting range
- balanced valve design
- self-relieving
- supplied with a GC620 gauge
- can be mounted with knob in up or down position

### Lubricator series L03:

- 1 oz. bowl
- adjustable oil feed
- full view sight dome

Size	Flow (SCFM)	Transparent Bowl and Guard		Metal Bowl	
		Automatic Drain Part #	Manual Drain Part #	Automatic Drain Part #	Manual Drain Part #
1/8"	20	<b>C03-01A</b>	<b>C03-01M</b>	<b>C03-01AMB</b>	<b>C03-01MMB</b>
1/4"	20	<b>C03-02A</b>	<b>C03-02M</b>	<b>C03-02AMB</b>	<b>C03-02MMB</b>

SCFM ratings at 100 PSIG inlet pressure.

## C08 Miniature Combination Units



metal bowl

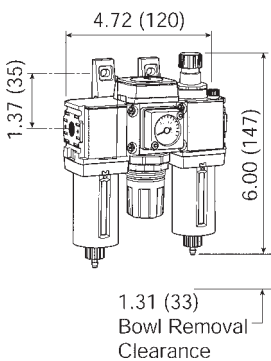

### Features:

- maximum operating conditions:
  - transparent bowl: **150 PSIG** (10.3 bar) and **32°F to 125°F (0°C to 52°C)**
  - metal bowl: **250 PSIG** (17.2 bar) and **32°F to 150°F (0°C to 65.5°C)**
- Included components: (2) mounting brackets with joiner set

### Filter series F08:

- 5 micron element
- .6 oz. bowl

### Regulator series R08:

- 0-125 PSI adjusting range
- balanced valve design
- self-relieving
- supplied with a 0-160 PSI flush mount style gauge

### Lubricator series L08:

- .6 oz. bowl
- adjustable oil feed
- full view sight dome

Size	Flow (SCFM)	Transparent Bowl and Guard		Metal Bowl	
		Automatic Drain Part #	Manual Drain Part #	Automatic Drain Part #	Manual Drain Part #
1/4"	44	<b>C08-02A</b>	<b>C08-02M</b>	<b>C08-02AMB</b>	<b>C08-02MMB</b>

**!** FRL's are designed for air service only, unless otherwise indicated.

SCFM ratings at 100 PSIG inlet pressure.

## F16 Compact Airline Filters

**Features:**

- 5 micron element
- 2.7 oz. bowl
- maximum operating conditions:
  - transparent bowl: **150 PSIG** (10.3 bar) and **32°F to 125°F (0°C to 52°C)**
  - metal bowl: **200 PSIG** (13.8 bar) and **32°F to 150°F (0°C to 65.5°C)**

Size	Flow (SCFM)	Transparent Bowl and Guard		Metal Bowl	
		Automatic Drain Part #	Manual Drain Part #	Automatic Drain Part #	Manual Drain Part #
¼"	63.0	<b>F16-02A</b>	<b>F16-02M</b>	<b>F16-02AMB</b>	<b>F16-02MMB</b>
⅜"	74.1	<b>F16-03A</b>	<b>F16-03M</b>	<b>F16-03AMB</b>	<b>F16-03MMB</b>
½"	80.4	<b>F16-04A</b>	<b>F16-04M</b>	<b>F16-04AMB</b>	<b>F16-04MMB</b>



with guard

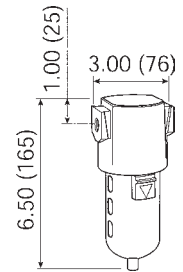

Pneumatic Accessories

## F18 Compact Airline Filters

**Features:**

- high flow capacity
- 5 micron element
- 1.72 oz. bowl
- maximum operating conditions:
  - transparent bowl: **150 PSIG** (10.3 bar) and **32°F to 125°F (0°C to 52°C)**
  - metal bowl: **250 PSIG** (17.2 bar) and **32°F to 150°F (0°C to 65.5°C)**

Size	Flow (SCFM)	Transparent Bowl and Guard		Metal Bowl with Sight Glass	
		Automatic Drain Part #	Manual Drain Part #	Automatic Drain Part #	Manual Drain Part #
¼"	110	<b>F18-02A</b>	<b>F18-02M</b>	<b>F18-02AMB</b>	<b>F18-02MMB</b>
⅜"	120	<b>F18-03A</b>	<b>F18-03M</b>	<b>F18-03AMB</b>	<b>F18-03MMB</b>
½"	145	<b>F18-04A</b>	<b>F18-04M</b>	<b>F18-04AMB</b>	<b>F18-04MMB</b>



transparent bowl with guard

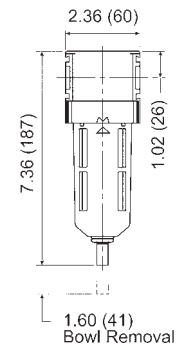

## F26 Standard Airline Filters

**Features:**

- 5 micron element
- 3.2 oz. bowl
- maximum operating conditions:
  - transparent bowl: **150 PSIG** (10.3 bar) and **32°F to 125°F (0°C to 52°C)**
  - metal bowl: **200 PSIG** (13.8 bar) and **32°F to 150°F (0°C to 65.5°C)**

Size	Flow (SCFM)	Transparent Bowl and Guard		Metal Bowl with Sight Glass	
		Automatic Drain Part #	Manual Drain Part #	Automatic Drain Part #	Manual Drain Part #
¼"	81.3	<b>F26-02A</b>	<b>F26-02M</b>	<b>F26-02AMB</b>	<b>F26-02MMB</b>
⅜"	117.8	<b>F26-03A</b>	<b>F26-03M</b>	<b>F26-03AMB</b>	<b>F26-03MMB</b>
½"	149.8	<b>F26-04A</b>	<b>F26-04M</b>	<b>F26-04AMB</b>	<b>F26-04MMB</b>



with guard

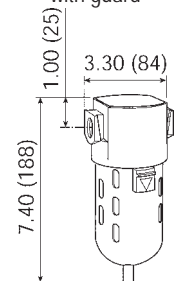

See pages 401 to 405 for accessories.

FRL's are designed for air service only, unless otherwise indicated.  
SCFM ratings at 150 PSIG inlet pressure.

## F28 Standard Airline Filters

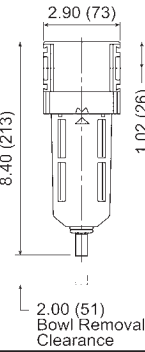

with metal bowl

**Features:**

- high flow capacity
- 5 micron element
- 2.87 oz. bowl
- maximum operating conditions:
  - transparent bowl: **150 PSIG** (10.3 bar) and **32°F to 125°F (0°C to 52°C)**
  - metal bowl: **250 PSIG** (17.2 bar) and **32°F to 150°F (0°C to 65.5°C)**

Size	Flow (SCFM)	Transparent Bowl and Guard		Metal Bowl with Sight Glass	
		Automatic Drain Part #	Manual Drain Part #	Automatic Drain Part #	Manual Drain Part #
3/8"	144	<b>F28-03A</b>	<b>F28-03M</b>	<b>F28-03AMB</b>	<b>F28-03MMB</b>
1/2"	160	<b>F28-04A</b>	<b>F28-04M</b>	<b>F28-04AMB</b>	<b>F28-04MMB</b>
3/4"	165	<b>F28-06A</b>	<b>F28-06M</b>	<b>F28-06AMB</b>	<b>F28-06MMB</b>

## F30 Jumbo Airline Filters

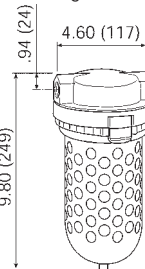

with guard

**Features:**

- 5 micron element
- 2 oz. bowl
- maximum operating conditions:
  - transparent bowl: **150 PSIG** (10.3 bar) and **32°F to 125°F (0°C to 52°C)**
  - metal bowl: **200 PSIG** (13.8 bar) and **32°F to 150°F (0°C to 65.5°C)**

Size	Flow (SCFM)	Transparent Bowl and Guard		Metal Bowl with Sight Glass	
		Automatic Drain Part #	Manual Drain Part #	Automatic Drain Part #	Manual Drain Part #
3/4"	316	<b>F30-06A</b>	<b>F30-06M</b>	<b>F30-06AMB</b>	<b>F30-06MMB</b>
1"	323	<b>F30-08A</b>	<b>F30-08M</b>	<b>F30-08AMB</b>	<b>F30-08MMB</b>

## F35 Jumbo Airline Filters

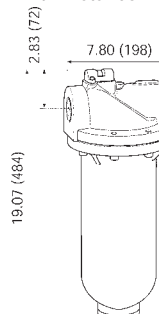

with metal bowl

**Features:**

- 5 micron element
- 12.5 oz. bowl
- maximum operating conditions:
  - metal bowl: **150 PSIG** (10.3 bar) and **32°F to 150°F (0°C to 65.5°C)**

Size	Flow (SCFM)	Heavy Duty Metal Bowl	
		Automatic Drain Part #	Manual Drain Part #
1 1/2"	1280	<b>F35-0BAMB</b>	<b>F35-0BMMB</b>
2"	1400	<b>F35-0CAMB</b>	<b>F35-0CMMB</b>

See pages 401 to 405 for accessories.

**!** FRL's are designed for air service only, unless otherwise indicated.

SCFM ratings at 150 PSIG inlet pressure.



### M16 Compact Coalescing Filters

- removes extremely fine oil mists, oil aerosols and microscopic particles
- A standard airline filter should be installed as a pre-filter when using a coalescing filter.
- 0.5 micron type B and 0.003 micron type D elements are optional
- differential pressure indicator changes from green to red with pressure loss



**Features:**

- 0.01 micron type C element
- 2.7 oz. bowl
- can be installed in modular system
- maximum operating conditions:  
**150 PSIG (10.3 bar) and 32°F to 125°F (0°C to 52°C)**

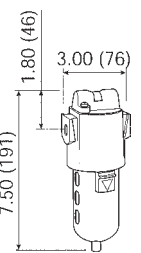

Pneumatic  
Accessories

Size	Flow (SCFM)	With Compact Transparent Bowl and Guard	
		Automatic Drain Part #	Manual Drain Part #
¼"	37.0	<b>M16-02A</b>	<b>M16-02M</b>
⅜"	44.7	<b>M16-03A</b>	<b>M16-03M</b>
½"	46.1	<b>M16-04A</b>	<b>M16-04M</b>

### M18 Compact Coalescing Filters

**Features:**

- high-efficiency removal of water, oil aerosols, and solid particulate contaminants down to 0.01 mg/m<sup>3</sup> with minimum pressure drop
- modern design and appearance
- light weight
- high flow capacity
- 1.72 oz. bowl
- maximum operating conditions:  
**150 PSIG (10.3 bar) and 32°F to 125°F (0°C to 52°C)**

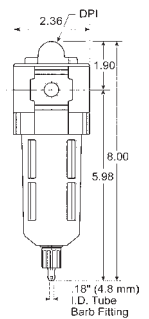

Size	Flow (SCFM)	With Compact Transparent Bowl and Guard	
		Automatic Drain Part #	Manual Drain Part #
¼"	40.0	<b>M18-02A</b>	<b>M18-02M</b>
⅜"	44.0	<b>M18-03A</b>	<b>M18-03M</b>
½"	48.0	<b>M18-04A</b>	<b>M18-04M</b>



### M26 Standard Coalescing Filters

**Features:**

- 0.01 micron type C element
- 1.7 oz. bowl
- can be installed in modular system
- maximum operating conditions:  
**150 PSIG (10.3 bar) and 32°F to 125°F (0°C to 52°C)**

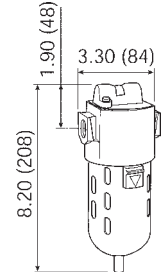

Size	Flow (SCFM)	With Standard Transparent Bowl and Guard	
		Automatic Drain Part #	Manual Drain Part #
¼"	55.0	<b>M26-02A</b>	<b>M26-02M</b>
⅜"	65.5	<b>M26-03A</b>	<b>M26-03M</b>
½"	79.5	<b>M26-04A</b>	<b>M26-04M</b>

See pages 401 to 405 for accessories.

FRL's are designed for air service only, unless otherwise indicated.

SCFM ratings at 150 PSIG inlet pressure.



with guard

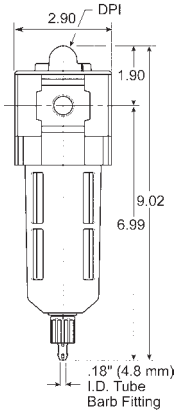

## M28 Standard Coalescing Filters

- removes extremely fine oil mists, oil aerosols and microscopic particles
- A standard airline filter should be installed as a pre-filter when using a coalescing filter.
- 2.87 micron type B and 0.003 micron type D elements are optional
- differential pressure indicator changes from green to red with pressure loss



### Features:

- high-efficiency removal of water, oil aerosols, and solid particulate contaminants down to 0.01 mg/m<sup>3</sup> with minimum pressure drop
- modern design and appearance
- light weight
- high flow capacity
- 6 oz. bowl
- maximum operating conditions:  
**150 PSIG (10.3 bar) and 32°F to 125°F (0°C to 52°C)**

Size	Flow (SCFM)	Compact Transparent Bowl and Guard	
		Automatic Drain Part #	Manual Drain Part #
3/8"	82.0	<b>M28-03A</b>	<b>M28-03M</b>
1/2"	90.0	<b>M28-04A</b>	<b>M28-04M</b>
3/4"	98.0	<b>M28-06A</b>	<b>M28-06M</b>

## M30 Jumbo Coalescing Filters



with guard

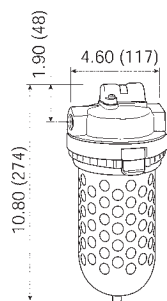

### Features:

- 0.01 micron type C element
- 2 oz. bowl
- maximum operating conditions:  
**150 PSIG (10.3 bar) and 32°F to 125°F (0°C to 52°C)**

Size	Flow (SCFM)	Jumbo Transparent Bowl and Guard	
		Automatic Drain Part #	
1/2"	123	<b>M30-04A</b>	
3/4"	173	<b>M30-06A</b>	
1"	203	<b>M30-08A</b>	

See pages 401 to 405 for accessories.



FRL's are designed for air service only, unless otherwise indicated.

SCFM ratings at 150 PSIG inlet pressure.

## M35 Heavy Duty Coalescing Filters

- for removal of extremely fine oil mists, oil aerosols and microscopic particles
- A standard airline filter should be installed as a pre-filter when using a coalescing filter.
- 1.0 micron type B1 and 0.003 micron type D elements are optional
- differential pressure indicator changes from green to red with pressure loss



**Features:**

- 0.01 micron type C element
- 13.9 oz. bowl
- differential pressure indicator eliminates the guesswork of element placement
- maximum operating conditions:  
**150 PSIG (10.3 bar) and 32°F to 150°F (0°C to 65.5°C)**



M35-0CAMB

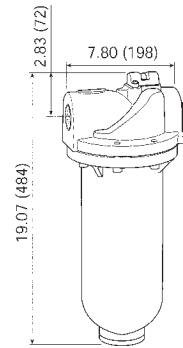

Pneumatic  
Accessories

Size	Flow (SCFM)	Metal Bowl
		Automatic Drain Part #
1½"	710	<b>M35-0BAMB</b>
2"	710	<b>M35-0CAMB</b>

See pages 401 to 405 for accessories.



FRL's are designed for air service only, unless otherwise indicated.

SCFM ratings at 150 PSIG inlet pressure.



with transparent bowl

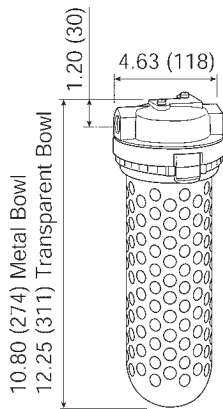

## X03 Manual In-Line Desiccant Dryers

### Applications:

- Manual air dryers are used to remove water vapor from compressed air systems, in applications such as paint spraying, laboratory instruments and small control air systems. Filtration for absorber type dryers is important to protect the desiccant bed from contamination. Cleaner incoming air will result in better performance, longer life and fewer service problems. To regenerate silica gel desiccant, it must be heated to at least **350°F (177°C)** for approximately 3 hours or until color has changed from pink to blue. Allow desiccant to cool to room temperature before pouring back into unit bowl.

An after-filter should be placed downstream from the desiccant dryer to ensure solid contaminants such as desiccant dust do not migrate downstream.



### Features:

- will dry up to 4400 standard cubic feet of air
- desiccant; good for approximately 440 minutes at maximum continuous air flow before regeneration is required
- silica gel changes from blue to pink to indicate the need to replace or regenerate the desiccant
- slotted bowl guard for visual detection of color change
- no electrical connection necessary
- provides atmospheric dew point of **-45°F (-43°C)** with dry desiccant at **100 PSI** and **70°F (21°C)**
- maximum operating conditions:
  - transparent bowl: **150 PSIG** (10.3 bar) and **125°F (52°C)**
  - metal bowl: **150 PSIG** (10.3 bar) and **150°F (66°C)**

Size	Flow (SCFM)	Transparent Bowl Part #	Metal Bowl Part #
¼"	10	<b>X03-02</b>	<b>X03-02MB</b>

## R21 Dial Air Regulators

Dial-air regulators feature a transparent, pressure-calibrated, non-rising adjustment dial for quick adjustment of secondary pressure. The full reduced pressure range can be dialed in less than 270° of dial rotation. This feature is particularly advantageous if secondary pressure must be changed frequently. Dial air regulators can be mounted in any position so dial face is always visible. All dial-air units have a slight constant air bleed.

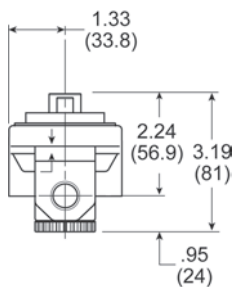

### Features:

- 0-160 PSI adjusting range
- balanced valve design
- relieving type
- non-rising pressure adjusting dial
- piston operated
- two ¼" NPT gauge ports standard on models without gauge, one ¼" NPT gauge port standard on models with gauge - can be used for additional outlet ports.
- models supplied without gauge use a GC230 gauge
- maximum operating pressure: **300 PSIG** (20.7 bar)
- temperature range: **32°F to 150°F (0°C to 66°C)**

Size	Flow (SCFM)	With Gauge Part #	Without Gauge Part #
¼"	117	<b>R21-02RG</b>	<b>R21-02R</b>
⅜"	180	<b>R21-03RG</b>	<b>R21-03R</b>
½"	195	<b>R21-04RG</b>	<b>R21-04R</b>
¾"	220	<b>R21-06RG</b>	<b>R21-06R</b>

See pages 401 to 405 for accessories.



FRL's are designed for air service only, unless otherwise indicated.

SCFM ratings at 100 PSIG inlet pressure.

## R16 Compact Regulators

**Features:**

- 0-125 PSI adjusting range
- for 0-60 PSI range consult Dixon®
- self-relieving standard
- can be installed with the adjusting knob in any position
- To increase regulated pressure, pull adjusting knob up and turn clockwise. To reduce pressure, turn knob counter clockwise.
- two ¼" NPT gauge ports standard on models without gauge, one ¼" NPT gauge port standard on models with gauge - can be used for additional outlet ports
- models supplied without gauge use a GC230 gauge
- maximum operating conditions:  
**300 PSIG (20.7 bar) and 32°F to 150°F (0°C to 66°C)**

Size	Flow (SCFM)	With Gauge Part #	Without Gauge Part #
¼"	71.5	<b>R16-02RG</b>	<b>R16-02R</b>
⅜"	80.5	<b>R16-03RG</b>	<b>R16-03R</b>
½"	88.0	<b>R16-04RG</b>	<b>R16-04R</b>

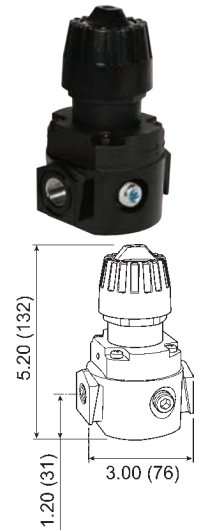

Pneumatic Accessories

## R16 High Pressure Compact Regulators

**Features:**

- 0-250 PSI adjusting range
- self-relieving standard
- non-rising push/pull locking adjustment knob
- panel mount nut standard
- excellent flow characteristics
- can be installed with the adjusting knob in any position
- two ¼" NPT gauge ports standard on models without gauge, one ¼" NPT gauge port standard on models with gauge - can be used for additional outlet ports
- models supplied without gauge use a GC240 gauge
- maximum operating conditions:  
**300 PSIG (20.7 bar) and 32°F to 150°F (0°C to 66°C)**

Size	Flow (SCFM)	With Gauge Part #	Without Gauge Part #
¼"	71.5	<b>R16-02RHG</b>	<b>R16-02RH</b>
⅜"	80.5	<b>R16-03RHG</b>	<b>R16-03RH</b>
½"	88.0	<b>R16-04RHG</b>	<b>R16-04RH</b>

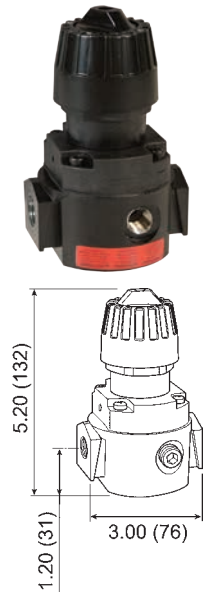

## R18 Compact Regulators

**Features:**

- 0-125 PSI adjusting range
- self-relieving standard
- can be installed with the adjusting knob in any position
- To increase regulated pressure, pull adjusting knob up and turn clockwise. To reduce pressure, turn knob counter clockwise.
- Two ¼" NPT gauge ports located on the front and rear faces of the body; ports may be used as additional regulated ports or for pressure gauges.
- models supplied without gauge use a GC230 gauge
- maximum operating conditions:  
**300 PSIG (20.7 bar) and 32°F to 150°F (0°C to 66°C)**

Size	Flow (SCFM)	With Gauge Part #	Without Gauge Part #
¼"	82	<b>R18-02RG</b>	<b>R18-02R</b>
⅜"	97	<b>R18-03RG</b>	<b>R18-03R</b>
½"	97	<b>R18-04RG</b>	<b>R18-04R</b>



See pages 401 to 405 for accessories.

FRL's are designed for air service only, unless otherwise indicated.

SCFM ratings at 100 PSIG inlet pressure.

## R26 Standard Regulators

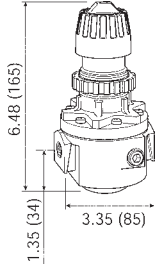
**Features:**

- 0-125 PSI adjusting range
- non-rising push/pull locking adjustment knob
- panel mount nut standard
- excellent flow characteristics
- can be installed with the adjusting knob in any position
- To increase regulated pressure, pull adjusting knob up and turn clockwise. To reduce pressure, turn knob counter clockwise.
- two 1/4" NPT gauge ports standard on models without gauge, one 1/4" NPT gauge port standard on models with gauge - can be used for additional outlet ports
- models supplied without gauge use a GC230 gauge
- maximum operating conditions:  
**300 PSIG (20.7 bar) and 32°F to 150°F (0°C to 66°C)**

Size	Flow (SCFM)	With Gauge	Without Gauge
		Part #	Part #
1/4"	112	<b>R26-02RG</b>	<b>R26-02R</b>
3/8"	148	<b>R26-03RG</b>	<b>R26-03R</b>
1/2"	185	<b>R26-04RG</b>	<b>R26-04R</b>

## R26 High Pressure Standard Regulators

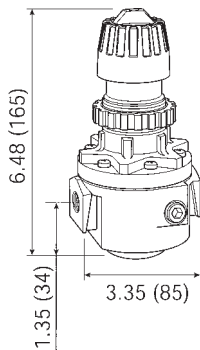
**Features:**

- 0-250 PSI adjusting range
- self-relieving standard
- non-rising push/pull locking adjustment knob
- panel mount nut standard
- excellent flow characteristics
- can be installed with the adjusting knob in any position
- two 1/4" NPT gauge ports standard on models without gauge, one 1/4" NPT gauge port standard on models with gauge can be used for additional outlet ports
- models supplied without gauge use a GC240 gauge
- maximum operating conditions: **300 PSIG (20.7 bar) and 32°F to 150°F (0°C to 66°C)**

Size	Flow (SCFM)	With Gauge	Without Gauge
		Part #	Part #
1/4"	112	<b>R26-02RHG</b>	<b>R26-02RH</b>
3/8"	148	<b>R26-03RHG</b>	<b>R26-03RH</b>
1/2"	185	<b>R26-04RHG</b>	<b>R26-04RH</b>

See pages 401 to 405 for accessories.



FRL's are designed for air service only, unless otherwise indicated.

SCFM ratings at 100 PSIG inlet pressure.

## R28 Standard Regulators

**Features:**

- 0-125 PSI adjusting range
- self-relieving standard
- four adjusting pressure ranges available
- To increase regulated pressure, pull adjusting knob up and turn clockwise. To reduce pressure, turn knob counter clockwise.
- Two ¼" NPT gauge ports located on the front and rear faces of the body; ports may be used as additional regulated ports or for pressure gauges.
- models supplied without gauge use a GC230 gauge
- maximum operating conditions:  
**300 PSIG (20.7 bar) and 32°F to 150°F (0°C to 66°C)**



Size	Flow (SCFM)	With Gauge Part #	Without Gauge Part #
¾"	162	<b>R28-03RG</b>	<b>R28-03R</b>
½"	170	<b>R28-04RG</b>	<b>R28-04R</b>
¾"	176	<b>R28-06RG</b>	<b>R28-06R</b>

Pneumatic Accessories

## R30 High Flow Regulators

**Features:**

- 0-125 PSI adjusting range
- self-relieving standard
- piston operated
- can be installed with the adjusting knob in any position
- To increase regulated pressure, pull adjusting knob up and turn clockwise. To reduce pressure, turn knob counter clockwise.
- two ¼" NPT gauge ports standard on models without gauge, one ¼" NPT gauge port standard on models with gauge - can be used for additional outlet ports
- models supplied without gauge use a GC230 gauge
- maximum operating conditions:  
**300 PSIG (20.7 bar) and 32°F to 150°F (0°C to 66°C)**

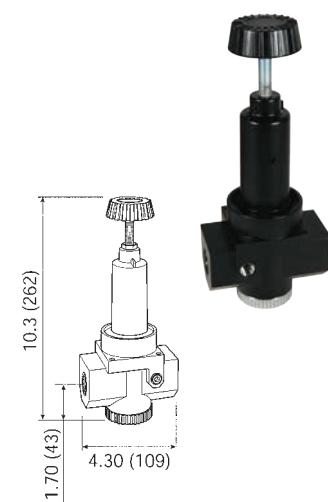

Size	Flow (SCFM)	With Gauge Part #	Without Gauge Part #
¾"	481	<b>R30-06RG</b>	<b>R30-06R</b>
1"	500	<b>R30-08RG</b>	<b>R30-08R</b>



## R30 High Pressure High Flow Regulators

**Features:**

- 0-180 PSI adjusting range
- self-relieving standard
- piston operated
- can be installed with the adjusting knob in any position
- To increase regulated pressure, pull adjusting knob up and turn clockwise. To reduce pressure, turn knob counter clockwise.
- two ¼" NPT gauge ports standard on models without gauge, one ¼" NPT gauge port standard on models with gauge - can be used for additional outlet ports
- models supplied without gauge use a GC240 gauge
- maximum operating conditions:  
**300 PSIG (20.7 bar) and 32°F to 150°F (0°C to 66°C)**

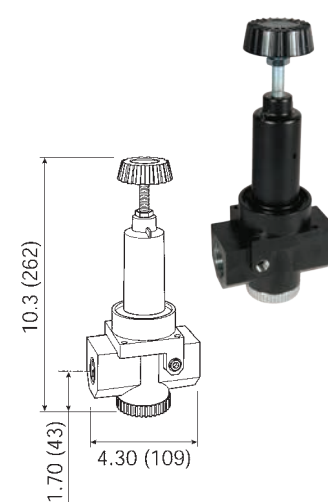

Size	Flow (SCFM)	With Gauge Part #	Without Gauge Part #
¾"	481	<b>R30-06RHG</b>	<b>R30-06RH</b>
1"	500	<b>R30-08RHG</b>	<b>R30-08RH</b>

See pages 401 to 405 for accessories.

FRL's are designed for air service only, unless otherwise indicated.

SCFM ratings at 100 PSIG inlet pressure.

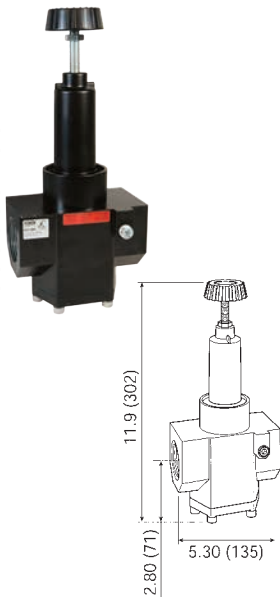

## R40 High Flow Regulators

**Features:**

- 0-125 PSI adjusting range
- self-relieving standard
- piston operated
- can be installed with the adjusting knob in any position
- To increase regulated pressure, pull adjusting knob up and turn clockwise. To reduce pressure, turn knob counter clockwise.
- two ¼" NPT gauge ports standard on models without gauge, one ¼" NPT gauge port standard on models with gauge - can be used for additional outlet ports
- models supplied without gauge use a GC230 gauge
- maximum operating conditions:  
**300 PSIG (20.7 bar) and 32°F to 150°F (0°C to 66°C)**

Size	Flow (SCFM)	With Gauge Part #	Without Gauge Part #
1½"	1200	<b>R40-0BRG</b>	<b>R40-0BR</b>
2"	1200	<b>R40-0CRG</b>	<b>R40-0CR</b>

## R40 High Pressure High Flow Regulators

**Features:**

- 0-180 PSI adjusting range
- self-relieving standard
- piston operated
- can be installed with the adjusting knob in any position
- To increase regulated pressure, pull adjusting knob up and turn clockwise. To reduce pressure, turn knob counter clockwise.
- two ¼" NPT gauge ports standard on models without gauge, one ¼" NPT gauge port standard on models with gauge - can be used for additional outlet ports
- models supplied without gauge use a GC240 gauge
- maximum operating conditions:  
**300 PSIG (20.7 bar) and 32°F to 150°F (0°C to 66°C)**

Size	Flow (SCFM)	With Gauge Part #	Without Gauge Part #
1½"	1200	<b>R40-0BRHG</b>	<b>R40-0BRH</b>
2"	1200	<b>R40-0CRHG</b>	<b>R40-0CRH</b>

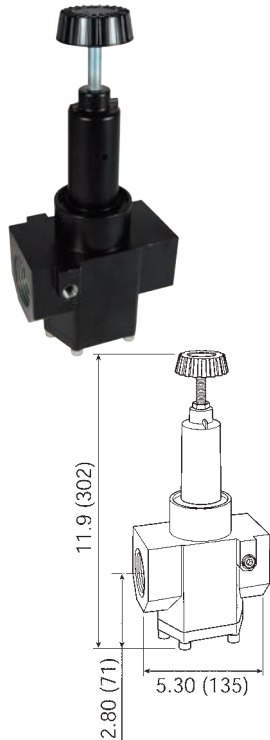

See pages 401 to 405 for accessories.

**!** FRL's are designed for air service only, unless otherwise indicated.

SCFM ratings at 100 PSIG inlet pressure.



## CB6 Compact Filter / Regulators

Over-under units are space savers and provide for installation in tight areas. One common inlet/outlet for both filter and regulator saves on piping costs.

**Features:**

- 0-125 PSIG adjusting range
- 5 micron reusable element
- self-relieving standard
- diaphragm operated
- quick-disconnect bowl guard with integral plastic bowl and safety latch standard
- Two ¼" gauge ports are provided in either side of the regulator body for installation of a gauge or to use as an additional outlet port. Plug unused port(s).
- supplied with GC230 gauge
- maximum operating conditions:
  - transparent bowl: **150 PSIG** (10.3 bar) and **32°F to 125°F (0°C to 52°C)**
  - metal bowl: **200 PSIG** (13.8 bar) and **32°F to 150°F (0°C to 66°C)**

Size	Flow (SCFM)	Transparent Bowl and Guard		Metal Bowl with Sight Glass	
		Automatic Drain Part #	Manual Drain Part #	Automatic Drain Part #	Manual Drain Part #
¼"	64	<b>CB6-02AG</b>	<b>CB6-02MG</b>	<b>CB6-02AGMB</b>	<b>CB6-02MGMB</b>
⅜"	70	<b>CB6-03AG</b>	<b>CB6-03MG</b>	<b>CB6-03AGMB</b>	<b>CB6-03MGMB</b>
½"	70	<b>CB6-04AG</b>	<b>CB6-04MG</b>	<b>CB6-04AGMB</b>	<b>CB6-04MGMB</b>



with guard

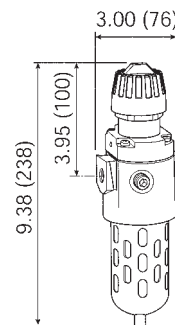

Pneumatic Accessories

## B18 Compact Filter / Regulators

**Features:**

- 5-125 PSIG adjusting range for transparent bowl with guard
- 10-250 PSIG adjusting range for metal bowl with sight glass
- 5 micron element
- 1.72 oz. bowl
- self-relieving standard
- spring-loaded diaphragm
- To increase regulated pressure, pull adjusting knob and turn clockwise. To reduce pressure, turn knob counter clockwise. To lock knob, push down.
- Two ¼" gauge ports located on the front and rear faces of the body. These ports may be used as additional regulated ports or for pressure gauges. Plug unused port(s).
- transparent bowl supplied with GC230 gauge
- metal bowl supplied with GC240 gauge
- maximum operating conditions:
  - transparent bowl: **150 PSIG** (10.3 bar) and **32°F to 125°F (0°C to 52°C)**
  - metal bowl: **250 PSIG** (17.2 bar) and **32°F to 150°F (0°C to 66°C)**

Size	Flow (SCFM)	Transparent Bowl and Guard		Metal Bowl with Sight Glass	
		Automatic Drain Part #	Manual Drain Part #	Automatic Drain Part #	Manual Drain Part #
¼"	88	<b>B18-02AG</b>	<b>B18-02MG</b>	<b>B18-02AGMB</b>	<b>B18-02MGMB</b>
⅜"	117	<b>B18-03AG</b>	<b>B18-03MG</b>	<b>B18-03AGMB</b>	<b>B18-03MGMB</b>
½"	121	<b>B18-04AG</b>	<b>B18-04MG</b>	<b>B18-04AGMB</b>	<b>B18-04MGMB</b>



with metal bowl

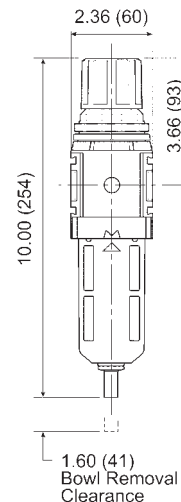

See pages 401 to 405 for accessories.

FRL's are designed for air service only, unless otherwise indicated.

SCFM ratings at 100 PSIG inlet pressure.

## B28 Standard Filters/Regulators

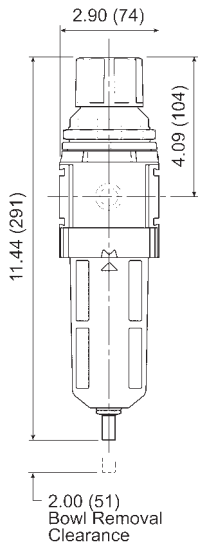

with transparent bowl

**Features:**

- 5-125 PSIG adjusting range for transparent bowl with guard
- 10-250 PSIG adjusting range for metal bowl with sight glass
- 5 micron element
- 2.87 oz. bowl
- self-relieving standard
- spring-loaded diaphragm
- To increase regulated pressure, pull adjusting knob and turn clockwise. To reduce pressure, turn knob counter clockwise. To lock knob, push down.
- Two 1/4" gauge ports located on the front and rear faces of the body. These ports may be used as additional regulated ports or for pressure gauges. Plug unused port(s).
- transparent bowl supplied with GC230 gauge
- metal bowl supplied with GC240 gauge
- maximum operating conditions:
  - transparent bowl: **150 PSIG** (10.3 bar) and **32°F to 125°F (0°C to 52°C)**
  - metal bowl: **250 PSIG** (17.2 bar) and **32°F to 150°F (0°C to 66°C)**

Size	Flow (SCFM)	Transparent Bowl and Guard		Metal Bowl with Sight Glass	
		Automatic Drain Part #	Manual Drain Part #	Automatic Drain Part #	Manual Drain Part #
3/8"	140	<b>B28-03AG</b>	<b>B28-03MG</b>	<b>B28-03AGMB</b>	<b>B28-03MGMB</b>
1/2"	165	<b>B28-04AG</b>	<b>B28-04MG</b>	<b>B28-04AGMB</b>	<b>B28-04MGMB</b>
3/4"	175	<b>B28-06AG</b>	<b>B28-06MG</b>	<b>B28-06AGMB</b>	<b>B28-06MGMB</b>

See pages 401 to 405 for accessories.  
SCFM ratings at 100 PSIG inlet pressure.

## L16 EconOmist® Compact Lubricators



transparent bowl with guard

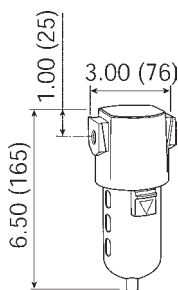

Designed so that all the oil flow observed in the sight dome is broken into a mist and delivered via the airflow to the application. The oil in the bowl can be filled or replenished without interrupting airflow or bleeding pressure from the system. Once the oil-fill cap is removed, the bowl is depressurized and isolated from line pressure, and the bowl itself can then be removed for faster refill, if desired. The bowl can be filled right to the top.

**Features:**

- 5 oz. bowl
- full view sight dome
- fill under pressure design
- maximum operating conditions:
  - transparent bowl: **150 PSIG** (10.3 bar) and **32°F to 125°F (0°C to 52°C)**
  - metal bowl: **200 PSIG** (13.8 bar) and **32°F to 150°F (0°C to 66°C)**

Size	Flow (SCFM)	Transparent Bowl Part #	Metal Bowl Part #
1/4"	36.1	<b>L16-02A</b>	<b>L16-02AMB</b>
3/8"	58.5	<b>L16-03A</b>	<b>L16-03AMB</b>
1/2"	64.0	<b>L16-04A</b>	<b>L16-04AMB</b>

See pages 401 to 405 for accessories.  
See page 367 for air tool lubricant.

**!** FRL's are designed for air service only, unless otherwise indicated.

SCFM ratings at 150 PSIG inlet pressure.

**Flow Guide®**

The elastomer disc-shaped device is located in the throat of all Wilkerson lubricators and automatically maintains a constant ratio of oil flow to airflow regardless of changing rates of airflow. This allows one lubricator to serve several pneumatic components operating together or intermittently.

**Type of oil to use:**

For all Wilkerson lubricators, use any petroleum-base, non-detergent light weight oil (SAE 10/150SSU) which will readily break up into a mist, i.e., Mobil DTE light or comparable oil. Do not use synthetic oil or any oils containing additives or solvents. See page 367 for air tool lubricants.

### L18 EconOmist® Compact Lubricators

**Features:**

- 4 oz. bowl
- manual drain
- high flow capacity
- can be filled under pressure
- To adjust and set oil delivery rate the unit must be pressurized and air must be flowing through the unit. Turn the sight dome, located on the top of the unit, counter clockwise to initiate oil delivery. The rate of oil delivery depends on air flow rate. If flow increases or decreases, the oil delivery rate will increase or decrease proportionally. Turning the sight dome clockwise will stop all oil delivery.
- maximum operating conditions:
  - transparent bowl: **150 PSIG** (10.3 bar) and **32°F to 125°F (0°C to 52°C)**
  - metal bowl: **250 PSIG** (17.2 bar) and **32°F to 150°F (0°C to 66°C)**

Size	Flow (SCFM)	Transparent Bowl Part #	Metal Bowl Part #
¼"	88	<b>L18-02A</b>	<b>L18-02AMB</b>
⅜"	90	<b>L18-03A</b>	<b>L18-03AMB</b>
½"	96	<b>L18-04A</b>	<b>L18-04AMB</b>

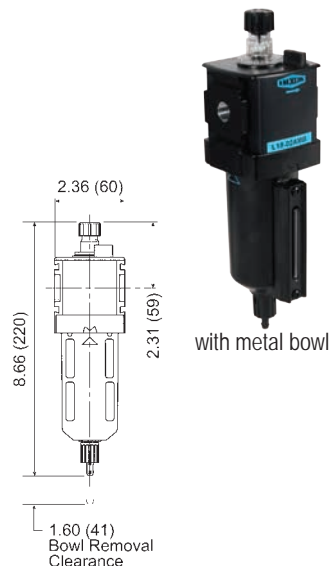

### L26 EconOmist® Standard Lubricators

**Features:**

- 10 oz. bowl
- adjustable oil feed
- can be filled under pressure
- quick-disconnect metal bowl guard with integral safety latch
- siphon tube filter provides clean lubricant downstream
- The rate of oil delivery may be controlled by turning the adjusting screw counter clockwise for more and clockwise for less oil delivery. If flow increases or decreases, the oil delivery rate will increase or decrease proportionally.
- maximum operating conditions:
  - transparent bowl: **150 PSIG** (10.3 bar) and **32°F to 125°F (0°C to 52°C)**
  - metal bowl: **200 PSIG** (13.8 bar) and **32°F to 150°F (0°C to 66°C)**

Size	Flow (SCFM)	Transparent Bowl Part #	Metal Bowl <sup>1</sup> Part #
¼"	35	<b>L26-02A</b>	<b>L26-02AMB</b>
⅜"	60	<b>L26-03A</b>	<b>L26-03AMB</b>
½"	128	<b>L26-04A</b>	<b>L26-04AMB</b>

<sup>1</sup> metal bowl has sight gauge with brass petcock drain

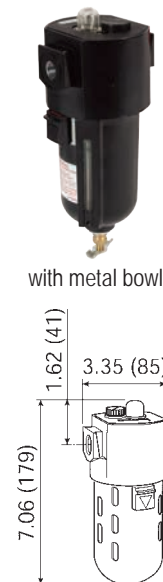

See pages 401 to 405 for accessories.

See page 367 for air tool lubricant.

FRL's are designed for air service only, unless otherwise indicated.

SCFM ratings at 150 PSIG inlet pressure.

## L28 EconOmist® Standard Lubricators

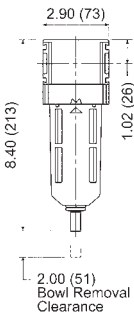

with metal bowl

**Features:**

- 6.11 oz. bowl
- manual drain
- high flow capacity
- can be filled under pressure
- To adjust and set oil delivery rate the unit must be pressurized and air must be flowing through the unit. Turn the sight dome, located on the top of the unit, counter clockwise to initiate oil delivery. If flow increases or decreases, the oil delivery rate will increase or decrease proportionally. Turning the sight dome clockwise will stop all oil delivery.
- maximum operating conditions:
  - transparent bowl: **150 PSIG** (10.3 bar) and **32°F to 125°F (0°C to 52°C)**
  - metal bowl: **250 PSIG** (17.2 bar) and **32°F to 150°F (0°C to 66°C)**

Size	Flow (SCFM)	Transparent Bowl Part #	Metal Bowl Part #
3/8"	176	<b>L28-03A</b>	<b>L28-03AMB</b>
1/2"	184	<b>L28-04A</b>	<b>L28-04AMB</b>
3/4"	200	<b>L28-06A</b>	<b>L28-06AMB</b>

SCFM ratings at 150 PSIG inlet pressure.

## L30 EconOmist® Standard Lubricators

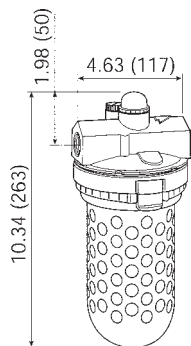

with metal bowl

**Features:**

- 26 oz. bowl
- transparent bowl: no drain  
metal bowl: manual brass petcock drain
- can be filled under pressure
- The rate of oil delivery may be controlled by turning the adjusting screw counter clockwise for more and clockwise for less oil delivery. The oil delivery rate will change automatically to deliver more oil during higher air flows and less oil for air flows lower than the one at which the setting was made.
- maximum operating conditions:
  - transparent bowl: **150 PSIG** (10.3 bar) and **32°F to 125°F (0°C to 52°C)**
  - metal bowl: **200 PSIG** (13.8 bar) and **32°F to 150°F (0°C to 66°C)**

Size	Flow (SCFM)	Transparent Bowl Part #	Metal Bowl Part #
3/4"	196	<b>L30-06A</b>	<b>L30-06AMB</b>
1"	374	<b>L30-08A</b>	<b>L30-08AMB</b>

SCFM ratings at 120 PSIG inlet pressure.

See pages 401 to 405 for accessories.  
See page 367 for air tool lubricant.

 FRL's are designed for air service only, unless otherwise indicated.

## L40 & L50 EconOmist® Standard Lubricators

**Features:**

- 26 oz. bowl
- transparent bowl: solid bottom  
metal bowl: manual drain with sight glass
- full view sight dome
- adjustable oil feed
- can be filled under pressure
- quick-disconnect clamp ring for easy bowl removal
- The rate of oil delivery may be controlled by turning the adjusting screw counter clockwise for more and clockwise for less oil delivery. The oil delivery rate will change automatically to deliver more oil during higher air flows and less oil for air flows lower than the one at which the setting was made.
- maximum operating conditions:
  - transparent bowl: **150 PSIG** (10.3 bar) and **32°F to 125°F (0°C to 52°C)**
  - metal bowl: **200 PSIG** (13.8 bar) and **32°F to 150°F (0°C to 66°C)**

Size	Flow (SCFM)	Transparent Bowl Part #	Metal Bowl with Sight Glass Part #
1½"	927	<b>L40-0BA</b>	<b>L40-0BAMB</b>
2"	1186	<b>L50-0CA</b>	<b>L50-0CAMB</b>



transparent bowl with guard

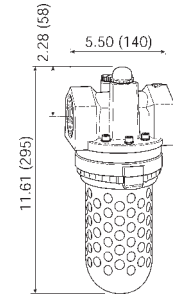

illustration represents L40 series

See pages 401 to 405 for accessories.  
See page 367 for air tool lubricant.

FRL's are designed for air service only, unless otherwise indicated.  
SCFM ratings at 120 PSIG inlet pressure.

Pneumatic Accessories

## C16 Compact Combination Units

**Features:**

- maximum operating conditions:
  - transparent bowl: **150 PSIG** (10.3 bar) and **32°F to 125°F (0°C to 52°C)**
  - metal bowl: **200 PSIG** (13.8 bar) and **32°F to 175°F (0°C to 80°C)**
- Included components:
  - (2) modular sleeves
  - (2) mounting brackets (sleeve and bracket)
  - (2) end blocks

Filter series F16:

- 5 micron element
- 2.7 oz. bowl

Regulator series R16:

- 0-125 PSI adjusting range
- self-relieving
- supplied with a GC230 gauge

Lubricator series L16:

- 5 oz. bowl
- adjustable oil feed
- full view sight dome

Size	Flow (SCFM)	Transparent Bowl and Guard		Metal Bowl with Sight Glass	
		Automatic Drain Part #	Manual Drain Part #	Automatic Drain Part #	Manual Drain Part #
¼"	36.1	<b>C16-02A</b>	<b>C16-02M</b>	<b>C16-02AMB</b>	<b>C16-02MMB</b>
⅜"	58.5	<b>C16-03A</b>	<b>C16-03M</b>	<b>C16-03AMB</b>	<b>C16-03MMB</b>
½"	64.0	<b>C16-04A</b>	<b>C16-04M</b>	<b>C16-04AMB</b>	<b>C16-04MMB</b>



transparent bowl with guard

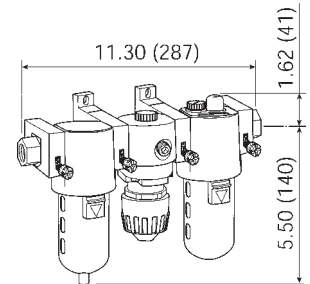

FRL's are designed for air service only, unless otherwise indicated.  
SCFM ratings at 150 PSIG inlet pressure.



with metal bowl

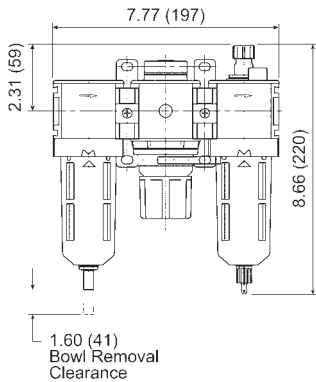

## C18 Compact Combination Units

### Features:

- maximum operating conditions:
  - transparent bowl: **150 PSIG** (10.3 bar) and **32°F to 125°F (0°C to 52°C)**
  - metal bowl: **250 PSIG** (17.2 bar) and **32°F to 150°F (0°C to 66°C)**
- Included components:
  - (2) end blocks
  - (2) mounting brackets with joiner set and port O-ring

### Filter series F18:

- 5 micron element
- 1.72 oz. bowl

### Regulator series R18:

- 0-125 PSI adjusting range
- self-relieving
- supplied with a GC230 gauge

### Lubricator series L18:

- 4 oz. bowl
- adjustable oil feed
- full view sight dome

Size	Flow (SCFM)	Transparent Bowl and Guard		Metal Bowl with Sight Glass	
		Automatic Drain Part #	Manual Drain Part #	Automatic Drain Part #	Manual Drain Part #
¼"	110	<b>C18-02A</b>	<b>C18-02M</b>	<b>C18-02AMB</b>	<b>C18-02MMB</b>
⅜"	160	<b>C18-03A</b>	<b>C18-03M</b>	<b>C18-03AMB</b>	<b>C18-03MMB</b>
½"	160	<b>C18-04A</b>	<b>C18-04M</b>	<b>C18-04AMB</b>	<b>C18-04MMB</b>

## C26 Standard Combination Units

### Features:

- maximum operating conditions:
  - transparent bowl: **150 PSIG** (10.3 bar) and **32°F to 125°F (0°C to 52°C)**
  - metal bowl: **200 PSIG** (13.8 bar) and **32°F to 175°F (0°C to 80°C)**
- Included components:
  - (2) modular sleeves
  - (2) mounting brackets (sleeve and bracket)
  - (2) end blocks

### Filter series F26:

- 5 micron element
- 3.2 oz. bowl

### Regulator series R26:

- 0-125 PSI adjusting range
- self-relieving
- supplied with a GC230 gauge

### Lubricator series L26:

- 10 oz. bowl
- adjustable oil feed
- full view sight dome



with metal bowl

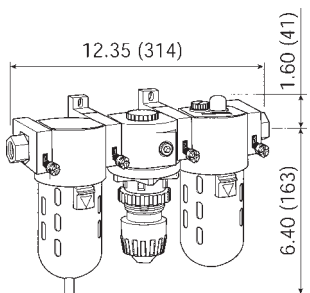

Size	Flow (SCFM)	Transparent Bowl and Guard		Metal Bowl	
		Automatic Drain Part #	Manual Drain Part #	Automatic Drain Part #	Manual Drain Part #
¼"	35	<b>C26-02A</b>	<b>C26-02M</b>	<b>C26-02AMB</b>	<b>C26-02MMB</b>
⅜"	60	<b>C26-03A</b>	<b>C26-03M</b>	<b>C26-03AMB</b>	<b>C26-03MMB</b>
½"	128	<b>C26-04A</b>	<b>C26-04M</b>	<b>C26-04AMB</b>	<b>C26-04MMB</b>

⚠ FRL's are designed for air service only, unless otherwise indicated.

SCFM ratings at 150 PSIG inlet pressure.

## C28 Standard Combination Units

**Features:**

- modern design and appearance
- quick disconnect bowl / bowl guard
- maximum operating conditions:
  - transparent bowl: **150 PSIG** (10.3 bar) and **32°F to 150°F (0°C to 65.5°C)**
  - metal bowl: **250 PSIG** (17.2 bar) and **32°F to 150°F (0°C to 66°C)**
- Included components:
  - (2) end blocks
  - (2) mounting brackets with joiner set and port O-ring

Filter series F28:

- 5 micron element
- 2.87 oz. bowl

Regulator series R28:

- 0-125 PSI adjusting range
- self-relieving
- supplied with a GC230 gauge

Lubricator series L28:

- 6 oz. bowl
- adjustable oil feed
- full view sight dome

Size	Flow (SCFM)	Transparent Bowl and Guard		Metal Bowl	
		Automatic Drain Part #	Manual Drain Part #	Automatic Drain Part #	Manual Drain Part #
3/8"	150	<b>C28-03A</b>	<b>C28-03M</b>	<b>C28-03AMB</b>	<b>C28-03MMB</b>
1/2"	175	<b>C28-04A</b>	<b>C28-04M</b>	<b>C28-04AMB</b>	<b>C28-04MMB</b>
3/4"	175	<b>C28-06A</b>	<b>C28-06M</b>	<b>C28-06AMB</b>	<b>C28-06MMB</b>

SCFM ratings given at 150 PSIG inlet pressure.



with metal bowl

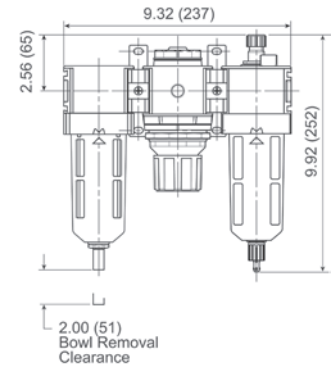

## C31 Jumbo Combination Units

**Features:**

- high flow capacity
- large bowl reservoir
- maximum operating conditions:
  - transparent bowl: **150 PSIG** (10.3 bar) and **32°F to 125°F (0°C to 52°C)**
  - metal bowl: **200 PSIG** (13.8 bar) and **32°F to 175°F (0°C to 80°C)**
- Included components:
  - (2) brass hex nipples

Filter series F30:

- 5 micron element
- 2 oz. bowl

Regulator series R30:

- 0-125 PSI adjusting range
- self-relieving
- supplied with a GC230 gauge

Lubricator series L30:

- 26 oz. bowl
- adjustable oil feed
- full view sight dome

Size	Flow (SCFM)	Transparent Bowl and Guard		Metal Bowl with Sight Glass	
		Automatic Drain Part #	Manual Drain Part #	Automatic Drain Part #	Manual Drain Part #
3/4"	374	<b>C31-06A</b>	<b>C31-06M</b>	<b>C31-06AMB</b>	<b>C31-06MMB</b>
1"	374	<b>C31-08A</b>	<b>C31-08M</b>	<b>C31-08AMB</b>	<b>C31-08MMB</b>



with metal bowl

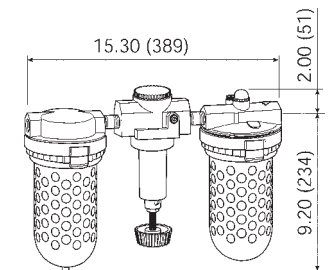

FRL's are designed for air service only, unless otherwise indicated.

SCFM ratings given at 120 PSIG inlet pressure.

### D18 Combination Units

Pneumatic  
Accessories



with transparent bowl and guard

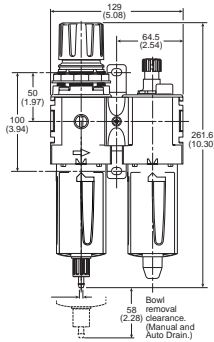

**Features:**

- light weight, Ready-to-Mount assembly comes standard with pressure gauge and modular T-Bracket/Joiner Assembly
- components integrated into single unit
- modern design and appearance
- quick disconnect bowl / bowl guard
- maximum operating conditions:
  - transparent bowl: **150 PSIG** (10.3 bar) and **32°F to 125°F (0°C to 52°C)**
  - metal bowl: **250 PSIG** (17.2 bar) and **32°F to 150°F (0°C to 66°C)**
- 5 micron element
- 4 oz. bowl/lubricator

**Regulator**

- 0-125 PSI adjusting range
- self-relieving
- supplied with gauge
- 1.72 oz. bowl/filter

Size	Flow (SCFM)	Transparent Bowl and Guard	Metal Bowl / Sight Gauge
		Manual Drain Part #	Manual Drain Part #
1/2"	175	<b><i>D18-04M</i></b>	<b><i>D18-04MMB</i></b>

SCFM ratings at 150 PSIG inlet pressure.

### D28 Combination Units



with metal bowl

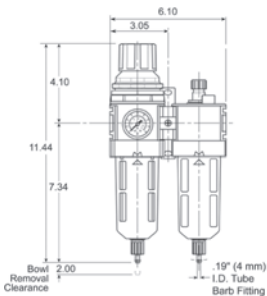

**Features:**

- light weight, Ready-to-Mount assembly comes standard with pressure gauge and modular T-Bracket/Joiner Assembly
- components integrated into single unit
- modern design and appearance
- quick disconnect bowl / bowl guard
- maximum operating conditions:
  - **250 PSIG** (17.2 bar) and **32°F to 150°F (0°C to 66°C)**
- 5 micron element
- 6 oz. bowl/lubricator

**Regulator**

- 0-125 PSI adjusting range
- self-relieving
- supplied with gauge
- 2.87 oz. bowl/filter

Size	Flow (SCFM)	Metal Bowl / Sight Gauge
		Manual Drain Part #
1/2"	110	<b><i>D28-04MMB</i></b>
3/4"	130	<b><i>D28-06MMB</i></b>

**!** FRL's are designed for air service only, unless otherwise indicated.

SCFM ratings given at 150 PSIG inlet pressure.



## C31 Combination Unit with Protective Frame

**Application:**

Provides downstream air preparation with protection and convenience.

**Features:**

Include components:

- C31-08AMB 1" FRL with metal bowls and auto drain filter
- BBLV100 1" brass ball valve and AM12 air king on inlet port
- BBV100DTW 3-way ball valve installed between regulator and lubricator provides option for non-lubricated air
- heavy duty frame protects air prep components
- operating:
  - maximum pressure: **250 PSIG**
  - temperature range: **40°F to 150°F (4°C to 66°C)**
  - flow: 320 SCFM



Pneumatic Accessories

Size	Part #
1"	<b>C31-08FRAME</b>

## F23 Exhaust Muffler

**Features:**

- The contaminants in the exhaust flow are mechanically separated and twice filtered to 5 micron levels. The clean, muffled exhaust flows out of the unit under the metal hood on top.
- removes oily aerosols from exhaust flows
- one inlet port
- 5 micron element
- quick disconnect clamp ring for easy bowl removal
- manual drain
- operating:
  - maximum pressure: **150 PSIG (10.3 bar)**
  - temperature range: **32°F to 125°F (0°C to 52°C)**

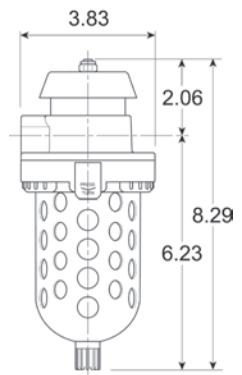

Size	Flow @ 90 PSI	Transparent Bowl with Guard Part #
½"	240 SCFM	<b>F23-04M</b>



FRL's are designed for air service only, unless otherwise indicated.



with metal bowl

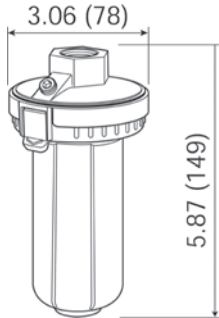

## X02 Automatic Drains

As liquid contaminants collect in the bowl, they raise a closed-cell cellular float. When the liquid level reaches a given point, the float triggers a mechanism which pilots line pressure against a large area piston or diaphragm which snaps open the drain valve. The contaminants are discharged from the drain orifice at line pressure. As the liquid level falls, the pilot valve closes, line pressure against the piston/diaphragm returns to atmosphere and the drain valve snaps closed.

### Features:

- 5 oz. bowl
- fully automatic, float operated
- full ½" NPT drain inlet
- quick-disconnect clamp ring for easy bowl removal when servicing
- no electrical connections
- easy installation
- maximum operating conditions:
  - transparent bowl: **150 PSIG** (10.3 bar) and **32°F to 125°F (0°C to 52°C)**
  - metal bowl: **200 PSIG** (13.8 bar) and **32°F to 150°F (0°C to 66°C)**

Size	Transparent Bowl Part #	Metal Bowl Part #
½"	<b>X02-04</b>	<b>X02-04MB</b>

## Lockout Valves

### Application:

Lockout valves are installed in pneumatic drop legs, or individual pneumatic control lines. In accordance with OSHA procedures, lockout valves are used during maintenance and service procedures of pneumatically (air) operated equipment.



### Features:

- used to comply with OSHA 29 CFR part 1910
- built in port for pressure verification to meet ANSI B11 and Pmm155 requirements
- inline or surface mountable
- yellow cast aluminum body with red handle
- pressure range: **15-300 PSI**
- temperature range: **40°F to 175°F (4°C to 79°C)**

Port In/Out	Port Exhaust	Part #
½"	¾"	<b>LV4N6D</b>
¾"	¾"	<b>LV6N6D</b>
¾"	1¼"	<b>LV6NAD</b>
1"	1¼"	<b>LV8NAD</b>

### Filter Elements

Used On	Description	Part #
F03	5 micron element	<b>PS403</b>
F08		<b>FRP-96-729</b>
F16		<b>FRP-95-160</b>
F18		<b>FRP-96-639</b>
F26		<b>FRP-95-115</b>
F28		<b>FRP-96-653</b>
F30		<b>FRP-95-209</b>
F35		<b>FRP-95-505</b>
F42		<b>FRP-95-566</b>



Pneumatic  
Accessories

### Coalescing Filter Elements

Used On	Description	Part #
M16, M26, M30	type B element (0.5 micron)	<b>MSP-95-989</b>
M16	type C element (0.01 micron)	<b>MTP-95-548</b>
M26	type C element (0.01 micron)	<b>MTP-95-549</b>
M30	type C element (0.01 micron)	<b>MTP-95-551</b>
M35	type C element (0.01 micron)	<b>MTP-95-502</b>



MTP-95-548

### Desiccant Dryer Gel Refill

Used On	Description	Part #
X03	8 bags of silica gel refill	<b>DRP-85-059</b>



### Filter Bowls with Drain

Used On	Description	Part #
F08	plastic bowl with guard and manual drain	<b>GRP-96-712</b>
F16, M16	plastic bowl and metal bowl guard with flex tip drain	<b>FRP-95-014</b>
	plastic bowl and metal bowl guard with auto drain	<b>FRP-95-015</b>
	plastic bowl with manual drain	<b>FRP-95-017</b>
	metal bowl with sight glass and manual drain	<b>GRP-95-133</b>
	metal bowl with auto drain	<b>FRP-95-950</b>
F18	plastic bowl and bowl guard with manual drain	<b>GRP-96-634</b>
	plastic bowl and bowl guard with auto drain	<b>GRP-96-635</b>
	metal bowl with sight glass and manual drain	<b>GRP-96-636</b>
F26, M26	plastic bowl and metal bowl guard with flex tip drain	<b>GRP-95-935</b>
	plastic bowl and metal bowl guard with auto drain	<b>GRP-95-948</b>
	metal bowl with sight glass and manual drain	<b>GRP-95-931</b>
	metal bowl with auto drain	<b>GRP-95-960</b>
F28	plastic bowl, bowl guard, manual drain	<b>GRP-96-642</b>
	metal bowl, with sight glass, manual drain	<b>GRP-96-644</b>
F30, M30	plastic bowl and metal bowl guard with manual drain	<b>FRP-95-832</b>
	plastic bowl and metal bowl guard with auto drain	<b>FRP-95-775</b>
	plastic bowl with flex tip drain	<b>FRP-96-315</b>
	metal bowl with sight glass and manual drain	<b>GRP-95-676</b>
	metal bowl with auto drain	<b>GRP-95-970</b>



FRP-95-015

## Filter Drains



GRP-96-001

Used On	Description	Part #
F16, F18, F26, F28, F30, F35, M16, M26, M30, M32, M35	automatic drain with flourocarbon seal	<b>GRP-95-981</b>
F16, F18, F26, F28, F30, M16, M26, M30	automatic float drain with a nitrile seal	<b>GRP-95-973</b>
F16, F18, F26, F28, F30, F35, M16, M26, M30, M35	manual override drain	<b>GRP-96-001</b>
F16, F26, F30, M16, M26, M30	manual petcock drain for use with metal bowl units	<b>GRP-95-182</b>
F16, F26, F30, M16, M26, M30	manual flex tip drain	<b>FRP-95-610</b>
F18, F28	manual drain	<b>GRP-96-685</b>

## Sight Glass Kit



Used On	Description	Part #
M16, M26	sight glass kit for metal bowls	<b>GRP-95-079</b>

## Differential Pressure Indicators

## Features:

- used to replace damaged indicators on filters and modular coalescing filters
- pressure loss changes color of indicator window from green to red



DP2-01-000

Used On	Description	Part #
M16, M26, M30, M32	indicator	<b>DP2-01-000</b>
F35, M35	indicator	<b>DP2-01-001</b>

## Regulator Spring



Used On	Description	Part #
R16	0-50 PSI spring	<b>RRP-95-222</b>

## Regulator Flush Mounted Gauge



## Application:

- for units originally purchased with a flush mounted gauge

Used On	Description	Part #
R08	0-160 PSI	<b>GRP-96-719</b>

## Ring Style Tamper Resistant Kits



RPA-95-006

Used On	Description	Part #
R08	ring style tamper resistant kit	<b>RPA-96-735</b>
R16,R26		<b>RPA-95-006</b>
R18		<b>RRP-96-671</b>
R28		<b>RRP-96-672</b>

## Regulator Repair Kits

Used On	Description	Part #
R16	self-relieving repair kit	<b>RRP-95-131</b>
R18	relieving diaphragm assembly	<b>RRP-96-656</b>
R26	self-relieving repair kit	<b>RRP-95-952</b>
R28	relieving diaphragm assembly	<b>RRP-96-986</b>
R30	valve assembly: valve, spring, bottom plug O-ring	<b>RRP-95-159</b>
R40	valve assembly: valve, spring, retaining ring O-ring	<b>RRP-95-161</b>



RRP-95-952

Pneumatic  
Accessories

## Lubricator Bowls and Bowl Guards

Used On	Description	Part #
L08	plastic bowl with guard and manual drain	<b>LRP-96-736</b>
L16	metal bowl with sight glass and manual drain	<b>GRP-95-133</b>
	plastic bowl with guard and manual drain	<b>GRP-95-019</b>
	plastic bowl with no drain	<b>LRP-96-937</b>
L18	metal bowl with sight glass, manual drain	<b>GRP-96-636</b>
	plastic bowl with guard and manual drain	<b>LRP-96-701</b>
L26	metal bowl with sight glass and manual drain	<b>GRP-95-931</b>
	plastic bowl with no drain	<b>LRP-96-938</b>
L28	metal bowl with sight glass, manual drain	<b>GRP-96-644</b>
	plastic bowl with guard and manual drain	<b>LRP-96-702</b>
L30, L40	metal bowl with sight glass and manual drain	<b>GRP-95-676</b>
L30, L40, L50	plastic bowl with no drain	<b>LRP-96-940</b>



GRP-95-019

## Sight Domes and Fill Plugs

Used On	Description	Part #
L08, L16, L26	sight dome kit: dome and O-ring	<b>LRP-95-239</b>
L08	fill plug kit: fill plug and O-ring	<b>LRP-96-730</b>
L16, L26, L30	fill plug kit: fill plug and O-ring	<b>LRP-95-253</b>
L18, L28	sight dome assembly (new style)	<b>LRP-96-310</b>
L30, L40, L50	sight dome kit: dome and O-ring	<b>LRP-95-249</b>
L40, L50	fill plug kit: fill plug and O-ring	<b>LRP-95-250</b>



LRP-95-249

## Modular Shut-Off Valves

### Application:

- Useful for isolating and depressurizing a downstream unit requiring maintenance or replacement.

### Features:

- can be installed immediately upstream of a single unit or combination of units
- secure to the unit with a modular sleeve or modular sleeve wall mounting bracket
- ball-type valve operates with a 1/4 turn from open to shut position
- can be locked in the open position
- left to right flow



GPA-95-098

Used On	Description	Part #
F16, F26, R16, B26, L16, L26	¼" NPT safety shut-off valve	<b>GPA-95-096</b>
	⅜" NPT safety shut-off valve	<b>GPA-95-097</b>
	½" NPT safety shut-off valve	<b>GPA-95-098</b>

## Modular Blocks



GPA-95-919



GPA-95-223



GPA-96-610

**Features:**

## Manifold Block

- flexible installation can be installed after the filter or regulator, providing three additional ¼" NPT tapped auxiliary ports
- ½" inlet/outlet ports non-tapped
- 1-17/32" width

## End Block

- When used with the modular sleeve, end blocks allow a single unit or a combination of units to be piped into the air system in the modular mode.
- allows ease of unit servicing or replacement without disturbing the air line connections

Used On	Description	Part #
F16, M16, F26, M26, R16, R26, L16, L26	manifold block, three ¼" NPT auxiliary ports	<b>GPA-95-919</b>
	end block, ¼" NPT	<b>GPA-95-223</b>
	end block, ⅜" NPT	<b>GPA-95-224</b>
	end block, ½" NPT	<b>GPA-95-225</b>
F18, F28, R18, R28, L18, L28	end block, ¼" NPT	<b>GPA-96-610</b>
	end block, ⅜" NPT	<b>GPA-96-611</b>
	end block, ½" NPT	<b>GPA-96-612</b>
	end block, ¾" NPT	<b>GPA-96-613</b>

**Features:** Modular Pipe Adapters

- When used with the modular sleeve, adapter inserts allow a single unit or a combination of units to be piped into the air system in the modular mode.
- allows ease of unit servicing or replacement without disturbing the air line connections
- set includes 2 blocks

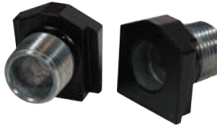

GPA-95-037

Used On	Description	Part #
F16, M16, F26, M26, R16, R26, L16, L26	¼" NPT	<b>GPA-95-035</b>
	⅜" NPT	<b>GPA-95-036</b>
	½" NPT	<b>GPA-95-037</b>

## Modular Sleeve

**Features:**

- design easily and quickly connects one or more units and accessories together without pipe nipples
- hand tightening the threaded pin provides a tight seal between the units



Used On	Description	Part #
F16, F26, R16, R26, L16, L26	modular sleeve	<b>GPA-95-292</b>

## Modular Sleeve with T Bracket

**Features:**

- designed to mount a single unit or combination of units directly to the wall
- sleeve and mounting bracket can be ordered assembled, or just the mounting bracket alone for use on existing modular sleeves



GPA-95-969

Used On	Description	Part #
F16, F26, R16, R26, L16, L26	bracket sleeve and bracket	<b>GPA-95-968</b> <b>GPA-95-969</b>

## Mounting Brackets and Joiner Sets

Used On Filter/ Regulator/ Lubricator Series	Description	Part #
RB3	mounting bracket (type L) and nut	<b>GRP-95-747</b>
F03	mounting bracket	<b>PS417B</b>
F08	mounting bracket (type T) with joiner set and port O-ring	<b>GPA-96-737</b>
	mounting bracket (type C)	<b>GPA-97-010</b>
	joiner set and port O-ring	<b>GPA-96-738</b>
R08	mounting bracket (type L)	<b>GRP-96-739</b>
F16, M16	mounting bracket (type L)	<b>GPA-95-016</b>
R16	mounting bracket (type L) and nut	<b>GPA-95-011</b>
R16, R21, R26, R30, R40	wall mount bracket with 1/4" NPT gauge port adapter	<b>RRP-95-590</b>
F18	mounting bracket (type C)	<b>GPA-96-604</b>
	mounting bracket (type L)	<b>GPA-96-606</b>
F18, F28	mounting bracket (type T)	<b>GPA-96-602</b>
	mounting bracket (type T) with joiner set and port O-ring	<b>GPA-96-603</b>
F26, M26	mounting bracket (type L)	<b>GPA-95-946</b>
R26	mounting bracket (type C) and nut	<b>RPA-95-947</b>
F28	mounting bracket (type C)	<b>GPA-96-605</b>
	mounting bracket (type L)	<b>GPA-96-607</b>
F30	wall mount, U-bolt pipe clamp	<b>GRP-95-734</b>

Pneumatic Accessories



## FRL Display

Increase your sales with this heavy duty, point-of-purchase Dixon® FRL Display. Display is designed to highlight the features and benefits of a modular Filter-Regulator-Lubricator Combination Unit for air line services. The display is perfect for a "Will Call" or showroom sales area.

**Features:**

- FRL combination unit with standard metal bowl with sight glass and manual drain
- modular mounting clamps
- pipe adapters
- display stand
- assembly is required



Part #
<b>WILK26DISPLAY</b>

Note: this product will be discontinued once stock is depleted.



## FRL Display

Increase your sales with this heavy duty, point-of-purchase Dixon® FRL Display. Display is designed to highlight the features and benefits of a modular Filter-Regulator-Lubricator Combination Unit for air line services. The display is perfect for your "Will Call" or showroom sales area.

**Features:**

- 74 Series basic combination unit with metal bowl with sight glass and manual drain
- modular mounting clamps
- pipe adapters
- display stand
- assembly is required

Part #

**NORG74DISPLAY**

Note: this product will be discontinued once stock is depleted.

Series I line of miniature filters, filter/regulators, regulators and lubricators in prepackaged clear plastic units are suitable for hanging on store peg racks or displays. The primary features of each unit are printed on the packaging. Each package contains 1 unit and an instruction sheet.

## F07 Carded Miniature Filters

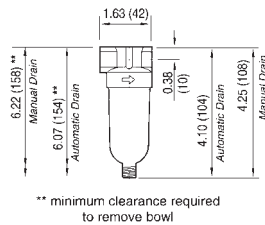

**Features:**

- 5 micron element
- 1 oz. reservoir
- inlet pressure **150 PSI** maximum
- maximum temperature: **125°F (52°C)**
- transparent bowl

Port Size	Flow (SCFM)	Automatic Drain Part #	Manual Drain Part #
1/4"	24	<b>F07-200AC</b>	<b>F07-200MC</b>

## R07 Carded Miniature Regulator

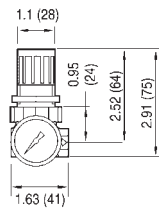

**Features:**

- pressure range 5-100 PSI
- relieving type
- inlet pressure **250 PSI** maximum
- maximum temperature: **150°F (66°C)**
- supplied with a GC620 gauge

Port Size	Flow (SCFM)	with Gauge Part #
1/4"	15	<b>R07-200RGC</b>

## L07 Carded Miniature Lubricator

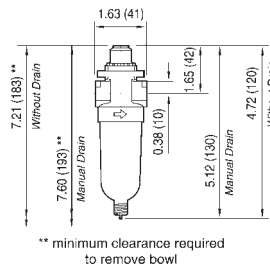

**Features:**

- 1 oz. reservoir
- inlet pressure **150 PSI** maximum
- maximum temperature: **125°F (52°C)**

Port Size	Flow (SCFM)	with Transparent Bowl Part #
1/4"	15	<b>L07-200AC</b>

**!** FRL's are designed for air service only, unless otherwise indicated.

SCFM ratings given at 100 PSIG inlet pressure for regulators, 90 PSIG all others.



## B07 Carded Miniature Filter/Regulators

**Features:**

- pressure range 5-100 PSI
- relieving type
- 5 micron element
- 1 oz. reservoir
- push to lock adjusting knob
- inlet pressure **150 PSI** maximum
- maximum temperature: **125°F (52°C)**
- supplied with a GC620 gauge
- bowl guard not available
- transparent bowl

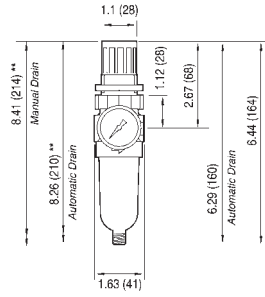

Pneumatic  
Accessories

Port Size	Flow (SCFM)	Automatic Drain Part #	Manual Drain Part #
1/4"	14	<b>B07-202AGC</b>	<b>B07-202MGC</b>

\*\* minimum clearance required to remove bowl

SCFM ratings given at 150 PSIG inlet pressure.

## F07 Miniature Filters

- 5 micron element
- 1 oz. reservoir
- inlet pressure **150 PSI** maximum
- maximum temperature: **125°F (52°C)**
- transparent bowl

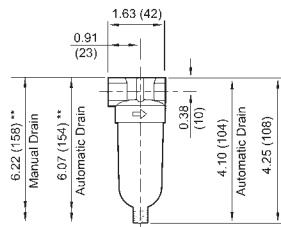

Port Size	Flow (SCFM)	Automatic Drain Part #	Manual Drain Part #
1/8"	19	<b>F07-100A</b>	<b>F07-100M</b>
1/4"	24	<b>F07-200A</b>	<b>F07-200M</b>

\*\* minimum clearance to remove bowl

SCFM ratings given at 90 PSIG inlet pressure.

## R07 Miniature Regulators

- pressure range 5-100 PSI
- relieving type
- inlet pressure **300 PSI** max.
- maximum temperature: **150°F (66°C)**
- regulation at flows up to 22 SCFM at 100 PSIG
- RG models supplied with a GC620 gauge
- panel nut not included

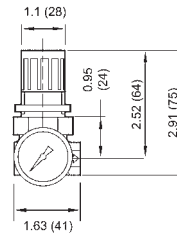

Port Size	Flow (SCFM)	with Gauge Part #	without Gauge Part #
1/8"	14	<b>R07-100RG</b>	<b>R07-100R</b>
1/4"	15	<b>R07-200RG</b>	<b>R07-200R</b>

SCFM ratings given at 100 PSIG inlet pressure.

## B07 Miniature Filter / Regulators

- pressure range 5-100 PSI
- relieving type
- 5 micron element
- 1 oz. reservoir
- push to lock adjusting knob
- inlet pressure **150 PSI** maximum
- maximum temperature: **125°F (52°C)**
- supplied with a GC620 gauge
- bowl guard not available
- transparent bowl

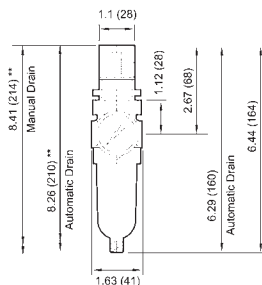

Port Size	Flow (SCFM)	Automatic Drain Part #	Manual Drain Part #
1/8"	13	<b>B07-102AG</b>	<b>B07-102MG</b>
1/4"	24	<b>B07-202AG</b>	<b>B07-202MG</b>

\*\* minimum clearance to remove bowl

SCFM ratings given at 150 PSIG inlet pressure.

### L07 Miniature Lubricators



- 1 oz. reservoir
- inlet pressure **150 PSI** maximum
- maximum temperature: **125°F (52°C)**

Port Size	Flow (SCFM)	Transparent Bowl Part #
1/8"	10	<b>L07-100A</b>
1/4"	14	<b>L07-200A</b>

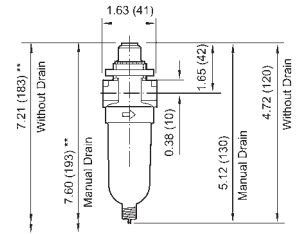

\*\* minimum clearance to remove bowl

### P1A Miniature Combination Units



- pressure range 5-125 PSI
- 1 oz. reservoir
- supplied with a GC620 gauge
- inlet pressure **150 PSI** maximum
- maximum temperature: **125°F (52°C)**
- transparent bowl

Port Size	Flow (SCFM)	Automatic Drain Part #	Manual Drain Part #
1/8"	10	<b>P1A-100A</b>	<b>P1A-100M</b>
1/4"	14	<b>P1A-200A</b>	<b>P1A-200M</b>

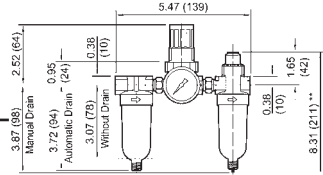

\*\* minimum clearance to remove bowl

### PTH Miniature Combination Units



- pressure range 5-125 PSI
- requires only 2 pipe connections
- inlet pressure **150 PSI** maximum
- maximum temperature: **125°F (52°C)**
- transparent bowl

Port Size	Flow (SCFM)	Automatic Drain Part #
1/8"	10	<b>PTH-100AG</b>
1/4"	14	<b>PTH-200AG</b>

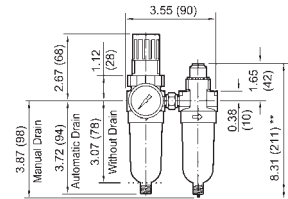

\*\* minimum clearance to remove bowl

### F72 Sub-Compact Airline Filters

**Features:**

- particle removal per ISO 8573-1, Class 5 and Class 3
- 40 micron element
- 2 oz. reservoir
- quick-release bayonet bowl
- prismatic lens liquid level indicator
- inlet pressure:
  - transparent bowl: **150 PSI** and **125°F (52°C)**
  - metal bowl: **250 PSI** and **150°F (66°)**

**Transparent Bowl**

Port Size	Flow (SCFM)	Semi-Automatic Drain Part #	Manual Drain Part #
1/4"	55	<b>F72G-2A</b>	<b>F72G-2M</b>

**Metal Bowl and Sight Glass**

Port Size	Flow (SCFM)	Semi-Automatic Drain Part #	Manual Drain Part #
1/4"	55	<b>F72G-2A-MB</b>	<b>F72G-2M-MB</b>

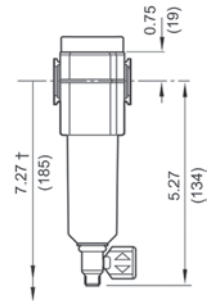

† Minimum clearance to remove bowl

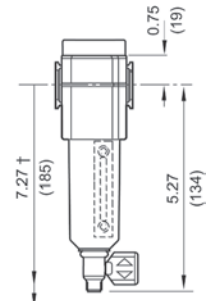

† Minimum clearance to remove bowl

with transparent bowl



with metal bowl

**!** FRL's are designed for air service only, unless otherwise indicated.

SCFM ratings at 100 PSIG inlet pressure for regulators, 90 PSIG all others.

## F73 Compact Airline Filters

**Features:**

- particle removal per ISO 8573-1, Class 5 and Class 3
- 40 micron element
- 4 oz. reservoir
- quick-release bayonet bowl
- prismatic lens liquid level indicator
- inlet pressure:
  - transparent bowl: **150 PSI** and **125°F (52°C)**
  - metal bowl: **250 PSI** and **175°F (79°C)**

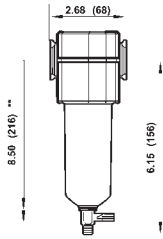

\*\* Minimum clearance required to remove bowl.

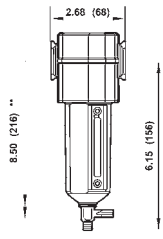

\*\* Minimum clearance required to remove bowl.

**Transparent Bowl**

Port Size	Flow (SCFM)	Automatic Drain Part #	Manual Drain Part #
1/4"	53	<b>F73G-2A</b>	<b>F73G-2M</b>
3/8"	65	<b>F73G-3A</b>	<b>F73G-3M</b>
1/2"	69	<b>F73G-4A</b>	<b>F73G-4M</b>

**Metal Bowl and Sight Glass**

Port Size	Flow (SCFM)	Automatic Drain Part #	Manual Drain Part #
1/4"	53	<b>F73G-2A-MB</b>	<b>F73G-2M-MB</b>
3/8"	65	<b>F73G-3A-MB</b>	<b>F73G-3M-MB</b>
1/2"	69	<b>F73G-4A-MB</b>	<b>F73G-4M-MB</b>



with transparent bowl



with metal bowl

Pneumatic Accessories

## F74 Standard Airline Filters

**Features:**

- particle removal per ISO 8573-1, Class 5 and Class 3
- 40 micron element
- 7 oz. reservoir
- quick-release bayonet bowl
- prismatic lens liquid level indicator
- inlet pressure:
  - transparent bowl: **150 PSI** and **125°F (52°C)**
  - metal bowl: **250 PSI** and **175°F (79°C)**

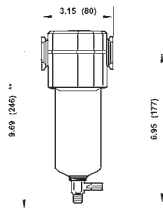

\*\* Minimum clearance required to remove bowl.

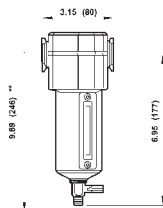

\*\* Minimum clearance required to remove bowl.

**Transparent Bowl and Guard**

Port Size	Flow (SCFM)	Automatic Drain Part #	Manual Drain Part #
3/8"	112	<b>F74G-3A</b>	<b>F74G-3M</b>
1/2"	140	<b>F74G-4A</b>	<b>F74G-4M</b>
3/4"	140	<b>F74G-6A</b>	<b>F74G-6M</b>

**Metal Bowl and Sight Glass**

Port Size	Flow (SCFM)	Automatic Drain Part #	Manual Drain Part #
3/8"	112	<b>F74G-3A-MB</b>	<b>F74G-3M-MB</b>
1/2"	140	<b>F74G-4A-MB</b>	<b>F74G-4M-MB</b>
3/4"	140	<b>F74G-6A-MB</b>	<b>F74G-6M-MB</b>



with transparent bowl



with metal bowl

See pages 422 to 427 for accessories.

FRL's are designed for air service only, unless otherwise indicated.

SCFM ratings at 90 PSIG inlet pressure.

### F17 Jumbo Airline Filters

**Features:**

- general purpose with low pressure drop and excellent water removal characteristics
- 40 micron element
- 1 qt. reservoir
- inlet pressure: **250 PSI** and **175°F (79°C)**



**Metal Bowl and Sight Glass**

Port Size	Flow (SCFM)	Automatic Drain Part #	Manual Drain Part #
3/4"	325	<b>F17-600A</b>	<b>F17-600M</b>
1"	425	<b>F17-800A</b>	<b>F17-800M</b>
1 1/4"	425	<b>F17-A00A</b>	<b>F17-A00M</b>
1 1/2"	425	<b>F17-B00A</b>	<b>F17-B00M</b>

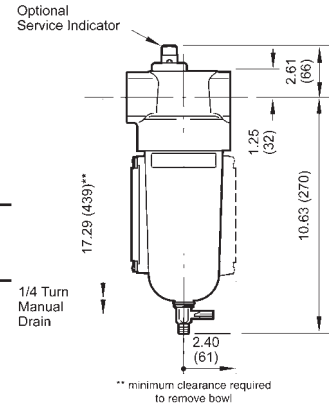

**Features:**

- 40 micron element
- quick-release bayonet bowl
- prismatic lens liquid level indicator
- 7 oz. reservoir
- inlet pressure: **250 PSI** and **175°F (79°C)**



**Metal Bowl and Sight Glass**

Port Size	Flow (SCFM)	Automatic Drain Part #	Manual Drain Part #
2"	1400	<b>F18-C00A</b>	<b>F18-C00M</b>

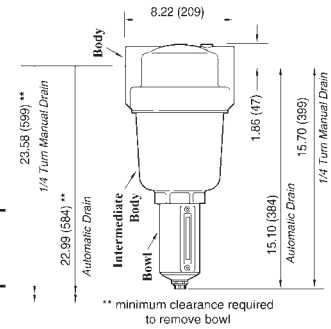

### F74 Oil Removal Filters

**Features:**

- provides air quality class 2 hydrocarbon and class 1 particulate removal per ISO 8573-1
- element removes particles down to 0.01mm. Maximum remaining oil content of air leaving the filter is 0.01 ppm at **70°F (21°C)** with an inlet concentration of 8 ppm
- For maximum service life install a general purpose filter upstream of the oil removal filter.
- service life indicator turns from green to red when element needs to be replaced
- in-line or modular installation
- quick-release bayonet bowl
- prismatic lens liquid level indicator
- inlet pressure: **250 PSI** and **150°F (66°C)**



Port Size	Flow (SCFM) Saturated	SCFM Dry	Automatic Drain Part #
3/8"	35	70	<b>F74C-3A-MB</b>
1/2"	35	75	<b>F74C-4A-MB</b>
1/2"	60	100	<b>F74H-4A-MB</b>
3/4"	60	120	<b>F74H-6A-MB</b>

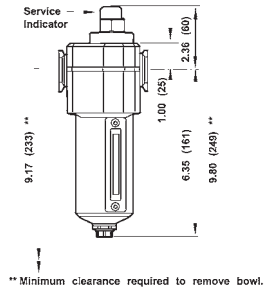

See pages 422 to 427 for accessories.

**!** FRL's are designed for air service only, unless otherwise indicated.

SCFM ratings at 90 PSIG inlet pressure.

F74 **Oil Vapor Removal Filters****Features:**

- provides air quality class 1 particulate removal per ISO 8573-1, when used with the F74C series
- Filter and element designs optimizes air velocity and contact time to reduce oil content of air leaving the filter to 0.003 ppm at **70°F (21°C)**.
- For maximum service life install a general purpose filter and an oil removal filter upstream of the oil vapor removal filter.
- Minimum service life of 400 hours can be expected if the vapor removal filter is protected upstream by an oil removal (coalescing) filter and if the filtration temperature is in the region of **70° to 80°F (21° to 26°C)**. Above this range, oil vapor content of compressed air increases substantially and element service life is reduced.
- Carbon cartridge element provides long service life.
- Activated carbon cartridge filter element absorbs oil vapors and removes most hydrocarbon odors.
- in-line or modular installation
- quick-release bayonet bowl
- inlet pressure: **250 PSI and 150°F (66°C)**
- metal bowl

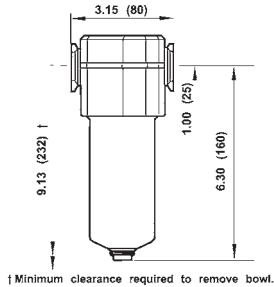

Port Size	Flow (SCFM)	Automatic Drain with Metal Bowl Part #
3/8"	21	<b>F74V-3A-MB</b>
1/2"	21	<b>F74V-4A-MB</b>

SCFM ratings at 90 PSIG inlet pressure.

## R72 Sub-Compact Regulators

**Features:**

- pressure range 5-150 PSI
- inlet pressure: **300 PSI**
- maximum temperature: **150°F (66°C)**
- in-line or modular installation
- two full flow 1/8" NPT gauge ports
- RG models supplied with GC620 gauge
- To order 0-60 PSI range consult Dixon®.

Port Size	Flow (SCFM)	with Gauge Part #	without Gauge Part #
1/4"	70	<b>R72G-2RG</b>	<b>R72G-2R</b>
3/8"	70	<b>R72G-3RG</b>	<b>R72G-3R</b>

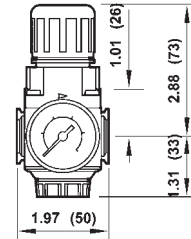

## R73 Compact Regulators

**Features:**

- pressure range 5-150 PSI
- inlet pressure: **300 PSI**
- maximum temperature: **150°F (66°C)**
- in-line or modular installation
- relieving type
- two full flow 1/4" NPT gauge ports
- RG models supplied with GC230 gauge
- To order 0-60 PSI range consult Dixon®.

Port Size	Flow (SCFM)	with Gauge Part #	without Gauge Part #
1/4"	91	<b>R73G-2RG</b>	<b>R73G-2R</b>
3/8"	144	<b>R73G-3RG</b>	<b>R73G-3R</b>
1/2"	144	<b>R73G-4RG</b>	<b>R73G-4R</b>

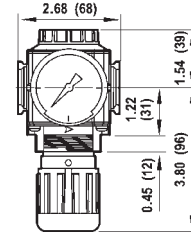

SCFM ratings given at 150 PSIG inlet pressure

See pages 422 to 427 for accessories.



FRL's are designed for air service only, unless otherwise indicated.

## R74 Standard Regulators

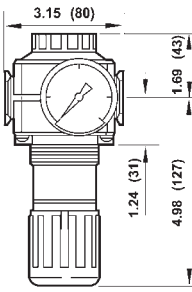

**Features:**

- pressure range 5-150 PSI
- inlet pressure: **300 PSI**
- maximum temperature: **150°F (66°C)**
- relieving type
- two full flow 1/4" NPT gauge ports
- RG models supplied with GC230 gauge
- To order 0-60 PSI range consult Dixon®.
- in-line or modular installation

Port Size	Flow (SCFM)	with Gauge Part #	without Gauge Part #
3/8"	208	<b>R74G-3RG</b>	<b>R74G-3R</b>
1/2"	220	<b>R74G-4RG</b>	<b>R74G-4R</b>
3/4"	220	<b>R74G-6RG</b>	<b>R74G-6R</b>



Pneumatic Accessories

## R17, R18 Jumbo Regulators

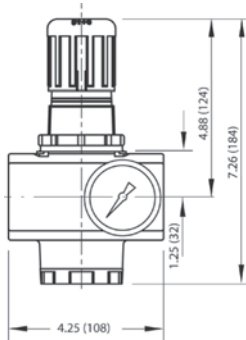

**Features:**

- pressure range 5-125 PSI
- inlet pressure: **300 PSI**
- maximum temperature: **175°F (79°C)**
- in-line or modular installation
- relieving type
- two full-flow 1/4" NPT gauge ports
- RG models supplied with GC230 gauge

Port Size	Flow (SCFM)	with Gauge Part #	without Gauge Part #
3/4"	440	<b>R17-600RG</b>	<b>R17-600R</b>
1"	480	<b>R17-800RG</b>	<b>R17-800R</b>
1 1/4"	400	<b>R17-A00RG</b>	<b>R17-A00R</b>
1 1/2"	440	<b>R17-B00RG</b>	<b>R17-B00R</b>

SCFM ratings given at 150 PSIG inlet pressure

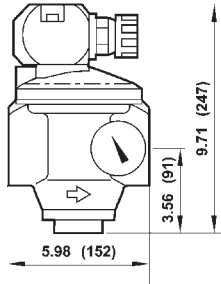

**Features:**

- 5-125 PSI range
- inlet pressure: **450 PSI**
- maximum temperature: **175°F (79°C)**
- relieving type
- two full flow 1/4" NPT gauge ports
- RG model supplied with GC230 gauge

Port Size	Flow (SCFM)	with Gauge Part #	without Gauge Part #
2"	2000	<b>R18-C05RG</b>	<b>R18-C05R</b>

SCFM ratings given at 100 PSIG inlet pressure



## R11 General T-Handle Regulators

Floating valve pin provides positive seating and dependability. Large diaphragm provides quick response to flow demands and line pressure changes. Balanced valve reduces inlet pressure variations on outlet pressure.

**Features:**

- pressure range 5-125 PSI
- inlet pressure: **400 PSI**
- maximum temperature: **175°F (79°)**
- T-handle adjustment
- supplied with GC620 gauge

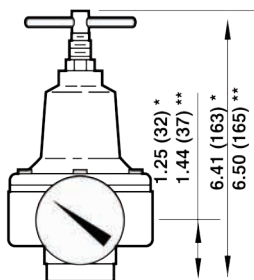

Port Size	Flow (SCFM)	with Gauge Part #
1/4"	110	<b>R11-013RG</b>
3/8"	110	<b>R11-037RG</b>
1/2"	260	<b>R11-061RG</b>

SCFM ratings at 150 PSIG.



See pages 422 to 427 for accessories.

FRL's are designed for air service only, unless otherwise indicated.



## R72 Manifold Regulators

Manifold up to six regulators on a single air supply. Design allows in-line installation with hex nipple or modular installation with 72 Series accessories.

### Features:

- pressure range 5-150 PSI
- inlet pressure: **300 PSI**
- maximum temperature: **150°F (66°C)**
- RG models supplied with GC620 gauge

Port Size	Flow (SCFM)	with Gauge Part #	without Gauge Part #
¼"	83	<b>R72M-2RG</b>	<b>R72M-2R</b>
⅜"	83	<b>R72M-3RG</b>	<b>R72M-3R</b>

SCFM ratings at 150 PSIG.

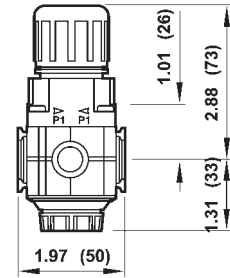

## R83 Cylinder Gas Regulator



### Applications:

UL listed for service with Carbon Dioxide, water, pumped air, Nitrogen, Argon, Helium, Krypton, Neon and Xenon.  
*Not to be used with flammable gases.*

### Features:

- pressure range 5-125 PSI
- inlet pressure: **3000 PSI**
- maximum temperature: **140°F (60°C)**
- relieving type
- two ports for high pressure and two ports for service

Port Size	Flow (SCFM)	without Gauge Part #
¼"	10	<b>R83-200R</b>

SCFM ratings given at 1000 PSIG inlet pressure.

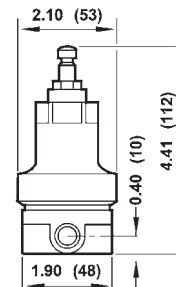

## R91 Miniature Water Regulator

### Application:

Designed for use with deionized water and potable water systems. Plastic and metal components in contact with fluid are approved by the National Sanitation Foundation (NSF) or meet Food and Drug Administration (FDA) recommendations for use in potable water systems.

### Features:

- inlet pressure: **150 PSI**
- maximum temperature: **125°F (52°C)**
- non-relieving type
- supplied with GC620 gauge
- food grade elastomers

Port Size	Flow (GPM)	with Gauge Part #
¼"	1.75	<b>R91-221RG</b>

Flow rating at 100 PSIG.

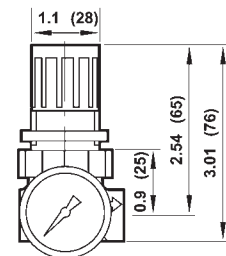

See pages 422 to 427 for accessories.

FRL's are designed for air service only, unless otherwise indicated.



## R43 Water Pressure Regulators

**Application:**

Used in water systems to reduce and maintain pressure at a nearly constant level despite changes in the inlet pressure and changes in downstream flow requirements.

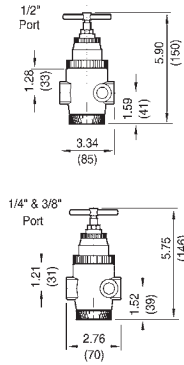

**Features:**

- pressure range 5-125 PSI
- inlet pressure: **400 PSI**
- T-handle adjustment
- brass body and aluminum bonnet
- non-relieving type
- gauge port is full-flow and can be used as an outlet port
- supplied with GC230 gauge
- temperature range:
  - water service: **35° to 200°F (2°C to 93°C)**
  - air service: **-30° to 200°F (-34°C to 93°C)**

Port Size	Flow (GPM)	with Gauge Part #
1/4"	5	<b>R43-201RG</b>
3/8"	5	<b>R43-301RG</b>
1/2"	10	<b>R43-406RG</b>



Pneumatic Accessories

## 11-009 Water Regulators

**Application:**

Balanced valve minimizes effects of the inlet pressure variations on outlet pressure.

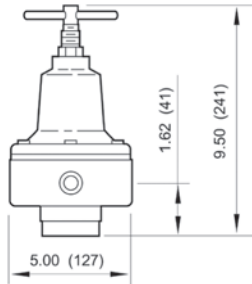

**Features:**

- inlet pressure: **400 PSI**
- T-handle adjustment
- non-relieving type
- body, valve and bottom plug are brass, bonnet is aluminum and steel
- elastomers are nitrile
- temperature range:
  - water service: **35° to 200°F (2° to 93°C)**
  - air service: **-30° to 200°F (-34° to 93°C)**

Port Size	Flow (GPM)	without Gauge Part #
3/4"	27.5	<b>11-009-065</b>
1"	27.5	<b>11-009-081</b>



## B72 Sub-Compact Filter / Regulators

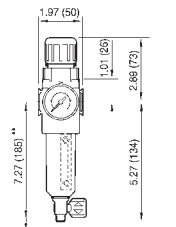

1/4 Turn Manual Drain  
\*\* minimum clearance required to remove bowl

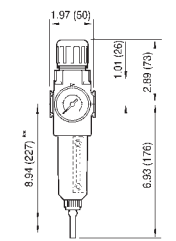

Semi auto Drain  
\*\* minimum clearance required to remove bowl

**Features:**

- particle removal per ISO 8573-1, Class 5 and Class 3
- pressure range 5-150 PSI
- in-line or modular installation
- 40 micron element
- 2 oz. reservoir
- quick-release bayonet bowl
- prismatic lens liquid level indicator
- supplied with GC620 gauge
- inlet pressure:
  - transparent bowl: **150 PSI and 125°F (52°C)**
  - metal bowl: **250 PSI and 150°F (66°C)**

**Transparent Bowl**

Port Size	Flow (SCFM)	Semi-Automatic Drain Part #	Manual Drain Part #
1/4"	80	<b>B72G-2AG</b>	<b>B72G-2MG</b>

**Metal Bowl and Sight Glass**

Port Size	Flow (SCFM)	Semi-Automatic Drain Part #	Manual Drain Part #
1/4"	80	<b>B72G-2AG-MB</b>	<b>B72G-2MG-MB</b>
3/8"		<b>B72G-3AG-MB</b>	<b>B72G-3MG-MB</b>



with transparent bowl



with metal bowl

See pages 422 to 427 for accessories.

FRL's are designed for air service only, unless otherwise indicated.

SCFM ratings given at 150 PSIG inlet pressure.

## B73 Compact Filters / Regulators



with transparent bowl



with metal bowl

**Features:**

- particle removal per ISO 8573-1, Class 5 and Class 3
- pressure range 5-150 PSI
- in-line or modular installation
- 40 micron element
- 3.5 oz. reservoir
- quick-release bayonet bowl
- prismatic lens liquid level indicator
- supplied with GC230 gauge
- inlet pressure:
  - transparent bowl: **150 PSI and 125°F (52°C)**
  - metal bowl: **250 PSI and 175°F (79°C)**

**Transparent Bowl**

Port Size	Flow (SCFM)	Automatic Drain Part #	Manual Drain Part #
1/4"	78	<b>B73G-2AG</b>	<b>B73G-2MG</b>
3/8"	123	<b>B73G-3AG</b>	<b>B73G-3MG</b>
1/2"	123	<b>B73G-4AG</b>	<b>B73G-4MG</b>

**Metal Bowl and Sight Glass**

Port Size	Flow (SCFM)	Automatic Drain Part #	Manual Drain Part #
1/4"	78	<b>B73G-2AG-MB</b>	<b>B73G-2MG-MB</b>
3/8"	123	<b>B73G-3AG-MB</b>	<b>B73G-3MG-MB</b>
1/2"	123	<b>B73G-4AG-MB</b>	<b>B73G-4MG-MB</b>

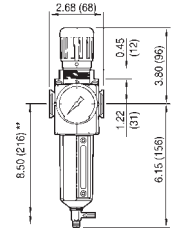
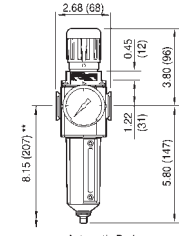
1/4 Turn Manual Drain  
\*\* minimum clearance required to remove bowlAutomatic Drain  
\*\* minimum clearance required to remove bowl

## B74 Standard Filters / Regulators



with guard



with metal bowl

**Features:**

- pressure range 5-150 PSI
- 40 micron element
- 7 oz. reservoir
- relieving type
- supplied with GC230 gauge
- inlet pressure:
  - transparent bowl: **5-150 PSI and 125°F (52°C)**
  - metal bowl: **5-150 PSI and 175°F (79°C)**

**Transparent Bowl and Guard**

Port Size	Flow (SCFM)	Automatic Drain Part #	Manual Drain Part #
1/2"	212	<b>B74G-4AG</b>	<b>B74G-4MG</b>
3/4"	212	<b>B74G-6AG</b>	<b>B74G-6MG</b>

**Metal Bowl and Sight Glass**

Port Size	Flow (SCFM)	Automatic Drain Part #	Manual Drain Part #
3/8"	163	<b>B74G-3AG-MB</b>	<b>B74G-3MG-MB</b>
1/2"	212	<b>B74G-4AG-MB</b>	<b>B74G-4MG-MB</b>
3/4"	212	<b>B74G-6AG-MB</b>	<b>B74G-6MG-MB</b>

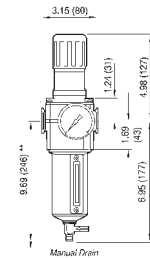
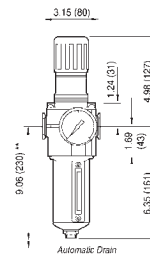
Manual Drain  
\*\* minimum clearance required to remove bowlAutomatic Drain  
\*\* minimum clearance required to remove bowl

See pages 422 to 427 for accessories.



FRL's are designed for air service only, unless otherwise indicated.

SCFM ratings given at 150 PSIG inlet pressure.

## L72 Sub-Compact Micro-Fog Lubricators

**Application:**

- Micro-fog lubricators, identified by a red adjusting screw, are used for applications containing one or more points of lubrication, cylinders and multiple or single tools.
- Air flow through the lubricator lifts oil from the reservoir to the sight-feed dome. Oil is dropped into the fog generator and atomized into a fine mist. Lightweight particles are delivered downstream for lubrication. Heavier particles fall back into the reservoir.
- The micro-fog lubricator delivers 10% of the oil drops visible through the transparent sight-feed dome.
- Micro-fog lubricators cannot be filled under pressure.

**Features:**

- 2 oz. reservoir
- in-line or modular installation
- quick release bayonet bowl
- micro-fog design delivers aerosol mist
- recommended lubricants: misting type oil rated 50 to 200 SSU (ISO Grade 7 to 46) at **100°F (38°C)**
- maximum operating conditions:
  - transparent bowl: **150 PSI and 125°F (52°C)**
  - metal bowl: **250 PSI and 175°F (79°C)**

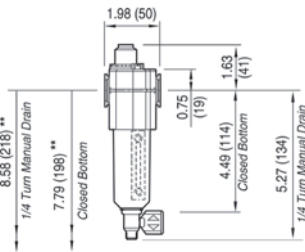

Port Size	Flow (SCFM)	Transparent Bowl Part #	Metal Bowl Part #
1/4"	51	<b>L72M-2</b>	<b>L72M-2MB</b>

SCFM ratings given at 90 PSIG inlet pressure.



with transparent bowl

## L73 Compact Micro-Fog Lubricators

**Features:**

- 4 oz. reservoir
- in-line or modular installation
- quick release bayonet bowl
- micro-fog design delivers aerosol mist
- recommended lubricants: misting type oil rated 50 to 200 SSU (ISO Grade 7 to 46) at **100°F (38°C)**
- maximum operating conditions:
  - transparent bowl: **150 PSI and 125°F (52°C)**
  - metal bowl: **250 PSI and 175°F (79°C)**

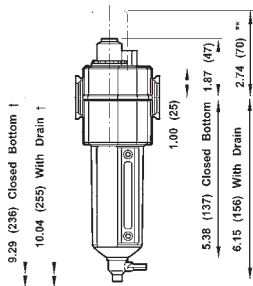

Port Size	Flow (SCFM)	Transparent Bowl Part #	Metal Bowl Part #
1/4"	70	<b>L73M-2</b>	<b>L73M-2MB</b>
3/8"	70	<b>L73M-3</b>	<b>L73M-3MB</b>
1/2"	70	<b>L73M-4</b>	<b>L73M-4MB</b>

SCFM ratings given at 90 PSIG inlet pressure.



with transparent bowl

See pages 422 to 427 for accessories.



FRL's are designed for air service only, unless otherwise indicated.

**Applications:**

- Micro-fog lubricators, identified by a red adjusting screw, are used for applications containing one or more points of lubrication, cylinders and multiple or single tools.
- Air flow through the lubricator lifts oil from the reservoir to the sight-feed dome. Oil is dropped into the fog generator and atomized into a fine mist. Lightweight particles are delivered downstream for lubrication. Heavier particles fall back into the reservoir.
- The micro-fog lubricator delivers 10% of the oil drops visible through the transparent sight-feed dome.



- *Micro-fog lubricators cannot be filled under pressure.*

### L74 Standard Micro-Fog Lubricators

**Features:**

- 7 oz. reservoir
- in-line or modular installation
- quick release bayonet bowl
- micro-fog design delivers aerosol mist
- recommended lubricants: misting type oil rated 50 to 200 SSU (ISO Grade 7 to 46) at **100°F (38°C)**
- maximum operating conditions:
  - transparent bowl: **150 PSI** and **125°F (52°C)**
  - metal bowl: **250 PSI** and **175°F (79°C)**



Port Size	Flow (SCFM)	Transparent Bowl Part #	Metal Bowl Part #
3/8"	114	<b>L74M-3</b>	<b>L74M-3MB</b>
1/2"	154	<b>L74M-4</b>	<b>L74M-4MB</b>
3/4"	142	<b>L74M-6</b>	<b>L74M-6MB</b>

SCFM ratings given at 90 PSIG inlet pressure.

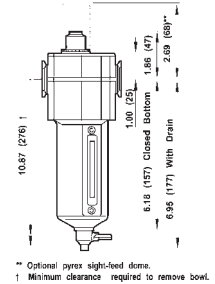

### L17 Jumbo Micro-Fog Lubricators

**Features:**

- 1 qt. reservoir
- oil level sight gauge
- one turn threaded bowl attachment permits easy maintenance
- inlet pressure: **250 PSI**
- maximum temperature: **175°F (79°C)**



Port Size	Flow (SCFM)	Metal Bowl with Sight Glass Part #
3/4"	160	<b>L17-600A</b>
1"	275	<b>L17-800A</b>
1 1/4"	275	<b>L17-A00A</b>
1 1/2"	275	<b>L17-B00A</b>

SCFM ratings given at 90 PSIG inlet pressure.

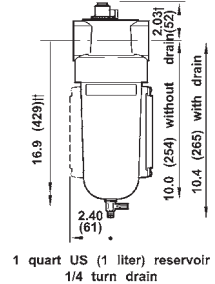

### 10-076 Jumbo General Purpose Oil-Fog Lubricators

**Features:**

- 2 gallon reservoir
- oil flow can be positively set
- reservoir is ASME constructed
- inlet pressure: **250 PSI**
- maximum temperature: **175°F (79°C)**
- oil level sight gauge



Port Size	Flow (SCFM)	Metal Bowl with Sight Glass Part #
2"	1000	<b>10-076-004</b>

See pages 422 to 427 for accessories.

See page 367 for air tool lubricant.

SCFM ratings given at 100 PSIG inlet pressure.

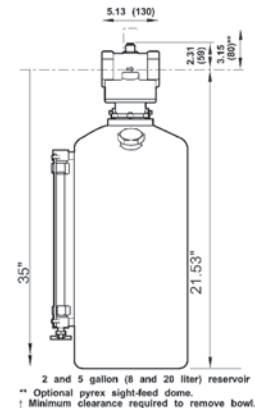

FRL's are designed for air service only, unless otherwise indicated.

## Micro-Fog Lubricator with Pyrex Sight Feed Dome

**Application:**

- Designed for use with alcohol or other anti-freeze agents when units are installed in cold temperature environments.
- Micro-fog lubricators are used for applications containing one or more points of lubrication, cylinders and multiple or single tools.
- Air flow through the lubricator lifts oil from the reservoir to the sight-feed dome. Oil is dropped into the fog generator and atomized into a fine mist. Lightweight particles are delivered downstream for lubrication. Heavier particles fall back into the reservoir.

**Features:**

- high pressure sight feed dome with aluminum case and fluorocarbon O-rings and seals; high pressure sight glass on bowls and metal petcock drain
- The micro-fog lubricator delivers 10% of the oil drops visible through the transparent sight-feed dome.
- *Micro-fog lubricators cannot be filled under pressure.*

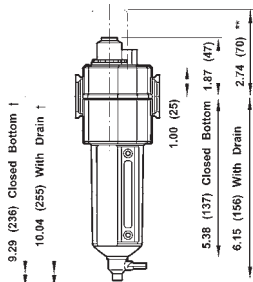

**Compact**

**Features:**

- 4 oz. reservoir
- in-line or modular installation
- quick release bayonet bowl
- micro-fog design delivers aerosol mist
- recommended lubricants: misting type oil rated 50 to 200 SSU (ISO Grade 7 to 46) at 100°F
- inlet pressure: **250 PSI**
- maximum temperature: **175°F (79°C)**

Port Size	Flow (SCFM)	Metal Bowl with Sight Glass Part #
3/8"	60	<b>L73M-3MBPX</b>
1/2"	60	<b>L73M-4MBPX</b>



**Standard**

**Features:**

- 7 oz. reservoir
- in-line or modular installation
- quick release bayonet bowl
- micro-fog design delivers aerosol mist
- recommended lubricants: misting type oil rated 50 to 200 SSU (ISO Grade 7 to 46) at 100°F
- inlet pressure: **250 PSI**
- maximum temperature: **175°F (79°C)**

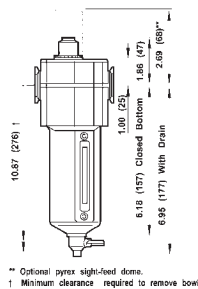

Port Size	Flow (SCFM)	Metal Bowl with Sight Glass Part #
3/8"	114	<b>L74M-3MBPX</b>
1/2"	154	<b>L74M-4MBPX</b>
3/4"	142	<b>L74M-6MBPX</b>



**Jumbo**

**Features:**

- 1 qt. reservoir
- oil level sight gauge
- particle removal per ISO 8573-1, class 5 and class 3
- one turn threaded bowl attachment permits easy maintenance
- inlet pressure: **250 PSI**
- maximum temperature: **175°F (79°C)**

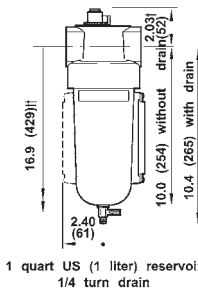

Port Size	Flow (SCFM)	Metal Bowl with Sight Glass Part #
1"	275	<b>L17-800APX</b>



See pages 422 to 427 for accessories.

See page 367 for air tool lubricant.



FRL's are designed for air service only, unless otherwise indicated.

SCFM ratings given at 90 PSIG inlet pressure.

## L74 Standard Oil-Fog Lubricators

**Applications:**

- Oil-fog lubricators, identified by a green adjusting screw, are used for lubricating a single air tool or air motor and should be installed as near the device as possible.

**Features:**

- all the oil visible dropping through the transparent sight-feed dome goes to the airstream
- L72C, L73C and L74C OIL-FOG lubricators can be filled under pressure
- in-line or modular installation
- quick release bayonet bowl
- can be filled under pressure
- recommended lubricants: misting type oil rated 50 to 200 SSU (ISO Grade 7 to 46) at 100°F
- maximum operating conditions:
  - transparent bowl: **150 PSI** and **125°F (52°C)**
  - metal bowl: **250 PSI** and **175°F (79°C)**
- 7 oz. reservoir



metal bowl

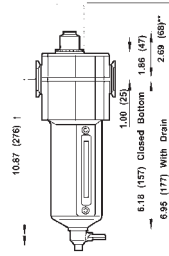

\*\* Optional pyrex sight-feed dome.  
† Minimum clearance required to remove bowl.

Port Size	Flow (SCFM)	Transparent Bowl Part #	Metal Bowl Part #
3/8"	118	<b>L74C-3</b>	<b>L74C-3MB</b>
1/2"	192	<b>L74C-4</b>	<b>L74C-4MB</b>
3/4"	186	<b>L74C-6</b>	<b>L74C-6MB</b>

## L17 Jumbo Oil-Fog Lubricators

**Application:**

- Oil-fog lubricators, identified by a green adjusting screw, are used for lubricating a single air tool or air motor and should be installed as close to the device as possible.

**Features:**

- 1 qt. reservoir
- oil level sight gauge
- All the oil visible dropping through the transparent sight-feed dome goes to the airstream.
- one turn threaded bowl attachment permits easy maintenance
- inlet pressure: **250 PSI**
- maximum temperature: **175°F(79°C)**



metal bowl

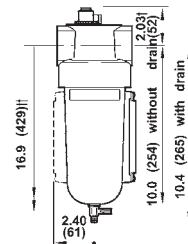

1 quart US (1 liter) reservoir  
1/4 turn drain

Port Size	Flow (SCFM)	Metal Bowl with Sight Glass Part #
3/4"	160	<b>L17-600D</b>
1"	275	<b>L17-800D</b>
1 1/2"	275	<b>L17-B00D</b>

See pages 422 to 427 for accessories.  
See page 367 for air tool lubricant.



FRL's are designed for air service only, unless otherwise indicated.

SCFM ratings given at 90 PSIG inlet pressure.

## E73 Compact Combination Units

**Features:**

- 5-150 PSI range
- 4 oz. reservoir
- inlet pressure:
  - transparent bowl: **150 PSI** and **125°F (52°C)**
  - metal bowl: **250 PSI** and **175°F (79°C)**
- supplied with a G230 gauge
- connected modularly
- Includes 2 clamps and wall mounting brackets # 4314-52, 2 clamps # 4314-51 and 2 NPT pipe adapters #4315-01.

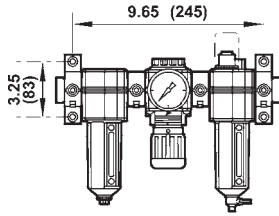

metal bowls

Pneumatic Accessories

### Transparent Bowl

Port Size	Flow (SCFM)	Automatic Drain Part #	Manual Drain Part #
1/4"	70	<b>E73-2A</b>	<b>E73-2M</b>
3/8"	70	<b>E73-3A</b>	<b>E73-3M</b>
1/2"	70	<b>E73-4A</b>	<b>E73-4M</b>

### Metal Bowl

Port Size	Flow (SCFM)	Automatic Drain Part #	Manual Drain Part #
3/8"	70	<b>E73-3A-MB</b>	<b>E73-3M-MB</b>
1/2"	70	<b>E73-4A-MB</b>	<b>E73-4M-MB</b>

## E74 Standard Combination Units

**Features:**

- pressure range 5-150 PSI
- 7 oz. reservoir
- inlet pressure:
  - transparent bowl: **150 PSI** and **125°F (52°C)**
  - metal bowl: **250 PSI** and **175°F (79°C)**
- models supplied with a GC230 gauge
- connected modularly
- Includes 2 clamps and wall mounting brackets # 4314-52, 2 clamps # 4314-51 and 2 NPT pipe adapters.

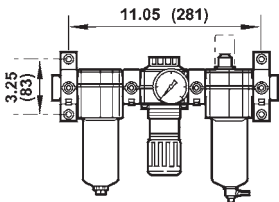

transparent bowl with guard

### Transparent Bowl and Guard

Port Size	Flow (SCFM)	Automatic Drain Part #	Manual Drain Part #
1/2"	150	<b>E74-4A</b>	<b>E74-4M</b>
3/4"	140	<b>E74-6A</b>	<b>E74-6M</b>

### Metal Bowl and Sight Glass

Port Size	Flow (SCFM)	Automatic Drain Part #	Manual Drain Part #
3/8"	110	<b>E74-3A-MB</b>	<b>E74-3M-MB</b>
1/2"	150	<b>E74-4A-MB</b>	<b>E74-4M-MB</b>
3/4"	140	<b>E74-6A-MB</b>	<b>E74-6M-MB</b>

## P8A Jumbo Combination Units

**Features:**

- pressure range 5-125 PSI
- 1 qt. reservoir
- inlet pressure: **250 PSI**
- maximum temperature: **175°F (79°C)**

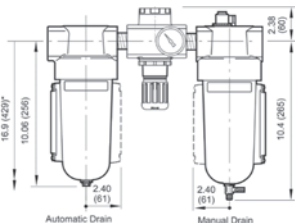

\* Minimum clearance required to remove bowl.



with metal bowls

### Metal Bowl and Sight Glass

Port Size	Flow (SCFM)	Automatic Drain Part #	Manual Drain Part #
1"	275	<b>P8A-860A</b>	<b>P8A-860M</b>

SCFM ratings given at 90 PSIG inlet pressure.



FRL's are designed for air service only, unless otherwise indicated.



## 17-016 Drip Leg Automatic Drain

### Application:

- Used in compressed air systems to automatically expel liquids from piping systems. Installed at low points in piping and at end of pipe network where water is likely to accumulate.

### Features:

- metal bowl
- drain is ported to 1/8" NPT
- inlet pressure: **250 PSIG**
- maximum temperature: **175°F (79°C)**

Port Size	Part #
1/2"	<b>17-016-107</b>

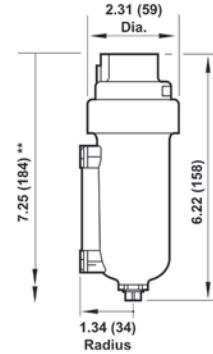

\*\* Minimum clearance to remove bowl.

## Filter Elements



5 micron element  
5925-03

Used On	Description	Part #
F07	5 micron	<b>3652-11</b>
F08	5 micron 40 micron	<b>3161-16</b> <b>3161-18</b>
F17	5 micron bronze 25 micron bronze 40 micron bronze	<b>5311-01</b> <b>5311-02</b> <b>5311-03</b>
F18	5 micron bronze 25 micron bronze 50 micron bronze	<b>5882-11</b> <b>5882-12</b> <b>5882-13</b>
F72	5 micron 40 micron	<b>5925-03</b> <b>5925-02</b>
F73	5 micron 40 micron	<b>4438-01</b> <b>4438-03</b>
F74	5 micron 40 micron	<b>4338-04</b> <b>4338-05</b>

## Filter Bowl / Bowl Guards



transparent bowl and guard  
4325-51R

Used On	Description	Part #
F07	polycarbonate bowl with auto drain polycarbonate bowl with manual drain	<b>3646-51</b> <b>3646-53</b>
F08	transparent bowl with manual drain	<b>3776-50</b>
F17	metal bowl with petcock drain	<b>5390-77</b>
F72	transparent bowl with manual drain transparent bowl with semi-automatic drain	<b>4266-50RF</b> <b>4266-52RF</b>
F73	transparent bowl with manual drain, 1/4 turn transparent bowl with auto drain	<b>4425-50RF</b> <b>4425-51RF</b>
F74	plastic bowl assembly with guard and 1/4 turn manual drain plastic bowl assembly with guard and automatic drain	<b>4325-51R</b> <b>4325-52R</b>



## Filter Drains

Used On	Description	Part #
F17,F74	auto drain	<b>3000-10</b>
	manual drain	<b>619-50</b>
	manual drain assembly	<b>2796-52</b>
F72,F73	auto drain	<b>4000-51R</b>
F72,F73 F74	manual drain	<b>619-50</b>

auto drain  
3000-10

## Filter Lens Kits

Used On	Description	Part #
F72	liquid level lens kit	<b>4380-020</b>
F73	liquid level lens kit	<b>4380-030</b>
F74	high pressure dome sight glass kit	<b>4380-051</b>

liquid level lens kit  
4380-030

## Filter Indicator Conversion Kit

## Features:

- allows addition of service life indicator in the field
- for general purpose and oil removal filters

Used On	Description	Part #
F72,F73,F74	service life indicator	<b>5797-50</b>



## Filter Service Kit

Used On	Description	Part #
F17	O-rings, seals, and gaskets	<b>5578-05</b>
F18		<b>5945-50</b>
F73		<b>4380-600</b>
F74		<b>4380-700</b>

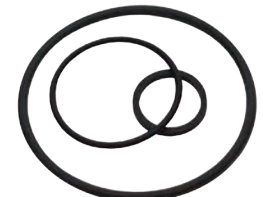

4380-700

## Filter Oil / Vapor Removal Filters

Used On	Description	Part #
F74C	oil removal filter	<b>4344-01</b>
F74H	oil removal filter	<b>4344-02</b>
F74V	vapor removal filter	<b>4341-01</b>



### Regulator Springs



4432-02

Used On	Pressure Ratings	Part #
R74	5-60 PSI 5-150 PSI	<b>4332-01</b> <b>4332-02</b>

### Tamper Resistant Covers

**Features:**

- helps prevent unauthorized pressure adjustment setting
- cover can be locked in place with up to four padlocks
- installs on adjusting knob



Used On	Description	Part #
R72	tamper resistant cover with seal wire	<b>4255-51</b>
R73	tamper resistant cover with seal wire	<b>4455-51</b>
R74	tamper resistant cover with seal wire	<b>4355-51</b>

### Regulator Panel Nuts



panel nut

Used On	Description	Part #
R07	plastic panel nut	<b>2962-89</b>
R08	plastic panel nut	<b>5191-89</b>
R17	metal panel nut	<b>5226-97</b>
R72	plastic panel nut	<b>4248-89</b>
R73	zinc panel nut	<b>5191-88</b>
R74	zinc panel nut	<b>4348-89</b>

### Regulator Diaphragm Relieving Kits



3407-02



4381-700

Used On	Description	Part #
R07	diaphragm, relieving	<b>3407-02</b>
R08		<b>5298-14</b>
R11		<b>529-03</b>
R17		<b>5578-02</b>
R72		<b>4381-500</b>
R73		<b>4381-600</b>
R74		<b>4381-700</b>

## Lubricator Bowl / Bowl Guards

Used On	Description	Part #
L07	polycarbonate bowl with manual drain	<b>3646-54</b>
L73	transparent bowl with manual drain	<b>4425-50RL</b>
L74	metal bowl with liquid level indicator and ¼ turn manual drain	<b>4303-77R</b>
	transparent bowl with manual drain	<b>4325-50R</b>



3646-54

## Seal Wire

## Features:

- provides tamper resistant protection of the lubricator drip rate setting

Used On	Description	Part #
L73, L74	metal wire	<b>2117-01</b>



seal wire

## Domes, Caps and Plugs

Used On	Description	Part #
L08	quick fill cap	<b>18-011-024</b>
L17, L74	quick fill cap	<b>18-011-021</b>
L73, L74	aluminum fill plug	<b>5301-55</b>
L17, L72, L73, L74	sight feed dome (micro-fogging design)	<b>4055-50</b>
L72, L74	sight feed dome (oil-fogging design)	<b>4055-51</b>
L74	high pressure sight feed dome	<b>5605-50</b>
	liquid level indicator repair kit	<b>4380-050</b>



18-011-021



5605-50

## Lubricator Seal Kits

Used On	Description	Part #
L17	O-rings, seals, and gaskets	<b>5771-02</b>
L73		<b>4382-600</b>
L74		<b>4382-700</b>

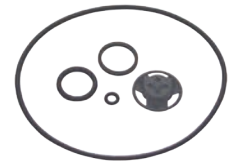

5771-02

## Quick Clamps and Brackets

### Features:

#### Quick-clamp

- provides modular installation capability
- flanges designated to slide into V grooves in clamp
- face-sealing O-rings provide a positive seal when clamp is closed and screw tightened

#### Bracket for quick-clamp

- provides secure mounting to a wall, machine panel or other flat surface

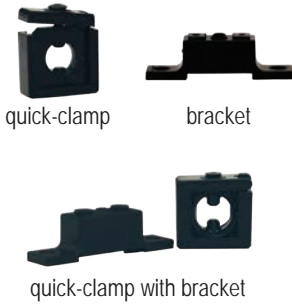

Used On Filter/ Regulator/ Lubricator Series	Description	Part #
L72	quick-clamp	<b>4214-51</b>
F72	quick-clamp service kit (2 O-rings)	<b>4384-570</b>
R72	quick-clamp and bracket assembly	<b>4214-52</b>
F73, F74, R73, R74, L72, L73	quick-clamp	<b>4314-51</b>
	quick-clamp service kit (2 O-rings)	<b>4384-770</b>
	wall bracket for quick-clamp (uses 7/32" screws)	<b>4313-50</b>
	quick-clamp and bracket assembly	<b>4314-52</b>

## Blocks

### Features:

- installed with quick-clamps
- provides additional outlets and manifolding capability



Used On Filter/ Regulator/ Lubricator Series	Description	Part #
F73, F74, R73, R74, L73, L74	porting block, three 1/4" PTF outlets	<b>4316-50</b>
	manifold block, three 3/4" PTF outlets	<b>4328-50</b>

## Pipe Adapters

### Features:

- installed with quick-clamps
- provides PTF connections to system piping
- sold individually



Used On Filter/ Regulator/ Lubricator Series	Description	Part #
L72, F72, R72	1/4" PTF connections	<b>4215-02</b>
	3/8" PTF connections	<b>4215-03</b>
F73, F74, R73, R74, L73, L74	1/4" PTF connections	<b>4315-01</b>
	3/8" PTF connections	<b>4315-02</b>
	1/2" PTF connections	<b>4315-03</b>
	3/4" PTF connections	<b>4315-04</b>

- Used on Filters / Regulators / Lubricator series

## Mounting Brackets

Used On	Description	Part #
F07	mounting bracket only	<b>5939-06</b>
L07	mounting bracket only	<b>5095-17</b>
F17, L17	mounting bracket kit for 3/4" and 1" ported units	<b>6212-50</b>



## Wall Mounting Brackets

**Features:**

- alternate to quick-clamps and pipe adapters
- used to secure to a wall, machine panel or other flat surface
- Use close nipples on page 662 to connect combination unit and then place in bracket.

Used On Filter/ Regulator/ Lubricator Series	Description	Part #
L72, F72, R72	wall mounting bracket for all F72 series	<b>4224-50</b>
L73, F73, R72	wall mounting bracket for all F73 series	<b>4424-50</b>
L74, F74, R74	wall mounting bracket for all F74 series	<b>4324-50</b>



## Regulator Mounting Brackets

Used On Filter/ Regulator/ Lubricator Series	Description	Part #
B07, R07	mounting bracket with plastic panel nut	<b>18-025-003</b>
B08, R08		<b>5203-06</b>
R17		<b>5570-04</b>



Watts Filters

F602 Compact

Features:

- 40 micron polypropylene element
- 4.4 oz. bowl
- zinc body
- maximum operating:
  - temperature range: **40°F (4°C) to 125°F (52°C)**
  - maximum pressure: **150 PSIG (10.2 bar)**



Polycarbonate bowl with guard

Polycarbonate Bowl with Metal Bowl Guard

Size	Flow (SCFM)	Automatic Drain Part #	Manual Drain Part #
¼"	53	<b>F602-02BJR</b>	<b>F602-02BJ</b>
⅜"	80	<b>F602-03BJR</b>	<b>F602-03BJ</b>
½"	85	<b>F602-04BJR</b>	<b>F602-04BJ</b>

Zinc Bowl with Sight Glass

Size	Flow (SCFM)	Automatic Drain Part #	Manual Drain Part #
¼"	53	<b>F602-028A</b>	<b>F602-024A</b>
⅜"	80	<b>F602-038A</b>	<b>F602-034A</b>
½"	85	<b>F602-048A</b>	<b>F602-044A</b>

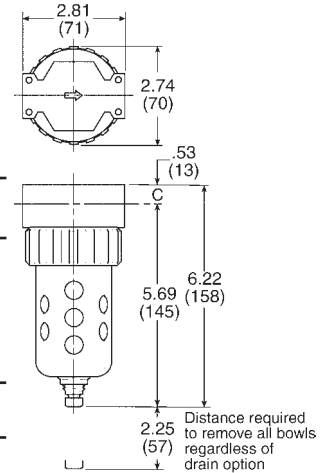

SCFM ratings given at 90 PSIG inlet pressure.

F602 Hi-Flow

Features:

- 40 micron polypropylene element
- automatic drain operating conditions:
  - temperature range: **40°F (4°C) to 120°F (49°C)**
  - maximum operating: **175 PSIG (12 bar)**
- manual drain operating conditions:
  - temperature range: **40°F (4°C) to 150°F (66°C)**
  - maximum operating: **250 PSIG (17 bar)**



Zinc Body with Sight Glass and 16" Bowl

Size	Flow (SCFM)	Automatic Drain Part #	Manual Drain Part #
¾"	270	<b>F602-06WJR</b>	<b>F602-06WJ</b>
1"	300	<b>F602-08WJR</b>	<b>F602-08WJ</b>
1½"	450	<b>F602-12WJR</b>	<b>F602-12WJ</b>

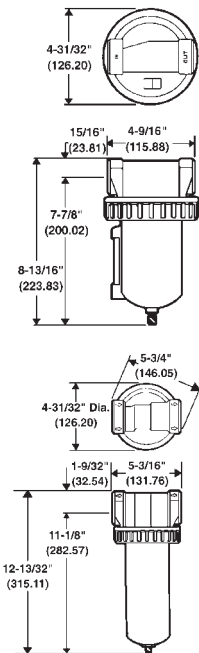

Aluminum Body with 26" Bowl

Size	Flow (SCFM)	Automatic Drain Part #	Manual Drain Part #
2"	1200	<b>F602-16WJR</b>	<b>F602-16WJ</b>

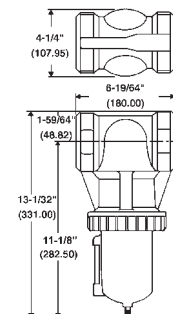

See pages 433 to 434 for accessories.

**!** FRL's are designed for air service only, unless otherwise indicated.

SCFM ratings given at 90 PSIG inlet pressure.

## Watts Filters/Regulators

### B11 Compact

**Features:**

- pressure range **2 - 125 PSIG** (.15 - 8.5 bar)
- temperature range: **40°F (4°C) to 120°F (49°C)**
- 40 micron filter
- 4 oz. bowl
- zinc body
- relieving type
- diaphragm operated
- spring adjustment mechanism
- glass-filled acetal plastic spring cage
- tamper resistant, snap lock, removable knobs
- uses a GC230 gauge (not supplied)

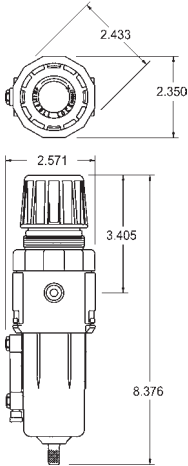

Size	Flow (SCFM)	Automatic Drain	Manual Drain
		Part #	Part #
1/4"	60	<b>B11-02WJCR</b>	<b>B11-02WJC</b>
3/8"	70	<b>B11-03WJCR</b>	<b>B11-03WJC</b>
1/2"	80	<b>B11-04WJCR</b>	<b>B11-04WJC</b>

SCFM ratings given at 100 PSIG inlet pressure.



Pneumatic  
Accessories

## Watts Regulators

### R643 Miniature

**Features:**

- pressure range **2 - 125 PSIG** (.15 - 8.5 bar)
- inlet pressure: **300 PSIG** (20.4 bar) maximum
- temperature range: **40°F (4°C) to 120°F (49°C)**
- relieving type
- diaphragm operated
- non-rising adjusting knob
- 1/8" gauge port

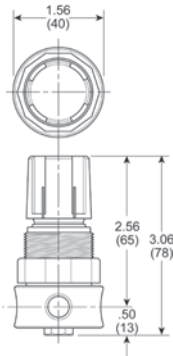

Size	Flow (SCFM)	Body Material	With Gauge	Without Gauge
			Part #	Part #
1/4"	10	brass	<b>R364-02CG</b>	<b>R364-02C</b>
		aluminum	<b>R374-02CG</b>	<b>R374-02C</b>

**NEW**

SCFM ratings given at 100 PSIG inlet pressure.



See pages 433 to 434 for accessories.

FRL's are designed for air service only, unless otherwise indicated.

SCFM ratings given at 100 PSIG inlet pressure.

Watts Regulators



R11 Compact

Features:

- pressure range **2 - 125 PSIG** (.15 - 8.5 bar)
- inlet pressure: **300 PSIG** (20.4 bar) maximum
- temperature range: **40°F (4°C) to 120°F (49°C)**
- zinc body
- relieving type
- diaphragm operated
- spring adjustment mechanism
- t-handle design
- uses a GC230 gauge

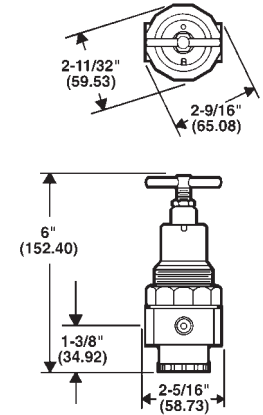

Size	Flow (SCFM)	With Gauge Part #	Without Gauge Part #
1/4"	80	<b>R11-02CG</b>	<b>R11-02C</b>
3/8"	80	<b>R11-03CG</b>	<b>R11-03C</b>
1/2"	100	<b>R11-04CG</b>	<b>R11-04C</b>

SCFM ratings given at 100 PSIG inlet pressure.

R119 Standard

Features:

- pressure range **2 - 125 PSIG** (.15 - 8.5 bar)
- inlet pressure: **300 PSIG** (20.4 bar) maximum
- temperature range: **40°F (4°C) to 120°F (49°C)**
- zinc body
- relieving type
- diaphragm operated
- spring adjustment mechanism
- t-handle design
- brass bottom plug
- aluminum spring cage
- uses a GC230 gauge

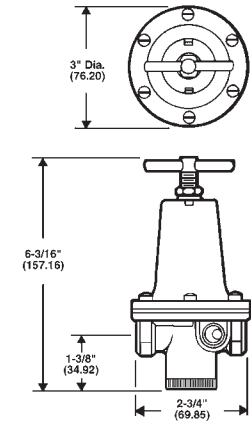

Size	Flow (SCFM)	With Gauge Part #	Without Gauge Part #
1/4"	100	<b>R119-02CG</b>	<b>R119-02C</b>
3/8"	110	<b>R119-03CG</b>	<b>R119-03C</b>
1/2"	150	<b>R119-04CG</b>	<b>R119-04C</b>

SCFM ratings given at 100 PSIG inlet pressure.

R119 High-Flow

Features:

- pressure range **2 - 125 PSIG** (.15 - 8.5 bar)
- inlet pressure: **300 PSIG** (20.4 bar) maximum
- temperature range: **40°F (4°C) to 120°F (49°C)**
- zinc body
- relieving type
- diaphragm operated
- spring adjustment mechanism
- t-handle design
- acetal bottom plug
- aluminum spring cage
- uses a GC230 gauge

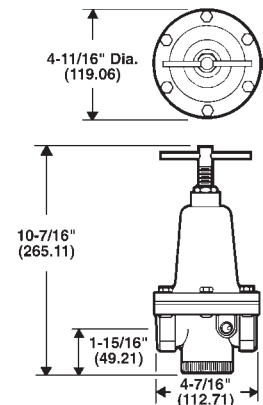

Size	Flow (SCFM)	With Gauge Part #	Without Gauge Part #
3/4"	300	<b>R119-06CG</b>	<b>R119-06C</b>
1"	400	<b>R119-08CG</b>	<b>R119-08C</b>
1 1/2"	500	<b>R119-12CG</b>	<b>R119-12C</b>

SCFM ratings given at 100 PSIG inlet pressure.

See pages 433 to 434 for accessories.

FRL's are designed for air service only, unless otherwise indicated.



## Watts Lubricators

### General Features:

- general purpose use
- high performance over a very wide flow range

Pneumatic  
Accessories

### L606 Compact

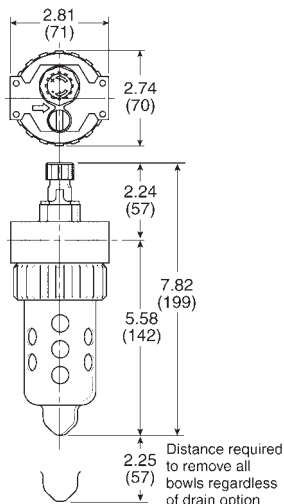

### Features:

- 2.6 oz. bowl
- zinc body
- micromist
- maximum operating conditions:
  - temperature range: **40°F (4°C) to 125°F (52°C)**
  - maximum operating pressure: **150 PSIG (10.2 bar)**

Size	Flow (SCFM)	Polycarbonate Bowl with Metal Bowl Guard Part #	Zinc Bowl Sight Glass with Twist Drain Part #
1/4"	40	<b>L606-02B</b>	<b>L606-024B</b>
3/8"	60	<b>L606-03B</b>	<b>L606-034B</b>
1/2"	90	<b>L606-04B</b>	<b>L606-044B</b>



Polycarbonate bowl with guard

SCFM ratings given at 90 PSIG inlet pressure.

### L606 Standard

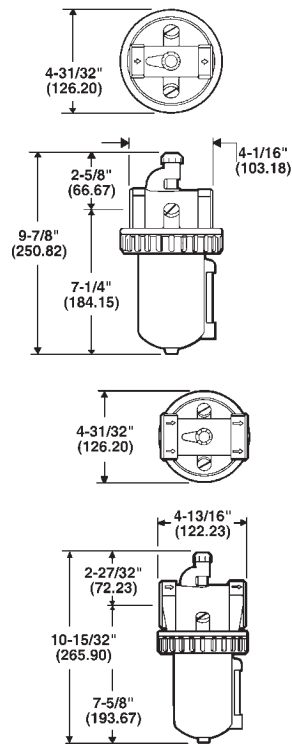

### Features:

- 16 oz. bowl
- zinc body
- maximum operating conditions:
  - temperature range: **40°F (4°C) to 150°F (66°C)**
  - maximum operating pressure: **250 PSIG (17 bar)**
- 3/4", 1" and 1 1/2" are fillable while under pressure

Size	Flow (SCFM)	Zinc Bowl with Sight Glass Part #
3/4"	325	<b>L606-06W</b>
1"	350	<b>L606-08W</b>
1 1/2"	400	<b>L606-12W</b>



L606-12W

See pages 433 to 434 for accessories.  
See page 367 for air tool lubricant.

FRL's are designed for air service only, unless otherwise indicated.

SCFM ratings given at 90 PSIG inlet pressure.

## Watts Combination Units

## C11 Compact

## Features:

- 4.5 oz. bowl
- 40 micron polypropylene element
- zinc body
- maximum operating conditions:
  - temperature range: **40°F to 120°F (4°C to 49°C)**
  - maximum operating pressure: **150 PSIG (10.2 bar)**

## Polycarbonate Bowl with Metal Bowl Guard

Size	Flow (SCFM)	Automatic Drain Part #	Manual Drain Part #
¼"	40	<b>C11-02A</b>	<b>C11-02M</b>
⅜"	60	<b>C11-03A</b>	<b>C11-03M</b>
½"	85	<b>C119-04A</b>	<b>C119-04M</b>

SCFM ratings given at 90 PSIG inlet pressure.

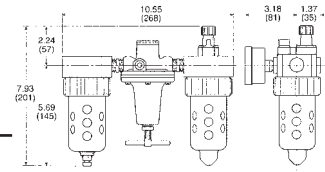
Pneumatic  
Accessories

## C119 Standard

## Features:

- 16 oz. bowl
- 40 micron polypropylene element
- zinc body
- maximum operating conditions:
  - temperature range: **40°F to 150°F (4°C to 66°C)**
  - maximum operating pressure: **250 PSIG (17 bar)**

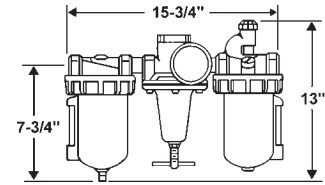

## Zinc Bowl with Sight Glass

Size	Flow (SCFM)	Automatic Drain Part #	Manual Drain Part #
¾"	275	<b>C119-06AMB</b>	<b>C119-06MMB</b>
1"	320	<b>C119-08AMB</b>	<b>C119-08MMB</b>
1½"	550	<b>C119-12AMB</b>	<b>C119-12MMB</b>

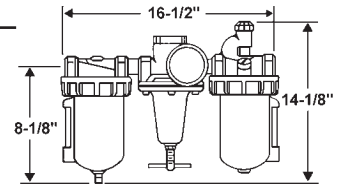

⚠ FRL's are designed for air service only, unless otherwise indicated.

SCFM ratings given at 90 PSIG inlet pressure.

Watts Kits & Accessories

Filter Elements

Used On	Description	Part #
F602-02, F602-03, F602-04	40 micron	<b>PS701</b>
F602-06, F602-08, F602-12	5 micron	<b>EK602VB</b>
F602-06, F602-08, F602-12	40 micron	<b>EK602B</b>
F602-16	40 micron	<b>EK602G</b>



Pneumatic  
Accessories

Bowl with Twist Drain

Used On	Description	Part #
F602-02 F602-03 F602-04	polycarbonate bowl with twist drain	<b>PS732</b>



Filter Drains

Used On	Description	Part #
F602, F602-03, F602-04	auto float drain	<b>PS506</b>
	twist drain	<b>PS512</b>



PS512

## Watts Kits &amp; Accessories

Pneumatic  
Accessories

## Regulator Repair Kits

Used On	Description	Part #
R11	relieving diaphragm, valve assembly	<b>RKR10Y</b>
R119-02		<b>RK119Y</b>
R119-03		<b>RK119A</b>
R119-04		<b>RK119B</b>
R119-06		<b>RK119D</b>
R119-08		<b>RKR164Y</b>
R119-12		
R364-02		

## Lubricant Repair Kit



Used On	Description	Part #
L606-06 L606-08 L606-12	sight glass	<b>RKB605WB</b>

## Lubricator Mounting Brackets

Used On	Description	Part #
L606-02, F602-02, L606-03, F602-03, L606-04, F602-04	mounting bracket	<b>PS743</b>
F602 ¾", L606-06, F602-06	mounting bracket (2 required)	<b>SA200AW57</b>
F602 1", L606-08, F602-08	mounting bracket (2 required)	<b>SA200CW57</b>



## Regulator Mounting Brackets



SA15Y57



SA15Y57

Used On	Description	Part #
R11, B11	mounting bracket with panel nut	<b>SAR10Y57</b>
R119-02 R119-03	mounting bracket	<b>SA15Y57</b>
R119-04	mounting bracket	<b>18A57</b>
R119-06 R119-08 R119-12	mounting bracket	<b>18B57</b>
R364-02	mounting bracket with panel nut	<b>SA161X57</b>

## Dixon® Gauges

### Applications:

- All of the gauges supplied by Dixon® are designed for long, reliable service under rugged conditions. Typical applications include those on pumps, hydraulic and pneumatic systems, compressors, machine tools and many other installations where it is necessary to have a gauge with a non-corrosive movement. The gauges available include standard dry and liquid-filled pressure gauges, compound pressure gauges, vacuum gauges and welding gauges. Materials available include brass, stainless steel and plastic.

**Fig. Inter.** - Figure Interval. (Increments between PSI numbers on gauge face.)

**Grad. Inter.** - Graduation Interval. (Fractional increments between PSI numbers on gauge face.)

### ABS Standard Dry Gauges

#### Features:

- ASME B40.1, Grade B ( $\pm 3-2-3\%$  accuracy)
- PowerFlex™ movement with polyester segment, designed to resist the effects of shock, vibration and pulsation.
- ABS plastic case, corrosion resistant
- c-shaped bronze safety bourdon tube (600 PSI and lower)
- helical wound bronze safety bourdon tube (1000 PSI and higher)
- polycarbonate window
- black aluminum pointer
- ambient temperature range: **-40°F to 150°F (-40°C to 66°C)**

#### Center Back Mounts

PSI Range	Fig. Inter.	Minor Grad.	1½" Face ⅛" Center Back Mount Part #	2" Face ¼" Center Back Mount Part #
0-15	1	.5	---	<b>GC200</b>
0-30	5	.5	<b>GC605</b>	<b>GC215</b>
0-60	5	1	<b>GC610</b>	<b>GC220</b>
0-100	10	2	<b>GC615</b>	<b>GC225</b>
0-160	20	5	<b>GC620</b>	<b>GC230</b>
0-200	20	5	<b>GC625</b>	<b>GC235</b>
0-300	30	5	---	<b>GC240</b>



GC230



#### Lower Mounts

PSI Range	Fig. Inter.	Minor Grad.	2" face, ¼" lower mount Part #	2½" face ¼" lower mount Part #	3½" face ¼" lower mount Part #
0-15	1	.5	<b>GL100</b>	<b>GL300</b>	<b>GS15-4</b>
0-30	5	.5	<b>GL115</b>	<b>GL320</b>	<b>GS30-4</b>
0-60	5	1	<b>GL120</b>	<b>GL325</b>	<b>GS60-4</b>
0-100	10	2	<b>GL125</b>	<b>GL330</b>	<b>GS100-4</b>
0-160	20	5	<b>GL130</b>	<b>GL335</b>	<b>GS160-4</b>
0-200	20	5	<b>GL135</b>	<b>GL340</b>	<b>GS200-4</b>
0-300	30	5	<b>GL140</b>	<b>GL345</b>	<b>GS300-4</b>
0-400	50	10	---	<b>GL347</b>	<b>GS400-4</b>
0-600	50	10	---	<b>GL350</b>	<b>GS600-4</b>
0-1000	200	20	---	<b>GL355</b>	<b>GS1000-4</b>
0-1500	300	50	---	<b>GL360</b>	---
0-2000	400	50	---	<b>GL365</b>	---
0-3000	500	100	---	<b>GL370</b>	---
0-5000	1000	100	---	<b>GL375</b>	---



GL140

## Stainless Steel Dry Gauges

**Applications:**

- Designed for severe service applications, providing the corrosion resistance and durability of a permanently sealed gauge.

**Features:**

- $\pm 2-1-2\%$  accuracy
- 304 stainless steel case and crimp ring
- polycarbonate window
- $\frac{1}{4}$ " NPT lower mount stainless connector
- 316 stainless bourdon tube and socket
- ambient temperature range:  $-40^{\circ}\text{F}$  to  $140^{\circ}\text{F}$  ( $-40^{\circ}\text{C}$  to  $60^{\circ}\text{C}$ )



GSS100

PSI Range	Fig. Inter.	Minor Grad.	2 1/2" Face 1/4" Lower Mount Part #
0-15	3	.2	<b>GSS15</b>
0-30	5	.5	<b>GSS30</b>
0-60	10	1	<b>GSS60</b>
0-100	20	2	<b>GSS100</b>
0-160	20	2	<b>GSS160</b>
0-200	50	5	<b>GSS200</b>
0-300	50	5	<b>GSS300</b>
0-400	100	10	<b>GSS400</b>
0-600	100	10	<b>GSS600</b>
0-1000	200	20	<b>GSS1000</b>
0-1500	300	20	<b>GSS1500</b>
0-2000	500	50	<b>GSS2000</b>
0-3000	500	50	<b>GSS3000</b>
0-5000	1000	100	<b>GSS5000</b>
0-10000	2000	200	<b>GSS10000</b>

**Features:**

- 1.6% accuracy, exceeds ASME B.40.100 Grade B
- 304 series stainless case
- polycarbonate window,  $3\frac{1}{2}$ " across
- $\frac{1}{4}$ " NPT lower mount stainless connector
- 316L stainless bourdon tube and socket, polyester segment
- temperature range:  $-40^{\circ}\text{F}$  to  $140^{\circ}\text{F}$  ( $-40^{\circ}\text{C}$  to  $60^{\circ}\text{C}$ )



GSS160-4

PSI Range	Fig. Inter.	Minor Grad.	4" Face 1/4" Lower Mount Part #
0-15	3	.5	<b>GSS15-4</b>
0-30	5	.5	<b>GSS30-4</b>
0-60	10	1	<b>GSS60-4</b>
0-100	20	2	<b>GSS100-4</b>
0-160	20	2	<b>GSS160-4</b>
0-200	40	5	<b>GSS200-4</b>
0-300	50	5	<b>GSS300-4</b>
0-400	50	10	<b>GSS400-4</b>
0-600	100	10	<b>GSS600-4</b>
0-1000	200	10	<b>GSS1000-4</b>
0-1500	200	20	<b>GSS1500-4</b>
0-3000	500	50	<b>GSS3000-4</b>
0-5000	1000	100	<b>GSS5000-4</b>
0-10000	2000	200	<b>GSS10000-4</b>

## Brass Standard Dry Gauges

## Features:

- ASME B40.100 Grade B ( $\pm 3/2/3\%$  accuracy)
- polished brass case and ring
- copper alloy bourdon tube
- dual PSI / kPa scale dial
- temperature range **-40°F to 140°F (-40°C to 60°C)**

PSI Range	Fig. Inter.	Grad. Inter.	2½" Face ¼" Lower Mount Part #
0-15	3	.2	<b>GBR15</b>
0-30	5	.5	<b>GBR30</b>
0-60	10	1	<b>GBR60</b>
0-100	20	2	<b>GBR100</b>
0-160	20	2	<b>GBR160</b>
0-200	50	5	<b>GBR200</b>
0-300	50	5	<b>GBR300</b>
0-400	100	10	<b>GBR400</b>
0-600	100	10	<b>GBR600</b>
0-1000	200	20	<b>GBR1000</b>
0-1500	300	20	<b>GBR1500</b>
0-2000	500	50	<b>GBR2000</b>
0-3000	500	50	<b>GBR3000</b>
0-5000	1000	100	<b>GBR5000</b>

Pneumatic  
Accessories

## Process Gauges

## Applications:

- Specifically designed for process, chemical and petroleum industries. Process gauges are engineered to deliver years of accurate service while withstanding vibration, corrosive media and corrosive atmosphere.

## Features:

- temperature range: dry **-40°F to 200°F (-40°C to 93°C)**
- case: black impact resistant thermoplastic, with safety blowout back, solid front, integral back flange (dry)
- ring: ethylene propylene
- wetted parts: 316L stainless steel
- window: polycarbonate
- dial: white aluminum
- pointer: black aluminum
- accuracy:  $\pm 0.5\%$  ANSI/ASME Grade 2A
- scale: single scale PSI only

PSI Range	Fig. Inter.	Grad. Inter.	4½" Face ½" Lower Mount Part #
0-30	5	.2	<b>PGS30</b>
0-60	10	.5	<b>PGS60</b>
0-100	10	1	<b>PGS100</b>
0-160	20	1	<b>PGS160</b>
0-200	20	2	<b>PGS200</b>
0-300	50	2	<b>PGS300</b>
0-600	10	5	<b>PGS600</b>
0-1000	100	10	<b>PGS1000</b>



## FlutterGuard™ Dry Gauges

**Features:**

- FlutterGuard™ virtually eliminates pointer flutter, making the gauge easier to read and reducing excessive movement wear. Liquid-free casing results in lighter weight and eliminates the chance of gauge leakage.
- ASME B40.1, Grade B ( $\pm 3\text{-}2\text{-}3\%$  accuracy)
- ABS plastic case, corrosion resistant
- C-shaped bronze safety bourdon tube (600 PSI gauges and lower)
- helical wound bronze safety bourdon tube (1000 PSI gauges and higher)
- polycarbonate window
- black aluminum pointer
- PowerFlex™ movement with polyester segment, designed to resist the effects of shock, vibration and pulsation.
- ambient temperature range of **-40°F to 150°F (-40°C to 66°C)**



PSI Range	Fig. Inter.	Minor Grad.	2½" Face ¼" Lower Mount Part #
0-15	1	.5	<b>GL300FG</b>
0-30	5	.5	<b>GL320FG</b>
0-60	5	1	<b>GL325FG</b>
0-100	10	2	<b>GL330FG</b>
0-160	20	5	<b>GL335FG</b>
0-200	20	5	<b>GL340FG</b>
0-300	30	5	<b>GL345FG</b>
0-400	50	10	<b>GL347FG</b>
0-600	50	10	<b>GL350FG</b>
0-1000	200	20	<b>GL355FG</b>
0-1500	300	50	<b>GL360FG</b>
0-2000	400	50	<b>GL365FG</b>
0-3000	500	100	<b>GL370FG</b>
0-5000	1000	100	<b>GL375FG</b>



## Stainless Panel Builder Gauges

**Applications:**

- fits industry standard 2.56" panel hole cutout
- suitable for corrosive environments
- used in gaseous and liquid media

**Features:**

- ASME B40.100 Grade A  $\pm 2-1-2\%$  full scale accuracy
- 316L stainless steel wetted parts
- 304 stainless steel case and ring
- white aluminum with black lettering; stop pin
- black aluminum pointer
- glycerin filled case
- laminated safety glass window lens
- ambient temperature range:  $-4^{\circ}\text{F}$  to  $140^{\circ}\text{F}$  ( $-20^{\circ}\text{C}$  to  $60^{\circ}\text{C}$ )
- maximum media temperature  $212^{\circ}\text{F}$  maximum

PSI Range	Fig. Inter.	Minor Grad.	2½" Face ¼" Lower Back Mount Part #
0-15	3	.2	<i>PBLSS15</i>
0-30	5	.5	<i>PBLSS30</i>
0-60	10	1	<i>PBLSS60</i>
0-100	20	2	<i>PBLSS100</i>
0-160	20	2	<i>PBLSS160</i>
0-200	50	5	<i>PBLSS200</i>
0-300	50	5	<i>PBLSS300</i>
0-400	100	10	<i>PBLSS400</i>
0-600	100	10	<i>PBLSS600</i>
0-800	200	20	<i>PBLSS800</i>
0-1000	200	20	<i>PBLSS1000</i>
0-1500	300	20	<i>PBLSS1500</i>
0-2000	500	50	<i>PBLSS2000</i>
0-3000	500	50	<i>PBLSS3000</i>
0-5000	1000	100	<i>PBLSS5000</i>



## Contractor Pressure Gauges

**Features:**

- accuracy class:  $\pm 1\%$  of span
- wetted parts: copper alloy
- window: acrylic, snap in
- dial: aluminum, white
- pointer: aluminum, black, adjustable
- mounting flanged/bracket; rear flange: stainless steel
- case: stainless steel

PSI Range	4½" face, ¼" Lower Mount Part #
0-15	<i>4277750-0001</i>
0-30	<i>4277768-0001</i>
0-60	<i>4277776-0003</i>





## Compound Gauges

## Features:

- ASME B40.1, Grade B accuracy ( $\pm 3-2-3$  % accuracy)
- ABS plastic case, corrosion resistant
- bronze bourdon tube / brass socket
- polycarbonate window
- black aluminum pointer
- Powerflex movement with polyester segment, designed for extended wear
- temperature range of **-40°F to 150°F (-40°C to 66°C)**

Mercury (Hg)	PSI Range	Fig. Inter. (Hg / PSI)	Minor Grad. (Hg / PSI)	2½" Face	2½" Face
				¼" Center Back Mount Part #	¼" Lower Mount Part #
30"	0-100	30 / 10	5 / 2	---	<b>GL310</b>
	0-160	30 / 20	5 / 5	<b>GC210</b>	---
	0-160	30 / 20	10 / 10	---	<b>GL110</b>
	0-200	30 / 20	10 / 10	---	<b>GL315</b>

## Vacuum Gauges

## Features:

- ASME B40.1, Grade B accuracy ( $\pm 3-2-3$  % accuracy)
- ABS plastic case
- bronze bourdon tube
- polycarbonate crystal
- black aluminum pointer
- Powerflex movement with polyester segment, designed for extended wear
- temperature range: **-40°F to 150°F (-40°C to 66°C)**



Mercury (Hg)	Fig. Inter. (Hg / PSI)	Minor Grad. (Hg / PSI)	2" Face	2" Face	2½" Face
			¼" Lower Mount Part #	¼" Center Back Mount Part #	¼" Lower Mount Part #
30"	5"	.5"	<b>GL105</b>	<b>GC205</b>	<b>GL305</b>

## ABS Case Liquid Filled Gauges

**Feature:**

- ASME B40.100, Grade B ( $\pm 3-2-3\%$  accuracy)

PSI Range	Fig. Inter.	Minor Grad.	2½" Face ¼" Lower Mount Part #
0-15	3	.2	<i>GLP500</i>
0-30	5	.5	<i>GLP505</i>
0-60	10	1	<i>GLP510</i>
0-100	20	2	<i>GLP515</i>
0-160	20	2	<i>GLP517</i>
0-200	50	5	<i>GLP520</i>
0-300	50	5	<i>GLP525</i>
0-400	100	10	<i>GLP527</i>
0-600	100	10	<i>GLP530</i>
0-1000	200	20	<i>GLP535</i>
0-1500	300	20	<i>GLP540</i>
0-2000	500	50	<i>GLP545</i>
0-3000	500	50	<i>GLP550</i>
0-5000	1000	100	<i>GLP555</i>



Pneumatic  
Accessories

## Stainless Case Liquid Filled Gauges

**Features:**

- PowerFlex™ movement with polyester segment designed to resist the effects of shock, vibration and pulsation.
- ASME B40.100, Grade A ( $\pm 2-1-2\%$  accuracy)
- copper alloy bourdon tube
- white aluminum dial with black numbers and black aluminum pointer
- ¼" NPT brass connection
- glycerin filled
- polycarbonate window
- temperature range: **-4°F to 150°F (-20°C to 65°C)**

PSI Range	Fig. Inter.	Minor Grad.	2½" Face ¼" Center Back Mount Part #	2½" Face, ¼" Lower Mount Part #
0-15	3	.5	<i>GLSC400</i>	<i>GLS400</i>
0-30	5	.5	<i>GLSC405</i>	<i>GLS405</i>
0-60	10	1	<i>GLSC410</i>	<i>GLS410</i>
0-100	20	2	<i>GLSC415</i>	<i>GLS415</i>
0-160	20	2	<i>GLSC417</i>	<i>GLS417</i>
0-200	40	5	<i>GLSC420</i>	<i>GLS420</i>
0-300	50	5	<i>GLSC425</i>	<i>GLS425</i>
0-400	50	5	<i>GLSC427</i>	<i>GLS427</i>
0-600	100	10	<i>GLSC430</i>	<i>GLS430</i>
0-1000	200	10	<i>GLSC435</i>	<i>GLS435</i>
0-1500	300	50	<i>GLSC440</i>	<i>GLS440</i>
0-2000	400	20	<i>GLSC445</i>	<i>GLS445</i>
0-3000	500	50	<i>GLSC450</i>	<i>GLS450</i>
0-5000	1000	100	<i>GLSC455</i>	<i>GLS455</i>



GLSC420



GLS430



## Stainless Steel Liquid Filled Gauges

**Applications:**

Designed for severe service applications, providing the corrosion resistance and durability of a permanently sealed gauge.

**Features:**

- $\pm 2-1-2\%$  accuracy
- polycarbonate window
- $\frac{1}{4}$ " NPT lower mount stainless connector
- 304 stainless case and crimp ring
- glycerin filled
- ambient temperature range:  $-4^{\circ}\text{F}$  to  $140^{\circ}\text{F}$  ( $-20^{\circ}\text{C}$  to  $60^{\circ}\text{C}$ )



GLSS1500

PSI Range	Fig. Inter.	Minor Grad.	$\frac{2}{2}$ " Face $\frac{1}{4}$ " Lower Mount Part #
0-15	3	.2	<b>GLSS15</b>
0-30	5	.5	<b>GLSS30</b>
0-60	10	1	<b>GLSS60</b>
0-100	20	2	<b>GLSS100</b>
0-160	20	2	<b>GLSS160</b>
0-200	50	5	<b>GLSS200</b>
0-300	50	5	<b>GLSS300</b>
0-400	100	10	<b>GLSS400</b>
0-600	100	10	<b>GLSS600</b>
0-1000	200	20	<b>GLSS1000</b>
0-1500	300	20	<b>GLSS1500</b>
0-2000	500	50	<b>GLSS2000</b>
0-3000	500	50	<b>GLSS3000</b>
0-5000	1000	100	<b>GLSS5000</b>
0-10000	2000	200	<b>GLSS10000</b>

## All Stainless Steel Liquid Filled Gauges

**Applications:**

Designed for severe service applications, providing the corrosion resistance and durability of a permanently sealed gauge.

**Features:**

- $\pm 2-1-2\%$  accuracy
- polycarbonate window
- $\frac{1}{4}$ " NPT center back mount stainless connector
- 304 stainless case and crimp ring
- glycerin filled
- ambient temperature range:  $-4^{\circ}\text{F}$  to  $140^{\circ}\text{F}$  ( $-20^{\circ}\text{C}$  to  $60^{\circ}\text{C}$ )



PSI Range	Fig. Inter.	Minor Grad.	$\frac{2}{2}$ " Face $\frac{1}{4}$ " Center Back Mount Part #
0-100	20	2	<b>GLSSC100</b>
0-160	20	2	<b>GLSSC160</b>
0-200	50	5	<b>GLSSC200</b>

## Brass Liquid Filled Gauges

## Features:

- $\pm 2$ -1-2% accuracy on 2½";  $\pm 1$ % accuracy on 4"
- acrylic window with membrane assembly
- copper alloy bourdon tube
- brass movement with highly polished bearing surfaces
- glycerin filled
- 2½" face gauges: solid cast brass case with polished ABS cover ring
- 4" face gauges: cast brass, silver painted case with chrome plated brass cover ring
- ambient temperature range: -4°F to 140°F (-20°C to 60°C)

PSI Range	Fig. Inter.	Minor Grad.	2½" Face ¼" Lower Mount Part #	2½" Face ¼" Center Back Mount Part #	4" Face ½" Lower Mount Part #
0-15	3	.2	<b>GLBR15</b>	<b>GLBRC15</b>	<b>GLBR15-4</b>
0-30	5	.5	<b>GLBR30</b>	<b>GLBRC30</b>	<b>GLBR30-4</b>
0-60	10	1	<b>GLBR60</b>	<b>GLBRC60</b>	<b>GLBR60-4</b>
0-100	10	1	<b>GLBR100</b>	<b>GLBRC100</b>	<b>GLBR100-4</b>
0-160	20	2	<b>GLBR160</b>	<b>GLBRC160</b>	<b>GLBR160-4</b>
0-200	20	2	<b>GLBR200</b>	<b>GLBRC200</b>	<b>GLBR200-4</b>
0-300	50	5	<b>GLBR300</b>	<b>GLBRC300</b>	<b>GLBR300-4</b>
0-400	50	5	<b>GLBR400</b>	<b>GLBRC400</b>	<b>GLBR400-4</b>
0-600	100	10	<b>GLBR600</b>	<b>GLBRC600</b>	<b>GLBR600-4</b>
0-1000	100	10	<b>GLBR1000</b>	<b>GLBRC1000</b>	<b>GLBR1000-4</b>
0-1500	300	20	<b>GLBR1500</b>	<b>GLBRC1500</b>	<b>GLBR1500-4</b>
0-2000	200	20	<b>GLBR2000</b>	<b>GLBRC2000</b>	<b>GLBR2000-4</b>
0-3000	500	50	<b>GLBR3000</b>	<b>GLBRC3000</b>	<b>GLBR3000-4</b>
0-5000	500	50	<b>GLBR5000</b>	<b>GLBRC5000</b>	<b>GLBR5000-4</b>
0-10000	1000	100	---	---	<b>GLBR10000-4</b>



## Welding Gauges

## Features:

- $\pm 3$ -2-3% accuracy according to ASME B40.100 Grade B
- polished drawn stainless steel case
- twist-lock polycarbonate window
- copper alloy bourdon tube
- "USE NO OIL" written in red on face
- ambient temperature range: -40°F to 140°F (-20°C to 60°C)

PSI Range	Fig. Inter.	Minor Grad.	2½" Face ¼" Lower Mount Part #
0-30	5	.5	<b>GBRW30</b>
0-30	5	.5	<b>GBRW30R<sup>1</sup></b>
0-60	10	1	<b>GBRW60</b>
0-100	20	2	<b>GBRW100</b>
0-200	50	5	<b>GBRW200</b>
0-400	100	10	<b>GBRW400</b>
0-600	100	10	<b>GBRW600</b>
0-4000	500	100	<b>GBRW4000</b>



<sup>1</sup> red band between 15 to 30 PSI on GBRW30R

## General Purpose Digital Gauges

**Applications:**

- General purpose digital gauges are suitable for dry air applications and other media. Gauge offers selectable units of measure so rather than purchasing one gauge for each unit of measure required, one gauge can be used for multiple units of measure.
- ideal for test applications and for use in technicians tool kits

**Features:**

- 0.5% terminal point accuracy
- five-digit LCD display with large size .48" characters
- bar graph display (20 segment)
- 9 engineering units (accessed through keypad): PSI, in. HG, cm Hg, mm Hg, KPA, Mpa, BAR, KG/cm<sup>2</sup>, ft H<sub>2</sub>O
- IP67 weatherproof enclosure, polycarbonate / ABS
- two AA alkaline batteries included
- 2000 hour minimum battery life
- wetted parts: 17-4 PH stainless steel sensor with 316L stainless steel socket
- operating temperature: **-4°F to 140°F (-20°C to 60°C)**
- polycarbonate window
- other pressure and compound ranges available



PSI Range	2½" Face ¼" Lower Mount Part #
0-100	<b>DG100</b>
0-300	<b>DG300</b>
0-1000	<b>DG1000</b>
0-10,000	<b>DG10000</b>

## 180° Steam Gauge Siphons

**Application:**

- In steam service, the siphon will prevent hot steam from entering a pressure gauge, diaphragm seal or transmitter. Recommended for applications involving temperatures above **100°F (37°C)**. Also use siphons whenever condensing hot vapors (not just steam) are present.

**Features:**

- red brass pipe
- complies with ASTM B-43
- pressure rating: **200 PSI at 406°F (208°C)**



Male IPS	Red Brass Part #
¼"	<b>401-01</b>

**Features:**

- steel pipe
- ¼" NPT schedule 40 steel, welded
- pressure rating: **175 PSI at 340°F (171°C)**



Male IPS	Steel Part #
¼"	<b>401-01S</b>

## Bi-Metal Thermometers

**Features:**

- case: sturdy, corrosion resistant series 304 stainless steel
- bezel crystal: optically clear, strong glass, gasketed to maintain weather-tight integrity is standard
- stem: 304 series stainless steel, welded at tip and case connector to prevent leakage, 1/4" (6.35 mm) diameter
- hermetically sealed per ASME B40.3 external reset
- slotted-hex adjustment head offers screwdriver or wrench use to field calibrate the thermometer
- bi-metal element: an extremely responsive temperature sensing helix which has been carefully sized and tested, heat treated and aged to relieve inherent stresses and insure continued accuracy
- dampening: bi-metal helix is coated with a viscous silicone to minimize pointer oscillation and to improve temperature transmission
- immersion: for accurate temperature readings, immerse stem a minimum of 2" (50 mm) in agitated liquids or 4" (100 mm) in moving air or gas
- over range: temporary over or under range of 50% of scale up to **260°C or 500°F** will not affect the instrument accuracy
- accuracy: guaranteed to be accurate to within 1% of full scale (Grade A per ASME B40.3) (The American Society of Mechanical Engineers issued a new standard for Bi-Metal Thermometers in 1990 referred to as ASME B40.3.)
- standard connection is 1/2" male NPT

### Model 30 Back Connected

Stem Length	Temperature Range	3" Face Part #
2½"	0-250°F/-20-120°C	30025064
2½"	50-500°F/10-260°C	30025104
4"	0-250°F/-20-120°C	30040064
4"	50-500°F/10-260°C	30040104
6"	0-250°F/-20-120°C	30060064
6"	50-500°F/10-260°C	30060104
9"	0-250°F/-20-120°C	30090064
9"	50-500°F/10-260°C	30090104



### Model 31 Bottom Connected 90° Angle

Stem Length	Temperature Range	3" Face Part #
2½"	0-250°F/-20-120°C	31025064
4"	50-500°F/10-260°C	31040104



### Model 50 Back Connected

Stem Length	Temperature Range	5" Face Part #
2½"	50-500°F/10-260°C	50025104
4"	0-250°F/-20-120°C	50040064



### Model 52 Adjustable Angle

Stem Length	Temperature Range	5" Face Part #
2½"	0-250°F/-20-120°C	52025064
4"	0-250°F/-20-120°C	52040064
4"	50-500°F/10-260°C	52040104





## Bi-Metal Pocket Thermometers

**Features:**

- case: 304 stainless steel hermetically sealed
- crystal: extra heavy polycarbonate
- stem: 304 series stainless steel
- external reset with hex nut on back of case
- bi-metal element: responsive actuation by bi-metal helix
- dampening: bi-metal helix is coated with a viscous silicone to minimize pointer oscillation
- scale length: approximately 2-1/8" (54mm)
- accuracy: 1%
- polyethylene carrying case with clip

Temperature Range	Part #
0°F to 220°F (-18°C to 104°C)	<b>PT220</b>
50°F to 550°F (10°C to 288°C)	<b>PT550</b>

## Magnetic Surface Mount Thermometers

**Features:**

- case: steel, 2" x 1/2"
- dial: polished aluminum
- bi-metal element: responsive actuation by bi-metal helix
- accuracy: ± 2%

Temperature Range	2" Face Part #
0°F to 250°F (-18°C to 121°C)	<b>MT250</b>
0°F to 500°F (-18°C to 260°F)	<b>MT500</b>

## Threaded Thermowells

**Features:**

- 3/4" male NPT process connection

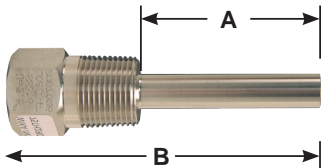

'A' dimension	'B' dimension	316 Stainless Steel Part #
1 5/8"	2 1/2"	<b>75TH2R015SS</b>
2 1/2"	4"	<b>75TH2R025SS</b>
4 1/2"	6"	<b>75TH2R045SS</b>
7 1/2"	9"	<b>75TH2R075SS</b>



## Ball Swivels

## Features:

- brass and hardened steel construction
- O-ring seals
- wobble action for increased flexibility with air driven tools

Hose Size	Male NPT	Part #	Optional Qty
1/4"	1/4"	<b>D444S</b>	25
3/8"	1/4"	<b>D446S</b>	25

Pneumatic  
Accessories

## Push-On Ball Swivels

## Feature:

- special barb design for secure grip in push-on type air hoses

Hose Size	Male NPT	Part #	Optional Qty
3/8"	1/4"	<b>D446SL</b>	25

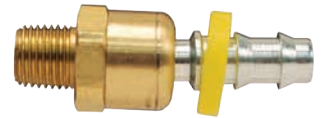

## In-Line Swivels

## Features:

- for air service only
- rated to **250 PSI** at ambient temperature **70°F (21°C)**, minimum **35 PSI**
- heavy-duty, free turning steel swivel



Male NPT	Female NPT	Steel Part #
3/8"	1/2"	<b>SV17</b>
1/2"	1/2"	<b>SV20</b>
3/4"	3/4"	<b>SV26</b>



G

## Features:

- for air service only
- rated to **150 PSI** at ambient temperature **70°F (21°C)**



Male NPT	Female NPT	Brass Part #
1/4"	1/4"	<b>D344R</b>
3/8"	3/8"	<b>D366R</b>

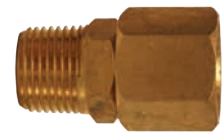

## Air Tool Swivels

## Features:

- swivels at two locations so air hose can drop directly to the floor
- rated to **150 PSI** at ambient temperature **70°F (21°C)**
- do not use with percussion tools



Size	Aluminum Part #
1/4"	<b>D344U<sup>1</sup></b>
3/8"	<b>D346U</b>
1/2"	<b>D348U</b>



<sup>1</sup> D344U is a non-marring composite.



## Conical Mufflers

### Application:

- threads into the exhaust ports of air tool, valves, cylinders and other pneumatic equipment

### Features:

- reduces noise levels below 90 dBA to conform with OSHA standards
- 40 micron bronze filter element
- element is bonded directly to the fitting and *is not replaceable*
- maximum operating pressure: **300 PSI**
- temperature range: **35°F to 300°F (2°C to 149°C)**

NPT Thread	Overall Length	Nickel Plated Steel Part #
1/8"	1 1/8"	<b>CMF18</b>
1/4"	1 3/8"	<b>CMF28</b>
3/8"	1 1/2"	<b>CMF38</b>
1/2"	1 7/8"	<b>CMF48</b>
3/4"	2 1/4"	<b>CMF68</b>
1"	2 7/8"	<b>CMF88</b>

## Speed Control Mufflers

### Features:

- maximum operating pressure: **300 PSI**
- temperature range: **35°F to 300°F (2°C to 149°C)**
- safe and infinite variations of metering air flow at acceptable sound levels on exhaust ports of air valves
- speed of operating cylinder or air tool may be increased or decreased with adjusting screw, the final position is locked in place by the lock nut
- exhaust air noise is eliminated by a surrounding sleeve of sintered bronze



aluminum



brass

NPT Thread	Approximate Full Oper. Height	Maximum Adjusted SCFM	Brass Part #
1/8"	1-5/16"	20	<b>SCM18</b>
1/4"	1-9/16"	30	<b>SCM28</b>
3/8"	1 5/8"	40	<b>SCM38</b>
1/2"	2"	60	<b>SCM48</b>
3/4"	2 3/8"	70	<b>SCM68</b>
1"	2 1/2"	100	<b>SCM88</b>

## Breather Vents

### Applications:

- used on single acting cylinders or valves to prevent dirt and foreign particles from entering ports open to the atmosphere
- provides vacuum relief or pressure equalization on gear boxes, oil tanks or reservoirs

### Features:

- standard pipe thread connections for quick assembly and removal for cleaning
- nickel plated steel insert with a bronze filter
- 40 micron filter element
- maximum operating pressure: **150 PSI**
- temperature range: **35°F to 300°F (2°C to 148°C)**



NPT Thread	Overall Length	Nickel Plated Steel Part #
1/8"	7/16"	<b>ASP-1BV</b>
1/4"	5/8"	<b>ASP-2BV</b>
3/8"	3/4"	<b>ASP-3BV</b>
1/2"	7/8"	<b>ASP-4BV</b>
3/4"	1"	<b>ASP-6BV</b>
1"	1-5/16"	<b>ASP-8BV</b>

Quick Disconnects.....	450 to 505	Adapters (cont.).....	506 to 526
H-series.....	450 to 456	JIC (cont.).....	511 to 517
H-BOP series.....	457	Sleeves.....	515
HS-series.....	458	Straight weld end metal hose fittings.....	517
K-series.....	459 to 460	45° elbow weld end metal hose fittings.....	517
AG-series.....	461 to 462	90° elbow weld end metal hose fittings.....	517
V-series.....	463 to 471	NPTF.....	518 to 522
TR-series.....	472 to 475	Pipe nipples.....	518
HT-series.....	476	Hex reducer bushings.....	518
HTE-series.....	477	Swivels.....	519
HTZ-series.....	478	Swivel nuts.....	519
ST-series.....	479 to 481	Hex pipe couplings.....	519
PD-series.....	482	90° elbows.....	519 to 520
VEP-series.....	483 to 485	90° elbow swivels.....	520
VEP-BOP series.....	486	45° elbows.....	520
W-series.....	487 to 489	Tees.....	521
WS-series.....	490 to 492	Hex caps.....	522
WS-BOP series.....	493	Hex plugs.....	522
T-series.....	494 to 495	Metric parallel thread.....	523
CVV-series.....	496 to 497	BSPP (British Standard Pipe Parallel).....	523
E-series.....	498 to 500	Code 61 / 62 flanges.....	524 to 526
EA-series.....	501	4-bolt NPTF ports.....	524
CM-series.....	502 to 505	4-bolt SAE ports.....	524
		4-bolt flange pipe socket welds.....	525
Adapters.....	506 to 526	Split flange kits.....	526
Flat Face.....	506 to 507	Straight SAE.....	526
Unions.....	506	90° SAE elbows.....	526
Connectors.....	506	45° SAE elbows.....	526
90° elbows.....	506-507		
Tees.....	507	Hydraulic Hose Fittings.....	527 to 528
Caps.....	507	Suction and return line couplings.....	527
Plugs.....	507	Double bolt clamps.....	527
ORB.....	508 to 510	Stems.....	528
Reducers.....	508	Clamps for 1 or 2 wire.....	528
Unions.....	508	Inline hydraulic filters.....	528
O-ring Boss.....	508 to 509		
Elbows.....	509 to 510	Pipe and Tubing Hangers.....	529 to 530
Tees.....	510	Standard series.....	529
Plugs.....	510	Twin series.....	529
37° JIC.....	511 to 517	Heavy duty series.....	530
Flare.....	511		
Swivels.....	512		
90° elbows.....	512		
90° flare elbows.....	512		
45° elbows.....	513 to 514		
Flare unions.....	514		
Flare tees.....	514		
Caps.....	515		
Nuts.....	515 to 516		
Plugs.....	515		

## H-Series Hydraulic Couplings

## Features:

- poppet style shut-off valves in both coupler and plug
- meets dimensional requirements of **ISO 7241 Series B**
- interchangeable with Parker-Hannifin 60 series, see Hydraulic Profile Chart on page 454
- Nitrile seals standard providing temperature range of **-40°F to 250°F (-40°C to 121°C)**
- contact Dixon® for pressure ratings and other technical information
- contact Dixon® for additional seal material options

## ISO-B Female Threaded Couplers



steel



brass

Body Size	Threads	Steel		Brass	
		Previous Part #	Part #	Previous Part #	Part #
1/8"	1/8" - 27 NPTF	---	<b>1HF1</b>	---	<b>1HF1-B</b>
	7/16" - 20 ORB	---	<b>1HOF2</b>	---	---
1/4"	1/4" - 18 NPTF	16-263	<b>2HF2</b>	B16-263	<b>2HF2-B</b>
	1/4" - 19 BSPP	---	<b>2HBF2</b>	---	<b>2HBF2-B</b>
	9/16" - 18 ORB	---	<b>2HOF3</b>	---	---
3/8"	3/8" - 18 NPTF	16-363	<b>3HF3</b>	B16-363	<b>3HF3-B</b>
	3/8" - 19 BSPP	---	<b>3HBF3</b>	---	<b>3HBF3-B</b>
	3/4" - 16 ORB	---	<b>3HOF4</b>	---	---
	1/2" - 14 NPTF	16-463	<b>4HF4</b>	B16-463	<b>4HF4-B</b>
1/2"	1/2" - 14 BSPP	---	<b>4HBF4</b>	---	<b>4HBF4-B</b>
	7/8" - 14 ORB	---	<b>4HOF5</b>	---	---
	3/4" - 14 NPTF	16-663	<b>6HF6</b>	B16-663	<b>6HF6-B</b>
3/4"	3/4" - 14 BSPP	---	<b>6HBF6</b>	---	<b>6HBF6-B</b>
	1-1/16" - 12 ORB	---	<b>6HOF6</b>	---	---
	1" - 11 1/2 NPTF	16-863	<b>8HF8</b>	B16-863	<b>8HF8-B</b>
1"	1" - 11 BSPP	---	<b>8HBF8</b>	---	<b>8HBF8-B</b>
	1-5/16" - 12 ORB	---	<b>8HOF8</b>	---	---



303 stainless

Body Size	Threads	Previous Part #	303 Stainless Steel	316 Stainless Steel
			Part #	Part #
1/8"	1/8" - 27 NPTF	---	<b>1HF1-S</b>	<b>1HF1-SS</b>
1/4"	1/4" - 18 NPTF	SS16-263	<b>2HF2-S</b>	<b>2HF2-SS</b>
	1/4" - 19 BSPP	---	<b>2HBF2-S</b>	<b>2HBF2-SS</b>
3/8"	3/8" - 18 NPTF	SS16-363	<b>3HF3-S</b>	<b>3HF3-SS</b>
	3/8" - 19 BSPP	---	<b>3HBF3-S</b>	<b>3HBF3-SS</b>
1/2"	1/2" - 14 NPTF	SS16-463	<b>4HF4-S</b>	<b>4HF4-SS</b>
	1/2" - 14 BSPP	---	<b>4HBF4-S</b>	<b>4HBF4-SS</b>
3/4"	3/4" - 14 NPTF	SS16-663	<b>6HF6-S</b>	<b>6HF6-SS</b>
	3/4" - 14 BSPP	---	<b>6HBF6-S</b>	<b>6HBF6-SS</b>
1"	1" - 11 1/2 NPTF	SS16-863	<b>8HF8-S</b>	<b>8HF8-SS</b>
	1" - 11 BSPP	---	<b>8HBF8-S</b>	<b>8HBF8-SS</b>

H-Series Hydraulic Couplings

ISO-B Female Threaded Plugs

Hydraulic Fittings

Body Size	Threads	Steel		Brass	
		Previous Part #	Part #	Previous Part #	Part #
1/8"	1/8" - 27 NPTF	---	<b>H1F1</b>	---	<b>H1F1-B</b>
	7/16" - 20 ORB	---	<b>H1OF2</b>	---	---
1/4"	1/4" - 18 NPTF	17-263	<b>H2F2</b>	B17-263	<b>H2F2-B</b>
	1/4" - 19 BSPP	---	<b>H2BF2</b>	---	<b>H2BF2-B</b>
	9/16" - 18 ORB	---	<b>H2OF3</b>	---	---
3/8"	3/8" - 18 NPTF	17-363	<b>H3F3</b>	B17-363	<b>H3F3-B</b>
	3/8" - 19 BSPP	---	<b>H3BF3</b>	---	<b>H3BF3-B</b>
	3/4" - 16 ORB	---	<b>H3OF4</b>	---	---
1/2"	1/2" - 14 NPTF	17-463	<b>H4F4</b>	B17-463	<b>H4F4-B</b>
	1/2" - 14 BSPP	---	<b>H4BF4</b>	---	<b>H4BF4-B</b>
	7/8" - 14 ORB	---	<b>H4OF5</b>	---	---
3/4"	3/4" - 14 NPTF	17-663	<b>H6F6</b>	B17-663	<b>H6F6-B</b>
	3/4" - 14 BSPP	---	<b>H6BF6</b>	---	<b>H6BF6-B</b>
	1-1/16" - 12 ORB	---	<b>H6OF6</b>	---	---
1"	1" - 11 1/2 NPTF	17-863	<b>H8F8</b>	B17-863	<b>H8F8-B</b>
	1" - 11 BSPP	---	<b>H8BF8</b>	---	<b>H8BF8-B</b>
	1-5/16" - 12 ORB	---	<b>H8OF8</b>	---	---



steel



brass

Body Size	Threads	Previous Part #	303 Stainless Steel	316 Stainless Steel
			Part #	Part #
1/8"	1/8" - 27 NPTF	---	<b>H1F1-S</b>	<b>H1F1-SS</b>
1/4"	1/4" - 18 NPTF	SS17-263	<b>H2F2-S</b>	<b>H2F2-SS</b>
	1/4" - 19 BSPP	---	<b>H2BF2-S</b>	<b>H2BF2-SS</b>
3/8"	3/8" - 18 NPTF	SS17-363	<b>H3F3-S</b>	<b>H3F3-SS</b>
	3/8" - 19 BSPP	---	<b>H3BF3-S</b>	<b>H3BF3-SS</b>
1/2"	1/2" - 14 NPTF	SS17-463	<b>H4F4-S</b>	<b>H4F4-SS</b>
	1/2" - 14 BSPP	---	<b>H4BF4-S</b>	<b>H4BF4-SS</b>
3/4"	3/4" - 14 NPTF	SS17-663	<b>H6F6-S</b>	<b>H6F6-SS</b>
	3/4" - 14 BSPP	---	<b>H6BF6-S</b>	<b>H6BF6-SS</b>
1"	1" - 11 1/2 NPTF	SS17-863	<b>H8F8-S</b>	<b>H8F8-SS</b>
	1" - 11 BSPP	---	<b>H8BF8-S</b>	<b>H8BF8-SS</b>

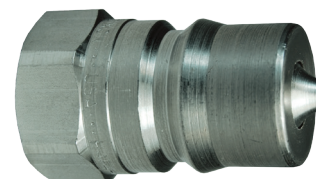

303 stainless



ISO-B Male Threaded Plugs

Body Size	Threads	Steel Part #
1/4"	3/8" - 18 NPTF	<b>H2M3</b>



Body Size	Threads	303 Stainless Steel Part #
1/2"	3/4" - 14 NPTF	<b>H4M6-S</b>



## H-Series Hydraulic Couplings

## ISO-B High Volume Female Threaded Couplers

Hydraulic Fittings



steel



brass



316 stainless

Body Size	Threads	Steel Part #	Brass Part #	303 Stainless Steel Part #	316 Stainless Steel Part #
1¼"	1¼" - 11½ NPTF	<b>10HF10</b>	<b>10HF10-B</b>	<b>10HF10-S</b>	<b>10HF10-SS</b>
	1¼" - 11 BSPP	<b>10HBF10</b>	---	---	<b>10HBF10-SS</b>
1½"	1¼" - 11½ NPTF	<b>12HF10</b>	<b>12HF10-B</b>	<b>12HF10-S</b>	---
	1⅝" - 12 ORB	<b>12HOF10</b>	---	---	---
	1½" - 11½ NPTF	<b>12HF12</b>	<b>12HF12-B</b>	<b>12HF12-S</b>	<b>12HF12-SS</b>
	1½" - 11 BSPP	<b>12HBF12</b>	<b>12HBF12-B</b>	<b>12HBF12-S</b>	<b>12HBF12-SS</b>
2½"	1⅞" - 12 ORB	<b>12HOF12</b>	---	---	---
	2" - 11½ NPTF	<b>20HF16</b>	<b>20HF16-B</b>	---	---
	2½" - 8 NPTF	<b>20HF20</b>	---	---	---
3"	3" - 8 NPTF	<b>20HF24</b>	---	---	---

## ISO-B High Volume Female Threaded Plugs

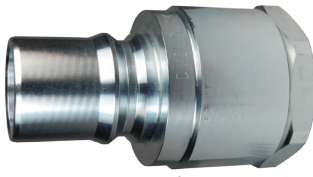

steel



brass



303 stainless

Body Size	Threads	Steel Part #	Brass Part #	303 Stainless Steel Part #	316 Stainless Steel Part #
1¼"	1¼" - 11½ NPTF	<b>H10F10</b>	<b>H10F10-B</b>	<b>H10F10-S</b>	<b>H10F10-SS</b>
	1¼" - 11 BSPP	<b>H10BF10</b>	---	---	<b>H10BF10-SS</b>
1½"	1¼" - 11½ NPTF	<b>H12F10</b>	<b>H12F10-B</b>	<b>H12F10-S</b>	---
	1⅝" - 12 ORB	<b>H12OF10</b>	---	---	---
	1½" - 11½ NPTF	<b>H12F12</b>	<b>H12F12-B</b>	<b>H12F12-S</b>	<b>H12F12-SS</b>
	1½" - 11 BSPP	<b>H12BF12</b>	<b>H12BF12-B</b>	<b>H12BF12-S</b>	<b>H12BF12-SS</b>
2½"	1⅞" - 12 ORB	<b>H12OF12</b>	---	---	---
	2" - 11½ NPTF	<b>H20F16</b>	<b>H20F16-B</b>	---	---
	2½" - 8 NPTF	<b>H20F20</b>	---	---	---
3"	3" - 8 NPTF	<b>H20F24</b>	---	---	---

H-Series Hydraulic Couplings

ISO-B Steel Mill 'Slide Gate' Female Threaded Couplers

Body Size	Female Threads	Steel Part #
1/2"	1/2" - 14 NPTF	<b>4HF4-HV</b>

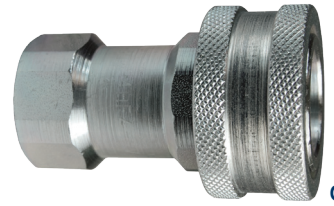

Hydraulic Fittings

ISO-B Steel Mill 'Slide Gate' Female Threaded Plugs

Body Size	Female Threads	Steel Part #
1/2"	1/2" - 14 NPTF	<b>H4F4-HV</b>

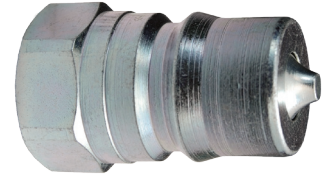

ISO-B Food Grade Silicone Flanged Female Threaded Couplers

Body Size	Female Threads	303 Stainless Steel Part #	316 Stainless Steel Part #
1/2"	1/2" - 14 NPTF	<b>D-4HF4-S-FSB</b>	<b>D-4HF4-SS-FSB</b>

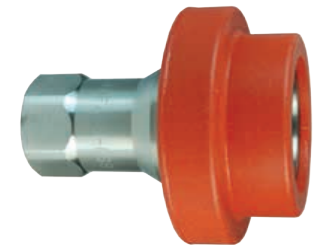

ISO-B Food Grade Nylon Flanged Female Threaded Couplers

Body Size	Female Threads	303 Stainless Steel Part #	316 Stainless Steel Part #
1/2"	1/2" - 14 NPTF	<b>D-4HF4-S-FNS</b>	<b>D-4HF4-SS-FNS</b>

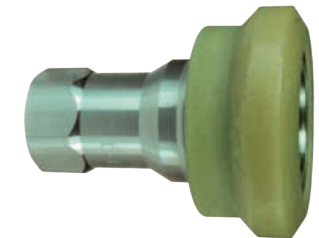

ISO-B Food Grade Female Threaded Plugs

Body Size	Female Threads	Steel Part #	303 Stainless Steel Part #	316 Stainless Steel Part #
1/2"	1/2" - 14 NPTF	<b>D-H4F4-SV-8</b>	<b>D-H4F4-S</b>	<b>D-H4F4-SS</b>

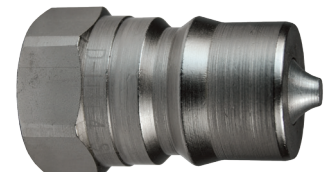

## H-Series Hydraulic Couplings



## ISO-B Dust Caps / Plugs

Body Size	Previous Part #		Nitrile Part #
	Plugs	Caps	
1/8"	VHC002	---	<b>1HDP</b>
1/8"	---	---	<b>H1DC</b>
1/4"	16-002	17-002	<b>2HDP-H2DC</b>
3/8"	16-003	17-003	<b>3HDP-H3DC</b>
1/2"	16-004	17-004	<b>4HDP-H4DC</b>
3/4"	16-006	17-004	<b>6HDP-H6DC</b>
1"	16-008	17-008	<b>8HDP-H8DC</b> <sup>1</sup>

<sup>1</sup> 8HDP-H8DC fits both 1" and 1 1/4" body sizes

## ISO-B Rigid Dust Plugs



Body Size	Previous Part #	Aluminum body with steel cable Part #
1/4"	16-002A	<b>2HDP-A</b>
3/8"	16-003A	<b>3HDP-A</b>
1/2"	16-004A	<b>4HDP-A</b>
3/4"	16-006A	<b>6HDP-A</b>
1"	16-008A	<b>8HDP-A</b>
1 1/2"	---	<b>12HDP-A</b>
2 1/2"	---	<b>20HDP-A</b>

## ISO-B Rigid Dust Caps



Body Size	Previous Part #	Aluminum body with steel cable Part #
1/4"	17-002A	<b>H2DC-A</b>
3/8"	17-003A	<b>H3DC-A</b>
1/2"	17-004A	<b>H4DC-A</b>
3/4"	17-006A	<b>H6DC-A</b>
1"	17-008A	<b>H8DC-A</b>
1 1/2"	---	<b>H12DC-A</b>
2 1/2"	---	<b>H20DC-A</b>

## Plug Profiles

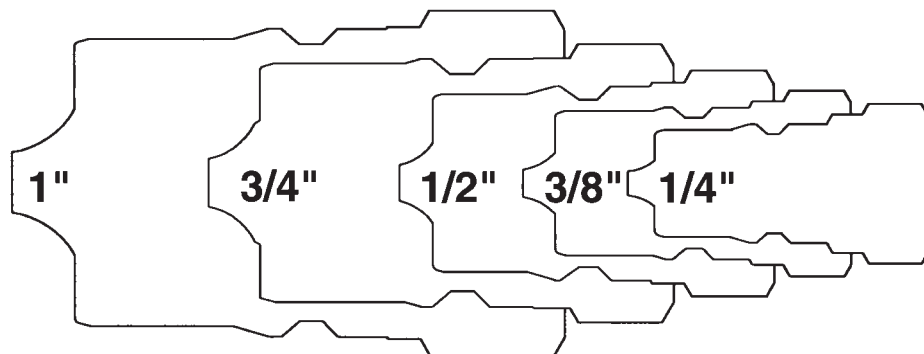

## Industry/Competitor Interchange

ISO 7241-B  
 Hansen HK  
 Eaton/Aeroquip FD45  
 Parker 60  
 Faster HNV  
 Stucchi IRB/IRBO/IRBX



## H-Series Hydraulic Couplings

## ISO-B Coupler Seal Kits

Body Size	Coupler Material	Description	EPDM Part #	FKM Part #	Nitrile Part #
1/8"	brass, steel, 303 SS, 316 SS	two O-rings and one PTFE anti-extrusion ring	<b>P-1H-SKIT</b>	<b>F-1H-SKIT</b>	<b>1H-SKIT</b>
1/4"	brass, steel, 303 SS, 316 SS	two O-rings and one PTFE anti-extrusion ring	<b>P-2H-SKIT</b>	<b>F-2H-SKIT</b>	<b>2H-SKIT</b>
3/8"	brass, steel, 303 SS, 316 SS	two O-rings and one PTFE anti-extrusion ring	<b>P-3H-SKIT</b>	<b>F-3H-SKIT</b>	<b>3H-SKIT</b>
1/2"	brass, steel, 303 SS, 316 SS	two O-rings and one PTFE anti-extrusion ring	<b>P-4H-SKIT</b>	<b>F-4H-SKIT</b>	<b>4H-SKIT</b>
3/4"	brass, steel, 303 SS, 316 SS	two O-rings and one PTFE anti-extrusion ring	<b>P-6H-SKIT</b>	<b>F-6H-SKIT</b>	<b>6H-SKIT</b>
1"	brass, steel, 303 SS, 316 SS	two O-rings and one PTFE anti-extrusion ring	<b>P-8H-SKIT</b>	<b>F-8H-SKIT</b>	<b>8H-SKIT</b>
1 1/4"	brass, steel, 303 SS, 316 SS	adapter / valve O-ring and two body O-rings	<b>P-10H-SKIT</b>	<b>F-10H-SKIT</b>	<b>10H-SKIT</b>
1 1/2"	brass, steel, 303 SS, 316 SS	adapter / valve O-ring and two body O-rings	<b>P-12H-SKIT</b>	<b>F-12H-SKIT</b>	<b>12H-SKIT</b>

## H-Series Hydraulic Couplings

## ISO-B Repair Kits

Hydraulic Fittings

Body Size	Coupler Material	Seal Material	Description	Part #
1/4"	<i>steel</i>	<i>nitrile</i>	steel valve assembly and retaining ring	<b>2H-RKIT</b>
	<i>brass</i>	<i>nitrile</i>	brass valve assembly and retaining ring	<b>2H-BRKIT</b>
	<i>303 stainless</i>	<i>nitrile</i>	303 SS valve assembly and retaining ring	<b>2H-SRKIT</b>
	<i>316 stainless</i>	<i>nitrile</i>	316 SS valve assembly and retaining ring	<b>2H-SSRKIT</b>
3/8"	<i>steel</i>	<i>nitrile</i>	steel valve assembly and retaining ring	<b>3H-RKIT</b>
	<i>brass</i>	<i>nitrile</i>	brass valve assembly and retaining ring	<b>3H-BRKIT</b>
	<i>303 stainless</i>	<i>nitrile</i>	303 SS valve assembly and retaining ring	<b>3H-SRKIT</b>
	<i>316 stainless</i>	<i>nitrile</i>	316 SS valve assembly and retaining ring	<b>3H-SSRKIT</b>
1/2"	<i>steel</i>	<i>nitrile</i>	steel valve assembly and retaining ring	<b>4H-RKIT</b>
	<i>brass</i>	<i>nitrile</i>	brass valve assembly and retaining ring	<b>4H-BRKIT</b>
	<i>303 stainless</i>	<i>nitrile</i>	303 SS valve assembly and retaining ring	<b>4H-SRKIT</b>
	<i>316 stainless</i>	<i>nitrile</i>	316 SS valve assembly and retaining ring	<b>4H-SSRKIT</b>
3/4"	<i>steel</i>	<i>nitrile</i>	steel valve assembly and retaining ring	<b>6H-RKIT</b>
	<i>brass</i>	<i>nitrile</i>	brass valve assembly and retaining ring	<b>6H-BRKIT</b>
	<i>303 stainless</i>	<i>nitrile</i>	303 SS valve assembly and retaining ring	<b>6H-SRKIT</b>
	<i>316 stainless</i>	<i>nitrile</i>	316 SS valve assembly and retaining ring	<b>6H-SSRKIT</b>
1"	<i>steel</i>	<i>nitrile</i>	steel valve assembly and retaining ring	<b>8H-RKIT</b>
	<i>brass</i>	<i>nitrile</i>	brass valve assembly and retaining ring	<b>8H-BRKIT</b>
	<i>303 stainless</i>	<i>nitrile</i>	303 SS valve assembly and retaining ring	<b>8H-SRKIT</b>
	<i>316 stainless</i>	<i>nitrile</i>	316 SS valve assembly and retaining ring	<b>8H-SSRKIT</b>
1 1/4"	<i>steel</i>	<i>nitrile</i>	steel valve assembly and adapter O-ring	<b>10H-RKIT</b>
	<i>brass</i>	<i>nitrile</i>	brass valve assembly and adapter O-ring	<b>10H-BRKIT</b>
	<i>303 stainless</i>	<i>nitrile</i>	303 SS valve assembly and adapter O-ring	<b>10H-SRKIT</b>
	<i>316 stainless</i>	<i>nitrile</i>	316 SS valve assembly and adapter O-ring	<b>10H-SSRKIT</b>
1 1/2"	<i>steel</i>	<i>nitrile</i>	steel valve assembly and adapter O-ring	<b>12H-RKIT</b>
	<i>brass</i>	<i>nitrile</i>	brass valve assembly and adapter O-ring	<b>12H-BRKIT</b>
	<i>303 stainless</i>	<i>nitrile</i>	303 SS valve assembly and adapter O-ring	<b>12H-SRKIT</b>
	<i>316 stainless</i>	<i>nitrile</i>	316 SS valve assembly and adapter O-ring	<b>12H-SSRKIT</b>

## H-BOP Series Hydraulic Couplings

**Application:**

- designed specifically for blow-out preventer systems on drilling rigs

**Features:**

- fire tested and Lloyd's certified to **1300°F (700°C)** in accordance with API 16D; certificate available upon request
- pressure rating **5000 PSI at 70°F (21°C)**
- steel coupler sleeves are hardened to resist deformation and maximize service life
- individually marked with the BOP series designation
- interchangeable with ISO7241 Series B, Eaton/Hansen HKFR-Series, DNP HNV-BOP Series

**Blowout Preventer Safety Female Couplers**

Body Size	Female Threads	Steel Part #	316 Stainless Steel Part #
3/8"	3/8" - 18 NPTF	<b>3HF3-BOP</b>	<b>3HF3-SS-BOP</b>
1/2"	1/2" - 14 NPTF	<b>4HF4-BOP</b>	<b>4HF4-SS-BOP</b>
3/4"	3/4" - 14 NPTF	<b>6HF6-BOP</b>	<b>6HF6-SS-BOP</b>
1"	1" - 11½ NPTF	<b>8HF8-BOP</b>	<b>8HF8-SS-BOP</b>

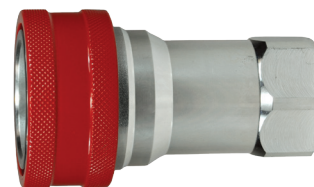
**Blowout Preventer Safety Female Plugs**

Body Size	Female Threads	Steel Part #	316 Stainless Steel Part #
3/8"	3/8" - 18 NPTF	<b>H3F3-BOP</b>	<b>H3F3-SS-BOP</b>
1/2"	1/2" - 14 NPTF	<b>H4F4-BOP</b>	<b>H4F4-SS-BOP</b>
3/4"	3/4" - 14 NPTF	<b>H6F6-BOP</b>	<b>H6F6-SS-BOP</b>
1"	1" - 11½ NPTF	<b>H8F8-BOP</b>	<b>H8F8-SS-BOP</b>



## HS-Series Hydraulic Couplings

**Applications:**

- designed exclusively for steam applications

**Features:**

- coupler has a large plated steel sleeve designed for easier gripping with gloves
- special high-temp EPDM O-rings designed for steam service providing a temperature range of -70°F to 400°F (-57°C to 204°C)
- rated to 200 PSI gauge saturated steam 382°F (194°C)



**Warning: Do Not Disconnect Under Pressure!**

## ISO-B Steam Interchange Female Threaded Couplers



Body Size	Threads	Brass		303 Stainless Steel Part #
		Previous Part #	Part #	
1/4"	1/4" - 18 NPTF	B16-200S	<b>2HSF2-B</b>	<b>2HSF2-S</b>
	1/4" - 19 BSPP	---	<b>2HSBF2-B</b>	<b>2HSBF2-S</b>
3/8"	3/8" - 18 NPTF	B16-300S	<b>3HSF3-B</b>	<b>3HSF3-S</b>
	3/8" - 19 BSPP	---	<b>3HSBF3-B</b>	<b>3HSBF3-S</b>
1/2"	1/2" - 14 NPTF	B16-400S	<b>4HSF4-B</b>	<b>4HSF4-S</b>
	1/2" - 14 BSPP	---	<b>4HSBF4-B</b>	<b>4HSBF4-S</b>
3/4"	3/4" - 14 NPTF	B16-600S	<b>6HSF6-B</b>	<b>6HSF6-S</b>
	3/4" - 14 BSPP	---	<b>6HSBF6-B</b>	<b>6HSBF6-S</b>
1"	1" - 11 1/2 NPTF	B16-800S	<b>8HSF8-B</b>	<b>8HSF8-S</b>
	1" - 11 BSPP	---	<b>8HSBF8-B</b>	<b>8HSBF8-S</b>
1 1/2"	1 1/2" - 11 1/2 NPTF	B16-1200S	<b>PS-12HF12-B</b>	---

## ISO-B Steam Interchange Female Threaded Plugs

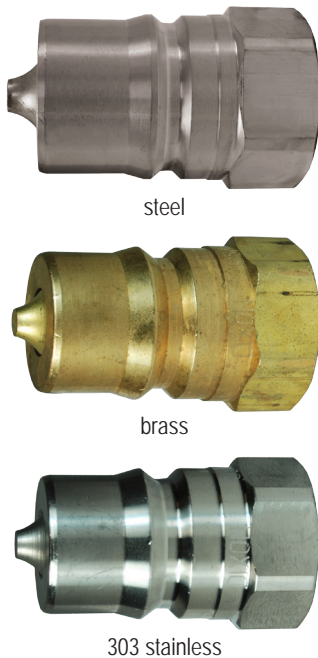

Body Size	Threads	Steel Part #	Brass		303 Stainless Steel Part #
			Previous Part #	Part #	
1/4"	1/4" - 18 NPTF	<b>HS2F2</b>	B17-200S	<b>HS2F2-B</b>	<b>HS2F2-S</b>
	1/4" - 19 BSPP	<b>HS2BF2</b>	---	<b>HS2BF2-B</b>	<b>HS2BF2-S</b>
3/8"	3/8" - 18 NPTF	<b>HS3F3</b>	B17-300S	<b>HS3F3-B</b>	<b>HS3F3-S</b>
	3/8" - 19 BSPP	<b>HS3BF3</b>	---	<b>HS3BF3-B</b>	<b>HS3BF3-S</b>
1/2"	1/2" - 14 NPTF	<b>HS4F4</b>	B17-400S	<b>HS4F4-B</b>	<b>HS4F4-S</b>
	1/2" - 14 BSPP	<b>HS4BF4</b>	---	<b>HS4BF4-B</b>	<b>HS4BF4-S</b>
3/4"	3/4" - 14 NPTF	<b>HS6F6</b>	B17-600S	<b>HS6F6-B</b>	<b>HS6F6-S</b>
	3/4" - 14 BSPP	<b>HS6BF6</b>	---	<b>HS6BF6-B</b>	<b>HS6BF6-S</b>
1"	1" - 11 1/2 NPTF	<b>HS8F8</b>	B17-800S	<b>HS8F8-B</b>	<b>HS8F8-S</b>
	1" - 11 BSPP	<b>HS8BF8</b>	---	<b>HS8BF8-B</b>	<b>HS8BF8-S</b>
1 1/2"	1 1/2" - 11 1/2 NPTF	---	B17-1200S	<b>PS-H12F12-B</b>	---

## K-Series Hydraulic Couplings

## Features:

- poppet style shut-off valves in both coupler and plug
- interchangeable with Aeroquip/Eaton FD56 (5600), Parker 6600, and **ISO-A 7241 interchange**, see Hydraulic Profile Chart on page 460
- nitrile (Buna-N) seal standard, providing a temperature range of **-40°F to 250°F (-40°C to 121°C)**
- Contact Dixon® for additional seal material options, pressure ratings and other technical information.

## ISO-A Interchange Female Threaded Couplers

Body Size	Threads	Previous Part #	Steel Part #	316 Stainless Steel Part #
1/4"	1/8" - 27 NPTF	56-100	<b>2KF1</b>	---
	1/4" - 18 NPTF	56-200	<b>2KF2</b>	<b>2KF2-SS</b>
	1/4" - 19 BSPP	---	<b>2KBF2</b>	<b>2KBF2-SS</b>
	7/16" - 20 ORB	---	<b>2KOF2</b>	---
3/8"	3/8" - 18 NPTF	56-300	<b>3KF3</b>	<b>3KF3-SS</b>
	3/8" - 19 BSPP	---	<b>3KBF3</b>	<b>3KBF3-SS</b>
	9/16" - 18 ORB	---	<b>3KOF3</b>	---
1/2"	1/2" - 14 NPTF	56-400	<b>4KF4</b>	<b>4KF4-SS</b>
	1/2" - 14 BSPP	---	<b>4KBF4</b>	<b>4KBF4-SS</b>
	3/4" - 16 ORB	---	<b>4KOF4</b>	---
	7/8" - 14 ORB	---	<b>4KOF5</b>	---
	3/4" - 14 NPTF	56-600	<b>4KF6</b>	---
3/4"	3/4" - 14 NPTF	56-660	<b>6KF6</b>	<b>6KF6-SS</b>
	3/4" - 14 BSPP	---	<b>6KBF6</b>	<b>6KBF6-SS</b>
1"	1-1/16" - 12 ORB	---	<b>6KOF6</b>	---
	1" - 11 1/2 NPTF	56-800	<b>8KF8</b>	<b>8KF8-SS</b>
	1" - 11 BSPP	---	<b>8KBF8</b>	<b>8KBF8-SS</b>
1 1/4"	1-5/16" - 12 ORB	---	<b>8KOF8</b>	---
	1 1/4" - 11 1/2 NPT	---	<b>10KF10</b>	---
1 1/2"	1 1/4" - 11 BSPP	---	<b>10KBF10</b>	---
	1 1/2" - 11 1/2 NPT	---	<b>12KF12</b>	---
2"	1 1/2" - 11 BSPP	---	<b>12KBF12</b>	---
	2" - 11 1/2 NPT	---	<b>16KF16</b>	---
2"	2" - 11 BSPP	---	<b>16KBF16</b>	---



4KF4 - steel



6KF6 - steel



10KF10 - steel

## ISO-A Interchange Female Threaded Plugs

Body Size	Threads	Previous Part #	Steel Part #	316 Stainless Steel Part #
1/4"	1/8" - 27 NPTF	57-100	<b>K2F1</b>	---
	1/4" - 18 NPTF	57-200	<b>K2F2</b>	<b>K2F2-SS</b>
	1/4" - 19 BSPP	---	<b>K2BF2</b>	<b>K2BF2-SS</b>
	7/16" - 20 ORB	---	<b>K2OF2</b>	---
3/8"	3/8" - 18 NPTF	57-300	<b>K3F3</b>	<b>K3F3-SS</b>
	3/8" - 19 BSPP	---	<b>K3BF3</b>	<b>K3BF3-SS</b>
	9/16" - 18 ORB	---	<b>K3OF3</b>	---
1/2"	1/2" - 14 NPTF	57-400	<b>K4F4</b>	<b>K4F4-SS</b>
	1/2" - 14 BSPP	---	<b>K4BF4</b>	<b>K4BF4-SS</b>
	3/4" - 16 ORB	---	<b>K4OF4</b>	---
	7/8" - 14 ORB	---	<b>K4OF5</b>	---
	3/4" - 14 NPTF	57-600	<b>K4F6</b>	---
3/4"	3/4" - 14 NPTF	57-660	<b>K6F6</b>	<b>K6F6-SS</b>
	3/4" - 14 BSPP	---	<b>K6BF6</b>	<b>K6BF6-SS</b>
1"	1-1/16" - 12 ORB	---	<b>K6OF6</b>	---
	1" - 11 1/2 NPTF	57-800	<b>K8F8</b>	<b>K8F8-SS</b>
	1" - 11 BSPP	---	<b>K8BF8</b>	<b>K8BF8-SS</b>
1 1/4"	1-5/16" - 12 ORB	---	<b>K8OF8</b>	---
	1 1/4" - 11 1/2 NPT	---	<b>K10F10</b>	---
1 1/2"	1 1/4" - 11 BSPP	---	<b>K10BF10</b>	---
	1 1/2" - 11 1/2 NPT	---	<b>K12F12</b>	---
2"	1 1/2" - 11 BSPP	---	<b>K12BF12</b>	---
	2" - 11 1/2 NPT	---	<b>K16F16</b>	---
2"	2" - 11 BSPP	---	<b>K16BF16</b>	---

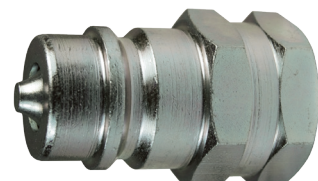

K4F4 - steel



K6F6 - steel

K-Series Hydraulic Couplings

Hydraulic Fittings

ISO-A Interchange Dust Caps / Plugs

Body Size	Previous Part #	Nitrile Part #
1/4"	56-002 / 57-002	<b>2KDP-K2DC</b>
3/8"	56-003 / 57-003 / VHCN004	<b>3KDP-K3DC</b>
3/4"	56-006 / 57-006	<b>6KDP-K6DC</b>
1"	56-008 / 57-008	<b>8KDP-K8DC</b>



ISO-A Interchange Color Coded Dust Plugs



Body Size	Color	Previous Part #	Nitrile Part #
1/2"	black	56-004	<b>4KDP</b>
	red	---	<b>4K-R-DP</b>
	orange	---	<b>4K-O-DP</b>
	yellow	---	<b>4K-Y-DP</b>
	green	---	<b>4K-G-DP</b>
	blue	---	<b>4K-B-DP</b>

ISO-A Interchange Color Coded Dust Caps



Body Size	Color	Previous Part #	Nitrile Part #
1/2"	black	57-004	<b>K4DC</b>
	red	---	<b>K4-R-DC</b>
	orange	---	<b>K4-O-DC</b>
	yellow	---	<b>K4-Y-DC</b>
	green	---	<b>K4-G-DC</b>
	blue	---	<b>K4-B-DC</b>

ISO-A Interchange Coupler Seal Kits

Body Size	Coupler Style	Description	Nitrile Part #
1/4"	all	O-ring and PTFE anti-extrusion ring	<b>2K-SKIT</b>
3/8"	all	O-ring and PTFE anti-extrusion ring	<b>3K-SKIT</b>
1/2"	all	O-ring and PTFE anti-extrusion ring	<b>4K-SKIT</b>
3/4"	all	O-ring and PTFE anti-extrusion ring	<b>6K-SKIT</b>
1"	all	O-ring and PTFE anti-extrusion ring	<b>8K-SKIT</b>
1 1/4"	all	O-ring and PTFE anti-extrusion ring	<b>10K-SKIT</b>
1 1/2"	all	O-ring and PTFE anti-extrusion ring	<b>12K-SKIT</b>
2"	all	O-ring and PTFE anti-extrusion ring	<b>16K-SKIT</b>

Plug Profiles

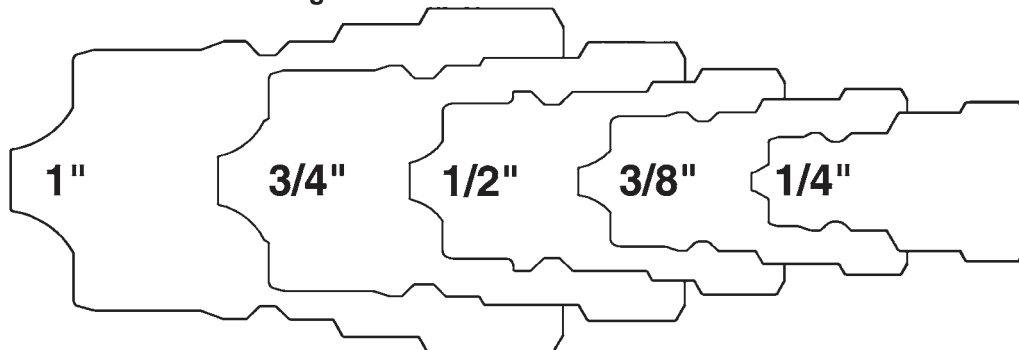

Industry/Competitor Interchange

ISO 7241-A  
 Eaton/Aeroquip 5600  
 Parker 6600  
 Faster ANV  
 Safeway S56  
 Stucchi BIR

## AG-Series Hydraulic Couplings

**Application:**

- used on construction equipment, farm implements and most other mobile equipment

**Features:**

- ball valve and poppet valve options available
- interchangeable with Pioneer 4000 series, see Hydraulic Profile Chart on page 462
- nitrile (Buna-N) seal standard, providing a temperature range of **-40°F to 250°F (-40°C to 121°C)**
- Contact Dixon® for pressure ratings and other technical information.

**Agricultural Ball Valve Female Threaded Couplers**

Body Size	Threads	Steel	
		Previous Part #	Part #
1/4"	1/4" - 18 NPTF	---	<b>2AGF2</b>
3/8"	3/8" - 18 NPTF	---	<b>3AGF3</b>
1/2"	1/2" - 14 NPTF	18-400	<b>4AGF4</b>
	1/2" - 14 BSPP	---	<b>4AGBF4</b>
	3/4" - 16 ORB	18-415	<b>4AGOF4</b>
	7/8" - 14 ORB	---	<b>4AGOF5</b>
3/4"	3/4" - 14 NPTF	18-600	<b>4AGF6</b>
	3/4" - 14 NPTF	18-660	<b>6AGF6</b>
1"	1" - 11 1/2 NPTF	---	<b>8AGF8</b>

**Agricultural Poppet Valve Female Threaded Couplers**

Body Size	Threads	Steel	
		Previous Part #	Part #
1/4"	1/4" - 18 NPTF	18-200	<b>2AGF2-PV</b>
3/8"	3/8" - 18 NPTF	18-300	<b>3AGF3-PV</b>
1/2"	1/2" - 14 NPTF	---	<b>4AGF4-PV</b>
	1/2" - 14 BSPP	---	<b>4AGBF4-PV</b>
	3/4" - 16 ORB	---	<b>4AGOF4-PV</b>
	7/8" - 14 ORB	---	<b>4AGOF5-PV</b>
	3/4" - 14 NPTF	---	<b>4AGF6-PV</b>
3/4"	3/4" - 14 NPTF	---	<b>6AGF6-PV</b>
1"	1" - 11 1/2 NPTF	18-800	<b>8AGF8-PV</b>

**Agricultural Push-Pull Ball Valve Female Threaded Couplers**

Body Size	Threads	Steel
		Part #
3/8"	3/8" - 18 NPTF	<b>3AGF3-PS</b>
	1/2" - 14 NPTF	<b>4AGF4-PS</b>
1/2"	3/4" - 16 ORB	<b>4AGOF4-PS</b>
	7/8" - 14 ORB	<b>4AGOF5-PS</b>
	3/4" - 14 NPTF	<b>4AGF6-PS</b>
3/4"	3/4" - 14 NPTF	<b>6AGF6-PS</b>

**Agricultural Push-Pull Poppet Valve Female Threaded Couplers**

Body Size	Threads	Steel
		Part #
3/8"	3/8" - 18 NPTF	<b>3AGF3-PV-PS</b>
	1/2" - 14 NPTF	<b>4AGF4-PV-PS</b>
1/2"	3/4" - 16 ORB	<b>4AGOF4-PV-PS</b>
	7/8" - 14 ORB	<b>4AGOF5-PV-PS</b>
	3/4" - 14 NPTF	<b>4AGF6-PV-PS</b>
3/4"	3/4" - 14 NPTF	<b>6AGF6-PV-PS</b>



AG-Series Hydraulic Couplings

Hydraulic Fittings



Agricultural Ball Valve Female Threaded Plugs

Body Size	Threads	Steel	
		Previous Part #	Part #
1/4"	1/4" - 18 NPTF	---	<b>AG2F2</b>
3/8"	3/8" - 18 NPTF	---	<b>AG3F3</b>
1/2"	1/2" - 14 NPTF	19-400	<b>AG4F4</b>
	1/2" - 14 BSPP	---	<b>AG4BF4</b>
	3/4" - 16 ORB	19-415	<b>AG4OF4</b>
	7/8" - 14 ORB	---	<b>AG4OF5</b>
	3/4" - 14 NPTF	19-600	<b>AG4F6</b>
3/4"	3/4" - 14 NPTF	19-660	<b>AG6F6</b>
1"	1" - 11 1/2 NPTF	---	<b>AG8F8</b>

Agricultural Poppet Valve Female Threaded Plugs



Body Size	Threads	Steel	
		Previous Part #	Part #
1/4"	1/4" - 18 NPTF	---	<b>AG2F2-PV</b>
3/8"	3/8" - 18 NPTF	---	<b>AG3F3-PV</b>
1/2"	1/2" - 14 NPTF	19-400	<b>AG4F4-PV</b>
	1/2" - 14 BSPP	---	<b>AG4BF4-PV</b>
	3/4" - 16 ORB	19-415	<b>AG4OF4-PV</b>
	7/8" - 14 ORB	---	<b>AG4OF5-PV</b>
	3/4" - 14 NPTF	19-600	<b>AG4F6-PV</b>
3/4"	3/4" - 14 NPTF	19-660	<b>AG6F6-PV</b>
1"	1" - 11 1/2 NPTF	---	<b>AG8F8-PV</b>

Agricultural Dust Plugs



Body Size	Elastomer	
	Previous Part #	Part #
1/4"	18-002	<b>2AGDP</b>
3/8"	18-003	<b>3AGDP</b>
1/2"	For 1/2" Please refer to the color coded K-Series Dust Plugs on pg. 460	
3/4"	18-006	<b>6AGDP</b>
1"	18-008	<b>8AGDP</b>

Agricultural Dust Caps



Body Size	Elastomer	
	Previous Part #	Part #
1/4"	19-002	<b>AG2DC</b>
3/8"	19-003	<b>AG3DC</b>
1/2"	For 1/2" Please refer to the color coded K-Series Dust Caps on pg. 460	
3/4"	19-006	<b>AG6DC</b>
1"	19-008	<b>AG8DC</b>

Plug Profiles

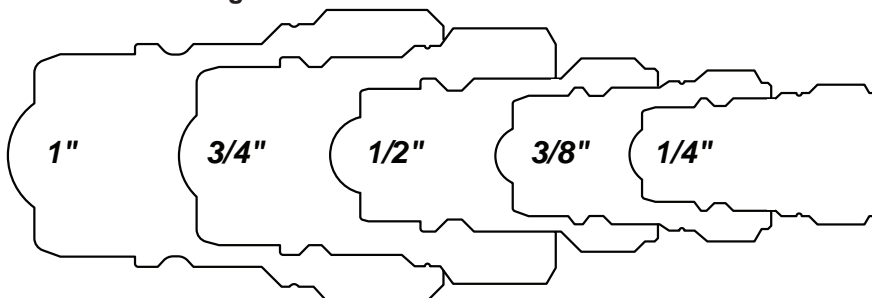

Industry/Competitor Interchange

Parker/Pioneer 4000  
 Safeway S20  
 Faster NS/NV  
 Stucchi IR



## V-Series Hydraulic Couplings

## Features:

- general purpose hydraulic quick-connect provides superior flow characteristics for a variety of applications
- interchangeable with Snap-tite H/H Series, see Hydraulic Profile Chart on page 469
- nitrile seal standard providing a temperature range of **-40°F to 250°F (-40°C to 121°C)**
- Contact Dixon® for additional seal material options.
- Contact Dixon® for pressure ratings and other technical information.

## Snap-Tite H/H Interchange Valved Female Threaded Couplers

Body Size	Threads	Steel		Brass	
		Previous Part #	Part #	Previous Part #	Part #
1/4"	1/8" - 27 NPTF	---	<b>2VF1</b>	---	---
	1/4" - 18 NPTF	VHC200	<b>2VF2</b>	VHC200B	<b>2VF2-B</b>
	1/4" - 19 BSPP	---	<b>2VBF2</b>	---	<b>2VBF2-B</b>
	7/16" - 20 ORB	---	<b>2VOF2</b>	---	---
3/8"	3/8" - 18 NPTF	VHC300	<b>3VF3</b>	VHC300B	<b>3VF3-B</b>
	3/8" - 19 BSPP	---	<b>3VBF3</b>	---	<b>3VBF3-B</b>
	9/16" - 18 ORB	---	<b>3VOF3</b>	---	---
	1/2" - 14 NPTF	---	<b>3VF4</b>	---	---
1/2"	1/2" - 14 NPTF	VHC400	<b>4VF4</b>	VHC400B	<b>4VF4-B</b>
	1/2" - 14 BSPP	---	<b>4VBF4</b>	---	<b>4VBF4-B</b>
	3/4" - 16 ORB	---	<b>4VOF4</b>	---	---
	3/4" - 14 NPTF	---	<b>4VF6</b>	---	---
3/4"	3/4" - 14 NPTF	VHC600	<b>6VF6</b>	VHC600B	<b>6VF6-B</b>
	3/4" - 14 BSPP	---	<b>6VBF6</b>	---	<b>6VBF6-B</b>
	1-1/16" - 12 ORB	---	<b>6VOF6</b>	---	---
1"	1" - 11 1/2 NPTF	VHC800	<b>8VF8</b>	---	<b>8VF8-B</b>
	1" - 11 BSPP	---	<b>8VBF8</b>	---	<b>8VBF8-B</b>
	1-5/16" - 12 ORB	---	<b>8VOF8</b>	---	---
1 1/4"	1 1/4" - 11 1/2 NPTF	VHC1000	<b>10VF10</b>	---	<b>10VF10-B</b>
	1 1/4" - 11 BSPP	---	<b>10VBF10</b>	---	<b>10VBF10-B</b>
	1 5/8" - 12 ORB	---	<b>10VOF10</b>	---	---
1 1/2"	1 1/2" - 11 1/2 NPTF	VHC1200	<b>12VF12</b>	---	<b>12VF12-B</b>
	1 1/2" - 11 BSPP	---	<b>12VBF12</b>	---	<b>12VBF12-B</b>
	1 7/8" - 12 ORB	---	<b>12VOF12</b>	---	---
2"	2" - 11 1/2 NPTF	VHC1600	<b>16VF16</b>	---	<b>16VF16-B</b>
	2" - 11 BSPP	---	<b>16VBF16</b>	---	<b>16VBF16-B</b>

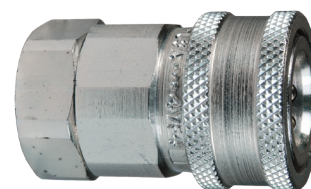

steel

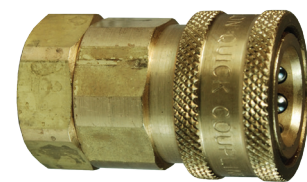

brass

Body Size	Threads	316 Stainless Steel	
		Previous Part #	Part #
1/4"	1/4" - 18 NPTF	VHC200SS	<b>2VF2-SS</b>
	1/4" - 19 BSPP	---	<b>2VBF2-SS</b>
3/8"	3/8" - 18 NPTF	---	<b>3VF3-SS</b>
	3/8" - 19 BSPP	---	<b>3VBF3-SS</b>
1/2"	1/2" - 14 NPTF	VHC400SS	<b>4VF4-SS</b>
	1/2" - 14 BSPP	---	<b>4VBF4-SS</b>
3/4"	3/4" - 14 NPTF	VHC600SS	<b>6VF6-SS</b>
	3/4" - 14 BSPP	---	<b>6VBF6-SS</b>
1"	1" - 11 1/2 NPTF	---	<b>8VF8-SS</b>
	1" - 11 BSPP	---	<b>8VBF8-SS</b>
1 1/4"	1 1/4" - 11 1/2 NPTF	---	<b>10VF10-SS</b>
	1 1/4" - 11 BSPP	---	<b>10VBF10-SS</b>
1 1/2"	1 1/2" - 11 1/2 NPTF	---	<b>12VF12-SS</b>
	1 1/2" - 11 BSPP	---	<b>12VBF12-SS</b>
2"	2" - 11 1/2 NPTF	---	<b>16VF16-SS</b>
	2" - 11 BSPP	---	<b>16VBF16-SS</b>



## V-Series Hydraulic Couplings

### Snap-Tite H/IH Interchange Valved Male Threaded Couplers

Hydraulic Fittings



steel

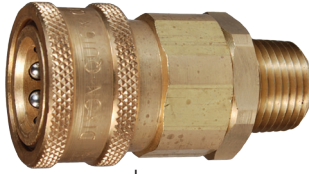

brass



316 stainless



steel - JIC

Body Size	Threads	Steel Part #	Brass Part #	316 Stainless Steel Part #
1/4"	1/8" - 27 NPTF	<b>2VM1</b>	---	---
	1/4" - 18 NPTF	<b>2VM2</b>	<b>2VM2-B</b>	<b>2VM2-SS</b>
	7/16" - 20 JIC	<b>2VJM2</b>	---	---
3/8"	3/8" - 18 NPTF	<b>3VM3</b>	<b>3VM3-B</b>	<b>3VM3-SS</b>
	9/16" - 18 JIC	<b>3VJM3</b>	---	---
1/2"	1/2" - 14 NPTF	<b>4VM4</b>	<b>4VM4-B</b>	<b>4VM4-SS</b>
	3/4" - 16 JIC	<b>4VJM4</b>	---	---
3/4"	3/4" - 14 NPTF	<b>6VM6</b>	<b>6VM6-B</b>	<b>6VM6-SS</b>
	1-1/16" - 12 JIC	<b>6VJM6</b>	---	---
1"	1" - 11 1/2 NPTF	<b>8VM8</b>	<b>8VM8-B</b>	<b>8VM8-SS</b>
	1-5/16" - 12 JIC	<b>8VJM8</b>	---	---
1 1/4"	1 1/4" - 11 1/2 NPTF	<b>10VM10</b>	<b>10VM10-B</b>	<b>10VM10-SS</b>
	1 5/8" - 12 JIC	<b>10VJM10</b>	---	---
1 1/2"	1 1/2" - 11 1/2 NPTF	<b>12VM12</b>	<b>12VM12-B</b>	<b>12VM12-SS</b>
2"	2" - 11 1/2 NPTF	<b>16VM16</b>	<b>16VM16-B</b>	<b>16VM16-SS</b>

### Snap-Tite H/IH Interchange Valved Male Threaded Plugs



steel



brass



316 stainless



steel

Body Size	Threads	Steel Part #	Brass Part #	316 Stainless Steel Part #
1/4"	1/8" - 27 NPTF	<b>V2M1</b>	---	---
	1/4" - 18 NPTF	<b>V2M2</b>	<b>V2M2-B</b>	<b>V2M2-SS</b>
	7/16" - 20 JIC	<b>V2JM2</b>	---	---
3/8"	3/8" - 18 NPTF	<b>V3M3</b>	<b>V3M3-B</b>	<b>V3M3-SS</b>
	9/16" - 18 JIC	<b>V3JM3</b>	---	---
1/2"	1/2" - 14 NPTF	<b>V4M4</b>	<b>V4M4-B</b>	<b>V4M4-SS</b>
	3/4" - 16 JIC	<b>V4JM4</b>	---	---
3/4"	3/4" - 14 NPTF	<b>V6M6</b>	<b>V6M6-B</b>	<b>V6M6-SS</b>
	1-1/16" - 12 JIC	<b>V6JM6</b>	---	---
1"	1" - 11 1/2 NPTF	<b>V8M8</b>	<b>V8M8-B</b>	<b>V8M8-SS</b>
	1-5/16" - 12 JIC	<b>V8JM8</b>	---	---
1 1/4"	1 1/4" - 11 1/2 NPTF	<b>V10M10</b>	<b>V10M10-B</b>	<b>V10M10-SS</b>
	1 5/8" - 12 JIC	<b>V10JM10</b>	---	---
1 1/2"	1 1/2" - 11 1/2 NPTF	<b>V12M12</b>	<b>V12M12-B</b>	<b>V12M12-SS</b>
2"	2" - 11 1/2 NPTF	<b>V16M16</b>	<b>V16M16-B</b>	<b>V16M16-SS</b>

## V-Series Hydraulic Couplings

## Snap-Tite H/IH Interchange Valved Female Threaded Plugs

Body Size	Threads	Steel		Brass	
		Previous Part #	Part #	Previous Part #	Part #
1/4"	1/8" - 27 NPTF	---	<b>V2F1</b>	---	---
	1/4" - 18 NPTF	VHN200	<b>V2F2</b>	VHN200B	<b>V2F2-B</b>
	1/4" - 19 BSPP	---	<b>V2BF2</b>	---	<b>V2BF2-B</b>
	7/16" - 20 ORB	---	<b>V2OF2</b>	---	---
3/8"	3/8" - 18 NPTF	VHN300	<b>V3F3</b>	VHN300B	<b>V3F3-B</b>
	3/8" - 19 BSPP	---	<b>V3BF3</b>	---	<b>V3BF3-B</b>
	9/16" - 18 ORB	---	<b>V3OF3</b>	---	---
	1/2" - 14 NPTF	---	<b>V3F4</b>	---	---
1/2"	1/2" - 14 NPTF	VHN400	<b>V4F4</b>	VHN400B	<b>V4F4-B</b>
	1/2" - 14 BSPP	---	<b>V4BF4</b>	---	<b>V4BF4-B</b>
	3/4" - 16 ORB	---	<b>V4OF4</b>	---	---
	3/4" - 14 NPTF	---	<b>V4F6</b>	---	---
3/4"	3/4" - 14 NPTF	VHN600	<b>V6F6</b>	VHN600B	<b>V6F6-B</b>
	3/4" - 14 BSPP	---	<b>V6BF6</b>	---	<b>V6BF6-B</b>
	1-1/16" - 12 ORB	---	<b>V6OF6</b>	---	---
1"	1" - 11 1/2 NPTF	VHN800	<b>V8F8</b>	---	<b>V8F8-B</b>
	1" - 11 BSPP	---	<b>V8BF8</b>	---	<b>V8BF8-B</b>
	1-5/16" - 12 ORB	---	<b>V8OF8</b>	---	---
1 1/4"	1 1/4" - 11 1/2 NPTF	VHN1000	<b>V10F10</b>	---	<b>V10F10-B</b>
	1 1/4" - 11 BSPP	---	<b>V10BF10</b>	---	<b>V10BF10-B</b>
	1 5/8" - 12 ORB	---	<b>V10OF10</b>	---	---
1 1/2"	1 1/2" - 11 1/2 NPTF	VHN1200	<b>V12F12</b>	---	<b>V12F12-B</b>
	1 1/2" - 11 BSPP	---	<b>V12BF12</b>	---	<b>V12BF12-B</b>
	1 7/8" - 12 ORB	---	<b>V12OF12</b>	---	---
2"	2" - 11 1/2 NPTF	VHN1600	<b>V16F16</b>	---	<b>V16F16-B</b>
	2" - 11 BSPP	---	<b>V16BF16</b>	---	<b>V16BF16-B</b>



steel

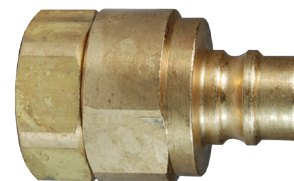

brass

Body Size	Threads	316 Stainless Steel	
		Previous Part #	Part #
1/4"	1/4" - 18 NPTF	VHN200SS	<b>V2F2-SS</b>
	1/4" - 19 BSPP	---	<b>V2BF2-SS</b>
3/8"	3/8" - 18 NPTF	---	<b>V3F3-SS</b>
	3/8" - 19 BSPP	---	<b>V3BF3-SS</b>
1/2"	1/2" - 14 NPTF	VHN400SS	<b>V4F4-SS</b>
	1/2" - 14 BSPP	---	<b>V4BF4-SS</b>
3/4"	3/4" - 14 NPTF	VHN600SS	<b>V6F6-SS</b>
	3/4" - 14 BSPP	---	<b>V6BF6-SS</b>
1"	1" - 11 1/2 NPTF	---	<b>V8F8-SS</b>
	1" - 11 BSPP	---	<b>V8BF8-SS</b>
1 1/4"	1 1/4" - 11 1/2 NPTF	---	<b>V10F10-SS</b>
	1 1/4" - 11 BSPP	---	<b>V10BF10-SS</b>
1 1/2"	1 1/2" - 11 1/2 NPTF	---	<b>V12F12-SS</b>
	1 1/2" - 11 BSPP	---	<b>V12BF12-SS</b>
2"	2" - 11 1/2 NPTF	---	<b>V16F16-SS</b>
	2" - 11 BSPP	---	<b>V16BF16-SS</b>



## V-Series Hydraulic Couplings

## Snap-Tite H/IH Interchange Unvalved Female Threaded Couplers

Hydraulic Fittings



steel



brass

Body Size	Threads	Previous Part #	Steel Part #	Brass Part #
1/4"	1/4" - 18 NPTF	---	<b>2VF2-E</b>	<b>2VF2-B-E</b>
	1/4" - 19 BSPP	---	<b>2VBF2-E</b>	<b>2VBF2-B-E</b>
3/8"	3/8" - 18 NPTF	---	<b>3VF3-E</b>	<b>3VF3-B-E</b>
	3/8" - 19 BSPP	---	<b>3VBF3-E</b>	<b>3VBF3-B-E</b>
1/2"	1/2" - 14 NPTF	VHC400NV	<b>4VF4-E</b>	<b>4VF4-B-E</b>
	1/2" - 14 BSPP	---	<b>4VBF4-E</b>	<b>4VBF4-B-E</b>
3/4"	3/4" - 14 NPTF	VHC600NV	<b>6VF6-E</b>	<b>6VF6-B-E</b>
	3/4" - 14 BSPP	---	<b>6VBF6-E</b>	<b>6VBF6-B-E</b>
1"	1" - 11 1/2 NPTF	---	<b>8VF8-E</b>	<b>8VF8-B-E</b>
	1" - 11 BSPP	---	<b>8VBF8-E</b>	<b>8VBF8-B-E</b>
1 1/4"	1 1/4" - 11 1/2 NPTF	---	<b>10VF10-E</b>	<b>10VF10-B-E</b>
	1 1/4" - 11 BSPP	---	<b>10VBF10-E</b>	<b>10VBF10-B-E</b>
1 1/2"	1 1/2" - 11 1/2 NPTF	---	<b>12VF12-E</b>	<b>12VF12-B-E</b>
2"	2" - 11 1/2 NPTF	---	<b>16VF16-E</b>	<b>16VF16-B-E</b>

Body Size	Threads	316 Stainless Steel Part #
1/4"	1/4" - 18 NPTF	<b>2VF2-SS-E</b>
	1/4" - 19 BSPP	<b>2VBF2-SS-E</b>
3/8"	3/8" - 18 NPTF	<b>3VF3-SS-E</b>
	3/8" - 19 BSPP	<b>3VBF3-SS-E</b>
1/2"	1/2" - 14 NPTF	<b>4VF4-SS-E</b>
	1/2" - 14 BSPP	<b>4VBF4-SS-E</b>
3/4"	3/4" - 14 NPTF	<b>6VF6-SS-E</b>
	3/4" - 14 BSPP	<b>6VBF6-SS-E</b>
1"	1" - 11 1/2 NPTF	<b>8VF8-SS-E</b>
	1" - 11 BSPP	<b>8VBF8-SS-E</b>
1 1/4"	1 1/4" - 11 1/2 NPTF	<b>10VF10-SS-E</b>
	1 1/4" - 11 BSPP	<b>10VBF10-SS-E</b>
1 1/2"	1 1/2" - 11 1/2 NPTF	<b>12VF12-SS-E</b>
2"	2" - 11 1/2 NPTF	<b>16VF16-SS-E</b>



V-Series Hydraulic Couplings

Snap-Tite H/IH Interchange Unvalved Male Threaded Couplers

Hydraulic Fittings

Body Size	Threads	Steel Part #	Brass Part #	316 Stainless Steel Part #
1/4"	1/4" - 18 NPTF	<b>2VM2-E</b>	<b>2VM2-B-E</b>	<b>2VM2-SS-E</b>
3/8"	3/8" - 18 NPTF	<b>3VM3-E</b>	<b>3VM3-B-E</b>	<b>3VM3-SS-E</b>
1/2"	1/2" - 14 NPTF	<b>4VM4-E</b>	<b>4VM4-B-E</b>	<b>4VM4-SS-E</b>
3/4"	3/4" - 14 NPTF	<b>6VM6-E</b>	<b>6VM6-B-E</b>	<b>6VM6-SS-E</b>
1"	1" - 11 1/2 NPTF	<b>8VM8-E</b>	<b>8VM8-B-E</b>	<b>8VM8-SS-E</b>
1 1/4"	1 1/4" - 11 1/2 NPTF	<b>10VM10-E</b>	---	<b>10VM10-SS-E</b>
1 1/2"	1 1/2" - 11 1/2 NPTF	<b>12VM12-E</b>	---	<b>12VM12-SS-E</b>
2"	2" - 11 1/2 NPTF	<b>16VM16-E</b>	---	<b>16VM16-SS-E</b>



steel



brass



316 stainless

Snap-Tite H/IH Interchange Unvalved Male Threaded Plugs

Body Size	Threads	Steel Part #	Brass Part #	316 Stainless Steel Part #
1/4"	1/4" - 18 NPTF	<b>V2M2-E</b>	<b>V2M2-B-E</b>	<b>V2M2-SS-E</b>
3/8"	3/8" - 18 NPTF	<b>V3M3-E</b>	<b>V3M3-B-E</b>	<b>V3M3-SS-E</b>
1/2"	1/2" - 14 NPTF	<b>V4M4-E</b>	<b>V4M4-B-E</b>	<b>V4M4-SS-E</b>
3/4"	3/4" - 14 NPTF	<b>V6M6-E</b>	<b>V6M6-B-E</b>	<b>V6M6-SS-E</b>
1"	1" - 11 1/2 NPTF	<b>V8M8-E</b>	<b>V8M8-B-E</b>	<b>V8M8-SS-E</b>
1 1/4"	1 1/4" - 11 1/2 NPTF	<b>V10M10-E</b>	---	<b>V10M10-SS-E</b>
1 1/2"	1 1/2" - 11 1/2 NPTF	<b>V12M12-E</b>	---	<b>V12M12-SS-E</b>
2"	2" - 11 1/2 NPTF	<b>V16M16-E</b>	---	<b>V16M16-SS-E</b>



steel

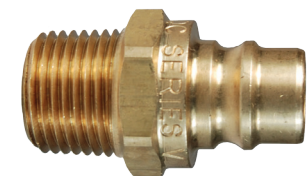

brass

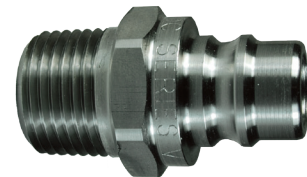

316 stainless

## V-Series Hydraulic Couplings

Hydraulic Fittings

## Snap-Tite H/IH Interchange Unvalved Female Threaded Plugs



steel

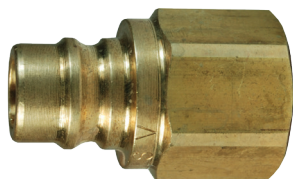

brass

Body Size	Threads	Previous Part #	Steel Part #	Brass Part #
1/4"	1/4" - 18 NPTF	---	<b>V2F2-E</b>	<b>V2F2-B-E</b>
	1/4" - 19 BSPP	---	<b>V2BF2-E</b>	<b>V2BF2-B-E</b>
3/8"	3/8" - 18 NPTF	---	<b>V3F3-E</b>	<b>V3F3-B-E</b>
	3/8" - 19 BSPP	---	<b>V3BF3-E</b>	<b>V3BF3-B-E</b>
1/2"	1/2" - 14 NPTF	VHN400NV	<b>V4F4-E</b>	<b>V4F4-B-E</b>
	1/2" - 14 BSPP	---	<b>V4BF4-E</b>	<b>V4BF4-B-E</b>
3/4"	3/4" - 14 NPTF	VHN600NV	<b>V6F6-E</b>	<b>V6F6-B-E</b>
	3/4" - 14 BSPP	---	<b>V6BF6-E</b>	<b>V6BF6-B-E</b>
1"	1" - 11 1/2 NPTF	---	<b>V8F8-E</b>	<b>V8F8-B-E</b>
	1" - 11 BSPP	---	<b>V8BF8-E</b>	<b>V8BF8-B-E</b>
1 1/4"	1 1/4" - 11 1/2 NPTF	---	<b>V10F10-E</b>	<b>V10F10-B-E</b>
	1 1/4" - 11 BSPP	---	<b>V10BF10-E</b>	<b>V10BF10-B-E</b>
1 1/2"	1 1/2" - 11 1/2 NPTF	---	<b>V12F12-E</b>	<b>V12F12-B-E</b>
	2" - 11 1/2 NPTF	---	<b>V16F16-E</b>	<b>V16F16-B-E</b>

Body Size	Threads	316 Stainless Steel Part #
1/4"	1/4" - 18 NPTF	<b>V2F2-SS-E</b>
	1/4" - 19 BSPP	<b>V2BF2-SS-E</b>
3/8"	3/8" - 18 NPTF	<b>V3F3-SS-E</b>
	3/8" - 19 BSPP	<b>V3BF3-SS-E</b>
1/2"	1/2" - 14 NPTF	<b>V4F4-SS-E</b>
	1/2" - 14 BSPP	<b>V4BF4-SS-E</b>
3/4"	3/4" - 14 NPTF	<b>V6F6-SS-E</b>
	3/4" - 14 BSPP	<b>V6BF6-SS-E</b>
1"	1" - 11 1/2 NPTF	<b>V8F8-SS-E</b>
	1" - 11 BSPP	<b>V8BF8-SS-E</b>
1 1/4"	1 1/4" - 11 1/2 NPTF	<b>V10F10-SS-E</b>
	1 1/4" - 11 BSPP	<b>V10BF10-SS-E</b>
1 1/2"	1 1/2" - 11 1/2 NPTF	<b>V12F12-SS-E</b>
2"	2" - 11 1/2 NPTF	<b>V16F16-SS-E</b>

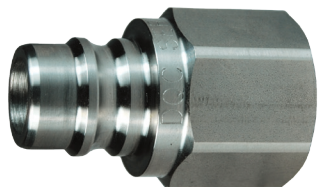

V-Series Hydraulic Couplings

Snap-Tite H/IH Interchange Dust Caps / Plugs

Hydraulic Fittings

Body Size	Nitrile	
	Previous Part #	Part #
1/4"	VHC002	<b>1HDP</b>
1/4"	VHN002	<b>V2DC</b>
3/8"	---	<b>3VDP-V3DC</b>
1/2"	VHCN003	<b>3KDP-K3DC</b>
3/4"	VHCN006	<b>6VDP-V6DC</b>
1"	VHCN008	<b>8VDP-V8DC</b>



Snap-Tite H/IH Interchange Dust Plugs

Body Size	Aluminum body with steel cable	
	Previous Part #	Part #
1/4"	---	<b>2VDP-A</b>
3/8"	---	<b>3VDP-A</b>
1/2"	---	<b>4VDP-A</b>
3/4"	---	<b>6VDP-A</b>
1"	---	<b>8VDP-A</b>
1 1/4"	VHC010	<b>10VDP-A</b>
1 1/2"	VHC012	<b>12VDP-A</b>
2"	VHC016	<b>16VDP-A</b>



Snap-Tite H/IH Interchange Dust Caps

Body Size	Aluminum body with steel cable	
	Previous Part #	Part #
1/4"	---	<b>V2DC-A</b>
3/8"	---	<b>V3DC-A</b>
1/2"	---	<b>V4DC-A</b>
3/4"	---	<b>V6DC-A</b>
1"	---	<b>V8DC-A</b>
1 1/4"	VHN010	<b>V10DC-A</b>
1 1/2"	VHN012	<b>V12DC-A</b>
2"	VHN016	<b>V16DC-A</b>



Plug Profiles

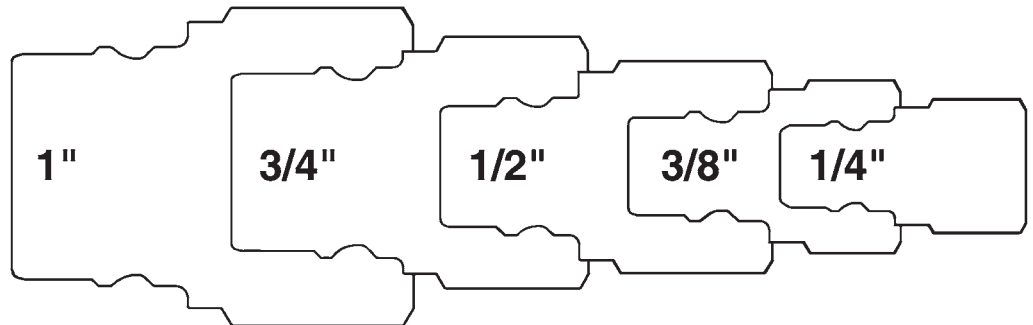

Industry/Competitor Interchange

Snap-tite H  
Faster TNV

## V-Series Hydraulic Couplings

## Snap-Tite H/IH Interchange Coupler Seal Kits

Hydraulic Fittings

Body Size	Coupler Style	Description	Nitrile Part #
1/4"	all	body / adapter O-rings and PTFE back-up	<b>2V-SKIT</b>
3/8"	all	body / adapter O-rings and PTFE back-up	<b>3V-SKIT</b>
1/2"	all	body / adapter O-rings and PTFE back-up	<b>4V-SKIT</b>
3/4"	all	body / adapter O-rings and PTFE back-up	<b>6V-SKIT</b>
1"	all	body / adapter O-rings and PTFE back-up	<b>8V-SKIT</b>
1 1/4"	all	body / adapter/valve O-rings and back-up	<b>10V-SKIT</b>
1 1/2"	all	body / adapter/valve O-rings and back-up	<b>12V-SKIT</b>
2"	all	body / adapter/valve O-rings and back-up	<b>16V-SKIT</b>

Body Size	Coupler Style	Description	FKM Part #
1/4"	all	body / adapter O-rings and PTFE back-up	<b>F-2V-SKIT</b>
3/8"	all	body / adapter O-rings and PTFE back-up	<b>F-3V-SKIT</b>
1/2"	all	body / adapter O-rings and PTFE back-up	<b>F-4V-SKIT</b>
3/4"	all	body / adapter O-rings and PTFE back-up	<b>F-6V-SKIT</b>
1"	all	body / adapter O-rings and PTFE back-up	<b>F-8V-SKIT</b>
1 1/4"	all	body / adapter/valve O-rings and back-up	<b>F-10V-SKIT</b>
1 1/2"	all	body / adapter/valve O-rings and back-up	<b>F-12V-SKIT</b>
2"	all	body / adapter/valve O-rings and back-up	<b>F-16V-SKIT</b>

Body Size	Coupler Style	Description	EPDM Part #
1/4"	all	body / adapter O-rings and PTFE back-up	<b>P-2V-SKIT</b>
3/8"	all	body / adapter O-rings and PTFE back-up	<b>P-3V-SKIT</b>
1/2"	all	body / adapter O-rings and PTFE back-up	<b>P-4V-SKIT</b>
3/4"	all	body / adapter O-rings and PTFE back-up	<b>P-6V-SKIT</b>
1"	all	body / adapter O-rings and PTFE back-up	<b>P-8V-SKIT</b>
1 1/4"	all	body / adapter/valve O-rings and back-up	<b>P-10V-SKIT</b>
1 1/2"	all	body / adapter/valve O-rings and back-up	<b>P-12V-SKIT</b>
2"	all	body / adapter/valve O-rings and back-up	<b>P-16V-SKIT</b>



## V-Series Hydraulic Couplings

## Snap-Tite H/H Interchange Coupler Repair Kits

Body Size	Coupler Material	Seal Material	Description	Part #
¼"	<i>steel</i>	<i>nitrile</i>	steel valve assembly and adapter O-ring	<b>2V-RKIT</b>
	<i>brass</i>	<i>nitrile</i>	brass valve assembly and adapter O-ring	<b>2V-BRKIT</b>
	<i>316 stainless</i>	<i>nitrile</i>	316 SS valve assembly and adapter O-ring	<b>2V-SSRKIT</b>
⅜"	<i>steel</i>	<i>nitrile</i>	steel valve assembly and adapter O-ring	<b>3V-RKIT</b>
	<i>brass</i>	<i>nitrile</i>	brass valve assembly and adapter O-ring	<b>3V-BRKIT</b>
	<i>316 stainless</i>	<i>nitrile</i>	316 SS valve assembly and adapter O-ring	<b>3V-SSRKIT</b>
½"	<i>steel</i>	<i>nitrile</i>	steel valve assembly and adapter O-ring	<b>4V-RKIT</b>
	<i>brass</i>	<i>nitrile</i>	brass valve assembly and adapter O-ring	<b>4V-BRKIT</b>
	<i>316 stainless</i>	<i>nitrile</i>	316 SS valve assembly and adapter O-ring	<b>4V-SSRKIT</b>
¾"	<i>steel</i>	<i>nitrile</i>	steel valve assembly and adapter O-ring	<b>6V-RKIT</b>
	<i>brass</i>	<i>nitrile</i>	brass valve assembly and adapter O-ring	<b>6V-BRKIT</b>
	<i>316 stainless</i>	<i>nitrile</i>	316 SS valve assembly and adapter O-ring	<b>6V-SSRKIT</b>
1"	<i>steel</i>	<i>nitrile</i>	steel valve assembly and adapter O-ring	<b>8V-RKIT</b>
	<i>brass</i>	<i>nitrile</i>	brass valve assembly and adapter O-ring	<b>8V-BRKIT</b>
	<i>316 stainless</i>	<i>nitrile</i>	316 SS valve assembly and adapter O-ring	<b>8V-SSRKIT</b>
1¼"	<i>steel</i>	<i>nitrile</i>	steel valve assembly and adapter O-ring	<b>140030-10</b>
	<i>316 stainless</i>	<i>nitrile</i>	316 SS valve assembly and adapter O-ring	<b>140032-10</b>
1½"	<i>steel</i>	<i>nitrile</i>	steel valve assembly and adapter O-ring	<b>140030-12</b>
	<i>316 stainless</i>	<i>nitrile</i>	316 SS valve assembly and adapter O-ring	<b>140032-12</b>
2"	<i>steel</i>	<i>nitrile</i>	steel valve assembly and adapter O-ring	<b>140030-16</b>
	<i>316 stainless</i>	<i>nitrile</i>	316 SS valve assembly and adapter O-ring	<b>140032-16</b>

## Snap-Tite H/H Interchange Plug Repair Kits

Body Size	Coupler Material	Seal Material	Description	Part #
¼"	<i>steel</i>	<i>nitrile</i>	steel valve assembly and adapter O-ring	<b>V2-RKIT</b>
	<i>brass</i>	<i>nitrile</i>	brass valve assembly and adapter O-ring	<b>V2-BRKIT</b>
	<i>316 stainless</i>	<i>nitrile</i>	316 SS valve assembly and adapter O-ring	<b>V2-SSRKIT</b>
⅜"	<i>steel</i>	<i>nitrile</i>	steel valve assembly and adapter O-ring	<b>V3-RKIT</b>
	<i>brass</i>	<i>nitrile</i>	brass valve assembly and adapter O-ring	<b>V3-BRKIT</b>
	<i>316 stainless</i>	<i>nitrile</i>	316 SS valve assembly and adapter O-ring	<b>V3-SSRKIT</b>
½"	<i>steel</i>	<i>nitrile</i>	steel valve assembly and adapter O-ring	<b>V4-RKIT</b>
	<i>brass</i>	<i>nitrile</i>	brass valve assembly and adapter O-ring	<b>V4-BRKIT</b>
	<i>316 stainless</i>	<i>nitrile</i>	316 SS valve assembly and adapter O-ring	<b>V4-SSRKIT</b>
¾"	<i>steel</i>	<i>nitrile</i>	steel valve assembly and adapter O-ring	<b>V6-RKIT</b>
	<i>brass</i>	<i>nitrile</i>	brass valve assembly and adapter O-ring	<b>V6-BRKIT</b>
	<i>316 stainless</i>	<i>nitrile</i>	316 SS valve assembly and adapter O-ring	<b>V6-SSRKIT</b>
1"	<i>steel</i>	<i>nitrile</i>	steel valve assembly and adapter O-ring	<b>V8-RKIT</b>
	<i>brass</i>	<i>nitrile</i>	brass valve assembly and adapter O-ring	<b>V8-BRKIT</b>
	<i>316 stainless</i>	<i>nitrile</i>	316 SS valve assembly and adapter O-ring	<b>V8-SSRKIT</b>
1¼"	<i>steel</i>	<i>nitrile</i>	steel valve assembly and adapter O-ring	<b>140030-10</b>
	<i>316 stainless</i>	<i>nitrile</i>	316 SS valve assembly and adapter O-ring	<b>140032-10</b>
1½"	<i>steel</i>	<i>nitrile</i>	steel valve assembly and adapter O-ring	<b>140030-12</b>
	<i>316 stainless</i>	<i>nitrile</i>	316 SS valve assembly and adapter O-ring	<b>140032-12</b>
2"	<i>steel</i>	<i>nitrile</i>	steel valve assembly and adapter O-ring	<b>140030-16</b>
	<i>316 stainless</i>	<i>nitrile</i>	316 SS valve assembly and adapter O-ring	<b>140032-16</b>

## TR-Series Hydraulic Couplings

## Features:

- interchangeable with TEMA European, 3800, 5000, 7500, 10000 series
- nitrile (Buna-N) seal standard, providing a temperature range of **-40°F to 250°F (-40°C to 121°C)**
- valve seals are crimped in place to maintain integrity during excessive flow conditions and pressurized connection
- Contact Dixon® for pressure ratings and other technical information.



## Tema European Female Threaded Couplers

Body Size	Threads	Steel Part #
3/8"	3/8" - 18 NPTF	<b>3TRF3</b>
	3/8" - 19 BSPP	<b>3TRBF3</b>
1/2"	1/2" - 14 NPTF	<b>4TRF4</b>
	1/2" - 14 BSPP	<b>4TRBF4</b>
3/4"	3/4" - 14 NPTF	<b>6TRF6</b>
	3/4" - 14 BSPP	<b>6TRBF6</b>
1"	1" - 11 1/2 NPTF	<b>8TRF8</b>
	1" - 11 BSPP	<b>8TRBF8</b>

## Tema European Female Threaded Plugs



Body Size	Threads	Steel Part #
3/8"	3/8" - 18 NPTF	<b>TR3F3</b>
	3/8" - 19 BSPP	<b>TR3BF3</b>
1/2"	1/2" - 14 NPTF	<b>TR4F4</b>
	1/2" - 14 BSPP	<b>TR4BF4</b>
3/4"	3/4" - 14 NPTF	<b>TR6F6</b>
	3/4" - 14 BSPP	<b>TR6BF6</b>
1"	1" - 11 1/2 NPTF	<b>TR8F8</b>
	1" - 11 BSPP	<b>TR8BF8</b>

## Tema European Coupler Seal Kits



Body Size	Coupler Style	Seal Kit Contents	Nitrile Part #
3/8"	all	two O-rings and one PTFE back-up ring	<b>3TR-SKIT</b>
1/2"	all	two O-rings and one PTFE back-up ring	<b>4TR-SKIT</b>
3/4"	all	two O-rings and one PTFE back-up ring	<b>6TR-SKIT</b>
1"	all	two O-rings and one PTFE back-up ring	<b>8TR-SKIT</b>

## Plug Profiles

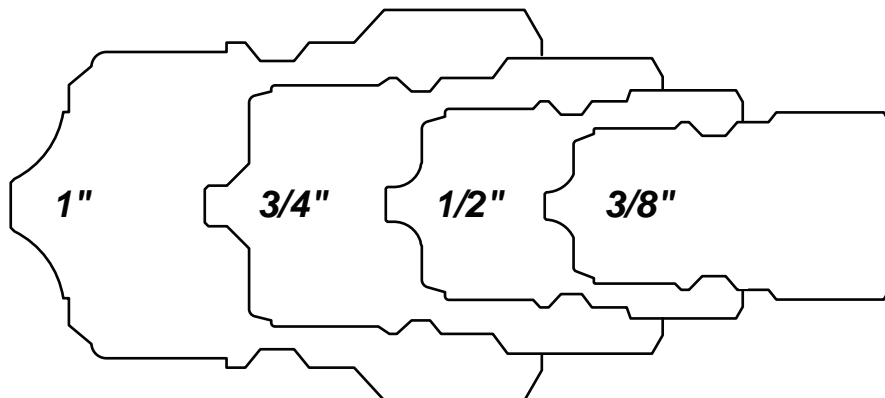

## Industry/Competitor Interchange

TEMA European Interchange  
TEMA 3800, 5000, 7500,  
1000 Series  
CEJN Series 525

Please contact Dixon for dust caps and dust plugs.

## HT-Series Hydraulic Couplings

## Features:

- minimizes fluid loss resulting in a cleaner, safer work environment
- Automatic, push-to-connect couplings provide high flow with low pressure drop assuring maximum hydraulic system performance.
- To reduce the possibility of accidental disconnect, the sleeve lock safety feature requires turning the collar to unlock the coupling.
- Contact Dixon® for additional seal material options.
- Contact Dixon® for pressure ratings and other technical information.
- conforms to ISO16028 interchange standard interchangeable with Eaton/Hansen FF, Parker FEM, Snap-tite 74, Faster FFH/2FFN/2FFI, Stucchi A/FIRG and Holmbury HQ/A/FIMC

## Flushface Female Threaded Couplers

Body Size	Threads	Steel Part #	316 Stainless Steel Part #
1/4"	1/4" - 18 NPTF	<b>2HTF2</b>	---
	1/4" - 19 BSPP	<b>2HTBF2</b>	---
	9/16" - 18 ORB	<b>2HTOF3</b>	---
3/8"	3/8" - 18 NPTF	<b>3HTF3</b>	<b>3HTF3-SS</b>
	3/8" - 19 BSPP	<b>3HTBF3</b>	<b>3HTBF3-SS</b>
	9/16" - 18 ORB	<b>3HTOF3</b>	---
	1/2" - 14 NPTF	<b>3HTF4</b>	<b>3HTF4-SS</b>
	1/2" - 14 BSPP	<b>3HTBF4</b>	<b>3HTBF4-SS</b>
	3/4" - 16 ORB	<b>3HTOF4</b>	---
1/2"	1/2" - 14 NPTF	<b>4HTF4</b>	<b>4HTF4-SS</b>
	1/2" - 14 BSPP	<b>4HTBF4</b>	<b>4HTBF4-SS</b>
	3/4" - 16 ORB	<b>4HTOF4</b>	---
	7/8" - 14 ORB	<b>4HTOF5</b>	---
	3/4" - 14 NPTF	<b>4HTF6</b>	<b>4HTF6-SS</b>
	3/4" - 14 BSPP	<b>4HTBF6</b>	<b>4HTBF6-SS</b>
	1-1/16" - 12 ORB	<b>4HTOF6</b>	---
5/8"	7/8" - 14 ORB	<b>5HTOF5</b>	---
	3/4" - 14 NPTF	<b>5HTF6</b>	<b>5HTF6-SS</b>
	3/4" - 14 BSPP	<b>5HTBF6</b>	<b>5HTBF6-SS</b>
	1-1/16" - 12 ORB	<b>5HTOF6</b>	---
3/4"	7/8" - 14 ORB	<b>6HTOF5</b>	---
	3/4" - 14 NPTF	<b>6HTF6</b>	<b>6HTF6-SS</b>
	3/4" - 14 BSPP	<b>6HTBF6</b>	<b>6HTBF6-SS</b>
	1-1/16" - 12 ORB	<b>6HTOF6</b>	---
	1" - 11 1/2 NPTF	<b>6HTF8</b>	<b>6HTF8-SS</b>
	1" - 11 BSPP	<b>6HTBF8</b>	<b>6HTBF8-SS</b>
	1-5/16" - 12 ORB	<b>6HTOF8</b>	---
1"	1" - 11 1/2 NPTF	<b>8HTF8</b>	<b>8HTF8-SS</b>
	1" - 11 BSPP	<b>8HTBF8</b>	<b>8HTBF8-SS</b>
	1-5/16" - 12 ORB	<b>8HTOF8</b>	---
	1 1/4" - 11 1/2 NPTF	<b>8HTF10</b>	<b>8HTF10-SS</b>
	1 1/4" - 11 BSPP	<b>8HTBF10</b>	<b>8HTBF10-SS</b>
1 1/2"	1 5/8" - 12 ORB	<b>8HTOF10</b>	---
	1 1/2" - 11 1/2 NPTF	<b>12HTF12</b>	---
	1 1/2" - 11 BSPP	<b>12HTBF12</b>	---
2"	1 7/8" - 12 ORB	<b>12HTOF12</b>	---
	2" - 11 1/2 NPTF	<b>16HTF16</b>	---
	2" - 11 BSPP	<b>16HTBF16</b>	---
2"	2 1/2" - 12 ORB	<b>16HTOF16</b>	---



steel



316 stainless

## Flushface Male Threaded Couplers

Body Size	Threads	Steel Part #
3/8"	3/8" - 18 NPTF	<b>3HTM3</b>
	1/2" - 14 NPTF	<b>3HTM4</b>
	9/16" - 18 ORB	<b>3HTOM3</b>
	3/4" - 16 ORB	<b>3HTOM4</b>
1/2"	1/2" - 14 NPTF	<b>4HTM4</b>



4HTM4



3HTOM4



## HT-Series Hydraulic Couplings

Hydraulic Fittings

## Flushface Female Threaded Plugs

Body Size	Threads	Steel Part #	316 Stainless Steel Part #
1/4"	1/4" - 18 NPTF	<b>HT2F2</b>	---
	1/4" - 19 BSPP	<b>HT2BF2</b>	---
	9/16" - 18 ORB	<b>HT2OF3</b>	---
3/8"	3/8" - 18 NPTF	<b>HT3F3</b>	<b>HT3F3-SS</b>
	3/8" - 19 BSPP	<b>HT3BF3</b>	<b>HT3BF3-SS</b>
	9/16" - 18 ORB	<b>HT3OF3</b>	---
	1/2" - 14 NPTF	<b>HT3F4</b>	<b>HT3F4-SS</b>
	1/2" - 14 BSPP	<b>HT3BF4</b>	<b>HT3BF4-SS</b>
	3/4" - 16 ORB	<b>HT3OF4</b>	---
1/2"	1/2" - 14 NPTF	<b>HT4F4</b>	<b>HT4F4-SS</b>
	1/2" - 14 BSPP	<b>HT4BF4</b>	<b>HT4BF4-SS</b>
	3/4" - 16 ORB	<b>HT4OF4</b>	---
	7/8" - 14 ORB	<b>HT4OF5</b>	---
	3/4" - 14 NPTF	<b>HT4F6</b>	<b>HT4F6-SS</b>
	3/4" - 14 BSPP	<b>HT4BF6</b>	<b>HT4BF6-SS</b>
5/8"	1-1/16" - 12 ORB	<b>HT5OF6</b>	---
	7/8" - 14 ORB	<b>HT5OF5</b>	---
	3/4" - 14 NPTF	<b>HT5F6</b>	<b>HT5F6-SS</b>
	3/4" - 14 BSPP	<b>HT5BF6</b>	<b>HT5BF6-SS</b>
3/4"	1-1/16" - 12 ORB	<b>HT6OF6</b>	---
	7/8" - 14 ORB	<b>HT6OF5</b>	---
	3/4" - 14 NPTF	<b>HT6F6</b>	<b>HT6F6-SS</b>
	3/4" - 14 BSPP	<b>HT6BF6</b>	<b>HT6BF6-SS</b>
	1" - 11 1/2 NPTF	<b>HT6F8</b>	<b>HT6F8-SS</b>
	1" - 11 BSPP	<b>HT6BF8</b>	<b>HT6BF8-SS</b>
1"	1-5/16" - 12 ORB	<b>HT8OF8</b>	---
	1" - 11 1/2 NPTF	<b>HT8F8</b>	<b>HT8F8-SS</b>
	1" - 11 BSPP	<b>HT8BF8</b>	<b>HT8BF8-SS</b>
	1-5/16" - 12 ORB	<b>HT8OF8</b>	---
	1 1/4" - 11 1/2 NPTF	<b>HT8F10</b>	<b>HT8F10-SS</b>
1 1/2"	1 1/4" - 11 BSPP	<b>HT8BF10</b>	<b>HT8BF10-SS</b>
	1 1/2" - 11 1/2 NPTF	<b>HT12F12</b>	---
	1 1/2" - 11 BSPP	<b>HT12BF12</b>	---
2"	1 7/8" - 12 ORB	<b>HT12OF12</b>	---
	2" - 11 1/2 NPTF	<b>HT16F16</b>	---
	2" - 11 BSPP	<b>HT16BF16</b>	---
2"	2 1/2" - 12 ORB	<b>HT16OF16</b>	---



steel



316 stainless



## Flushface Male Threaded Plugs



HT4M4



HT3OM4

Body Size	Threads	Steel Part #
3/8"	3/8" - 18 NPTF	<b>HT3M3</b>
	1/2" - 14 NPTF	<b>HT3M4</b>
	9/16" - 18 ORB	<b>HT3OM3</b>
	3/4" - 16 ORB	<b>HT3OM4</b>
1/2"	1/2" - 14 NPTF	<b>HT4M4</b>

HT-Series Hydraulic Couplings

Flushface Male Threaded Bulkhead Couplers

Body Size	Threads	Steel Part #
1/2"	7/8" - 14 JIC BH	<b>4HTJB5</b>
	1" - 14 ORFS BH	<b>4HTRB5</b>
	1-1/16" - 12 JIC BH	<b>4HTJB6</b>



Hydraulic Fittings

Flushface Male Threaded Bulkhead Plugs

Body Size	Threads	Steel Part #
1/2"	7/8" - 14 JIC BH	<b>HT4JB5</b>
	1" - 14 ORFS BH	<b>HT4RB5</b>
	1-1/16" - 12 JIC BH	<b>HT4JB6</b>

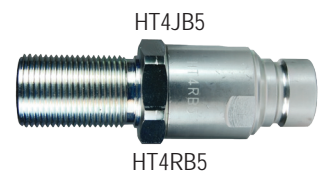

Flushface Coupler Dust Plugs

Body Size	Nitrile Part #
1/4"	<b>2HTDP</b>
3/8"	<b>3HTDP</b>
1/2"	<b>4HTDP</b>
5/8"	<b>5HTDP</b>
3/4"	<b>6HTDP</b>
1"	<b>8HTDP</b>



Flushface Plug Dust Caps

Body Size	Nitrile Part #
1/4"	<b>HT2DC</b>
3/8"	<b>HT3DC</b>
1/2"	<b>HT4DC</b>
5/8"	<b>HT5DC</b>
3/4"	<b>HT6DC</b>
1"	<b>HT8DC</b>



## HT-Series Hydraulic Couplings

Hydraulic Fittings

## Flushface Interchange Coupler Bulkhead Kits

Body Size	Mounting Hole	Description	Steel Part #
1/4"	1.125"	Two 360° retaining rings	<b>2HT-BMK</b>
3/8"	1.250"	Two 360° retaining rings	<b>3HT-BMK</b>
1/2"	1.560"	Two 360° retaining rings	<b>4HT-BMK</b>
5/8"	1.685"	Two 360° retaining rings	<b>5HT-BMK</b>
3/4"	1.870"	Two 360° retaining rings	<b>6HT-BMK</b>
1"	2.310"	Two 360° retaining rings	<b>8HT-BMK</b>

## Flushface Interchange Coupler Seal Kits

Body Size	Coupler Style	Description	Nitrile Part #
1/4"	all	Stem/adaptor/gland O-ring, gland B.U.	<b>2HT-SKIT</b>
3/8"	all	Stem/adaptor/gland O-ring, gland B.U.	<b>3HT-SKIT</b>
1/2"	all	Stem/adaptor/gland O-ring, gland B.U.	<b>4HT-SKIT</b>
5/8"	all	Stem/adaptor/gland O-ring, gland B.U.	<b>5HT-SKIT</b>
3/4"	all	Stem/adaptor/gland O-ring, gland B.U.	<b>6HT-SKIT</b>
1"	all	Stem/adaptor/gland O-ring, gland B.U.	<b>8HT-SKIT</b>

## Flushface Interchange Nipple Seal Kits

Body Size	Nipple Style	Description	Nitrile Part #
1/4"	all	Main valve seal and adapter O-ring	<b>HT2-SKIT-V2</b>
3/8"	all	Main valve seal and adapter O-ring	<b>HT3-SKIT-V2</b>
1/2"	all	Main valve seal and adapter O-ring	<b>HT4-SKIT-V2</b>
5/8"	all	Main valve seal and adapter O-ring	<b>HT5-SKIT-V2</b>
3/4"	all	Main valve seal and adapter O-ring	<b>HT6-SKIT-V2</b>
1"	all	Main valve seal and adapter O-ring	<b>HT8-SKIT-V2</b>

## Profiles

## Industry/Competitor Interchange

Parker FEM-Series, Snap-Tite 74-Series, Hansen FF, Aeroquip/Eaton FD89, Stucchi FIRG/Series 'A', FASTER FFN/FFI/2FFN/2FFI, Safeway FF49-Series

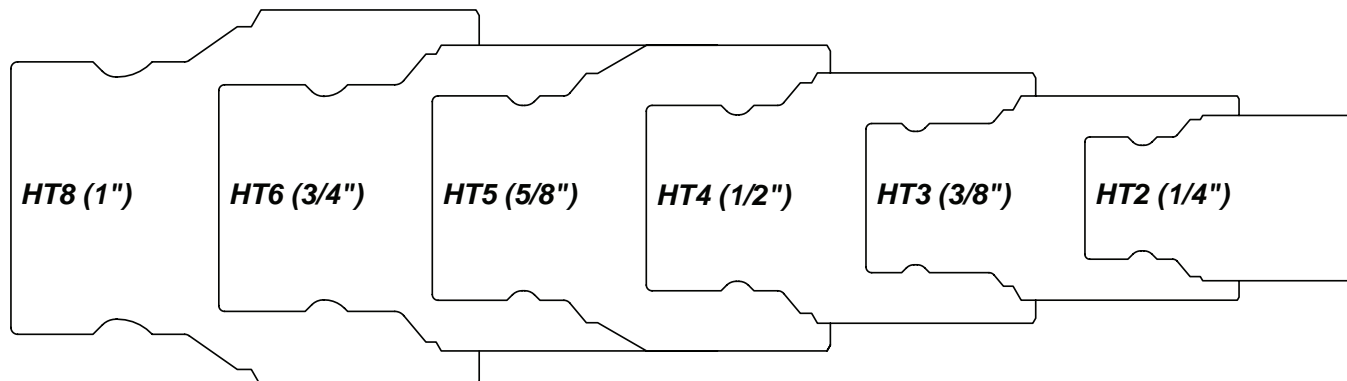

## HTE-Series Hydraulic Couplings

**Features:**

- non-linear connection force at all pressures
- no maximum connection-pressure restrictions, up to **5000 PSI**
- head pressure or valve bleed-by has minimal effect on connection force
- less susceptible to system contamination
- design is scalable performing similarly in all sizes
- smooth connection action
- connectable with trapped pressure on HTE half only
- pressure rating **5000 PSI at 70°F (21°C)**
- conforms to ISO 16028

**Connect Under Pressure Flushface Female Threaded Plug****Feature:**

- for use with HTZ or HT series couplers

Body Size	Threads	Steel Part #
3/8"	1/2"-14 NPTF	<b>HTE3F4</b>
	1/2"-14 BSPP	<b>HTE3BF4</b>
	3/4"-16 ORB	<b>HTE3OF4</b>
1/2"	1/2"-14 NPTF	<b>HTE4F4</b>
	1/2"-14 BSPP	<b>HTE4BF4</b>
	3/4"-16 ORB	<b>HTE4OF4</b>
	7/8"-14 ORB	<b>HTE4OF5</b>
	3/4"-14 NPTF	<b>HTE4F6</b>
	3/4"-14 BSPP	<b>HTE4BF6</b>
	1-1/16"-12 ORB	<b>HTE4OF6</b>
5/8"	7/8"-14 ORB	<b>HTE5OF5</b>
	3/4"-14 NPTF	<b>HTE5F6</b>
	3/4"-14 BSPP	<b>HTE5BF6</b>
	1-1/16"-12 ORB	<b>HTE5OF6</b>
3/4"	3/4"-14 NPTF	<b>HTE6F6</b>
	3/4"-14 BSPP	<b>HTE6BF6</b>
	1-1/16"-12 ORB	<b>HTE6OF6</b>
	1"-11 1/2 NPTF	<b>HTE6F8</b>
	1"-11 BSPP	<b>HTE6BF8</b>
	1-5/16"-12 ORB	<b>HTE6OF8</b>
1"	1"-11 1/2 NPTF	<b>HTE8F8</b>
	1"-11 BSPP	<b>HTE8BF8</b>
	1-5/16"-12 ORB	<b>HTE8OF8</b>
	1 1/4"-11 1/2 NPTF	<b>HTE8F10</b>
	1 1/4"-11 BSPP	<b>HTE8BF10</b>
	1 5/8"-12 ORB	<b>HTE8OF10</b>





## HTZ-Series Hydraulic Couplings

### Flush Face Female Threaded Coupler

Hydraulic Fittings

**NEW**



**Features:**

- for use with HT or HTE series plugs
- connectable with trapped pressure on HTE half only
- connect under pressure up to **1500 PSI at 70°F (21°C)**
- pressure rating **5000 PSI at 70°F (21°C)**

Body Size	Threads	Steel Part #
1/2"	1/2"-14 NPTF	<b>4HTZF4</b>
	3/4"-14 NPTF	<b>4HTZF6</b>
	3/4"-16 ORB	<b>4HTZOF4</b>
	7/8"-14 ORB	<b>4HTZOF5</b>
	1-1/16"-12 ORB	<b>4HTZOF6</b>





## ST-Series Hydraulic Couplings

## Features:

- interchangeable with Snap-Tite 71-Series
- Nitrile (Buna-N) seals standard, providing a temperature range of **-40°F to 250°F (-40°C to 121°C)**
- Contact Dixon® for additional seal material options.
- Contact Dixon® for pressure ratings and other technical information.
- steel coupler sleeves are hardened to resist deformation and maximize service life
- steel nipples are hardened to provide heavy duty performance

## Snap-Tite 71 Female Threaded Couplers

Body Size	Threads	Steel Part #	316 Stainless Steel Part #
¼"	¼" - 18 NPTF	<b>2STF2</b>	<b>2STF2-SS</b>
	¼" - 19 BSPP	<b>2STBF2</b>	<b>2STBF2-SS</b>
⅜"	¼" - 18 NPTF	<b>3STF2</b>	---
	⅜" - 18 NPTF	<b>3STF3</b>	<b>3STF3-SS</b>
	⅜" - 19 BSPP	<b>3STBF3</b>	<b>3STBF3-SS</b>
	½" - 14 NPTF	<b>3STF4</b>	<b>3STF4-SS</b>
	½" - 14 BSPP	<b>3STBF4</b>	<b>3STBF4-SS</b>
½"	½" - 14 NPTF	<b>4STF4</b>	<b>4STF4-SS</b>
	½" - 14 BSPP	<b>4STBF4</b>	<b>4STBF4-SS</b>
	¾" - 16 ORB	<b>4STOF4</b>	---
	¾" - 14 NPTF	<b>6STF6</b>	<b>6STF6-SS</b>
¾"	¾" - 14 BSPP	<b>6STBF6</b>	<b>6STBF6-SS</b>
	1-1/16" - 12 ORB	<b>6STOF6</b>	---
	1" - 11½ NPTF	<b>8STF8</b>	<b>8STF8-SS</b>
1"	1" - 11 BSPP	<b>8STBF8</b>	<b>8STBF8-SS</b>
	1-5/16" - 12 ORB	<b>8STOF8</b>	---
	1¼" - 11½ NPTF	<b>8STF10</b>	<b>8STF10-SS</b>
	1¼" - 11 BSPP	<b>8STBF10</b>	<b>8STBF10-SS</b>
	1⅝" - 12 ORB	<b>8STOF10</b>	---



steel



316 stainless

## Snap-Tite 71 Old Style Female Threaded Couplers

Body Size	Threads	Steel Part #	316 Stainless Steel Part #
1"	1" - 11½ NPTF	<b>8STF8-V2</b>	---
	1" - 11 BSPP	<b>8STBF8-V2</b>	---
	1¼" - 11½ NPTF	<b>8STF10-V2</b>	---
2"	1½" - 11½ NPTF	<b>16STF12</b>	---
	1½" - 11 BSPP	<b>16STBF12</b>	---
	1-7/8" - 12 ORB	<b>16STOF12</b>	---
	2" - 11½ NPTF	<b>16STF16</b>	<b>16STF16-SS</b>
	2" - 11 BSPP	<b>16STBF16</b>	---
	2½" - 12 ORB	<b>16STOF16</b>	---



steel



316 stainless

ST-Series Hydraulic Couplings

Hydraulic Fittings

Snap-Tite 71 Female Threaded Plugs



steel



316 stainless

Body Size	Threads	Steel Part #	316 Stainless Steel Part #
1/4"	1/4" - 18 NPTF	<b>ST2F2</b>	<b>ST2F2-SS</b>
	1/4" - 19 BSPP	<b>ST2BF2</b>	<b>ST2BF2-SS</b>
3/8"	1/4" - 18 NPTF	<b>ST3F2</b>	---
	3/8" - 18 NPTF	<b>ST3F3</b>	<b>ST3F3-SS</b>
	3/8" - 19 BSPP	<b>ST3BF3</b>	<b>ST3BF3-SS</b>
	1/2" - 14 NPTF	<b>ST3F4</b>	<b>ST3F4-SS</b>
1/2"	1/2" - 14 BSPP	<b>ST3BF4</b>	<b>ST3BF4-SS</b>
	3/4" - 16 ORB	---	---
	1/2" - 14 NPTF	<b>ST4F4</b>	<b>ST4F4-SS</b>
	1/2" - 14 BSPP	<b>ST4BF4</b>	<b>ST4BF4-SS</b>
3/4"	3/4" - 14 NPTF	<b>ST6F6</b>	<b>ST6F6-SS</b>
	3/4" - 14 BSPP	<b>ST6BF6</b>	<b>ST6BF6-SS</b>
	1-1/16" - 12 ORB	<b>ST6OF6</b>	---
1"	1" - 11 1/2 NPTF	<b>ST8F8</b>	<b>ST8F8-SS</b>
	1" - 11 BSPP	<b>ST8BF8</b>	<b>ST8BF8-SS</b>
	1-5/16" - 12 ORB	<b>ST8OF8</b>	---
	1 1/4" - 11 1/2 NPTF	<b>ST8F10</b>	<b>ST8F10-SS</b>
	1 1/4" - 11 BSPP	<b>ST8BF10</b>	<b>ST8BF10-SS</b>
	1 5/8" - 12 ORB	<b>ST8OF10</b>	---

Snap-Tite 71 Old Style Female Threaded Plugs



steel



316 stainless

Body Size	Threads	Steel Part #	316 Stainless Steel Part #
1"	1" - 11 1/2 NPTF	<b>ST8F8-V2</b>	---
	1" - 11 BSPP	<b>ST8BF8-V2</b>	---
	1 1/4" - 11 1/2 NPTF	<b>ST8F10-V2</b>	---
2"	1 1/2" - 11 1/2 NPTF	<b>ST16F12</b>	---
	1 1/2" - 11 BSPP	<b>ST16BF12</b>	---
	1-7/8" - 12 ORB	<b>ST16OF12</b>	---
	2" - 11 1/2 NPTF	<b>ST16F16</b>	<b>ST16F16-SS</b>
	2" - 11 BSPP	<b>ST16BF16</b>	---
	2 1/2" - 12 ORB	<b>ST16OF16</b>	---

Plug Profiles

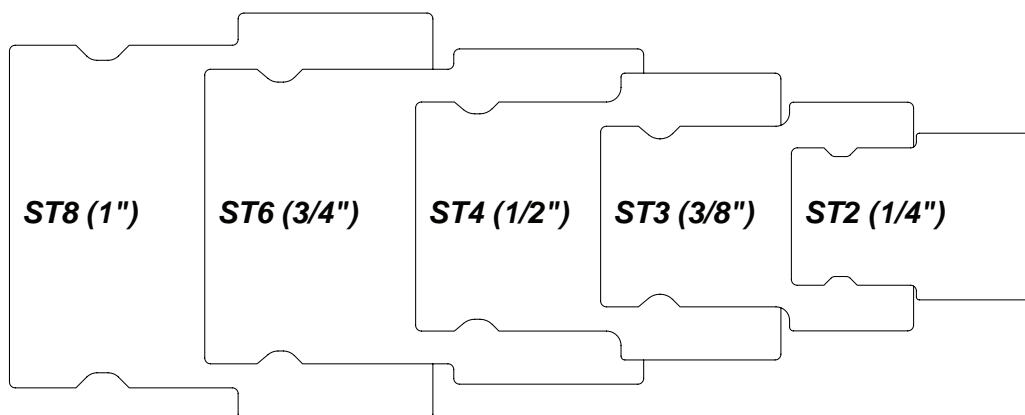

## ST-Series Hydraulic Couplings

## Dust Plugs

Body Size	Aluminum body with steel cable Part #
1/4"	<b>2STDP-A</b>
3/8"	<b>3STDP-A</b>
1/2"	<b>4STDP-A</b>
3/4"	<b>6STDP-A</b>
1"	<b>8STDP-A</b>
1"	<b>8STDP-A-V2</b>
2"	<b>16STDP-A</b>



## Dust Caps

Body Size	Aluminum body with steel cable Part #
1/4"	<b>ST2DC-A</b>
3/8"	<b>ST3DC-A</b>
1/2"	<b>ST4DC-A</b>
3/4"	<b>ST6DC-A</b>
1"	<b>ST8DC-A</b>
1"	<b>ST8DC-A-V2</b>
2"	<b>ST16DC-A</b>



## Snap-Tite 71 Bulkhead Kits

Body Size	Mounting Hole ID	Seal Kit Contents	Steel Part #
1/4"	1.250"	two 360° retaining rings	<b>2ST-BMK</b>
3/8"	1.625"	two 360° retaining rings	<b>3ST-BMK</b>
1/2"	2.000"	two 360° retaining rings	<b>4ST-BMK</b>
3/4"	2.375"	two 360° retaining rings	<b>6ST-BMK</b>

## Snap-Tite 71 Coupler Seal Kits

Body Size	Coupler Style	Seal Kit Contents	Nitrile Part #
1/4"	all	two seals and anti-extrusion rings	<b>2ST-SKIT</b>
3/8"	all	two seals and anti-extrusion rings	<b>3ST-SKIT</b>
1/2"	all	two seals and anti-extrusion rings	<b>4ST-SKIT</b>
3/4"	all	two seals and anti-extrusion rings	<b>6ST-SKIT</b>
1"	all	two seals and anti-extrusion rings	<b>8ST-SKIT</b>
1"	all	three seals and two anti-extrusion rings	<b>8ST-SKIT-V2</b>
2"	all	three seals and two anti-extrusion rings	<b>16ST-SKIT</b>

## Snap-Tite 71 Plug Seal Kits

Body Size	Coupler Style	Seal Kit Contents	Nitrile Part #
1/4"	all	valve O-ring / back-up and adapter O-ring	<b>ST2-SKIT</b>
3/8"	all	valve O-ring / back-up and adapter O-ring	<b>ST3-SKIT</b>
1/2"	all	valve O-ring / back-up and adapter O-ring	<b>ST4-SKIT</b>
3/4"	all	valve O-ring / back-up and adapter O-ring	<b>ST6-SKIT</b>
1"	all	valve O-ring / back-up and adapter O-ring	<b>ST8-SKIT</b>
2"	all	main valve seal	<b>ST16-SKIT</b>

## PD-Series Diagnostic Interchange Couplings

**Features:**

- interchangeable with ISO15171-1, Parker PD-Series, Aeroquip FD90, Tomco Series DK
- steel componentry is plated using ROHS Compliant Trivalent Chrome
- PTFE anti-extrusion ring protects main coupler O-ring from dynamic impulse pressure damage
- nitrile (Buna-N) seal standard, providing a temperature range of **-40°F to 250°F (-40°C to 121°C)**
- pressure rating **6000 PSI at 70°F (21°C)**

**Female NPT Couplers**

Body Size	Threads	Steel Part #
1/8"	1/8" - 27 NPT	<b>1PDF1</b>
	1/4" - 18 NPT	<b>1PDF2</b>

**Male NPT Couplers**

Body Size	Threads	Steel Part #
1/8"	1/4" - 18 NPT	<b>1PDM2</b>

**Female NPT Plugs**

Body Size	Threads	Steel Part #
1/8"	1/8" - 27 NPT	<b>PD1F1</b>
	1/4" - 18 NPT	<b>PD1F2</b>

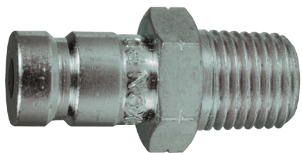
**Male Threaded Plugs**

Body Size	Threads	Steel Part #
1/8"	1/8" - 27 NPT	<b>PD1M1</b>
	1/4" - 18 NPT	<b>PD1M2</b>
	7/16" - 20 ORB	<b>PD1OM2</b>
	9/16" - 18 ORB	<b>PD1OM3</b>

**Dust Caps**

Body Size	Nitrile Part #
1/8"	<b>H1DC</b>

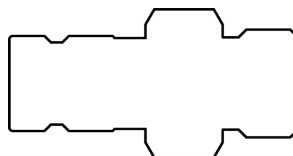
**Plug Profile**

## VEP-Series Hydraulic Couplings

**Features:**

- no-spill, flush face valve minimizes air inclusion during connection and spillage during disconnection
- thread-to-connect design and dual valve system in the plug allow for connecting under pressure
- design eliminates premature wear or brinelling commonly found with locking ball designs when subjected to high impulse pressures
- Zinc nickel plating provides superior corrosion resistance
- interchangeable with Parker FET, Stucchi VEP, DNP PST 4/FSI, Holmbury HFT
- Contact Dixon® for pressure ratings and other technical information.

**Female Threaded Couplers**

Body Size	Threads	Steel Part #
1/4"	1/4" - 18 NPTF	<b>2VEPF2</b>
	1/4" - 19 BSPP	<b>2VEPBF2</b>
	9/16" - 18 ORB	<b>2VEPOF3</b>
3/8"	3/8" - 18 NPTF	<b>3VEPF3</b>
	3/8" - 19 BSPP	<b>3VEPBF3</b>
	3/4" - 16 ORB	<b>3VEPOF4</b>
	1/2" - 14 NPTF	<b>3VEPF4</b>
	1/2" - 14 BSPP	<b>3VEPBF4</b>
1/2"	1/2" - 14 NPTF	<b>4VEPF4</b>
	1/2" - 14 BSPP	<b>4VEPBF4</b>
	3/4" - 16 ORB	<b>4VEPOF4</b>
	7/8" - 14 ORB	<b>4VEPOF5</b>
	3/4" - 14 NPTF	<b>4VEPF6</b>
	3/4" - 14 BSPP	<b>4VEPBF6</b>
	1-1/16" - 12 ORB	<b>4VEPOF6</b>
3/4"	3/4" - 14 NPTF	<b>6VEPF6</b>
	3/4" - 14 BSPP	<b>6VEPBF6</b>
	1-1/16" - 12 ORB	<b>6VEPOF6</b>
1"	1" - 11 1/2 NPTF	<b>8VEPF8</b>
	1" - 11 BSPP	<b>8VEPBF8</b>
	1-5/16" - 12 ORB	<b>8VEPOF8</b>
1 1/4"	1 1/4" - 11 1/2 NPTF	<b>10VEPF10</b>
	1 1/4" - 11 BSPP	<b>10VEPBF10</b>
	1-5/8" - 12 ORB	<b>10VEPOF10</b>
1 1/2"	1 1/2" - 11 1/2 NPTF	<b>12VEPF12</b>
	1 1/2" - 11 BSPP	<b>12VEPBF12</b>
	1-7/8" - 12 ORB	<b>12VEPOF12</b>
2"	2" - 11 1/2 NPTF	<b>16VEPF16</b>
	2" - 11 BSPP	<b>16VEPBF16</b>
	2 1/2" - 12 ORB	<b>16VEPOF16</b>



## VEP-Series Hydraulic Couplings



## Female Threaded Plugs

Body Size	Threads	Steel Part #
1/4"	1/4" - 18 NPTF	<b>VEP2F2</b>
	1/4" - 19 BSPP	<b>VEP2BF2</b>
	9/16" - 18 ORB	<b>VEP2OF2</b>
3/8"	3/8" - 18 NPTF	<b>VEP3F3</b>
	3/8" - 19 BSPP	<b>VEP3BF3</b>
	3/4" - 16 ORB	<b>VEP3OF4</b>
	1/2" - 14 NPTF	<b>VEP3F4</b>
	1/2" - 14 BSPP	<b>VEP3BF4</b>
1/2"	1/2" - 14 NPTF	<b>VEP4F4</b>
	1/2" - 14 BSPP	<b>VEP4BF4</b>
	3/4" - 16 ORB	<b>VEP4OF4</b>
	7/8" - 14 ORB	<b>VEP4OF5</b>
	3/4" - 14 NPTF	<b>VEP4F6</b>
	3/4" - 14 BSPP	<b>VEP4BF6</b>
	1-1/16" - 12 ORB	<b>VEP4OF6</b>
3/4"	3/4" - 14 NPTF	<b>VEP6F6</b>
	3/4" - 14 BSPP	<b>VEP6BF6</b>
	1-1/16" - 12 ORB	<b>VEP6OF6</b>
1"	1" - 11 1/2 NPTF	<b>VEP8F8</b>
	1" - 11 BSPP	<b>VEP8BF8</b>
	1-5/16" - 12 ORB	<b>VEP8OF8</b>
1 1/4"	1 1/4" - 11 1/2 NPTF	<b>VEP10F10</b>
	1 1/4" - 11 BSPP	<b>VEP10BF10</b>
	1-5/8" - 12 ORB	<b>VEP10OF10</b>
1 1/2"	1 1/2" - 11 1/2 NPTF	<b>VEP12F12</b>
	1 1/2" - 11 BSPP	<b>VEP12BF12</b>
	1-7/8" - 12 ORB	<b>VEP12OF12</b>
2"	2" - 11 1/2 NPTF	<b>VEP16F16</b>
	2" - 11 BSPP	<b>VEP16BF16</b>
	2 1/2" - 12 ORB	<b>VEP16OF16</b>

## Dust Plugs



Body Size	Aluminum body with steel cable Part #
1/4"	<b>2VEPDP-A</b>
3/8"	<b>3VEPDP-A</b>
1/2"	<b>4VEPDP-A</b>
3/4"	<b>6VEPDP-A</b>
1"	<b>8VEPDP-A</b>
1 1/4"	<b>10VEPDP-A</b>
1 1/2"	<b>12VEPDP-A</b>
2"	<b>16VEPDP-A</b>

## Dust Caps



Body Size	Aluminum body with steel cable Part #
1/4"	<b>VEP2DC-A</b>
3/8"	<b>VEP3DC-A</b>
1/2"	<b>VEP4DC-A</b>
3/4"	<b>VEP6DC-A</b>
1"	<b>VEP8DC-A</b>
1 1/4"	<b>VEP10DC-A</b>
1 1/2"	<b>VEP12DC-A</b>
2"	<b>VEP16DC-A</b>

VEP-Series Hydraulic Couplings

Code 62 Flange Head Coupler

Body Size	Port Size	Steel Part #
3/4"	3/4"	<b>6VEPFH6</b>
1"	1"	<b>8VEPFH8</b>
1 1/4"	1 1/4"	<b>10VEPFH10</b>
1 1/2"	1 1/2"	<b>12VEPFH12</b>
2"	2"	<b>16VEPFH16</b>



flange head coupler

Hydraulic Fittings

Code 62 Flange Head Plug

Body Size	Port Size	Steel Part #
3/4"	3/4"	<b>VEP6FH6</b>
1"	1"	<b>VEP8FH8</b>
1 1/4"	1 1/4"	<b>VEP10FH10</b>
1 1/2"	1 1/2"	<b>VEP12FH12</b>
2"	2"	<b>VEP16FH16</b>



flange head plug

Code 62 Flange Pad Coupler

Body Size	Port Size	Steel Part #
3/4"	3/4"	<b>6VEFPF6</b>
1"	1"	<b>8VEFPF8</b>
1 1/4"	1 1/4"	<b>10VEFPF10</b>
1 1/2"	1 1/2"	<b>12VEFPF12</b>
2"	2"	<b>16VEFPF16</b>



flange pad coupler

Code 62 Flange Pad Plug

Body Size	Port Size	Steel Part #
3/4"	3/4"	<b>VEP6FP6</b>
1"	1"	<b>VEP8FP8</b>
1 1/4"	1 1/4"	<b>VEP10FP10</b>
1 1/2"	1 1/2"	<b>VEP12FP12</b>
2"	2"	<b>VEP16FP16</b>



flange pad plug

## VEP-BOP Series Hydraulic Couplings

**Features:**

- red powder coated components and external O-rings for easy BOP service identification
- steel components are plated using ROHS compliant zinc nickel
- blow-out preventer (BOP) coupling critical seals are severe service FKM
- interchangeable with VEP/VEP-HD Series, DNP FSI-BOP Series
- pressure rating **5000 PSI at 70°F (21°C)**
- BOP couplings have been fire tested and Lloyd's certified to **1300°F (700°C)** in accordance with API 16D. Certificate available upon request.

**Female Threaded Couplers**

Body Size	Threads	Steel Part #
3/8"	3/8" - 18 NPTF	<b>3VEPF3-BOP</b>
1/2"	1/2" - 14 NPTF	<b>4VEPF4-BOP</b>
3/4"	3/4" - 14 NPTF	<b>6VEPF6-BOP</b>
1"	1" - 11½ NPTF	<b>8VEPF8-BOP</b>
1¼"	1¼" - 11½ NPTF	<b>10VEPF10-BOP</b>
1½"	1½" - 11½ NPTF	<b>12VEPF12-BOP</b>

**Female Threaded Plugs**

Body Size	Threads	Steel Part #
3/8"	3/8" - 18 NPTF	<b>VEP3F3-BOP</b>
1/2"	1/2" - 14 NPTF	<b>VEP4F4-BOP</b>
3/4"	3/4" - 14 NPTF	<b>VEP6F6-BOP</b>
1"	1" - 11½ NPTF	<b>VEP8F8-BOP</b>
1¼"	1¼" - 11½ NPTF	<b>VEP10F10-BOP</b>
1½"	1½" - 11½ NPTF	<b>VEP12F12-BOP</b>



## W-Series Hydraulic Couplings

**Applications:**

- Designed for applications requiring a coupling that can be connected under residual pressure with minimum spillage and air inclusion. Widely used on dump trailer wet-line hydraulic systems and oil field equipment. Not recommended for continuous hydraulic impulse applications.

**Features:**

- interchangeable with Aeroquip 5100 series, Parker 6100 series and Snap-Tite 78 series
- nitrile (Buna-N) seals are standard, providing a temperature range of **-40°F to 250°F** (**-40°C to 121°C**)
- Contact Dixon® for pressure ratings and other technical information.

**Female Threaded Couplers**

Body Size	Threads	Previous Part #	Brass Part #	Steel Part #
1/4"	1/8" - 27 NPTF	---	<b>2WF1-B</b>	---
3/8"	1/4" - 18 NPTF	---	<b>3WF2-B</b>	---
	3/8" - 18 NPTF	---	<b>3WF3-B</b>	---
3/4"	1/2" - 14 NPTF	---	<b>6WF4-B</b>	---
	1/2" - 14 BSPP	---	<b>6WBF4-B</b>	---
	3/4" - 14 NPTF	78-600	<b>6WF6-B</b>	---
	3/4" - 14 BSPP	---	<b>6WBF6-B</b>	---
1"	1" - 11 1/2 NPTF	78-800	<b>8WF8-B</b>	<b>8WF8</b>
	1" - 11 BSPP	---	<b>8WBF8-B</b>	---
1 1/4"	1 1/4" - 11 1/2 NPTF	78-1000	<b>10WF10-B</b>	---
	1 1/4" - 11 BSPP	---	<b>10WBF10-B</b>	---
1 1/2"	1 1/2" - 11 1/2 NPTF	78-1200	<b>12WF12-B</b>	---
	1 1/2" - 11 BSPP	---	<b>12WBF12-B</b>	---



brass

steel

**Hex-Nut Female Threaded Couplers**

Body Size	Threads	Brass Part #	Steel Part #
1/4"	1/8" - 27 NPTF	<b>2WF1-B-HN</b>	---
3/8"	1/4" - 18 NPTF	<b>3WF2-B-HN</b>	---
	3/8" - 18 NPTF	<b>3WF3-B-HN</b>	---
3/4"	1/2" - 14 NPTF	<b>6WF4-B-HN</b>	---
	1/2" - 14 BSPP	<b>6WBF4-B-HN</b>	---
	3/4" - 14 NPTF	<b>6WF6-B-HN</b>	---
	3/4" - 14 BSPP	<b>6WBF6-B-HN</b>	---
1"	1" - 11 1/2 NPTF	<b>8WF8-B-HN</b>	<b>8WF8-HN</b>
	1" - 11 BSPP	<b>8WBF8-B-HN</b>	---
1 1/4"	1 1/4" - 11 1/2 NPTF	<b>10WF10-B-HN</b>	---
	1 1/4" - 11 BSPP	<b>10WBF10-B-HN</b>	---
1 1/2"	1 1/2" - 11 1/2 NPTF	<b>12WF12-B-HN</b>	---
	1 1/2" - 11 BSPP	<b>12WBF12-B-HN</b>	---



brass

steel

## W-Series Hydraulic Couplings

## Hydraulic Fittings



brass

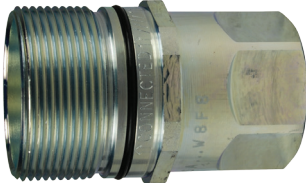

steel

## Female Threaded Plugs

Body Size	Threads	Previous Part #	Brass Part #	Steel Part #
1/4"	1/8" - 27 NPTF	---	<b>W2F1-B</b>	---
3/8"	1/4" - 18 NPTF	---	<b>W3F2-B</b>	---
	3/8" - 18 NPTF	---	<b>W3F3-B</b>	---
3/4"	1/2" - 14 NPTF	---	<b>W6F4-B</b>	---
	1/2" - 14 BSPP	---	<b>W6BF4-B</b>	---
	3/4" - 14 NPTF	79-600	<b>W6F6-B</b>	---
	3/4" - 14 BSPP	---	<b>W6BF6-B</b>	---
1"	1" - 11 1/2 NPTF	79-800	<b>W8F8-B</b>	<b>W8F8</b>
	1" - 11 BSPP	---	<b>W8BF8-B</b>	---
1 1/4"	1 1/4" - 11 1/2 NPTF	79-1000	<b>W10F10-B</b>	---
	1 1/4" - 11 BSPP	---	<b>W10BF10-B</b>	---
1 1/2"	1 1/2" - 11 1/2 NPTF	79-1200	<b>W12F12-B</b>	---
	1 1/2" - 11 BSPP	---	<b>W12BF12-B</b>	---

## Flanges



Body Size	Bolt Hole Size	Previous Part #	Steel Part #
3/4"	0.201"	77-600	<b>W6-BMF</b>
1"	0.201"	77-800	<b>W8-BMF</b>
1 1/4"	0.201"	77-1000	<b>W10-BMF</b>
1 1/2"	0.201"	77-1200	<b>W12-BMF</b>

## Dust Plugs



Body Size	Previous Part #	Steel body with steel cable Part #
1/4"	---	<b>2WDP</b>
3/8"	---	<b>3WDP</b>
3/4"	78-006	<b>6WDP</b>
1"	78-008	<b>8WDP</b>
1 1/4"	78-010	<b>10WDP</b>
1 1/2"	78-012	<b>12WDP</b>

## Dust Caps



Body Size	Previous Part #	Steel body with steel cable Part #
1/4"	---	<b>W2DC</b>
3/8"	---	<b>W3DC</b>
3/4"	79-006	<b>W6DC</b>
1"	79-008	<b>W8DC</b>
1 1/4"	79-010	<b>W10DC</b>
1 1/2"	79-012	<b>W12DC</b>

W-Series Hydraulic Couplings

Coupler Repair Kits

Body Size	Coupler Style	Seal Kit Contents	Nitrile Part #
3/4"	all	bonded valve, O-rings, and PTFE backup	<b>6W-RKIT-V2</b>
1"	all	bonded valve, O-rings, and PTFE backup	<b>8W-RKIT-V2</b>
1 1/4"	all	bonded valve, O-rings, and PTFE backup	<b>10W-RKIT-V2</b>
1 1/2"	all	bonded valve, O-rings, and PTFE backup	<b>12W-RKIT-V2</b>



Hydraulic Fittings

Plug Repair Kits

Body Size	Coupler Style	Seal Kit Contents	Nitrile Part #
3/4"	all	valve assembly and O-ring	<b>W6-RKIT-V2</b>
1"	all	valve assembly and O-ring	<b>W8-RKIT-V2</b>
1 1/4"	all	valve assembly and O-ring	<b>W10-RKIT-V2</b>
1 1/2"	all	valve assembly and O-ring	<b>W12-RKIT-V2</b>



Profiles

Industry/Competitor Interchange

Aeroquip 5100  
Parker 6100

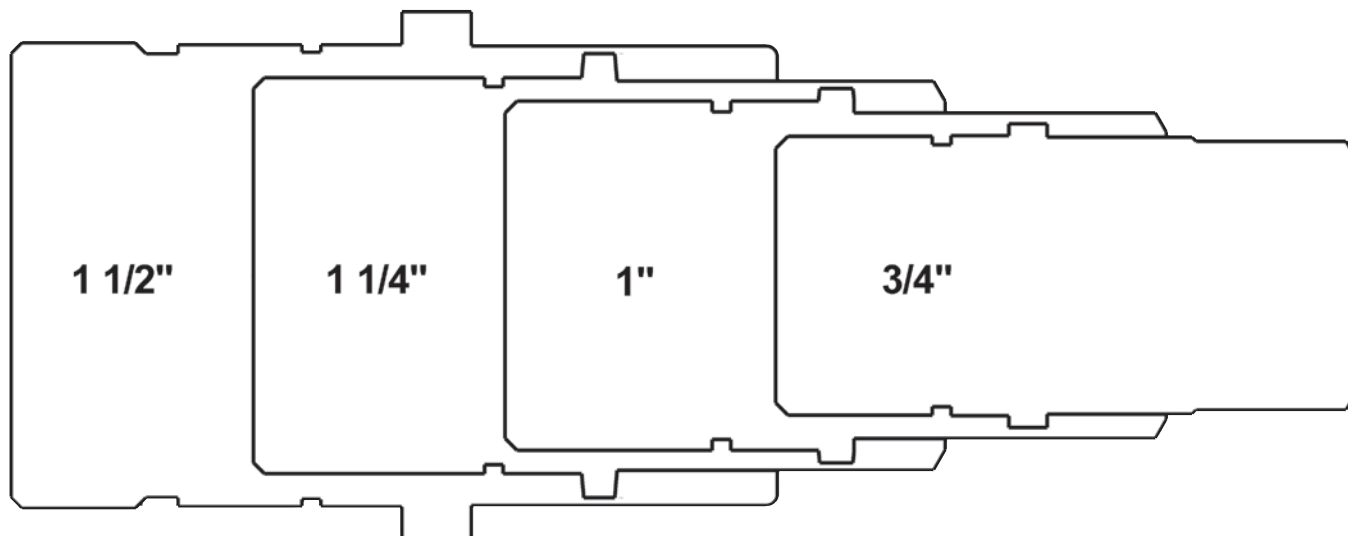

## WS-Series Hydraulic Couplings

**Application:**

- used extensively in oil field and off shore oil rig applications

**Features:**

- interchanges with Snap-Tite 75 series
- Nitrile (Buna-N) seals standard, providing a temperature range of **-40°F to 250°F (-40°C to 121°C)**
- Contact Dixon® for pressure ratings and other technical information.

**High Pressure Wingstyle Female Threaded Couplers**

steel



316 stainless

Body Size	Threads	Steel Part #	316 Stainless Steel Part #
¾"	½" - 14 NPTF	<b>6WSF4</b>	---
	¾" - 14 NPTF	<b>6WSF6</b>	<b>6WSF6-SS</b>
	¾" - 14 BSPP	<b>6WSBF6</b>	<b>6WSBF6-SS</b>
	1-1/16" - 12 ORB	<b>6WSOF6</b>	---
1"	1" - 11½ NPTF	<b>8WSF8</b>	<b>8WSF8-SS</b>
	1" - 11 BSPP	<b>8WSBF8</b>	<b>8WSBF8-SS</b>
	1-5/16" - 12 ORB	<b>8WSOF8</b>	---
1¼"	1¼" - 11½ NPTF	<b>10WSF10</b>	<b>10WSF10-SS</b>
	1¼" - 11 BSPP	<b>10WSBF10</b>	<b>10WSBF10-SS</b>
	1⅝" - 12 ORB	<b>10WSOF10</b>	---
1½"	1½" - 11½ NPTF	<b>12WSF12</b>	<b>12WSF12-SS</b>
	1½" - 11 BSPP	<b>12WSBF12</b>	<b>12WSBF12-SS</b>
	1⅞" - 12 ORB	<b>12WSOF12</b>	---
2"	2" - 11½ NPTF	<b>16WSF16</b>	<b>16WSF16-SS</b>
	2" - 11 BSPP	<b>16WSBF16</b>	<b>16WSBF16-SS</b>
	2½" - 12 ORB	<b>16WSOF16</b>	---

**High Pressure Wingstyle Female Threaded Plugs**

steel



316 stainless

Body Size	Threads	Steel Part #	316 Stainless Steel Part #
¾"	½" - 14 NPTF	<b>WS6F4</b>	---
	¾" - 14 NPTF	<b>WS6F6</b>	<b>WS6F6-SS</b>
	¾" - 14 BSPP	<b>WS6BF6</b>	<b>WS6BF6-SS</b>
	1-1/16" - 12 ORB	<b>WS6OF6</b>	---
1"	1" - 11½ NPTF	<b>WS8F8</b>	<b>WS8F8-SS</b>
	1" - 11 BSPP	<b>WS8BF8</b>	<b>WS8BF8-SS</b>
	1-5/16" - 12 ORB	<b>WS8OF8</b>	---
1¼"	1¼" - 11½ NPTF	<b>WS10F10</b>	<b>WS10F10-SS</b>
	1¼" - 11 BSPP	<b>WS10BF10</b>	<b>WS10BF10-SS</b>
	1⅝" - 12 ORB	<b>WS10OF10</b>	---
1½"	1½" - 11½ NPTF	<b>WS12F12</b>	<b>WS12F12-SS</b>
	1½" - 11 BSPP	<b>WS12BF12</b>	<b>WS12BF12-SS</b>
	1⅞" - 12 ORB	<b>WS12OF12</b>	---
2"	2" - 11½ NPTF	<b>WS16F16</b>	<b>WS16F16-SS</b>
	2" - 11 BSPP	<b>WS16BF16</b>	<b>WS16BF16-SS</b>
	2½" - 12 ORB	<b>WS16OF16</b>	---

WS-Series Hydraulic Couplings

High Pressure Wingstyle Code 62 Flange Head Coupler

Body Size	Port Size	Steel Part #
3/4"	3/4"	<b>6WSFH6</b>
1"	1"	<b>8WSFH8</b>
1 1/4"	1 1/4"	<b>10WSFH10</b>
1 1/2"	1 1/2"	<b>12WSFH12</b>
2"	2"	<b>16WSFH16</b>

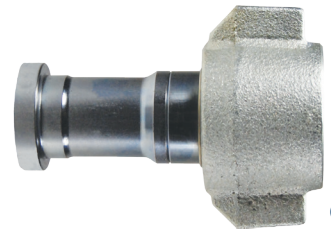

Hydraulic Fittings

High Pressure Wingstyle Code 62 Flange Head Plug

Body Size	Port Size	Steel Part #
3/4"	3/4"	<b>WS6FH6</b>
1"	1"	<b>WS8FH8</b>
1 1/4"	1 1/4"	<b>WS10FH10</b>
1 1/2"	1 1/2"	<b>WS12FH12</b>
2"	2"	<b>WS16FH16</b>



High Pressure Wingstyle Code 62 Flange Pad Coupler

Body Size	Port Size	Steel Part #
3/4"	3/4"	<b>6WSFP6</b>
1"	1"	<b>8WSFP8</b>
1 1/4"	1 1/4"	<b>10WSFP10</b>
1 1/2"	1 1/2"	<b>12WSFP12</b>
2"	2"	<b>16WSFP16</b>

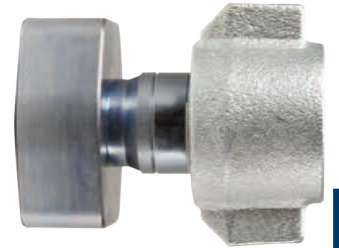

High Pressure Wingstyle Code 62 Flange Pad Plug

Body Size	Port Size	Steel Part #
3/4"	3/4"	<b>WS6FP6</b>
1"	1"	<b>WS8FP8</b>
1 1/4"	1 1/4"	<b>WS10FP10</b>
1 1/2"	1 1/2"	<b>WS12FP12</b>
2"	2"	<b>WS16FP16</b>

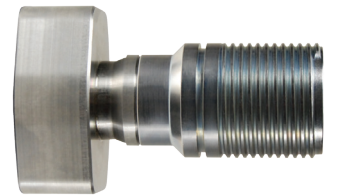

## WS-Series Hydraulic Couplings

Hydraulic Fittings



## High Pressure Wingstyle Rigid Dust Plugs

Body Size	Aluminum body with steel cable Part #
3/4"	<b>6WSDP-A</b>
1"	<b>8WSDP-A</b>
1 1/4"	<b>10WSDP-A</b>
1 1/2"	<b>12WSDP-A</b>
2"	<b>16WSDP-A</b>

## High Pressure Wingstyle Rigid Dust Caps



Body Size	Aluminum body with steel cable Part #
3/4"	<b>WS6DC-A</b>
1"	<b>WS8DC-A</b>
1 1/4"	<b>WS10DC-A</b>
1 1/2"	<b>WS12DC-A</b>
2"	<b>WS16DC-A</b>

## High Pressure Wingstyle Coupler Seal Kits



Body Size	Coupler Style	Seal Kit Contents	Nitrile Part #
3/4"	all	body / valve seals and retaining rings	<b>6WS-SKIT</b>
1"	all	body / valve seals and retaining rings	<b>8WS-SKIT</b>
1 1/4"	all	body / valve seals and retaining rings	<b>10WS-SKIT</b>
1 1/2"	all	body / valve seals and retaining rings	<b>12WS-SKIT</b>
2"	all	body / valve seals and retaining rings	<b>16WS-SKIT</b>

## High Pressure Wingstyle Coupler Repair Kits



Body Size	Coupler Style	Repair Kit Contents	Nitrile Part #
3/4"	all	valve assembly, O-ring, and PTFE B.U.	<b>6WS-RKIT</b>
1"	all	valve assembly, O-ring, and PTFE B.U.	<b>8WS-RKIT</b>
1 1/4"	all	valve assembly, O-ring, and PTFE B.U.	<b>10WS-RKIT</b>
1 1/2"	all	valve assembly, O-ring, and PTFE B.U.	<b>12WS-RKIT</b>
2"	all	valve assembly, O-ring, and PTFE B.U.	<b>16WS-RKIT</b>

## WS-BOP Series Hydraulic Couplings

**Applications:**

- designed for use in oil rig BOP systems where couplings are required to operate under fire conditions in an emergency

**Features:**

- fire tested and Lloyd's certified to **1300°F (700°C)** in accordance with API 16D (Certificate #NAO 0601041/1)
- Contact Dixon® for pressure ratings and other technical information.
- Sleeve is cast using a process that provides better surface finishes, tighter tolerance control, and excellent repeatability.
- Blowout Preventer Couplings are individually marked with the BOP series designation.

**High Pressure Wingstyle Female Threaded Couplers**

Body Size	Threads	Steel Part #	316 Stainless Steel Part #
¾"	½" - 14 NPTF	<b>6WSF4-BOP</b>	---
	¾" - 14 NPTF	<b>6WSF6-BOP</b>	<b>6WSF6-SS-BOP</b>
1"	1" - 11½ NPTF	<b>8WSF8-BOP</b>	<b>8WSF8-SS-BOP</b>
1¼"	1¼" - 11½ NPTF	<b>10WSF10-BOP</b>	<b>10WSF10-SS-BOP</b>
1½"	1½" - 11½ NPTF	<b>12WSF12-BOP</b>	<b>12WSF12-SS-BOP</b>
2"	2" - 11½ NPTF	<b>16WSF16-BOP</b>	<b>16WSF16-SS-BOP</b>

**High Pressure Wingstyle Female Threaded Plugs**

Body Size	Threads	Steel Part #	316 Stainless Steel Part #
¾"	½" - 14 NPTF	<b>WS6F4-BOP</b>	---
	¾" - 14 NPTF	<b>WS6F6-BOP</b>	<b>WS6F6-SS-BOP</b>
1"	1" - 11½ NPTF	<b>WS8F8-BOP</b>	<b>WS8F8-SS-BOP</b>
1¼"	1¼" - 11½ NPTF	<b>WS10F10-BOP</b>	<b>WS10F10-SS-BOP</b>
1½"	1½" - 11½ NPTF	<b>WS12F12-BOP</b>	<b>WS12F12-SS-BOP</b>
2"	2" - 11½ NPTF	<b>WS16F16-BOP</b>	<b>WS16F16-SS-BOP</b>

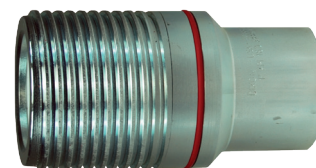
**High Pressure Wingstyle Seal Kits**

Body Size	Coupler Style	Repair Kit Contents	FR FKM Part #
¾"	all	body / valve seals and retaining rings	<b>6BOP-SKIT</b>
1"	all	body / valve seals and retaining rings	<b>8BOP-SKIT</b>
1¼"	all	body / valve seals and retaining rings	<b>10BOP-SKIT</b>
1½"	all	body / valve seals and retaining rings	<b>12BOP-SKIT</b>
2"	all	body / valve seals and retaining rings	<b>16BOP-SKIT</b>



## T-Series Hydraulic Couplings

**Applications:**

- Designed for high pressure applications including hydraulic rams and pumps where low flow and pressures up to 10,000 PSI are encountered.

**Features:**

- interchangeable with Parker 3000 and Enerpac C 604
- nitrile O-ring with TPC-ET back up ring standard providing a temperature range of **-40°F to 250°F (-40°C to 121°C)**
- both poppet valve and ball valve styles available

**Female NPTF Ball Coupler**

Body Size	Threads	Previous Part #	Steel	
			Part #	Part #
3/8"	3/8" - 18 NPTF	30-300F		<b>3TF3</b>

**Male NPTF Ball Couplers**

Body Size	Threads	Previous Part #	Steel Part #	Threads	316 Stainless Steel Part #
1/4"	1/4" - 18 NPTF	30-200	<b>2TM2</b>	---	---
3/8"	3/8" - 18 NPTF	30-300	<b>3TM3</b>	3/8" - 18 NPT	<b>3TM3-SS</b>

**Male NPTF Poppet Couplers**

Body Size	Threads	Steel Part #	316 Stainless Steel Part #
3/8"	3/8" - 18 NPT	<b>3TM3-PV</b>	<b>3TM3-SS-PV</b>

**Female NPTF Ball Plugs**

Body Size	Threads	Previous Part #	Steel Part #	Threads	316 Stainless Steel Part #
1/4"	1/4" - 18 NPTF	31-200	<b>T2F2</b>	---	---
3/8"	3/8" - 18 NPTF	31-300	<b>T3F3</b>	3/8" - 18 NPT	<b>T3F3-SS</b>

**Female NPTF Poppet Plugs**

Body Size	Threads	Steel Part #	316 Stainless Steel Part #
3/8"	3/8" - 18 NPT	<b>T3F3-PV</b>	<b>T3F3-SS-PV</b>



T-Series Hydraulic Couplings

Dust Plugs

Body Size	Previous Part #	Steel body with rubber lanyard Part #
1/4"	30-200DP	<b>2TDP</b>
3/8"	30-300DP	<b>3TDP</b>



Dust Caps

Body Size	Previous Part #	Steel body with steel cable Part #
1/4"	31-200DC	<b>T2DC</b>
3/8"	31-300DC	<b>T3DC</b>



Ball Coupler Seal Kits

Body Size	Coupler Style	Seal Kit Contents	Urethane Part #
1/4"	ball valve	body seal	<b>2T-SKIT</b>
3/8"	ball valve	body seal	<b>3T-SKIT</b>



Plug Profiles

Industry/Competitor Interchange

Parker 3000  
Enerpac C604

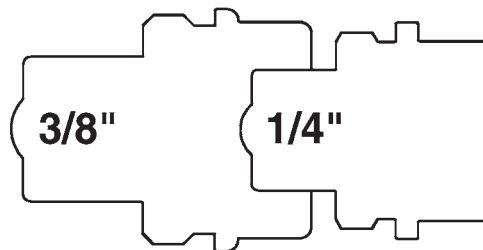

## CVV-Series Hydraulic Couplings

## Features:

- nitrile (Buna-N) seal standard, providing a temperature range of **-40°F to 250°F (-40°C to 121°C)**
- Contact Dixon® for pressure ratings and other technical information.
- interchangeable with European Screw-Together, Inteva STG-Series, Faster CVV-Series, DNP PVV3, Voswinkel Type-HS

## European Female Threaded Couplers

Body Size	Threads	Steel Part #
¼"	¼" - 18 NPTF	<b>2CVVF2</b>
	¼" - 19 BSPP	<b>2CVVBF2</b>
	M14X1.5	<b>2CVVFM1415</b>
⅜"	⅜" - 18 NPTF	<b>3CVVF3</b>
	⅜" - 19 BSPP	<b>3CVVBF3</b>
	M16X1.5	<b>3CVVFM1615</b>
½"	½" - 14 NPTF	<b>4CVVF4</b>
	¾" - 16 ORB	<b>4CVVOF4</b>
	½" - 14 BSPP	<b>4CVVBF4</b>
	M18X1.5	<b>4CVVFM1815</b>
	⅞" - 14 ORB	<b>4CVVOF5</b>
¾"	M22X1.5	<b>4CVVFM2215</b>
	¾" - 14 NPTF	<b>6CVVF6</b>
	¾" - 14 BSPP	<b>6CVVBF6</b>
1"	M22X1.5	<b>6CVVFM2215</b>
	1" - 11½ NPTF	<b>8CVVF8</b>
	1" - 11 BSPP	<b>8CVVBF8</b>
1¼"	1¼" - 11½ NPTF	<b>10CVVF10</b>
	1¼" - 11 BSPP	<b>10CVVBF10</b>



## European Female Threaded Plugs

Body Size	Threads	Steel Part #
¼"	¼" - 18 NPTF	<b>CVV2F2</b>
	¼" - 19 BSPP	<b>CVV2BF2</b>
	M14X1.5	<b>CVV2FM1415</b>
⅜"	⅜" - 18 NPTF	<b>CVV3F3</b>
	⅜" - 19 BSPP	<b>CVV3BF3</b>
	M16X1.5	<b>CVV3FM1615</b>
½"	½" - 14 NPTF	<b>CVV4F4</b>
	¾" - 16 ORB	<b>CVV4OF4</b>
	½" - 14 BSPP	<b>CVV4BF4</b>
	M18X1.5	<b>CVV4FM1815</b>
	⅞" - 14 ORB	<b>CVV4OF5</b>
¾"	M22X1.5	<b>CVV4FM2215</b>
	¾" - 14 NPTF	<b>CVV6F6</b>
	¾" - 14 BSPP	<b>CVV6BF6</b>
1"	M22X1.5	<b>CVV6FM2215</b>
	1" - 11½ NPTF	<b>CVV8F8</b>
	1" - 11 BSPP	<b>CVV8BF8</b>
1¼"	1¼" - 11½ NPTF	<b>CVV10F10</b>
	1¼" - 11 BSPP	<b>CVV10BF10</b>



## CVV-Series Hydraulic Couplings

## European Dust Plugs

Body Size	<i>Plastic</i> Part #
1/4"	<b>2CVVDP</b>
3/8"	<b>3CVVDP</b>
1/2"	<b>4CVVDP</b>
3/4"	<b>6CVVDP</b>
1"	<b>8CVVDP</b>
1 1/4"	<b>10CVVDP</b>



Hydraulic Fittings

## European Dust Caps

Body Size	<i>Plastic</i> Part #
1/4"	<b>CVV2DC</b>
3/8"	<b>CVV3DC</b>
1/2"	<b>CVV4DC</b>
3/4"	<b>CVV6DC</b>
1"	<b>CVV8DC</b>
1 1/4"	<b>CVV10DC</b>



## E-Series Hydraulic Couplings

## Features:

- couplers have no internal valves which provide maximum flow with minimum pressure drop
- nitrile (Buna-N) seals are standard, providing a temperature range of **-40°F to 250°F** (-40°C to 121°C)
- Contact Dixon® for additional seal material options.
- Contact Dixon® for pressure ratings and other technical information.
- interchanges with Parker ST, Hannifin SST/BST, Foster FST, Hansen ST, and Tomco ST couplings
- *Do not disconnect with pressure in line.* 

## Straight Through Female Threaded Couplers



brass

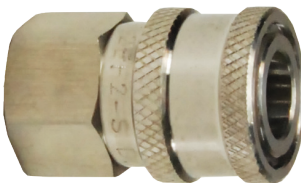

303 stainless

Body Size	Threads	Brass		303 Stainless Steel	
		Previous Part #	Part #	Previous Part #	Part #
1/8"	1/8" - 27 NPTF	---	<b>1EF1-B</b>	---	<b>1EF1-S</b>
1/4"	1/4" - 18 NPTF	STFC2	<b>2EF2-B</b>	STFC2SS	<b>2EF2-S</b>
	1/4" - 19 BSPP	---	<b>2EBF2-B</b>	---	---
3/8"	3/8" - 18 NPTF	STFC3	<b>3EF3-B</b>	STFC3SS	<b>3EF3-S</b>
	3/8" - 19 BSPP	---	<b>3EBF3-B</b>	---	---
1/2"	1/2" - 14 NPTF	STFC4	<b>4EF4-B</b>	STFC4SS	<b>4EF4-S</b>
	1/2" - 14 BSPP	---	<b>4EBF4-B</b>	---	---
3/4"	3/4" - 14 NPTF	STFC6	<b>6EF6-B</b>	STFC6SS	<b>6EF6-S</b>
	3/4" - 14 BSPP	---	<b>6EBF6-B</b>	---	---
1"	1" - 11½ NPTF	STFC8	<b>8EF8-B</b>	STFC8SS	<b>8EF8-S</b>
	1" - 11 BSPP	---	<b>8EBF8-B</b>	---	---
1¼"	1¼" - 11½ NPTF	STFC10	<b>10EF10-B</b>	---	<b>10EF10-S</b>
1½"	1½" - 11½ NPTF	STFC12	<b>12EF12-B</b>	---	<b>12EF12-S</b>
2"	2" - 11½ NPTF	STFC16	<b>16EF16-B</b>	---	<b>16EF16-S</b>

## Straight Through Male Threaded Couplers



brass

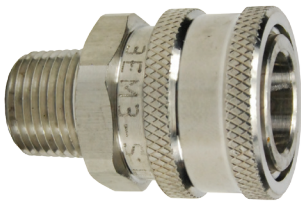

303 stainless

Body Size	Threads	Brass		303 Stainless Steel	
		Previous Part #	Part #	Previous Part #	Part #
1/8"	1/8" - 27 NPTF	---	<b>1EM1-B</b>	---	<b>1EM1-S</b>
1/4"	1/4" - 18 NPTF	STMC2	<b>2EM2-B</b>	STMC2SS	<b>2EM2-S</b>
3/8"	3/8" - 18 NPTF	STMC3	<b>3EM3-B</b>	STMC3SS	<b>3EM3-S</b>
1/2"	1/2" - 14 NPTF	STMC4	<b>4EM4-B</b>	STMC4SS	<b>4EM4-S</b>
3/4"	3/4" - 14 NPTF	STMC6	<b>6EM6-B</b>	STMC6SS	<b>6EM6-S</b>
1"	1" - 11½ NPTF	STMC8	<b>8EM8-B</b>	STMC8SS	<b>8EM8-S</b>
1¼"	1¼" - 11½ NPTF	STMC10	<b>10EM10-B</b>	---	---
1½"	1½" - 11½ NPTF	STMC12	<b>12EM12-B</b>	---	---
2"	2" - 11½ NPTF	STMC16	<b>16EM16-B</b>	---	---

## Straight Through Hose Barb Couplers



Body Size	Hose ID	Brass Part #
1/4"	1/4"	<b>2ES2-B</b>
3/8"	3/8"	<b>3ES3-B</b>
1/2"	1/2"	<b>4ES4-B</b>
3/4"	3/4"	<b>6ES6-B</b>
1"	1"	<b>8ES8-B</b>

E-Series Hydraulic Couplings

Straight Through Female Threaded Plugs

Body Size	Threads	Steel		Brass	
		Previous Part #	Part #	Previous Part #	Part #
1/8"	1/8" - 27 NPTF	---	<b>E1F1</b>	---	<b>E1F1-B</b>
1/4"	1/4" - 18 NPTF	STFP2	<b>E2F2</b>	STFP2B	<b>E2F2-B</b>
	1/4" - 19 BSPP	---	---	---	<b>E2BF2-B</b>
3/8"	3/8" - 18 NPTF	STFP3	<b>E3F3</b>	STFP3B	<b>E3F3-B</b>
	3/8" - 19 BSPP	---	---	---	<b>E3BF3-B</b>
1/2"	1/2" - 14 NPTF	STFP4	<b>E4F4</b>	STFP4B	<b>E4F4-B</b>
	1/2" - 14 BSPP	---	---	---	<b>E4BF4-B</b>
3/4"	3/4" - 14 NPTF	---	<b>E6F6</b>	---	<b>E6F6-B</b>
	3/4" - 14 BSPP	---	---	---	<b>E6BF6-B</b>
1"	1" - 11 1/2 NPTF	STFP8	<b>E8F8</b>	STFP8B	<b>E8F8-B</b>
	1" - 11 BSPP	---	---	---	<b>E8BF8-B</b>
1 1/4"	1 1/4" - 11 1/2 NPTF	STFP10	<b>E10F10</b>	---	<b>E10F10-B</b>
1 1/2"	1 1/2" - 11 1/2 NPTF	STFP12	<b>E12F12</b>	---	<b>E12F12-B</b>
2"	2" - 11 1/2 NPTF	STFP16	<b>E16F16</b>	---	<b>E16F16-B</b>

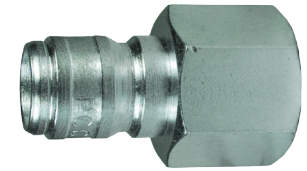

steel



brass

Hydraulic Fittings

Body Size	Threads	303 Stainless Steel	
		Previous Part #	Part #
1/8"	1/8" - 27 NPTF	---	<b>E1F1-S</b>
1/4"	1/4" - 18 NPTF	STFP2SS	<b>E2F2-S</b>
3/8"	3/8" - 18 NPTF	STFP3SS	<b>E3F3-S</b>
1/2"	1/2" - 14 NPTF	STFP4SS	<b>E4F4-S</b>
3/4"	3/4" - 14 NPTF	---	<b>E6F6-S</b>
1"	1" - 11 1/2 NPTF	STFP8SS	<b>E8F8-S</b>
1 1/4"	1 1/4" - 11 1/2 NPTF	---	<b>E10F10-S</b>
1 1/2"	1 1/2" - 11 1/2 NPTF	---	<b>E12F12-S</b>
2"	2" - 11 1/2 NPTF	---	<b>E16F16-S</b>

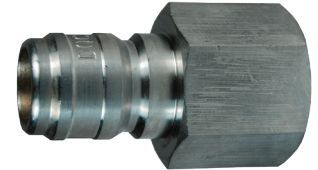

Straight Through Male Threaded Plugs

Body Size	Threads	Steel		Brass	
		Previous Part #	Part #	Previous Part #	Part #
1/8"	1/8" - 27 NPTF	---	<b>E1M1</b>	---	<b>E1M1-B</b>
1/4"	1/4" - 18 NPTF	STMP2	<b>E2M2</b>	STMP2B	<b>E2M2-B</b>
3/8"	3/8" - 18 NPTF	STMP3	<b>E3M3</b>	STMP3B	<b>E3M3-B</b>
1/2"	1/2" - 14 NPTF	STMP4	<b>E4M4</b>	STMP4B	<b>E4M4-B</b>
3/4"	3/4" - 14 NPTF	STMP6	<b>E6M6</b>	STMP6B	<b>E6M6-B</b>
1"	1" - 11 1/2 NPTF	STMP8	<b>E8M8</b>	STMP8B	<b>E8M8-B</b>
1 1/4"	1 1/4" - 11 1/2 NPTF	STMP10	<b>E10M10</b>	---	<b>E10M10-B</b>
1 1/2"	1 1/2" - 11 1/2 NPTF	STMP12	<b>E12M12</b>	---	<b>E12M12-B</b>
2"	2" - 11 1/2 NPTF	STMP16	<b>E16M16</b>	---	<b>E16M16-B</b>



steel



brass

Body Size	Threads	303 Stainless Steel	
		Previous Part #	Part #
1/8"	1/8" - 27 NPTF	---	<b>E1M1-S</b>
1/4"	1/4" - 18 NPTF	STMP2SS	<b>E2M2-S</b>
3/8"	3/8" - 18 NPTF	STMP3SS	<b>E3M3-S</b>
1/2"	1/2" - 14 NPTF	STMP4SS	<b>E4M4-S</b>
3/4"	3/4" - 14 NPTF	STMP6SS	<b>E6M6-S</b>
1"	1" - 11 1/2 NPTF	STMP8SS	<b>E8M8-S</b>



E-Series Hydraulic Couplings

Hydraulic Fittings



steel



brass

Straight Through Hose Barb Plugs

Body Size	Hose ID	Steel Part #	Brass Part #
1/4"	1/4"	<b>E2S2</b>	<b>E2S2-B</b>
3/8"	3/8"	<b>E3S3</b>	<b>E3S3-B</b>
1/2"	1/2"	<b>E4S4</b>	<b>E4S4-B</b>
3/4"	3/4"	<b>E6S6</b>	<b>E6S6-B</b>
1"	1"	<b>E8S8</b>	<b>E8S8-B</b>

Straight Through Coupler Seal Kits

Body Size	Coupler Style	Seal Kit Contents	Nitrile Part #	FKM Part #	EPDM Part #
1/4"	all	body O-ring	<b>2E-SKIT</b>	<b>F-2E-SKIT</b>	<b>P-2E-SKIT</b>
3/8"	all	body O-ring	<b>3E-SKIT</b>	<b>F-3E-SKIT</b>	<b>P-3E-SKIT</b>
1/2"	all	body O-ring	<b>4E-SKIT</b>	<b>F-4E-SKIT</b>	<b>P-4E-SKIT</b>
3/4"	all	body O-ring	<b>6E-SKIT</b>	<b>F-6E-SKIT</b>	<b>P-6E-SKIT</b>
1"	all	body O-ring	<b>8E-SKIT</b>	<b>F-8E-SKIT</b>	<b>P-8E-SKIT</b>
1 1/4"	all	body O-ring	<b>10E-SKIT</b>	<b>F-10E-SKIT</b>	<b>P-10E-SKIT</b>
1 1/2"	all	body O-ring	<b>12E-SKIT</b>	<b>F-12E-SKIT</b>	<b>P-12E-SKIT</b>
2"	all	body O-ring	<b>16E-SKIT</b>	<b>F-16E-SKIT</b>	<b>P-16E-SKIT</b>

Plug Profiles

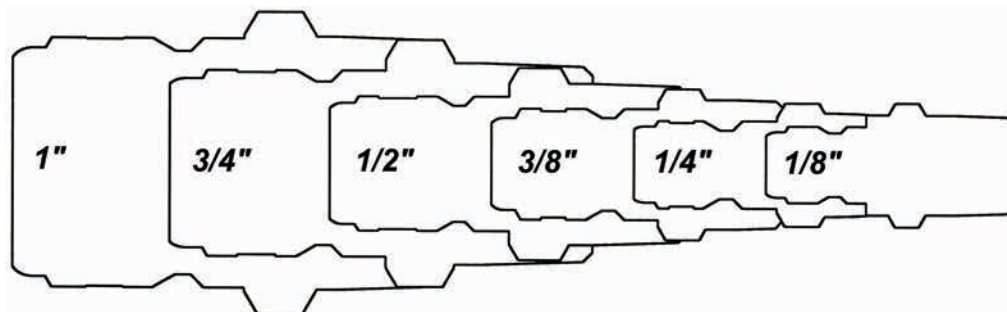

Industry/Competitor Interchange

Foster FST  
Parker ST  
Hansen ST

EA-Series Hydraulic Couplings

Features:

- plug mounted sleeve guard protects against accidental disconnection
- smooth bore full-flow design ensures maximum flow with minimal pressure drop
- steel body components maximize service life by resisting the effects of brinelling and internal erosion
- heavy duty knurled sleeve with locking pin provides maximum protection against brinelling and accidental disconnection
- nitrile (Buna-N) seals are standard, providing a temperature range of **-40°F to 250°F** (-40°C to 121°C)
- interchangeable with Parker WB, Aeroquip FD69, and Snap Tite 56
- pressure rating **10000 PSI at 70°F (21°C)**

Water-Blast Couplers

Body Size	Female Threads	Steel Part #
1/2"	3/8" - 18 NPTF	<b>4EAF3</b>
1/2"	1/2" - 14 NPTF	<b>4EAF4</b>



Water-Blast Plugs

Body Size	Female Threads	Steel Part #
1/2"	3/8" - 18 NPTF	<b>EA4F3</b>
1/2"	1/2" - 14 NPTF	<b>EA4F4</b>



Water-Blast Seal Kits

Body Size	Coupler Style	Seal Kit Contents	Nitrile Part #
1/2"	all	body O-ring and PTFE back-up	<b>4EA-SKIT</b>

Body Size	Coupler Style	Seal Kit Contents	FKM Part #
1/2"	all	body O-ring and PTFE back-up	<b>F-4EA-SKIT</b>

Body Size	Coupler Style	Seal Kit Contents	EPDM Part #
1/2"	all	body O-ring and PTFE back-up	<b>P-4EA-SKIT</b>

Plug Profile

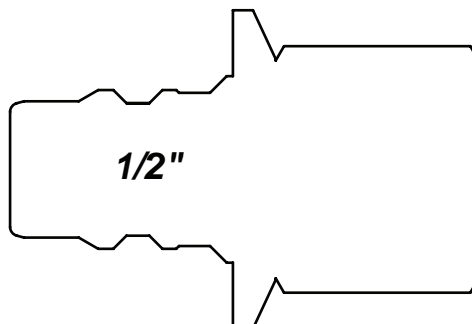

## CM-Series Hydraulic Couplings

**Features:**

- interchangeable with Foster Series- FJT, Hansen Flo-Temp, Tomco MC-Series, Parker Moldmate, DME Jiffy-Tite
- silicone gaskets and valve O-rings standard providing a temperature range **-90°F to 400°F (-68°C to 205°C)**
- Contact Dixon® for pressure ratings and other technical information.

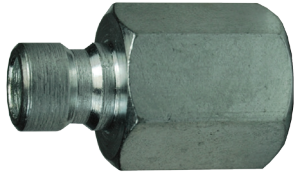
**Industrial Mold Plug Female NPTF**

steel

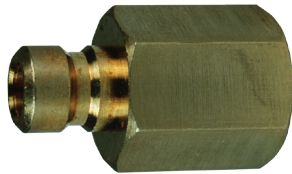

brass

Body Size	Threads	Steel Part #	Brass Part #
1/4"	1/8" - 27 NPTF	<b>CM2F1</b>	<b>CM2F1-B</b>
	1/4" - 18 NPTF	<b>CM2F2</b>	<b>CM2F2-B</b>
	3/8" - 18 NPTF	<b>CM2F3</b>	<b>CM2F3-B</b>
3/8"	1/4" - 18 NPTF	<b>CM3F2</b>	<b>CM3F2-B</b>
	3/8" - 18 NPTF	<b>CM3F3</b>	<b>CM3F3-B</b>
1/2"	1/2" - 14 NPTF	---	<b>CM4F4-B</b>
	3/4" - 14 NPTF	---	<b>CM4F6-B</b>

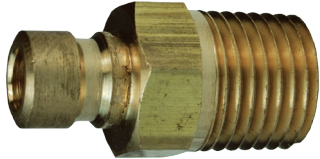
**Industrial Mold Plug Male NPTF**

Body Size	Threads	Brass Part #
1/4"	1/8" - 27 NPTF	<b>CM2M1-B</b>
	1/4" - 18 NPTF	<b>CM2M2-B</b>
	3/8" - 18 NPTF	<b>CM2M3-B</b>
3/8"	1/4" - 18 NPTF	<b>CM3M2-B</b>
	3/8" - 18 NPTF	<b>CM3M3-B</b>
	1/2" - 14 NPTF	<b>CM3M4-B</b>
1/2"	1/2" - 14 NPTF	<b>CM4M4-B</b>
	3/4" - 14 NPTF	<b>CM4M6-B</b>

**Industrial Mold Extension Plug Male NPTF**

Body Size	Threads	Brass Part #
1/4"	1/8" - 27 NPTF	<b>CM2M1-B-L2.5</b>
	1/8" - 27 NPTF	<b>CM2M1-B-L4</b>
	1/8" - 27 NPTF	<b>CM2M1-B-L5.5</b>
	1/4" - 18 NPTF	<b>CM2M2-B-L2.5</b>
	1/4" - 18 NPTF	<b>CM2M2-B-L4</b>
	1/4" - 18 NPTF	<b>CM2M2-B-L5.5</b>
	1/4" - 18 NPTF	<b>CM2M2-B-L7</b>
3/8"	1/8" - 27 NPTF	<b>CM3M1-B-L2.5</b>
	1/8" - 27 NPTF	<b>CM3M1-B-L4</b>
	1/8" - 27 NPTF	<b>CM3M1-B-L5.5</b>
	1/8" - 27 NPTF	<b>CM3M1-B-L7</b>
	1/4" - 18 NPTF	<b>CM3M2-B-L2.5</b>
	1/4" - 18 NPTF	<b>CM3M2-B-L4</b>
	1/4" - 18 NPTF	<b>CM3M2-B-L5.5</b>
	1/4" - 18 NPTF	<b>CM3M2-B-L7</b>
	1/4" - 18 NPTF	<b>CM3M2-B-L8.5</b>
	1/4" - 18 NPTF	<b>CM3M2-B-L11.5</b>



CM-Series Hydraulic Couplings

Industrial Mold Unvalved Coupler Female NPTF

Body Size	Threads	Brass Part #
1/4"	1/8" - 27 NPTF	<b>2CMF1-B-E</b>
	1/4" - 18 NPTF	<b>2CMF2-B-E</b>
3/8"	1/4" - 18 NPTF	<b>3CMF2-B-E</b>
	3/8" - 18 NPTF	<b>3CMF3-B-E</b>
1/2"	1/2" - 14 NPTF	<b>4CMF4-B-E</b>



Hydraulic Fittings

Industrial Mold Valved Coupler Female NPTF

Body Size	Threads	Brass Part #
1/4"	1/8" - 27 NPTF	<b>2CMF1-B</b>
3/8"	1/4" - 18 NPTF	<b>3CMF2-B</b>



Industrial Mold Unvalved Coupler Hose Barb

Body Size	Hose ID	Brass Part #
1/4"	1/4"	<b>2CMS2-B-E</b>
	5/16"	<b>2CMS2.5-B-E</b>
	3/8"	<b>2CMS3-B-E</b>
3/8"	3/8"	<b>3CMS3-B-E</b>
	1/2"	<b>3CMS4-B-E</b>
1/2"	1/2"	<b>4CMS4-B-E</b>
	3/4"	<b>4CMS6-B-E</b>



Industrial Mold Valved Coupler Hose Barb

Body Size	Hose ID	Brass Part #
1/4"	1/4"	<b>2CMS2-B</b>
	5/16"	<b>2CMS2.5-B</b>
	3/8"	<b>2CMS3-B</b>
3/8"	3/8"	<b>3CMS3-B</b>
	1/2"	<b>3CMS4-B</b>



Industrial Mold Unvalved Coupler Push-Loc Barb

Body Size	Hose ID	Brass Part #
1/4"	1/4"	<b>2CMB2-B-E</b>
	3/8"	<b>2CMB3-B-E</b>
3/8"	3/8"	<b>3CMB3-B-E</b>
	1/2"	<b>3CMB4-B-E</b>
1/2"	1/2"	<b>4CMB4-B-E</b>
	3/4"	<b>4CMB6-B-E</b>



Industrial Mold Valved Coupler Push-Loc Barb

Body Size	Hose ID	Brass Part #
1/4"	1/4"	<b>2CMB2-B</b>
	3/8"	<b>2CMB3-B</b>
3/8"	3/8"	<b>3CMB3-B</b>
	1/2"	<b>3CMB4-B</b>



## CM-Series Hydraulic Couplings

## Industrial Mold Unvalved Coupler 45° Hose Barb

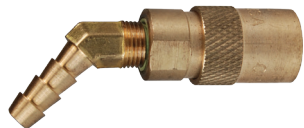

Body Size	Hose ID	Brass Part #
1/4"	1/4"	<b>2CM4S2-B-E</b>
	5/16"	<b>2CM4S2.5-B-E</b>
	3/8"	<b>2CM4S3-B-E</b>
3/8"	3/8"	<b>3CM4S3-B-E</b>
	1/2"	<b>3CM4S4-B-E</b>
1/2"	1/2"	<b>4CM4S4-B-E</b>
	3/4"	<b>4CM4S6-B-E</b>

## Industrial Mold Valved Coupler 45° Hose Barb

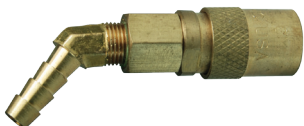

Body Size	Hose ID	Brass Part #
1/4"	1/4"	<b>2CM4S2-B</b>
	3/8"	<b>2CM4S3-B</b>
	3/8"	<b>3CM4S3-B</b>
3/8"	3/8"	<b>3CM4S3-B</b>
	1/2"	<b>3CM4S4-B</b>

## Industrial Mold Unvalved Coupler 45° Push-Loc Barb

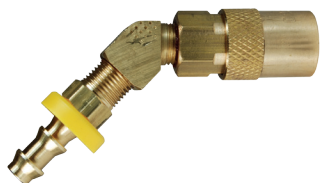

Body Size	Hose ID	Brass Part #
1/4"	1/4"	<b>2CM4B2-B-E</b>
	3/8"	<b>2CM4B3-B-E</b>
	3/8"	<b>3CM4B3-B-E</b>
3/8"	3/8"	<b>3CM4B3-B-E</b>
	1/2"	<b>3CM4B4-B-E</b>
1/2"	1/2"	<b>4CM4B4-B-E</b>
	3/4"	<b>4CM4B6-B-E</b>

## Industrial Mold Valved Coupler 45° Push-Loc Barb

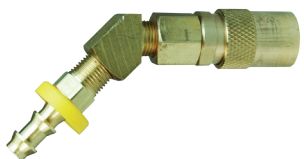

Body Size	Hose ID	Brass Part #
1/4"	1/4"	<b>2CM4B2-B</b>
	3/8"	<b>2CM4B3-B</b>
	3/8"	<b>3CM4B3-B</b>
3/8"	3/8"	<b>3CM4B3-B</b>
	1/2"	<b>3CM4B4-B</b>

## Plug Profiles

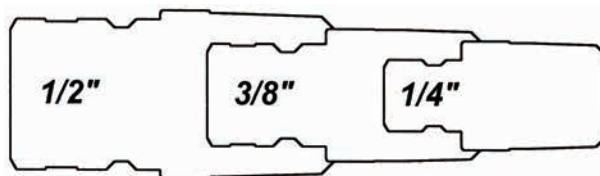

CM-Series Hydraulic Couplings

Industrial Mold Unvalved Coupler 90° Hose Barb

Body Size	Hose ID	Brass Part #
1/4"	1/4"	2CM9S2-B-E
	5/16"	2CM9S2.5-B-E
	3/8"	2CM9S3-B-E
3/8"	3/8"	3CM9S3-B-E
	1/2"	3CM9S4-B-E
1/2"	1/2"	4CM9S4-B-E
	3/4"	4CM9S6-B-E

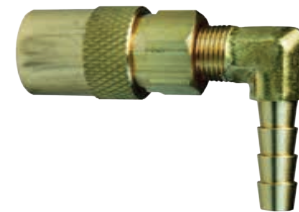

Hydraulic Fittings

Industrial Mold Valved Coupler 90° Hose Barb

Body Size	Hose ID	Brass Part #
1/4"	1/4"	2CM9S2-B
	5/16"	2CM9S2.5-B
	3/8"	2CM9S3-B
3/8"	3/8"	3CM9S3-B
	1/2"	3CM9S4-B

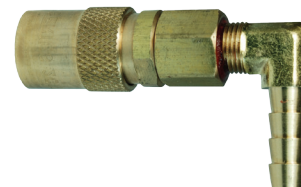

Industrial Mold Unvalved Coupler 90° Push-Loc Barb

Body Size	Hose ID	Brass Part #
1/4"	1/4"	2CM9B2-B-E
	3/8"	2CM9B3-B-E
3/8"	3/8"	3CM9B3-B-E
	1/2"	3CM9B4-B-E
1/2"	1/2"	4CM9B4-B-E
	3/4"	4CM9B6-B-E

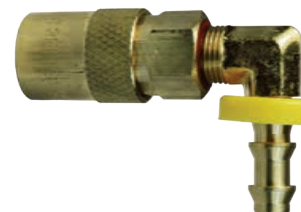

H

Industrial Mold Valved Coupler 90° Push-Loc Barb

Body Size	Hose ID	Brass Part #
1/4"	1/4"	2CM9B2-B
	3/8"	2CM9B3-B
3/8"	3/8"	3CM9B3-B
	1/2"	3CM9B4-B

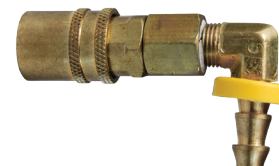

Industrial Mold Interchange Dust Plugs

Body Size	Lanyard	Brass Part #
1/4"	N/A	2CMPC-B
3/8"	N/A	3CMPC-B
1/2"	N/A	4CMPC-B



Industrial Mold Coupler Seal Kits

Body Size	Coupler Style	Seal Kit Contents	Silicone Part #
1/4"	all	body seal	2CM-SKIT
3/8"	all	body seal	3CM-SKIT
1/2"	all	body seal	4CM-SKIT

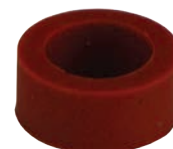

## Flat Face

## Male Unions



## Features:

- reference SAE 520101
- pressure rating at 70°F (21°C)

Male Flat Face	PSI	Zinc Plated Steel Part #
9/16"-18	6000	FS2403-4
11/16"-16	6000	FS2403-6
13/16"-16	6000	FS2403-8
1"-14	6000	FS2403-10
1-3/16"-12	6000	FS2403-12
1-7/16"-12	6000	FS2403-16

## Male x Male SAE O-ring Boss Connectors

## Features:

- reference SAE 520120
- pressure rating at 70°F (21°C)



Male Flat Face	Male SAE O-ring Boss	PSI	Zinc Plated Steel Part #
9/16"-18	7/16"-20	5000	FS6400-4-4
11/16"-16	9/16"-18	5000	FS6400-6-6
13/16"-16	3/4"-16	4500	FS6400-8-8
1"-14	7/8"-14	3500	FS6400-10-10
1-3/16"-12	1-1/16"-12	3500	FS6400-12-12
1-7/16"-12	1-5/16"-12	3000	FS6400-16-16

## Male x Male NPTF Connectors

## Features:

- reference SAE 520102
- pressure rating at 70°F (21°C)



Male Flat Face	Male NPTF	PSI	Zinc Plated Steel Part #
9/16"-18	1/4"-18	5000	FS2404-4-4
11/16"-16	3/8"-18	4000	FS2404-6-6
13/16"-16	1/2"-14	3000	FS2404-8-8
1-3/16"-12	3/4"-14	2500	FS2404-12-12
1-7/16"-12	1"-11 1/2	2000	FS2404-16-16

## Male x Female Swivel Nut 90° Elbows

## Features:

- reference SAE 520221
- pressure rating at 70°F (21°C)



Male Flat Face	Female Flat Face	PSI	Zinc Plated Steel Part #
9/16"-18	9/16"-18	6000	FS6500-4-4
11/16"-16	11/16"-16	6000	FS6500-6-6
13/16"-16	13/16"-16	6000	FS6500-8-8
1"-14	1"-14	6000	FS6500-10-10
1-3/16"-12	1-3/16"-12	6000	FS6500-12-12
1-7/16"-12	1-7/16"-12	6000	FS6500-16-16

## Male x Male SAE O-ring Boss 90° Elbows

## Features:

- reference SAE 520220
- pressure rating at 70°F (21°C)



Male Flat Face	Male SAE O-ring Boss	PSI	Zinc Plated Steel Part #
9/16"-18	7/16"-20	5000	FS6801-4-4
11/16"-16	9/16"-18	5000	FS6801-6-6
13/16"-16	3/4"-16	4500	FS6801-8-8
1"-14	7/8"-14	3500	FS6801-10-10
1-3/16"-12	1-1/16"-12	3500	FS6801-12-12
1-7/16"-12	1-5/16"-12	3000	FS6801-16-16

## Flat Face Male x Male NPTF 90° Elbows

**Features:**

- reference SAE 520202
- pressure rating at **70°F (21°C)**

Male Flat Face	Male NPTF	PSI	Zinc Plated Steel Part #
9/16"-18	¼"-18	<b>5000</b>	<b>FS2501-4-4</b>
11/16"-16	⅜"-18	<b>4000</b>	<b>FS2501-6-6</b>
13/16"-16	½"-14	<b>3000</b>	<b>FS2501-8-8</b>
1-3/16"-12	¾"-14	<b>2500</b>	<b>FS2501-12-12</b>
1-7/16"-12	1"-11½	<b>2000</b>	<b>FS2501-16-16</b>



## Male Union Tees

**Features:**

- reference SAE 520401
- pressure rating at **70°F (21°C)**

Male Flat Face	Male Flat Face	Male Flat Face	PSI	Zinc Plated Steel Part #
9/16"-18	9/16"-18	9/16"-18	<b>6000</b>	<b>FS2603-4</b>
11/16"-16	11/16"-16	11/16"-16	<b>6000</b>	<b>FS2603-6</b>
13/16"-16	13/16"-16	13/16"-16	<b>6000</b>	<b>FS2603-8</b>
1"-14	1"-14	1"-14	<b>6000</b>	<b>FS2603-10</b>
1-3/16"-12	1-3/16"-12	1-3/16"-12	<b>6000</b>	<b>FS2603-12</b>
1-7/16"-12	1-7/16"-12	1-7/16"-12	<b>6000</b>	<b>FS2603-16</b>



## Male x Female Swivel x Male Run Tees

**Features:**

- reference SAE 520432
- pressure rating at **70°F (21°C)**

Male Flat Face	Female Flat Face Swivel	Male Flat Face	PSI	Zinc Plated Steel Part #
9/16"-18	9/16"-18	9/16"-18	<b>4500</b>	<b>FS6602-4</b>
11/16"-16	11/16"-16	11/16"-16	<b>4000</b>	<b>FS6602-6</b>
13/16"-16	13/16"-16	13/16"-16	<b>4000</b>	<b>FS6602-8</b>
1"-14	1"-14	1"-14	<b>3000</b>	<b>FS6602-10</b>
1-3/16"-12	1-3/16"-12	1-3/16"-12	<b>3000</b>	<b>FS6602-12</b>
1-7/16"-12	1-7/16"-12	1-7/16"-12	<b>2500</b>	<b>FS6602-16</b>



## Caps

**Features:**

- reference SAE 520112
- pressure rating at **70°F (21°C)**

Female Flat Face	PSI	Zinc Plated Steel Part #
9/16"-18	<b>6000</b>	<b>FS304C-4</b>
11/16"-16	<b>6000</b>	<b>FS304C-6</b>
13/16"-16	<b>6000</b>	<b>FS304C-8</b>
1"-14	<b>6000</b>	<b>FS304C-10</b>
1-3/16"-12	<b>6000</b>	<b>FS304C-12</b>
1-7/16"-12	<b>6000</b>	<b>FS304C-16</b>



## Plugs

**Features:**

- reference SAE 520109
- pressure rating at **70°F (21°C)**

Male Flat Face	PSI	Zinc Plated Steel Part #
9/16"-18	<b>6000</b>	<b>FS2408-4</b>
11/16"-16	<b>6000</b>	<b>FS2408-6</b>
13/16"-16	<b>6000</b>	<b>FS2408-8</b>
1"-14	<b>6000</b>	<b>FS2408-10</b>
1-3/16"-12	<b>6000</b>	<b>FS2408-12</b>
1-7/16"-12	<b>6000</b>	<b>FS2408-16</b>



## O-ring Boss

## Port Reducers

## Feature:

- pressure rating at 70°F (21°C)



Male SAE O-ring Boss	Female O-ring Port	PSI	Zinc Plated Steel Part #
9/16"-18	7/16"-20	5000	6410-6-4
9/16"-18	3/4"-16	4500	6410-6-8
3/4"-16	7/8"-14	3500	6410-8-10
3/4"-16	9/16"-18	4500	6410-8-6
7/8"-14	1-1/16"-12	3500	6410-10-12
7/8"-14	3/4"-16	3500	6410-10-8
1-1/16"-12	7/8"-14	3000	6410-12-10
1-1/16"-12	1-5/16"-12	3000	6410-12-16

## Adjustable Unions

## Feature:

- pressure rating at 70°F (21°C)



Male O-ring Boss	Adjustable O-ring Boss	PSI	Zinc Plated Steel Part #
7/16"-20	7/16"-20	4500	6403-4
9/16"-18	9/16"-18	4000	6403-6
3/4"-16	3/4"-16	4000	6403-8
7/8"-14	7/8"-14	3000	6403-10
1-1/16"-12	1-1/16"-12	3000	6403-12
1-5/16"-12	1-5/16"-12	2500	6403-16

## Male JIC x Male SAE

## Features:

- reference SAE 070120
- pressure rating at 70°F (21°C)

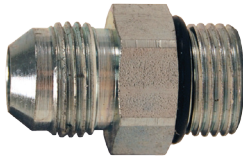

Male JIC	Male SAE O-ring Boss	PSI	Zinc Plated Steel Part #
7/16"-20	7/16"-20	5000	1231-04-04
7/16"-20	9/16"-18	5000	1231-04-06
7/16"-20	3/4"-16	4500	1231-04-08
1/2"-20	1/2"-20	5000	1231-05-05
9/16"-18	7/16"-20	5000	1231-06-04
9/16"-18	9/16"-18	5000	1231-06-06
9/16"-18	3/4"-16	4500	1231-06-08
9/16"-18	7/8"-14	3500	1231-06-10
3/4"-16	9/16"-18	4500	1231-08-06
3/4"-16	3/4"-16	4500	1231-08-08
3/4"-16	7/8"-14	3500	1231-08-10
3/4"-16	1-1/16"-12	3500	1231-08-12
7/8"-14	3/4"-16	3500	1231-10-08
7/8"-14	7/8"-14	3500	1231-10-10
7/8"-14	1-1/16"-12	3500	1231-10-12
1-1/16"-12	7/8"-14	3500	1231-12-10
1-1/16"-12	1-1/16"-12	3500	1231-12-12
1-1/16"-12	1-5/16"-12	3000	1231-12-16
1-5/16"-12	1-1/16"-12	3000	1231-16-12
1-5/16"-12	1-5/16"-12	3000	1231-16-16
1-5/16"-12	1 5/8"-12	2500	1231-16-20
1 5/8"-12	1-5/16"-12	2500	1231-20-16
1 5/8"-12	1 5/8"-12	2500	1231-20-20

## Male x Male NPTF

## Feature:

- pressure rating at 70°F (21°C)



Male SAE O-ring Boss	Male NPTF Pipe Adapter	PSI	Zinc Plated Steel Part #
7/16"-20	1/4"-18	5000	6401-4-4
9/16"-18	1/4"-18	4000	6401-6-4
9/16"-18	3/8"-18	4000	6401-6-6
9/16"-18	1/2"-14	3000	6401-6-8
3/4"-16	3/8"-18	3000	6401-8-6
3/4"-16	1/2"-14	3000	6401-8-8
7/8"-14	1/2"-14	3000	6401-10-8
1-1/16"-12	3/4"-14	2500	6401-12-12
1-5/16"-12	1"-11 1/2	2000	6401-16-16

## O-ring Boss (ORB)

## Male x Female NPTF

## Feature:

- pressure rating at **70°F (21°C)**

Male SAE O-ring Boss	Female NPTF Pipe	PSI	Zinc Plated Steel Part #
7/16"-20	1/8"-27	5000	6405-4-2
7/16"-20	1/4"-18	5000	6405-4-4
7/16"-20	3/8"-18	4000	6405-4-6
9/16"-18	1/4"-18	4000	6405-6-4
9/16"-18	3/8"-18	4000	6405-6-6
9/16"-18	1/2"-14	3000	6405-6-8
3/4"-16	3/8"-18	4000	6405-8-6
3/4"-16	1/2"-14	3000	6405-8-8
7/8"-14	1/4"-18	3000	6405-10-4
7/8"-14	1/2"-14	3000	6405-10-8
7/8"-14	3/4"-14	2500	6405-10-12
1-1/16"-12	1/2"-14	3000	6405-12-8
1-1/16"-12	3/4"-14	2500	6405-12-12
1-1/16"-12	1"-11 1/2	2000	6405-12-16
1-5/16"-12	3/4"-14	2500	6405-16-12
1-5/16"-12	1"-11 1/2	2000	6405-16-16
1-5/16"-12	1 1/4"-11 1/2	1150	6405-16-20
1 5/8"-12	1"-11 1/2	2000	6405-20-16
1 5/8"-12	1 1/4"-11 1/2	1150	6405-20-20

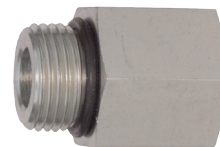

Hydraulic Fittings

## 90° Male SAE x Male JIC Elbows

## Features:

- reference SAE 070220
- pressure rating at **70°F (21°C)**

Male SAE O-ring Boss	Male JIC	PSI	Zinc Plated Steel Part #
7/16"-20	7/16"-20	5000	1238-04-04
7/16"-20	9/16"-18	5000	1238-04-06
9/16"-18	7/16"-20	5000	1238-06-04
9/16"-18	9/16"-18	5000	1238-06-06
3/4"-16	9/16"-18	4500	1238-08-06
3/4"-16	3/4"-16	4500	1238-08-08
3/4"-16	7/8"-14	3500	1238-08-10
7/8"-14	3/4"-16	3500	1238-10-08
7/8"-14	7/8"-14	3500	1238-10-10
7/8"-14	1-1/16"-12	3500	1238-10-12
1-1/16"-12	7/8"-14	3500	1238-12-10
1-1/16"-12	1-1/16"-12	3500	1238-12-12
1-1/16"-12	1-5/16"-12	3000	1238-12-16
1-5/16"-16	1-1/16"-12	3000	1238-16-12
1-5/16"-12	1-5/16"-12	3000	1238-16-16
1 5/8"-12	1-5/16"-12	2500	1238-20-16
1 5/8"-12	1 5/8"-12	2500	1238-20-20
1 7/8"-12	1 7/8"-12	2000	1238-24-24



## 90° SAE x Female NPSM Swivel Nut Elbows

## Features:

- reference SAE 140257
- pressure rating at **70°F (21°C)**

Male SAE O-ring Boss	Female NPSM Swivel	PSI	Zinc Plated Steel Part #
7/16"-20	1/4"-18	4500	6901-4-4
7/16"-20	3/8"-18	4000	6901-4-6
9/16"-18	1/4"-18	4000	6901-6-4
9/16"-18	3/8"-18	4000	6901-6-6
9/16"-18	1/2"-14	4000	6901-6-8
3/4"-16	3/8"-18	3500	6901-8-6
3/4"-16	1/2"-14	4000	6901-8-8
3/4"-16	3/4"-14	3000	6901-8-12
7/8"-14	1/2"-14	3500	6901-10-8
7/8"-14	3/4"-14	3000	6901-10-12
1-1/16"-12	1/2"-14	3500	6901-12-8
1-1/16"-12	3/4"-14	3000	6901-12-12
1-1/16"-12	1"-11 1/2	2500	6901-12-16
1-5/16"-12	3/4"-14	3000	6901-16-12
1-5/16"-12	1"-11 1/2	2500	6901-16-16
1-5/16"-12	1 1/4"-11 1/2	2000	6901-16-20
1 5/8"-12	1 1/4"-11 1/2	2000	6901-20-20



## O-ring Boss (ORB) 45° Male SAE x Male JIC Elbows

**Features:**

- reference SAE 070320
- pressure rating at **70°F (21°C)**



Male SAE O-ring Boss	Male JIC	PSI	Zinc Plated Steel Part #
7/16"-20	7/16"-20	5000	1240-04-04
9/16"-18	9/16"-18	5000	1240-06-06
9/16"-18	3/4"-16	4500	1240-06-08
3/4"-16	9/16"-18	4500	1240-08-06
3/4"-16	3/4"-16	4500	1240-08-08
3/4"-16	7/8"-14	3500	1240-08-10
7/8"-14	3/4"-16	3500	1240-10-08
7/8"-14	7/8"-14	3500	1240-10-10
7/8"-14	1-1/16"-12	3500	1240-10-12
1-1/16"-12	7/8"-14	3500	1240-12-10
1-1/16"-12	1-1/16"-12	3500	1240-12-12
1-1/16"-12	1-5/16"-12	3000	1240-12-16
1-5/16"-12	1-5/16"-12	3000	1240-16-16
1 5/8"-12	1-5/16"-12	2500	1240-20-16
1 5/8"-12	1 5/8"-12	2500	1240-20-20

## Male 37° Flare x Male Branch Tees

**Features:**

- reference SAE 070429
- pressure rating at **70°F (21°C)**



(2) Male JIC 37°	Male SAE O-ring Boss	PSI	Zinc Plated Steel Part #
7/16"-20	7/16"-20	5000	6803-4
9/16"-18	9/16"-18	5000	6803-6
3/4"-16	3/4"-16	4500	6803-8
7/8"-14	7/8"-14	3500	6803-10
1-1/16"-12	1-1/16"-12	3500	6803-12
1-5/16"-12	1-5/16"-12	3000	6803-16

## SAE Plugs

**Features:**

- reference SAE 090109A
- pressure rating at **70°F (21°C)**



Male SAE O-ring Boss	PSI	Zinc Plated Steel Part #
7/16"-20	5000	1255-04H
9/16"-18	5000	1255-06H
3/4"-16	4500	1255-08H
7/8"-14	3500	1255-10H
1-1/16"-12	3500	1255-12H
1-5/16"-12	3000	1255-16H
1 5/8"-12	2500	1255-20H
1 7/8"-12	2000	1255-24H
2 1/2"-12	1500	1255-32H

## Hollow Hex Plugs

**Features:**

- reference SAE 090109B
- requires Allen wrench
- pressure rating at **70°F (21°C)**

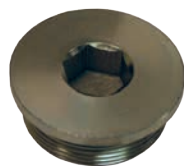

Male SAE O-ring Boss	PSI	Zinc Plated Steel Part #
7/16"-20	5000	6408HHP-4
9/16"-18	5000	6408HHP-6
3/4"-16	4500	6408HHP-8
7/8"-14	3500	6408HHP-10
1-1/16"-12	3500	6408HHP-12
1-5/16"-12	3000	6408HHP-16
1 5/8"-12	2500	6408HHP-20
1 7/8"-12	1500	6408HHP-24
2 1/2"-12	1500	6408HHP-32



## 37° JIC

Male x Male

## Features:

- reference SAE 070101
- pressure rating at **70°F (21°C)**

Male JIC 37°	Male JIC 37°	PSI	Zinc Plated Steel Part #
7/16"-20	7/16"-20	5000	1204-04-04
9/16"-18	9/16"-18	5000	1204-06-06
3/4"-16	7/16"-20	4500	1204-08-04
3/4"-16	3/4"-16	4500	1204-08-08
7/8"-14	3/4"-16	3500	1204-10-08
7/8"-14	7/8"-14	3500	1204-10-10
1-1/16"-12	3/4"-16	3500	1204-12-08
1-1/16"-12	7/8"-14	3500	1204-12-10
1-1/16"-12	1-1/16"-12	3500	1204-12-12
1-5/16"-12	1-1/16"-12	3000	1204-16-12
1-5/16"-12	1-5/16"-12	3000	1204-16-16
1 5/8"-12	1 5/8"-12	2500	1204-20-20
1 7/8"-12	1 7/8"-12	2000	1204-24-24



Hydraulic Fittings

## Male Flare x Male NPTF

## Features:

- reference SAE 070102
- pressure rating at **70°F (21°C)**

Male JIC 37° Flare	Male NPTF	PSI	Zinc Plated Steel Part #	316 Stainless Steel Part #
7/16"-20	1/8"-27	4500	2404-4-2	---
7/16"-20	1/4"-18	4500	2404-4-4	SS2404-4-4
7/16"-20	3/8"-18	4000	2404-4-6	---
7/16"-20	1/2"-18	3000	2404-4-8	---
1/2"-20	1/8"-27	4000	2404-5-2	---
9/16"-18	1/8"-27	4000	2404-6-2	---
9/16"-18	1/4"-18	4000	2404-6-4	---
9/16"-18	3/8"-18	4000	2404-6-6	SS2404-6-6
9/16"-18	1/2"-14	3000	2404-6-8	---
3/4"-16	1/4"-18	4000	2404-8-4	---
3/4"-16	3/8"-18	4000	2404-8-6	---
3/4"-16	1/2"-14	3000	2404-8-8	SS2404-8-8
3/4"-16	3/4"-14	2500	2404-8-12	---
7/8"-14	1/2"-14	3000	2404-10-8	---
7/8"-14	3/4"-14	2500	2404-10-12	---
1-1/16"-12	1/2"-14	3000	2404-12-8	---
1-1/16"-12	3/4"-14	2500	2404-12-12	SS2404-12-12
1-1/16"-12	1"-11 1/2	2000	2404-12-16	---
1-5/16"-12	3/4"-14	2500	2404-16-12	---
1-5/16"-12	1"-11 1/2	2000	2404-16-16	SS2404-16-16
1 5/8"-12	1 1/4"-11 1/2	1150	2404-20-20	---
1 7/8"-12	1 1/2"-11 1/2	1000	2404-24-24	---
2 1/2"-12	2"-11 1/2	1000	2404-32-32	---

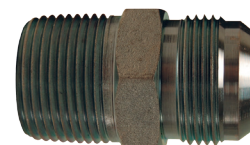

## Male Flare x Female NPTF

## Features:

- reference SAE 070103
- pressure rating at **70°F (21°C)**

Male JIC 37° Flare	Female NPTF	PSI	Zinc Plated Steel Part #	316 Stainless Steel Part #
7/16"-20	1/8"-27	4500	2405-4-2	---
7/16"-20	1/4"-18	4500	2405-4-4	SS2405-4-4
9/16"-18	1/4"-18	4000	2405-6-4	---
9/16"-18	3/8"-18	4000	2405-6-6	SS2405-6-6
9/16"-18	1/2"-14	3000	2405-6-8	---
3/4"-16	3/8"-18	4000	2405-8-6	---
3/4"-16	1/2"-14	3000	2405-8-8	SS2405-8-8
3/4"-16	3/4"-14	2500	2405-8-12	---
7/8"-14	1/2"-14	3000	2405-10-8	---
1-1/16"-12	3/4"-14	2500	2405-12-12	SS2405-12-12
1-1/16"-12	1"-11 1/2	2000	2405-12-16	---
1-5/16"-12	1"-11 1/2	2000	2405-16-16	SS2405-16-16
1 5/8"-12	1 1/4"-11 1/2	1150	2405-20-20	---



## 37° JIC

## Female Swivel x Male NPTF

## Feature:

- pressure rating at 70°F (21°C)

Female JIC 37° Swivel	Male NPTF Pipe	PSI	Zinc Plated Steel Part #
7/16"-20	1/8"-27	4500	6505-4-2
7/16"-20	1/4"-18	4500	6505-4-4
1/2"-20	1/4"-18	4000	6505-5-4
9/16"-18	1/4"-18	4000	6505-6-4
9/16"-18	3/8"-18	4000	6505-6-6
3/4"-16	3/8"-18	4000	6505-8-6
3/4"-16	1/2"-14	3000	6505-8-8
7/8"-14	1/2"-14	3000	6505-10-8
7/8"-14	3/4"-14	2500	6505-10-12
1-1/16"-12	1/2"-14	3000	6505-12-8
1-1/16"-12	3/4"-14	2500	6505-12-12
1-5/16"-12	3/4"-14	2500	6505-16-12
1-5/16"-12	1"-1/2	2000	6505-16-16
1 5/8"-12	1 1/4"-11 1/2	1150	6505-20-20
1 7/8"-12	1 1/2"-11 1/2	1000	6505-24-24
2 1/2"-12	2"-11 1/2	1000	6505-32-32



Hydraulic Fittings

## Female Swivel x Female NPTF

## Feature:

- pressure rating at 70°F (21°C)

Female JIC 37° Swivel	Female NPTF	PSI	Zinc Plated Steel Part #
7/16"-20	1/4"-18	4500	6506-4-4
7/16"-20	3/8"-18	4000	6506-4-6
9/16"-18	1/4"-18	4000	6506-6-4
9/16"-18	3/8"-18	4000	6506-6-6
3/4"-16	1/2"-14	3000	6506-8-8
7/8"-14	1/2"-14	3000	6506-10-8
1-1/16"-12	3/4"-14	2500	6506-12-12
1-5/16"-12	1" 11/2	2000	6506-16-16



## 90° Male Flare Elbows

## Features:

- reference SAE 070201
- pressure rating at 70°F (21°C)

Male JIC 37° Flare	Male JIC 37° Flare	PSI	Zinc Plated Steel Part #
7/16"-20	7/16"-20	5000	1234-04-04
9/16"-18	9/16"-18	5000	1234-06-06
3/4"-16	3/4"-16	4500	1234-08-08
7/8"-14	7/8"-14	3500	1234-10-10
1-1/16"-12	1-1/16"-12	3500	1234-12-12
1-5/16"-12	1-5/16"-12	3000	1234-16-16
1 5/8"-12	1 5/8"-12	2500	1234-20-20



## 90° Male Flare x Female Flare Swivel Elbows

## Features:

- reference SAE 070221
- pressure rating at 70°F (21°C)

Male 37° JIC Flare	Female 37° JIC Swivel	PSI	Zinc Plated Steel Part #
7/16"-20	7/16"-20	5000	6500-4
9/16"-18	9/16"-18	5000	6500-6
9/16"-18	7/16"-20	5000	6500-6-4
9/16"-18	3/4"-16	4500	6500-6-8
3/4"-16	3/4"-16	4500	6500-8
3/4"-16	9/16"-18	4500	6500-8-6
3/4"-16	7/8"-14	3500	6500-8-10
7/8"-14	7/8"-14	3500	6500-10
1-1/16"-12	1-1/16"-12	3500	6500-12
1-1/16"-12	7/8"-14	3500	6500-12-10
1-5/16"-12	1-5/16"-12	3000	6500-16
1 5/8"-12	1 5/8"-12	2500	6500-20



## 37° JIC

## 90° Male Flare x Male NPTF Elbows

## Features:

- reference SAE 070202
- pressure rating at **70°F (21°C)**

Male JIC 37° Flare	Male NPTF	PSI	Zinc Plated Steel Part #	316 Stainless Steel Part #
7/16"-20	1/8"-27	4500	2501-4-2	---
7/16"-20	1/4"-18	4500	2501-4-4	SS2501-4-4
7/16"-20	3/8"-18	4000	2501-4-6	---
9/16"-18	1/8"-27	4000	2501-6-2	---
9/16"-18	1/4"-18	4000	2501-6-4	---
9/16"-18	3/8"-18	4000	2501-6-6	SS2501-6-6
9/16"-18	1/2"-14	3000	2501-6-8	---
3/4"-16	1/4"-18	4000	2501-8-4	---
3/4"-16	3/8"-18	4000	2501-8-6	---
3/4"-16	1/2"-14	3000	2501-8-8	SS2501-8-8
3/4"-16	3/4"-14	2500	2501-8-12	---
7/8"-14	1/2"-14	3000	2501-10-8	---
7/8"-14	3/4"-14	2500	2501-10-12	---
1-1/16"-12	1/2"-14	3000	2501-12-8	---
1-1/16"-12	3/4"-14	2500	2501-12-12	SS2501-12-12
1-1/16"-12	1"-11 1/2	2000	2501-12-16	---
1-5/16"-12	3/4"-14	2500	2501-16-12	---
1-5/16"-12	1"-11 1/2	2000	2501-16-16	SS2501-16-16
1 5/8"-12	1"-11 1/2	2000	2501-20-16	---
1 5/8"-12	1 1/4"-11 1/2	1150	2501-20-20	---
1 7/8"-12	1 1/2"-11 1/2	1000	2501-24-24	---
2 1/2"-12	2"-11 1/2	1000	2501-32-32	---



## 90° Female Swivel x Male NPTF Elbows

## Feature:

- pressure rating at **70°F (21°C)**

Female JIC 37° Swivel	Male NPTF	PSI	Zinc Plated Steel Part #
7/16"-20	1/8"-27	4500	6501-4-2
7/16"-20	1/4"-18	4500	6501-4-4
1/2"-20	1/8"-27	4000	6501-5-2
9/16"-18	1/4"-18	4000	6501-6-4
9/16"-18	3/8"-18	4000	6501-6-6
3/4"-16	3/8"-18	4000	6501-8-6
3/4"-16	1/2"-14	3000	6501-8-8
7/8"-14	1/2"-14	3000	6501-10-8
1-1/16"-12	3/4"-14	2500	6501-12-12
1-3/16"-12	3/4"-14	2500	6501-14-12
1-5/16"-12	1"-11 1/2	2000	6501-16-16
1 5/8"-12	1 1/4"-11 1/2	1150	6501-20-20
1 7/8"-12	1 1/2"-11 1/2	1000	6501-24-24
2 1/2"-12	2"-11 1/2	1000	6501-32-32



## 45° Male Flare x Female Swivel Elbows

## Features:

- reference SAE 070321
- pressure rating at **70°F (21°C)**

Male JIC 37°	Female JIC 37° Swivel	PSI	Zinc Plated Steel Part #
7/16"-20	7/16"-20	4500	6502-4
9/16"-18	9/16"-18	4000	6502-6
3/4"-16	3/4"-16	4000	6502-8
7/8"-14	7/8"-14	3000	6502-10
1 1/16"-12	1 1/16"-12	3000	6502-12
1 5/16"-12	1 5/16"-12	2500	6502-16
1 5/8"-12	1 5/8"-12	2000	6502-20



## 37° JIC

## 45° Male Flare x Male NPTF Elbows

## Features:

- reference SAE 070302
- pressure rating at 70°F (21°C)



Male JIC 37° Flare	Male NPTF	PSI	Zinc Plated Steel Part #
7/16"-20	1/8"-27	4500	2503-4-2
7/16"-20	1/4"-18	4500	2503-4-4
9/16"-18	1/4"-18	4000	2503-6-4
9/16"-18	3/8"-18	4000	2503-6-6
3/4"-16	1/4"-18	4000	2503-8-4
3/4"-16	3/8"-18	4000	2503-8-6
3/4"-16	1/2"-14	3000	2503-8-8
7/8"-14	1/2"-14	3000	2503-10-8
7/8"-14	3/4"-14	2500	2503-10-12
1-1/16"-12	3/4"-14	2500	2503-12-12
1-5/16"-12	3/4"-14	2500	2503-16-12
1-5/16"-12	1"-11 1/2	2000	2503-16-16

## Male Flare Union Tees

## Features:

- reference SAE 070401
- pressure rating at 70°F (21°C)



Male JIC 37° Flare (3)	PSI	Zinc Plated Steel Part #
7/16"-20	5000	2603-4
9/16"-18	5000	2603-6
3/4"-16	4500	2603-8
7/8"-14	3500	2603-10
1-1/16"-12	3500	2603-12
1-5/16"-12	3000	2603-16

## Male Flare x Female Swivel Tees

## Features:

- reference SAE 070433
- pressure rating at 70°F (21°C)



Male JIC 37° Flare (2)	Female JIC 37° Swivel	PSI	Zinc Plated Steel Part #
7/16"-20	7/16"-20	4500	6600-4
9/16"-18	9/16"-18	4000	6600-6
3/4"-16	3/4"-16	4000	6600-8
1 1/16"-12	1 1/16"-12	3000	6600-12
1 5/16"-12	1 5/16"-12	2500	6600-16

## Male Flare x Female Swivel Branch Tees

## Features:

- reference SAE 070432
- pressure rating at 70°F (21°C)



Male JIC 37° Flare (2)	Female JIC 37° Swivel	PSI	Zinc Plated Steel Part #
7/16"-20	7/16"-20	4500	6602-4
9/16"-18	9/16"-18	4000	6602-6
3/4"-16	3/4"-16	4000	6602-8
7/8"-14	7/8"-14	3000	6602-10
1-1/16"-12	1-1/16"-12	3000	6602-12
1-5/16"-12	1-5/16"-12	2500	6602-16
1 5/8"-12	1 5/8"-12	2000	6602-20

## Male Flare x Male NPTF Branch Tees

## Features:

- reference SAE070425
- pressure rating at 70°F (21°C)



Male JIC 37° Flare (2)	Male NPTF	PSI	Zinc Plated Steel Part #
7/16"-20	1/4"-18	5000	2601-4-4-4
9/16"-18	1/4"-18	5000	2601-6-6-4
9/16"-18	3/8"-18	4000	2601-6-6-6
3/4"-16	1/2"-14	3000	2601-8-8-8
7/8"-14	1/2"-14	3000	2601-10-10-8
1-1/16"-12	3/4"-14	2500	2601-12-12-12
1-5/16"-12	1"-11 1/2	2000	2601-16-16-16

## 37° JIC

## Flare Caps

## Features:

- reference SAE 070112
- pressure rating at **70°F (21°C)**

Female JIC 37° Flare	Tube OD	PSI	Zinc Plated Steel Part #
5/16"-24	1/8"	5000	0304C-2
7/16"-20	1/4"	5000	0304C-4
9/16"-18	3/8"	5000	0304C-6
3/4"-16	1/2"	4500	0304C-8
7/8"-14	5/8"	3500	0304C-10
1-1/16"-12	3/4"	3500	0304C-12
1-5/16"-12	1"	3000	0304C-16
1 5/8"-12	1 1/4"	2500	0304C-20
1 7/8"-12	1 1/2"	2000	0304C-24
2 1/2"-12	2"	1500	0304C-32

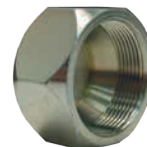

## Flare Tube Nuts

## Features:

- reference SAE 070110
- pressure rating at **70°F (21°C)**

Female JIC 37° Flare	Tube OD	PSI	Zinc Plated Steel Part #
7/16"-20	1/4"	5000	0318-4
9/16"-18	3/8"	5000	0318-6
3/4"-16	1/2"	4500	0318-8
7/8"-14	5/8"	3500	0318-10
1-1/16"-12	3/4"	3500	0318-12
1-5/16"-12	1"	3000	0318-16



## Screw Thread Plugs

## Features:

- reference SAE 070109
- pressure rating at **70°F (21°C)**

Male JIC 37° Flare	PSI	Zinc Plated Steel Part #
5/16"-24	5000	1254-02H
7/16"-20	5000	1254-04H
9/16"-18	5000	1254-06H
3/4"-16	4500	1254-08H
7/8"-14	3500	1254-10H
1-1/16"-12	3500	1254-12H
1-5/16"-12	3000	1254-16H
1 5/8"-12	2500	1254-20H



## Flare Tube Sleeves

## Features:

- reference SAE 070115
- pressure rating at **70°F (21°C)**

Female JIC 37° Flare	PSI	Zinc Plated Steel Part #
7/16"-20	5000	0319-4
9/16"-18	5000	0319-6
3/4"-16	4500	0319-8
7/8"-14	3500	0319-10
1-1/16"-12	3500	0319-12
1-5/16"-12	3000	0319-16



## Flare Bulkhead Unions with Lock Nut

## Features:

- reference SAE 070601
- pressure rating at **70°F (21°C)**

Male JIC 37° Flare	PSI	Zinc Plated Steel Part #
7/16"-20	5000	2700LN-4
9/16"-18	5000	2700LN-6
3/4"-16	4500	2700LN-8
7/8"-14	3500	2700LN-10
1-1/16"-12	3500	2700LN-12
1-5/16"-12	3000	2700LN-16

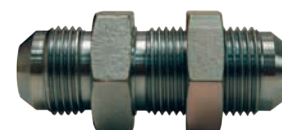

## 37° JIC

## Flare 90° Bulkhead Elbow with Lock Nuts

## Features:

- reference SAE 070701
- pressure rating at 70°F (21°C)



Male JIC 37° Flare	PSI	Zinc Plated Steel Part #
7/16"-20	5000	2701LN-4
9/16"-18	5000	2701LN-6
3/4"-16	4500	2701LN-8
7/8"-14	3500	2701LN-10
1-1/16"-12	3500	2701LN-12
1-5/16"-12	3000	2701LN-16

## Flare Bulkhead Lock Nuts

## Features:

- reference SAE 070118
- pressure rating at 70°F (21°C)



Female JIC 37° Bulkhead	Tube OD	PSI	Zinc Plated Steel Part #
7/16"-20	1/4"	5000	0306-4
9/16"-18	3/8"	5000	0306-6
3/4"-16	1/2"	4500	0306-8
7/8"-14	5/8"	3500	0306-10
1-1/16"-12	3/4"	3500	0306-12
1-5/16"-12	1"	3000	0306-16

## Weld End Metal Hose Fittings

### Straight Female

All fittings have 316 seamless stainless steel tubes

**Feature:**

- pressure rating at 70°F (21°C)

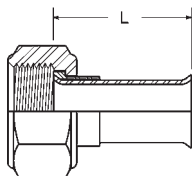

Female SAE 37° JIC	Tube OD	Pressure Rating PSI at 70°F (21°)	Dimension L		Tube Wall	304 Stainless Steel Nut & Sleeve Part #	Carbon Steel Nut & Sleeve Part #
7/16" - 20	1/4"	<b>8650</b>	1.500"		.049"	<b>SFMF250</b>	<b>FMF250</b>
9/16" - 18	3/8"	<b>5550</b>	1.500"		.049"	<b>SFMF375</b>	<b>FMF375</b>
3/4" - 16	1/2"	<b>4050</b>	1.500"		.049"	<b>SFMF500</b>	<b>FMF500</b>
1-1/16" - 12	3/4"	<b>2600</b>	1.500"		.049"	<b>SFMF750</b>	<b>FMF750</b>
1-5/16" - 12	1"	<b>1950</b>	2.000"		.049"	<b>SFMF1000</b>	<b>FMF1000</b>
1 5/8" - 12	1 1/4"	<b>2050</b>	2.375"		.065"	<b>SFMF1250</b>	<b>FMF1250</b>
1 7/8" - 12	1 1/2"	<b>1700</b>	2.375"		.065"	<b>SFMF1500</b>	<b>FMF1500</b>
2 1/2" - 12	2"	<b>1250</b>	2.500"		.065"	<b>SFMF2000</b>	<b>FMF2000</b>

### 45° Elbow Female

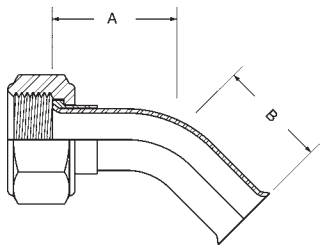

Female SAE 37° JIC	Tube OD	Pressure Rating PSI at 70°F (21°)	Dimension		Bend Radius	Tube Wall	304 Stainless Steel Nut & Sleeve Part #	Carbon Steel Nut & Sleeve Part #
			A	B				
7/16" - 20	1/4"	<b>5000</b>	0.750"	0.750"	0.380"	.049"	---	<b>FMF250-45</b>
9/16" - 18	3/8"	<b>4500</b>	1.000"	1.000"	0.500"	.049"	---	<b>FMF375-45</b>
3/4" - 16	1/2"	<b>4000</b>	1.250"	1.250"	1.000"	.049"	<b>SFMF500-45</b>	<b>FMF500-45</b>
1-1/16" - 12	3/4"	<b>2600</b>	1.450"	1.450"	1.500"	.049"	<b>SFMF750-45</b>	---
1-5/16" - 12	1"	<b>2500</b>	1.800"	1.800"	2.000"	.049"	<b>SFMF1000-45</b>	<b>FMF1000-45</b>
1 5/8" - 12	1 1/4"	<b>2050</b>	2.100"	2.100"	2.000"	.065"	---	<b>FMF1250-45</b>
1 7/8" - 12	1 1/2"	<b>1700</b>	2.300"	2.300"	2.000"	.065"	<b>SFMF1500-45</b>	<b>FMF1500-45</b>
2 1/2" - 12	2"	<b>1250</b>	3.000"	3.000"	3.000"	.065"	<b>SFMF2000-45</b>	<b>FMF2000-45</b>

### 90° Elbow Female

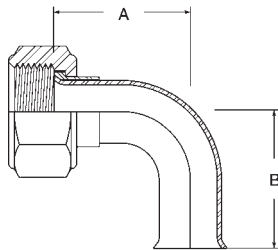

Female SAE 37° JIC	Tube OD	Pressure Rating PSI at 70°F (21°)	Dimension		Bend Radius	Tube Wall	304 Stainless Steel Nut & Sleeve Part #	Carbon Steel Nut & Sleeve Part #
			A	B				
7/16" - 20	1/4"	<b>5000</b>	1.000"	1.000"	0.375"	.049"	<b>SFMF250-90</b>	<b>FMF250-90</b>
9/16" - 18	3/8"	<b>4500</b>	1.250"	1.250"	0.500"	.049"	<b>SFMF375-90</b>	<b>FMF375-90</b>
3/4" - 16	1/2"	<b>4000</b>	1.830"	1.830"	1.000"	.049"	<b>SFMF500-90</b>	<b>FMF500-90</b>
1-1/16" - 12	3/4"	<b>2600</b>	2.350"	2.350"	1.500"	.049"	<b>SFMF750-90</b>	<b>FMF750-90</b>
1-5/16" - 12	1"	<b>2500</b>	3.100"	3.100"	2.000"	.049"	<b>SFMF1000-90</b>	<b>FMF1000-90</b>
1 5/8" - 12	1 1/4"	<b>2050</b>	3.500"	3.500"	2.000"	.065"	<b>SFMF1250-90</b>	<b>FMF1250-90</b>
1 7/8" - 12	1 1/2"	<b>1700</b>	3.750"	3.750"	2.000"	.065"	<b>SFMF1500-90</b>	<b>FMF1500-90</b>
2 1/2" - 12	2"	<b>1250</b>	4.900"	4.900"	2.000"	.065"	<b>SFMF2000-90</b>	<b>FMF2000-90</b>

## NPTF



## Male Hex Pipe Nipples

## Features:

- reference SAE 140137
- pressure rating at 70°F (21°C)

Male NPTF	Male NPTF	PSI	Zinc Plated Steel Part #
1/8"-27	1/8"-27	5000	5404-2
1/4"-18	1/4"-18	5000	5404-4
3/8"-18	3/8"-18	4000	5404-6
3/8"-18	1/4"-18	4000	5404-6-4
1/2"-14	1/2"-14	3000	5404-8
1/2"-14	3/8"-18	3000	5404-8-6
3/4"-14	3/4"-14	2500	5404-12
3/4"-14	1/2"-14	2500	5404-12-8
1"-11 1/2	1"-11 1/2	2000	5404-16
1"-11 1/2	3/4"-14	2000	5404-16-12
1 1/4"-11 1/2	1 1/4"-11 1/2	1150	5404-20

## Male x Female Hex Reducer Bushings

## Features:

- reference SAE 140140
- pressure rating at 70°F (21°C)



Male NPTF	Female NPTF	PSI	Zinc Plated Steel Part #
1/4"-18	1/8"-27	5000	5406-4-2
3/8"-18	1/8"-27	4000	5406-6-2
3/8"-18	1/4"-18	4000	5406-6-4
1/2"-14	1/8"-27	3000	5406-8-2
1/2"-14	1/4"-18	3000	5406-8-4
1/2"-14	3/8"-18	3000	5406-8-6
3/4"-14	1/8"-27	2500	5406-12-2
3/4"-14	1/4"-18	2500	5406-12-4
3/4"-14	3/8"-18	2500	5406-12-6
3/4"-14	1/2"-14	2500	5406-12-8
1"-11 1/2	1/4"-18	2000	5406-16-4
1"-11 1/2	3/8"-18	2000	5406-16-6
1"-11 1/2	1/2"-14	2000	5406-16-8
1"-11 1/2	3/4"-14	2000	5406-16-12
1 1/4"-11 1/2	3/8"-18	1150	5406-20-6
1 1/4"-11 1/2	1/2"-14	1150	5406-20-8
1 1/4"-11 1/2	3/4"-14	1150	5406-20-12
1 1/4"-11 1/2	1"-11 1/2	1150	5406-20-16
1 1/2"-11 1/2	1/2"-14	1000	5406-24-8
1 1/2"-11 1/2	3/4"-14	1000	5406-24-12
1 1/2"-11 1/2	1"-11 1/2	1000	5406-24-16
1 1/2"-11 1/2	1 1/4"-11 1/2	1000	5406-24-20
2"-11 1/2"	1/2"-14	1000	5406-32-8
2"-11 1/2"	3/4"-14	1000	5406-32-12
2"-11 1/2"	1"-11 1/2	1000	5406-32-16
2"-11 1/2"	1 1/4"-11 1/2	1000	5406-32-20
2"-11 1/2"	1 1/2"-11 1/2	1000	5406-32-24



## NPTF

**Features:**

- compact design provides ease of assembly in confining areas
- designed to prevent hose stress due to twisting during assembly
- female NPSM swivel seals on a 30° seat
- male NPTF must have a 30° chamfer to seal

**Male x Female NPSM Swivel Adapters****Features:**

- reference SAE 140130
- pressure rating at **70°F (21°C)**

Male NPTF	Female NPSM Swivel	PSI	Zinc Plated Steel Part #
1/8"-27	1/8"-27	5000	1404-2-2
1/8"-27	1/4"-18	4500	1404-2-4
1/4"-18	1/4"-18	4500	1404-4-4
1/4"-18	3/8"-18	4000	1404-4-6
3/8"-18	1/4"-18	4000	1404-6-4
3/8"-18	3/8"-18	4000	1404-6-6
3/8"-18	1/2"-14	4000	1404-6-8
1/2"-14	3/8"-18	3000	1404-8-6
1/2"-14	1/2"-14	3000	1404-8-8
1/2"-14	3/4"-14	3000	1404-8-12
3/4"-14	1/2"-14	2500	1404-12-8
3/4"-14	3/4"-14	2500	1404-12-12
1"-11 1/2	1"-11 1/2	2000	1404-16-16
1 1/4"-11 1/2	1 1/4"-11 1/2	1150	1404-20-20
1 1/2"-11 1/2	1 1/2"-11 1/2	1000	1404-24-24
2"-11 1/2	2"-11 1/2	1000	1404-32-32

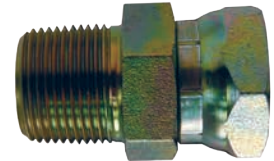
**Female Hex Pipe Couplings****Features:**

- reference SAE 140138
- pressure rating at **70°F (21°C)**

Female NPTF	Female NPTF	PSI	Zinc Plated Steel Part #
1/8"-27	1/8"-27	5000	5000-2
1/4"-18	1/4"-18	5000	5000-4
3/8"-18	1/4"-18	4000	5000-6-4
3/8"-18	3/8"-18	4000	5000-6
1/2"-14	3/8"-18	3000	5000-8-6
1/2"-14	1/2"-14	3000	5000-8
3/4"-14	3/4"-14	2500	5000-12
1"-11 1/2	3/4"-14	2000	5000-16-12
1"-11 1/2	1"-11 1/2	2000	5000-16
1 1/4"-11 1/2	1 1/4"-11 1/2	1150	5000-20

**Female x Female NPSM Swivel Nuts****Features:**

- reference SAE 140131
- pressure rating at **70°F (21°C)**

Female NPTF	Female NPSM Swivel	PSI	Zinc Plated Steel Part #
1/8"-27	1/8"-27	5000	1405-2-2
1/4"-18	1/4"-18	4500	1405-4-4
3/8"-18	1/4"-18	4000	1405-6-4
3/8"-18	3/8"-18	4000	1405-6-6
3/8"-18	1/2"-14	4000	1405-6-8
1/2"-14	1/2"-14	3000	1405-8-8
3/4"-14	1/2"-14	2500	1405-12-8
3/4"-14	3/4"-14	2500	1405-12-12
1"-11 1/2	1"-11 1/2	2000	1405-16-16
1 1/4"-11 1/2	1 1/4"-11 1/2	1150	1405-20-20
1 1/2"-11 1/2	1 1/2"-11 1/2	1000	1405-24-24
2"-11 1/2	2"-11 1/2	1000	1405-32-32

**90° Male x Male Elbows****Features:**

- reference SAE 140237
- pressure rating at **70°F (21°C)**

Male NPTF	Male NPTF	PSI	Zinc Plated Steel Part #
1/4"-18	1/4"-18	5000	5500-4
3/8"-18	3/8"-18	4000	5500-6
1/2"-14	1/2"-14	3000	5500-8
3/4"-14	3/4"-14	2500	5500-12
1"-11 1/2	1"-11 1/2	2000	5500-16



## NPTF



## 90° Male x Female Street Elbows

## Features:

- reference 140239
- pressure rating at 70°F (21°C)

Male NPTF	Female NPTF	PSI	Zinc Plated Steel Part #
1/4"-18	1/4"-18	5000	5502-4
3/8"-18	3/8"-18	4000	5502-6
1/2"-14	1/2"-14	3000	5502-8
3/4"-14	3/4"-14	2500	5502-12
1"-11½	1"-11½	2000	5502-16
1¼"-11½	1¼"-11½	1150	5502-20

## 90° Male x Female NPSM Swivel Nut Elbows

## Features:

- reference SAE 140230
- pressure rating at 70°F (21°C)



Male NPTF	Female NPSM Swivel	PSI	Zinc Plated Steel Part #
1/8"-27	1/8"-27	5000	1501-2-2
1/4"-18	1/4"-18	4500	1501-4-4
1/4"-18	3/8"-18	4000	1501-4-6
3/8"-18	1/4"-18	4000	1501-6-4
3/8"-18	3/8"-18	4000	1501-6-6
3/8"-18	1/2"-14	4000	1501-6-8
1/2"-14	3/8"-18	3000	1501-8-6
1/2"-14	1/2"-14	3000	1501-8-8
1/2"-14	3/4"-14	3000	1501-8-12
3/4"-14	1/2"-14	2500	1501-12-8
3/4"-14	3/4"-14	2500	1501-12-12
3/4"-14	1"-11½	2000	1501-12-16
1"-11½	3/4"-14	2000	1501-16-12
1"-11½	1"-11½	2000	1501-16-16
1"-11½	1¼"-11½	1150	1501-16-20
1¼"-11½	1¼"-11½	1150	1501-20-20

## 90° Female Pipe Elbows

## Features:

- reference SAE 140237
- pressure rating at 70°F (21°C)



Female NPTF	Female NPTF	PSI	Zinc Plated Steel Part #
1/8"-27	1/8"-27	5000	5504-2
1/4"-18	1/4"-18	5000	5504-4
3/8"-18	3/8"-18	4000	5504-6
1/2"-14	1/2"-14	3000	5504-8
3/4"-14	3/4"-14	2500	5504-12
1"-11½	1"-11½	2000	5504-16

## 90° Female x Female NPSM Swivel Nut Elbows

## Features:

- reference SAE 140251
- pressure rating at 70°F (21°C)



Female NPTF	Female NPSM Swivel	PSI	Zinc Plated Steel Part #
1/4"-18	1/4"-18	4500	1502-4-4
3/8"-18	3/8"-18	4000	1502-6-6
1/2"-14	1/2"-14	3000	1502-8-8
3/4"-14	3/4"-14	2500	1502-12-12
1"-11½	1"-11½	2000	1502-16-16

## 45° Male x Female NPSM Swivel Nut Elbows

## Features:

- reference SAE 140330
- pressure rating at 70°F (21°C)



Male NPTF	Female NPSM Swivel	PSI	Zinc Plated Steel Part #
1/4"-18	1/4"-18	4500	1503-4-4
3/8"-18	3/8"-18	4000	1503-6-6
1/2"-14	1/2"-14	3000	1503-8-8
3/4"-14	3/4"-14	2500	1503-12-12
1"-11½	1"-11½	2000	1503-16-16

NPTF  
Male Pipe Tees

Features:

- reference SAE 140437
- pressure rating at **70°F (21°C)**

Male NPTF (3)	PSI	Zinc Plated Steel Part #
¼"-18	5000	5600-4
⅜"-18	4000	5600-6
½"-14	3000	5600-8
¾"-14	2500	5600-12
1"-11½	2000	5600-16



Male x Female Pipe Tees

Features:

- reference SAE 140427
- pressure rating at **70°F (21°C)**

Male NPTF (2)	Female NPTF	PSI	Zinc Plated Steel Part #
¼"-18	¼"-18	5000	5601-4
⅜"-18	⅜"-18	4000	5601-6
½"-14	½"-14	3000	5601-8
¾"-14	¾"-14	2500	5601-12
1"-11½	1"-11½	2000	5601-16



Female x Male Branch Tees

Features:

- reference SAE 140425
- pressure rating at **70°F (21°C)**

Female NPTF (2)	Male NPTF	PSI	Zinc Plated Steel Part #
¼"-18	¼"-18	5000	5604-4
⅜"-18	⅜"-18	4000	5604-6
½"-14	½"-14	3000	5604-8
¾"-14	¾"-14	2500	5604-12
1"-11½	1"-11½	2000	5604-16



Female Pipe Tees

Features:

- reference 140438
- pressure rating at **70°F (21°C)**

Female NPTF (3)	PSI	Zinc Plated Steel Part #
¼"-18	5000	5605-4
⅜"-18	4000	5605-6
½"-14	3000	5605-8
¾"-14	2500	5605-12
1"-11½	2000	5605-16



Male x Female Run Tees

Features:

- reference 140424
- pressure rating at **70°F (21°C)**

Male NPTF	Female NPTF (2)	PSI	Zinc Plated Steel Part #
⅛"-27	⅛"-27	5000	5602-2
¼"-18	¼"-18	5000	5602-4
⅜"-18	⅜"-18	4000	5602-6
½"-14	½"-14	3000	5602-8
¾"-14	¾"-14	2500	5602-12
1"-11½	1"-11½	2000	5602-16
1-¼"-11½	1-¼"-11½	1150	5602-20
1-½"-11½	1-½"-11½	1000	5602-24



## NPTF

## Female Hex Caps

## Feature:

- pressure rating at 70°F (21°C)



Female NPTF	PSI	Zinc Plated Steel Part #
1/8"-27	5000	5406C-2
1/4"-18	5000	5406C-4
3/8"-18	4000	5406C-6
1/2"-14	3000	5406C-8
3/4"-14	2500	5406C-12
1"-11½	2000	5406C-16
1¼"-11½	1150	5406C-20
1½"-11½	1000	5406C-24

## Male Hex Plugs

## Features:

- reference SAE 130109C
- pressure rating at 70°F (21°C)



Male NPTF	PSI	Zinc Plated Steel Part #
1/8"-27	5000	1251-02H
1/4"-18	5000	1251-04H
3/8"-18	4000	1251-06H
1/2"-14	3000	1251-08H
3/4"-14	2500	1251-12H
1"-11½	2000	1251-16H
1¼"-11½	1150	1251-20H

## Male JIC 37° Flare x Male Metric Parallel Thread

## Feature:

- pressure rating at 70°F (21°C)



Male JIC 37° Flare	Male Metric Parallel	Zinc Plated Steel Part #
7/16"-20	M10X1.0	M7400-4-10
7/16"-20	M12X1.5	M7400-4-12
9/16"-18	M14X1.5	M7400-6-14
9/16"-18	M16X1.5	M7400-6-16
¾"-16	M16X1.5	M7400-8-16
¾"-16	M18X1.5	M7400-8-18
1-1/16"-12	M22X1.5	M7400-12-22
1-1/16"-12	M27X2.0	M7400-12-27
1-5/16"-12	M33X2.0	M7400-16-33

## Female Pipe x Male Metric Parallel Thread

## Feature:

- pressure rating at 70°F (21°C)



Female NPTF	Male Metric Parallel	Zinc Plated Steel Part #
1/4"-18	M12X1.5	M7455-4-12
1/4"-18	M14X1.5	M7455-4-14
3/8"-18	M16X1.5	M7455-6-16
3/8"-18	M18X1.5	M7455-6-18
1/2"-14	M16X1.5	M7455-8-16
1/2"-14	M18X1.5	M7455-8-18
1/2"-14	M22X1.5	M7455-8-22
3/4"-14	M27X2.0	M7455-12-27
1"-11½	M33X2.0	M7455-16-33

## British Standard Pipe Parallel (BSPP)

## Male JIC 37° Flare x Male

## Feature:

- pressure rating at 70°F (21°C)

Male JIC 37° Flare	Male BSPP	PSI	Zinc Plated Steel Part #
7/16"-20	¼"-19	5000	<b>B3800-4-4</b>
9/16"-18	⅜"-19	4000	<b>B3800-6-6</b>
¾"-16	½"-14	3000	<b>B3800-8-8</b>
1-1/16"-12	¾"-14	2500	<b>B3800-12-12</b>
1-5/16"-12	1"-11	2000	<b>B3800-16-16</b>



## Male NPTF x Male

## Feature:

- pressure rating at 70°F (21°C)

Male NPTF	Male BSPP	PSI	Zinc Plated Steel Part #
¼"-18	¼"-19	5000	<b>B3401-4-4</b>
⅜"-18	⅜"-19	4000	<b>B3401-6-6</b>
½"-14	½"-14	3000	<b>B3401-8-8</b>
¾"-14	¾"-14	2500	<b>B3401-12-12</b>
1"-11½	1"-11	2000	<b>B3401-16-16</b>



## Female NPTF x Male

## Feature:

- pressure rating at 70°F (21°C)

Female NPTF	Male BSPP	PSI	Zinc Plated Steel Part #
¼"-18	¼"-19	5000	<b>B3455-4-4</b>
⅜"-18	⅜"-19	4000	<b>B3455-6-6</b>
½"-14	½"-14	3000	<b>B3455-8-8</b>
¾"-14	¾"-14	2500	<b>B3455-12-12</b>
1"-11½	1"-11	2000	<b>B3455-16-16</b>



## Male JIC 37° Flare x Male 90° Elbow

## Feature:

- pressure rating at 70°F (21°C)

Male JIC 37° Flare	Male BSPP	PSI	Zinc Plated Steel Part #
7/16"-20	¼"-19	5000	<b>B3801-4-4</b>
9/16"-18	⅜"-19	4000	<b>B3801-6-6</b>
¾"-16	½"-14	3000	<b>B3801-8-8</b>
1-1/16"-12	¾"-14	2500	<b>B3801-12-12</b>
1-5/16"-12	1"-11	2000	<b>B3801-16-16</b>



## Bonded Dowty Seal for British Thread

## Feature:

- pressure rating at 70°F (21°C)

Size	Plated Carbon Steel with Buna O-ring Part #
¼"-19	<b>BDS04</b>
⅜"-19	<b>BDS06</b>
½"-14	<b>BDS08</b>
¾"-14	<b>BDS12</b>
1"-11	<b>BDS16</b>



## Hydraulic 4-Bolt Flanges

**Features:**

- flat face flange must be used with O-ring flange
- code 61 - standard pressure; code 62 - high pressure
- makes installation of components easier, especially in applications with limited space
- bolt kit with Buna O-ring included with O-ring flange
- no bolt kit is included with flat face flange
- also available in 316L stainless, contact Dixon® for more information

### Hydraulic 4-Bolt Flange NPTF Port



Port Size	Pad Size	NPTF Thread	Code 61 Carbon Steel			
			O-ring		Flat Face	
			Previous Part #	Part #	Previous Part #	Part #
1/2"	1/2"	1/2"-14	W43-8-8-U	<b>C6143K0808NPT</b>	W104-8-8	<b>C611040808NPT</b>
3/4"	3/4"	3/4"-14	W43-12-12-U	<b>C6143K1212NPT</b>	W104-12-12	<b>C611041212NPT</b>
1"	1"	1"-11 1/2	W43-16-16-U	<b>C6143K1616NPT</b>	W104-16-16	<b>C611041616NPT</b>
1 1/4"	1 1/4"	1 1/4"-11 1/2	W43-20-20-U	<b>C6143K2020NPT</b>	W104-20-20	<b>C611042020NPT</b>
1 1/2"	1 1/2"	1 1/2"-11 1/2	W43-24-24-U	<b>C6143K2424NPT</b>	W104-24-24	<b>C611042424NPT</b>
2"	2"	2"-11 1/2	W43-32-32-U	<b>C6143K3232NPT</b>	W104-32-32	<b>C611043232NPT</b>
2 1/2"	2 1/2"	2 1/2"-8	W43-40-40-U	<b>C6143K4040NPT</b>	W104-40-40	<b>C611044040NPT</b>
3"	3"	3"-8	W43-48-48-U	<b>C6143K4848NPT</b>	W104-48-48	<b>C611044848NPT</b>

Port Size	Pad Size	NPTF Thread	Code 62 Carbon Steel			
			O-ring		Flat Face	
			Previous Part #	Part #	Previous Part #	Part #
1/2"	1/2"	1/2"-14	W44-8-8-U	<b>C6244K0808NPT</b>	W45-8-8	<b>C62450808NPT</b>
3/4"	3/4"	3/4"-14	W44-12-12-U	<b>C6244K1212NPT</b>	W45-12-12	<b>C62451212NPT</b>
1"	1"	1"-11 1/2	W44-16-16-U	<b>C6244K1616NPT</b>	W45-16-16	<b>C62451616NPT</b>
1 1/4"	1 1/4"	1 1/4"-11 1/2	W44-20-20-U	<b>C6244K2020NPT</b>	W45-20-20	<b>C62452020NPT</b>
1 1/2"	1 1/2"	1 1/2"-11 1/2	W44-24-24-U	<b>C6244K2424NPT</b>	W45-24-24	<b>C62452424NPT</b>
2"	2"	2"-11 1/2	W44-32-32-U	<b>C6244K3232NPT</b>	W45-32-32	<b>C62453232NPT</b>

### Hydraulic 4-Bolt Flange SAE Port



Port Size	Pad Size	UN/UNF-2B Thread	Code 61 Carbon Steel			
			O-ring		Flat Face	
			Previous Part #	Part #	Previous Part #	Part #
1/2"	1/2"	3/4"-16	W46-8-8-U	<b>C6146K0808SAE</b>	W106-8-8	<b>C611060808SAE</b>
3/4"	3/4"	1 1/16"-12	W46-12-12-U	<b>C6146K1212SAE</b>	W106-12-12	<b>C611061212SAE</b>
1"	1"	1 5/16"-12	W46-16-16-U	<b>C6146K1616SAE</b>	W106-16-16	<b>C611061616SAE</b>
1 1/4"	1 1/4"	1 5/8"-12	W46-20-20-U	<b>C6146K2020SAE</b>	W106-20-20	<b>C611062020SAE</b>
1 1/2"	1 1/2"	1 7/8"-12	W46-24-24-U	<b>C6146K2424SAE</b>	W106-24-24	<b>C611062424SAE</b>
2"	2"	2 1/2"-12	W46-32-32-U	<b>C6146K3232SAE</b> <sup>1</sup>	W106-32-32	<b>C611063232SAE</b>

<sup>1</sup> 1000 PSI maximum

Port Size	Pad Size	UN/UNF-2B Thread	Code 62 Carbon Steel			
			O-ring		Flat Face	
			Previous Part #	Part #	Previous Part #	Part #
1/2"	1/2"	3/4"-16	W48-8-8-U	<b>C6248K0808SAE</b>	W49-8-8	<b>C62490808SAE</b>
3/4"	3/4"	1 1/16"-12	W48-12-12-U	<b>C6248K1212SAE</b>	W49-12-12	<b>C62491212SAE</b>
1"	1"	1 5/16"-12	W48-16-16-U	<b>C6248K1616SAE</b>	W49-16-16	<b>C62491616SAE</b>
1 1/4"	1 1/4"	1 5/8"-12	W48-20-20-U	<b>C6248K2020SAE</b>	W49-20-20	<b>C62492020SAE</b>
1 1/2"	1 1/2"	1 7/8"-12	W48-24-24-U	<b>C6248K2424SAE</b>	W49-24-24	<b>C62492424SAE</b>
2"	2"	2 1/2"-12	W48-32-32-U	<b>C6248K3232SAE</b>	W49-32-32	<b>C62493232SAE</b>

 • For flange dimensions, diagrams and additional information please reference [dixonvalve.com](http://dixonvalve.com).

## Hydraulic 4-Bolt Flanges

## Hydraulic 4-Bolt Flange Pipe Socket Weld

Port Size	Pad Size	Code 61 Carbon Steel			
		O-ring		Flat Face	
		Previous Part #	Part #	Previous Part #	Part #
1/2"	1/2"	W4-8-8-U	<b>C614K0808PSW</b>	W61-8-8	<b>C61610808PSW</b>
3/4"	3/4"	W4-12-12-U	<b>C614K1212PSW</b>	W61-12-12	<b>C61611212PSW</b>
1"	1"	W4-16-16-U	<b>C614K1616PSW</b>	W61-16-16	<b>C61611616PSW</b>
1 1/4"	1 1/4"	W4-20-20-U	<b>C614K2020PSW</b>	W61-20-20	<b>C61612020PSW</b>
1 1/2"	1 1/2"	W4-24-24-U	<b>C614K2424PSW</b>	W61-24-24	<b>C61612424PSW</b>
2"	2"	W4-32-32-U	<b>C614K3232PSW</b>	W61-32-32	<b>C61613232PSW</b>
2 1/2"	2 1/2"	W4-40-40-U	<b>C614K4040PSW</b>	W61-40-40	<b>C61614040PSW</b>
3"	3"	W4-48-48-U	<b>C614K4848PSW</b>	W61-48-48	<b>C61614848PSW</b>

Port Size	Pad Size	Code 62 Carbon Steel			
		O-ring		Flat Face	
		Previous Part #	Part #	Previous Part #	Part #
1/2"	1/2"	W59-8-8-U	<b>C6259K0808PSW</b>	W60-8-8	<b>C62600808PSW</b>
3/4"	3/4"	W59-12-12-U	<b>C6259K1212PSW</b>	W60-12-12	<b>C62601212PSW</b>
1"	1"	W59-16-16-U	<b>C6259K1616PSW</b>	W60-16-16	<b>C62601616PSW</b>
1 1/4"	1 1/4"	W59-20-20-U	<b>C6259K2020PSW</b>	W60-20-20	<b>C62602020PSW</b>
1 1/2"	1 1/2"	W59-24-24-U	<b>C6259K2424PSW</b>	W60-24-24	<b>C62602424PSW</b>
2"	2"	W59-32-32-U	<b>C6259K3232PSW</b>	W60-32-32	<b>C62603232PSW</b>
2 1/2"	2 1/2"	W59-40-40-U	<b>C6259K4040PSW</b>	W60-40-40	<b>C62604040PSW</b>
3"	3"	W59-48-48-U	<b>C6259K4848PSW</b>	W60-48-48	<b>C62604848PSW</b>



## Pressure Ratings of SAE Flanges

## Code 61 SAE J518-1 / ISO 6162-1

Dash Size	Size	Maximum Working Pressure		Fastener Torque Value
		PSI	MPa	Grade 8 UNC (lb-ft)
-8	1/2"	5000	35	24
-12	3/4"	5000	35	44
-16	1"	4600	32	44
-20	1 1/4"	4000	28	68
-24	1 1/2"	3000	21	111
-32	2"	3000	21	111
-40	2 1/2"	2500	17.5	111
-48	3"	2300	16	218
-56	3 1/2"	500	3.5	218
-64	4"	500	3.5	218
-80	5"	500	3.5	218

- Connection type opposite 4-bolt flange connection can de-rate maximum working pressure.

## Code 62 SAE J518-2 / ISO 6162-2

Dash Size	Size	Maximum Working Pressure		Fastener Torque Value
		PSI	MPa	Grade 8 UNC (lb-ft)
-8	1/2"	6000	40	24
-12	3/4"	6000	40	44
-16	1"	6000	40	68
-20	1 1/4"	6000	40	111
-24	1 1/2"	6000	40	218
-32	2"	6000	40	332
-40	2 1/2"	6000	40	380
-48	3"	6000	40	667

- For flange dimensions, diagrams and additional information please reference [dixonvalve.com](http://dixonvalve.com).



### Code 61 / Code 62 Split Flange Kits

**Features:**

- for tube, hose end and split flange adapter connections
- kits include 2 split flange halves, 4 hex head screws and lockwashers, 1 Buna O-ring
- silver trivalent finish for high corrosion resistance
- also available in forged 316L stainless, contact Dixon® for more information

Flange Size	Code 61 Forged Carbon Steel		Code 62 Forged Carbon Steel	
	Previous Part #	Part #	Previous Part #	Part #
1/2"	8SFO	<b>C6108-SFKIT</b>	8SF XO	<b>C6208-SFKIT</b>
3/4"	12SFO	<b>C6112-SFKIT</b>	12SF XO	<b>C6212-SFKIT</b>
1"	16SFO	<b>C6116-SFKIT</b>	16SF XO	<b>C6216-SFKIT</b>
1 1/4"	20SFO	<b>C6120-SFKIT</b>	20SF XO	<b>C6220-SFKIT</b>
1 1/2"	24SFO	<b>C6124-SFKIT</b>	24SF XO	<b>C6224-SFKIT</b>
2"	32SFO	<b>C6132-SFKIT</b>	32SF XO	<b>C6232-SFKIT</b>
2 1/2"	40SFO	<b>C6140-SFKIT</b>	---	---
3"	48SFO	<b>C6148-SFKIT</b>	---	---

### Code 61 / Code 62 Flange Adapters

#### Straight Flange x Male JIC Hydraulic Adapter



JIC Thread	Tube OD	Flange Size	Code 61 Carbon Steel		Code 62 Carbon Steel	
			Previous Part #	Part #	Previous Part #	Part #
3/4"-16	1/2"	1/2"	300-8-8	<b>C6100F0808</b>	---	---
3/4"-16	1/2"	3/4"	300-8-12	<b>C6100F0812</b>	---	---
1 1/16"-12	3/4"	3/4"	300-12-12	<b>C6100F1212</b>	600-12-12	<b>C6200F1212</b>
1 1/16"-12	3/4"	1"	300-12-16	<b>C6100F1216</b>	600-12-16	<b>C6200F1216</b>
1 5/16"-12	1"	3/4"	300-16-12	<b>C6100F1612</b>	600-16-12	<b>C6200F1612</b>
1 5/16"-12	1"	1"	300-16-16	<b>C6100F1616</b>	600-16-16	<b>C6200F1616</b>
1 5/16"-12	1"	1 1/4"	300-16-20	<b>C6100F1620</b>	600-16-20	<b>C6200F1620</b>
1 5/8"-12	1 1/4"	1"	300-20-16	<b>C6100F2016</b>	600-20-16	<b>C6200F2016</b>
1 5/8"-12	1 1/4"	1 1/4"	300-20-20	<b>C6100F2020</b>	600-20-20	<b>C6200F2020</b>
1 5/8"-12	1 1/4"	1 1/2"	300-20-24	<b>C6100F2024</b>	600-20-24	<b>C6200F2024</b>
1 7/8"-12	1 1/2"	1 1/2"	300-24-20	<b>C6100F2420</b>	600-24-20	<b>C6200F2420</b>
1 7/8"-12	1 1/2"	1 1/2"	300-24-24	<b>C6100F2424</b>	600-24-24	<b>C6200F2424</b>
1 7/8"-12	1 1/2"	2"	300-24-32	<b>C6100F2432</b>	600-24-32	<b>C6200F2432</b>
2 1/2"-12	2"	1 1/2"	300-32-24	<b>C6100F3224</b>	600-32-24	<b>C6200F3224</b>
2 1/2"-12	2"	2"	300-32-32	<b>C6100F3232</b>	600-32-32	<b>C6200F3232</b>

#### 90° Flange Elbow x Male JIC Hydraulic Adapter



JIC Thread	Tube OD	Flange Size	Code 61 Carbon Steel		Code 62 Carbon Steel	
			Previous Part #	Part #	Previous Part #	Part #
3/4"-16	1/2"	3/4"	390-8-12	<b>C6190F0812</b>	---	---
1 1/16"-12	3/4"	3/4"	390-12-12	<b>C6190F1212</b>	690-12-12	<b>C6290F1212</b>
1 1/16"-12	3/4"	1"	390-12-16	<b>C6190F1216</b>	690-12-16	<b>C6290F1216</b>
1 5/16"-12	1"	3/4"	390-16-12	<b>C6190F1612</b>	690-16-12	<b>C6290F1612</b>
1 5/16"-12	1"	1"	390-16-16	<b>C6190F1616</b>	690-16-16	<b>C6290F1616</b>
1 5/16"-12	1"	1 1/4"	390-16-20	<b>C6190F1620</b>	690-16-20	<b>C6290F1620</b>
1 5/8"-12	1 1/4"	1"	390-20-16	<b>C6190F2016</b>	690-20-16	<b>C6290F2016</b>
1 5/8"-12	1 1/4"	1 1/4"	390-20-20	<b>C6190F2020</b>	690-20-20	<b>C6290F2020</b>
1 5/8"-12	1 1/4"	1 1/2"	390-20-24	<b>C6190F2024</b>	690-20-24	<b>C6290F2024</b>
1 7/8"-12	1 1/2"	1 1/2"	390-24-24	<b>C6190F2424</b>	690-24-24	<b>C6290F2424</b>
1 7/8"-12	1 1/2"	2"	390-24-32	<b>C6190F2432</b>	690-24-32	<b>C6290F2432</b>
2 1/2"-12	2"	1 1/2"	390-32-24	<b>C6190F3224</b>	690-32-24	<b>C6290F3224</b>
2 1/2"-12	2"	2"	390-32-32	<b>C6190F3232</b>	690-32-32	<b>C6290F3232</b>

#### 45° Flange Elbow x Male JIC Hydraulic Adapter



JIC Thread	Tube OD	Flange Size	Code 61 Carbon Steel		Code 62 Carbon Steel	
			Previous Part #	Part #	Previous Part #	Part #
1 1/16"-12	3/4"	3/4"	340-12-12	<b>C6145F1212</b>	640-12-12	<b>C6245F1212</b>
1 5/16"-12	1"	1"	340-16-16	<b>C6145F1616</b>	640-16-16	<b>C6245F1616</b>
1 5/8"-12	1 1/4"	1 1/4"	340-20-20	<b>C6145F2020</b>	640-20-20	<b>C6245F2020</b>
1 7/8"-12	1 1/2"	1 1/2"	340-24-24	<b>C6145F2424</b>	640-24-24	<b>C6245F2424</b>
2 1/2"-12	2"	2"	340-32-32	<b>C6145F3232</b>	640-32-32	<b>C6245F3232</b>



Hydraulic Suction and Return Line Hose Couplings

**Application:**

- designed for hydraulic suction line applications using SAE100R4 hydraulic hose

**Feature:**

- barbs provide easy assembly and maximum gripping action

**Female SAE Stem**

Hose ID	Male NPTF	Plated Steel Part #
3/4"	3/4"-14	<b>188-12</b>
1"	1"-11½	<b>188-16</b>
1¼"	1¼"-11½	<b>188-20</b>
1½"	1½"-11½	<b>188-24</b>
2"	2"-11½	<b>188-32</b>

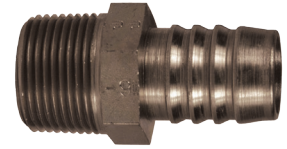

Hydraulic Fittings

**Female SAE 37° Swivel Stem**

Hose ID	Male NPTF	Plated Steel Part #
3/4"	1-1/16"-12	<b>688-12</b>
1"	1-5/16"-12	<b>688-16</b>
1¼"	1⅝"-12	<b>688-20</b>
1½"	1⅞"-12	<b>688-24</b>
2"	2½"-12	<b>688-32</b>

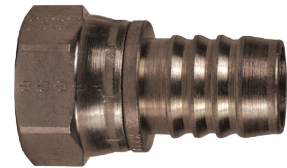

- return line clamps must be used with these fittings

Double Bolt Clamps

**Features:**

- inner surface has dual gripping ridges
- bolt lugs are reinforced to prevent bending out of alignment
- Torque values for clamps are based on dry bolts.
- The use of lubricant on bolts will adversely effect clamp performance.
- measure hose OD accurately before ordering clamps
- Consult Dixon® when using double bolt clamps on helical wire hose.



Hose OD		Plated Iron Part #	Torque in ft. lbs.	Optional Qty
from	to			
1-8/64"	1-12/64"	<b>J48</b>	15	100
1-40/64"	1-52/64"	<b>DL14</b>	40	25
1-48/64"	2-3/64"	<b>DL20</b>	27	25
2-7/64"	2-19/64"	<b>DL24<sup>1</sup></b>	27	25
2-20/64"	2-40/64"	<b>DL32<sup>1</sup></b>	40	25



<sup>1</sup> investment cast carbon steel

Hydraulic Hose Stems

Hydraulic Fittings



Features:

- stems have a collar behind the hex to engage clamp fingers
- reference clamps on page 75

NPTF Size	Plated Steel Part #
1/2"	<b>HY4</b>
1"	<b>HY8</b>

NPTF Size	Plated Steel Part #
1 1/4"	<b>HY10</b>
1 1/2"	<b>HY12</b>
2"	<b>HY16</b>

Hydraulic Hose Clamps For 1 Wire Hose



Feature:

- for use only on 1 wire hydraulic hoses

Hose ID	Hose OD		Plated Iron Part #	Torque in ft. lbs.
	from	to		
3/8"	48/64"	50/64"	<b>HD1-3</b>	12
1/2"	56/64"	60/64"	<b>HD1-4</b>	18
3/4"	1-10/64"	1-14/64"	<b>HD1-6</b>	18
1"	1-29/64"	1-35/64"	<b>HD1-8</b>	36

Hydraulic Hose Clamps For 1 or 2 Wire Hose

Features:

- for use only on 1 or 2 wire hydraulic hoses
- This clamp *should not* be used on 4 or 6 wire hydraulic hose even when hose falls within recommended ranges. 



Hose ID	Hose OD		Plated Iron Part #	Torque in ft. lbs.
	from	to		
3/8"	50/64"	52/64"	<b>HRC-037</b>	18
1/2"	57/64"	1"	<b>HRC-050</b>	18
3/4"	1-16/64"	1-20/64"	<b>HRC-075</b>	36
1"	1-37/64"	1-41/64"	<b>HRC-100</b>	64
1 1/4"	1-54/64"	1-62/64"	<b>HRC-125</b>	90
1 1/2"	2-10/64"	2-18/64"	<b>HRC-150</b>	90
2"	2-43/64"	2-52/64"	<b>HRC-200</b>	90

Inline Hydraulic Filters

Features:

- provides protection for small, high pressure systems
- installs at the pressure side of a pump
- conically shaped bronze element positioned by a retaining spring to allow true, uninterrupted flow
- standard 25 micron bronze element can be easily cleaned or replaced
- temperature range: **35°F to 200°F (2°C to 93°C)**
- maximum operating pressure: **3000 PSI**



Female SAE	Overall Length	Diameter	Plated Steel Part #
9/16" - 18	3 1/4"	1 1/2"	<b>9152</b>
3/4" - 16	3 1/4"	1 1/2"	<b>9153</b>

## Pipe and Tube Clamps

**Applications:**

- standard hydraulic applications, general pipe construction, electric cables, etc.
- *Standard and twin series clamps* are recommended for systems with less than 1500 PSI without dynamic loads.
- *Heavy duty clamps* are recommended for systems with greater than 1500 PSI operating pressure.

**Features:**

- clamps are welded in place to secure the pipe or tubing
- polypropylene cushions reduce wear due to vibration
- kit includes clamp with weld plate, cover plate and bolts

**Standard Series**

Pipe Nom. Bore/Tube OD	Length	Width	Height	Steel & Polypropylene Part #
1/8" pipe	1.65"	1.18"	1.30"	<b>HST02P</b>
1/4" pipe	1.89"	1.18"	1.54"	<b>HST04P</b>
1/4" tube	1.65"	1.18"	1.30"	<b>HST04T</b>
5/16" tube	1.65"	1.18"	1.30"	<b>HST05T</b>
3/8" pipe	1.89"	1.18"	1.54"	<b>HST06P</b>
3/8" tube	1.65"	1.18"	1.30"	<b>HST06T</b>
1/2" pipe	2.17"	1.18"	1.61"	<b>HST08P</b>
1/2" tube	1.89"	1.18"	1.54"	<b>HST08T</b>
5/8" tube	1.89"	1.18"	1.54"	<b>HST10T</b>
3/4" pipe	2.44"	1.18"	1.89"	<b>HST12P</b>
3/4" tube	2.17"	1.18"	1.61"	<b>HST12T</b>
7/8" tube	2.17"	1.18"	1.61"	<b>HST14T</b>
1" pipe	2.91"	1.18"	2.52"	<b>HST16P</b>
1" tube	2.17"	1.18"	1.61"	<b>HST16T</b>
1 1/4" pipe	2.91"	1.18"	2.52"	<b>HST20P</b>
1 1/4" tube	2.91"	1.18"	2.52"	<b>HST20T</b>
1 1/2" pipe	3.46"	1.18"	2.83"	<b>HST24P</b>
1 1/2" tube	2.91"	1.18"	2.52"	<b>HST24T</b>
2" tube	3.46"	1.18"	2.83"	<b>HST32T</b>

**Twin Series**

Pipe Nom. Bore/Tube OD	Length	Width	Height	Steel & Polypropylene Part #
1/8" pipe	1.46"	1.18"	1.36"	<b>HTW02P</b>
1/4" pipe	1.46"	1.18"	1.36"	<b>HTW04P</b>
1/4" tube	1.46"	1.18"	1.36"	<b>HTW04T</b>
5/16" tube	1.46"	1.18"	1.36"	<b>HTW05T</b>
3/8" pipe	2.17"	1.18"	1.42"	<b>HTW06P</b>
3/8" tube	1.46"	1.18"	1.36"	<b>HTW06T</b>
1/2" pipe	2.76"	1.18"	1.85"	<b>HTW08P</b>
1/2" tube	2.17"	1.18"	1.42"	<b>HTW08T</b>
5/8" tube	2.17"	1.18"	1.42"	<b>HTW10T</b>
3/4" pipe	3.35"	1.18"	2.05"	<b>HTW12P</b>
3/4" tube	2.76"	1.18"	1.85"	<b>HTW12T</b>
7/8" tube	2.76"	1.18"	1.85"	<b>HTW14T</b>
1" pipe	4.33"	1.18"	2.52"	<b>HTW16P</b>
1" tube	2.76"	1.18"	1.85"	<b>HTW16T</b>
1 1/4" pipe	4.33"	1.18"	2.52"	<b>HTW20P</b>
1 1/4" tube	4.33"	1.18"	2.52"	<b>HTW20T</b>
1 1/2" tube	4.33"	1.18"	2.52"	<b>HTW24T</b>



## Pipe and Tube Clamps

## Heavy Duty Series

Hydraulic Fittings



Pipe Nom. Bore/Tube OD	Length	Width	Height	Steel & Polypropylene Part #
1/8" pipe	2.87"	1.18"	1.89"	<b>HHD02P</b>
1/4" pipe	2.87"	1.18"	1.89"	<b>HHD04P</b>
1/4" tube	2.87"	1.18"	1.89"	<b>HHD04T</b>
5/16" tube	2.87"	1.18"	1.89"	<b>HHD05T</b>
3/8" pipe	2.87"	1.18"	1.89"	<b>HHD06P</b>
3/8" tube	2.87"	1.18"	1.89"	<b>HHD06T</b>
1/2" pipe	3.35"	1.18"	2.52"	<b>HHD08P</b>
1/2" tube	2.87"	1.18"	1.89"	<b>HHD08T</b>
5/8" tube	2.87"	1.18"	1.89"	<b>HHD10T</b>
3/4" pipe	3.35"	1.18"	2.52"	<b>HHD12P</b>
3/4" tube	3.35"	1.18"	2.52"	<b>HHD12T</b>
7/8" tube	3.35"	1.18"	2.52"	<b>HHD14T</b>
1" pipe	3.94"	1.18"	2.99"	<b>HHD16P</b>
1" tube	3.35"	1.18"	2.52"	<b>HHD16T</b>
1 1/4" pipe	5.51"	1.77"	4.33"	<b>HHD20P</b>
1 1/4" tube	3.94"	1.18"	2.99"	<b>HHD20T</b>
1 1/2" pipe	5.51"	1.77"	4.33"	<b>HHD24P</b>
1 1/2" tube	3.94"	1.18"	2.99"	<b>HHD24T</b>
2" pipe	5.51"	1.77"	4.33"	<b>HHD32P</b>
2" tube	5.51"	1.77"	4.33"	<b>HHD32T</b>

<b>Ball</b> .....	532 to 546	<b>Needle</b> .....	552 to 553, 555
Bronze .....	532 to 534, 537	Mini .....	552
Domestic .....	532	Multiport .....	552
Full port .....	532	Block and bleed .....	553
Locking handle .....	533	Female x female .....	555
250 lb. steam .....	534		
Safety vented .....	534	<b>Button &amp; Tank Filler</b> .....	554
With NPT tap for drain .....	534		
Dual Y .....	537	<b>External Drains</b> .....	554
3-way diverting L flow .....	538		
Brass .....	533, 535 to 538	<b>Check</b> .....	556 to 560
Deadman spring return .....	533	Safety .....	556
Imported .....	535	Safety pop-off .....	557
With locking handle .....	535	Series C .....	558
Global .....	536	Ball cone .....	558
Solder end .....	536	800 PSI .....	559
Lead free brass .....	536	Forged steel .....	559
Mini's .....	537	Spring loaded .....	559 to 560
3-way diverting T flow .....	538	Swing .....	560
Stainless .....	538 to 542		
3-way diverting L flow .....	538	<b>Drum Valves</b> .....	561 to 562
2-piece .....	539	Wrenches .....	561
Full port .....	539	Faucets .....	561
With locking handle .....	540	Thread adapters .....	562
Reduced port .....	540	Gate valves .....	562
3-piece industrial .....	541		
Deadman spring return .....	541		
Industrial wafer .....	542		
Mann Tek full flow .....	542, 543		
Carbon steel .....	544, 545		
High pressure, full bore .....	544		
150# flanged .....	545		
Polypropylene .....	545, 546		
<b>Gate</b> .....	547		
<b>Globe</b> .....	548		
<b>Butterfly</b> .....	548 to 549		
Betts Wet-R-Dri™ .....	548		
Ductile iron .....	549		
<b>Control</b> .....	550 to 551		
Series F .....	550		
Series MV .....	550		
Series PF .....	551		
Series N .....	551		

- Sanitary valves are located on pages: 631 - 652
- Fire valves are located on pages: 821 - 842

### Domestic Bronze Ball Valves

**Application:**

- for control of air, water, oil and gas in hose or pipe lines, for other services, please contact Dixon®

**Features:**

- pressure rating: **600 PSI** WOG; **150 PSI** saturated steam
- bronze valve bodies, balls and stems
- blow-out proof stems
- glass-filled reinforced PTFE seats and stuffing box ring; stem seals and washers
- plated steel handles and nuts with vinyl sleeves replacements available, contact Dixon® for pricing
- full and standard port valves are repairable
- meets WW-V 35C, Type II Composition



Female NPT	Port	Bronze Part #
1/4"	full	<b>BBV25</b>
3/8"	full	<b>BBV38</b>
1/2"	full	<b>BBV50</b>
3/4"	standard	<b>BBV75</b>
1"	standard	<b>BBV100</b>
1 1/4"	standard	<b>BBV125</b>
1 1/2"	standard	<b>BBV150</b>
2"	standard	<b>BBV200</b>
2 1/2"	standard	<b>BBV250</b>
3"	standard	<b>BBV300</b>

### Domestic Full Port Bronze Ball Valves

**Features:**

- machined solid chrome-plated ball
- multi-fill RPTFE seats and seals
- adjustable packing
- blow-out proof stem design
- bronze castings
- vacuum service to 29 inches Hg
- pressure rating: **600 PSI** WOG; **150 PSI** saturated steam



Female NPT	Port	Bronze Part #
3/4"	full	<b>BBV75FP</b>
1"	full	<b>BBV100FP</b>
1 1/4"	full	<b>BBV125FP</b>
1 1/2"	full	<b>BBV150FP</b>
2"	full	<b>BBV200FP</b>

## Locking Handle Bronze Ball Valves

**Application:**

- for control of air, water, oil and gas in hose or pipe lines, for other services, please contact Dixon®

**Features:**

- pressure rating: **600 PSI WOG**; **150 PSI** saturated steam
- blow-out proof RPTFE stem
- chrome-plated bronze ball
- Stainless steel sliding lock mechanism secures handle in open or closed position; can be padlocked opened or closed.
- plated steel handles and nuts with vinyl sleeves
- full and standard port valves are repairable

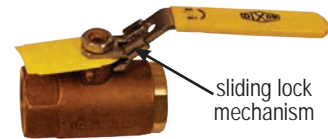

Valves

Female NPT	Port	Bronze Part #
1/4"	full	<b>BBLV25</b>
3/8"	full	<b>BBLV38</b>
1/2"	full	<b>BBLV50</b>
3/4"	standard	<b>BBLV75</b>
1"	standard	<b>BBLV100</b>
1 1/4"	standard	<b>BBLV125</b>
1 1/2"	standard	<b>BBLV150</b>
2"	standard	<b>BBLV200</b>

## Bronze Ball Valves

**Applications:**

- for air, water, oil and gas service

**Features:**

- pressure rating: **600 PSI**, cold non-shock pressure rating: **150 PSI** saturated steam
- chromium plated ball
- RTFE seats and stuffing box ring
- blow-out proof stem
- adjustable packing gland



Male NPT x Female NPT	Port	Bronze Part #
1/2"	standard	<b>BMV50</b>
3/4"	standard	<b>BMV75</b>
1"	standard	<b>BMV100</b>

## "Deadman" Spring Return Handle Brass Ball Valves

**Features:**

- pressure rating: **600 PSI WOG**; **150 PSI** saturated steam
- vacuum service to 29 inches Hg
- stainless steel lever
- chromium plated ball
- RTFE seats and stuffing box ring
- blow-out proof stem design
- adjustable packing gland
- spring return closes valve when not held open
- operating torque approximately three times standard valve torque



Female NPT	Port	Brass Part #
1/2"	full	<b>BBV50SR</b>
3/4"	standard	<b>BBV75SR</b>
1"	standard	<b>BBV100SR</b>
1 1/2"	standard	<b>BBV150SR</b>
2"	standard	<b>BBV200SR</b>

### 250 Lb. Steam Ball Valves

Valves



**Application:**

- recommended for use with fluids with widely varying temperatures and/or thermal expansion rates

**Features:**

- pressure rating: **600 PSI**; **250 PSI** saturated steam
- vacuum service to 29 inches Hg
- bronze body
- 316 stainless steel ball and stem
- blow-out proof stem design
- multi-fill RPTFE seats
- multi-fill stuffing box ring
- high temperature MTFE stem packing
- adjustable packing gland
- maximum temperature: **450°F (232°C)**

Female NPT	Port	Bronze Part #
1/2"	full	<b>BBV50ST</b>
3/4"	standard	<b>BBV75ST</b>
1"	standard	<b>BBV100ST</b>
2"	standard	<b>BBV200ST</b>

### Safety Vented Ball Valves

**Application:**

- for air service only

**Features:**

- pressure rating: **0-125 PSI**
- vent downstream air in accordance with OSHA regulation 1910.147 for pneumatic systems
- bronze valve
- chromium plated ball
- RTFE seats and stuffing box ring
- blow-out proof stem design
- adjustable packing gland



sliding lock mechanism

Female NPT	Port	Bronze Part #
1/4"	full	<b>BBV25LV</b>
3/8"	full	<b>BBV38LV</b>
1/2"	full	<b>BBV50LV</b>
3/4"	standard	<b>BBV75LV</b>
1"	standard	<b>BBV100LV</b>
1 1/4"	standard	<b>BBV125LV</b>
1 1/2"	standard	<b>BBV150LV</b>
2"	standard	<b>BBV200LV</b>

### Bronze Ball Valves with NPT Tap for Drain

**Application:**

- recommended for water and air service

**Features:**

- pressure rating: **125 PSI** WOG
- vent downstream air in accordance with OSHA regulations for pneumatic systems
- chromium plated ball
- RTFE seats and stuffing box ring
- blow-out proof stem
- adjustable packing gland
- auto-drain / auto-vent
- 1/4" NPT tapped port provides additional options such as an air venting elbow or noise muffler



Female NPT	Port	Bronze Part #
1/4"	full	<b>BBV25VT</b>
3/8"	full	<b>BBV38VT</b>
1/2"	full	<b>BBV50VT</b>
3/4"	full	<b>BBV75VT</b>
1"	full	<b>BBV100VT</b>



## Imported Brass Ball Valves

**Application:**

- for control of air, water, oil and gas in hose or pipe lines, for other services please contact Dixon®

**Features:**

- pressure rating: **600 PSI WOG**; **150 PSI** Working Steam Pressure
- forged brass body
- blow-out proof stems
- PTFE seat, seal and thrust washer
- chrome-plated brass ball and plated steel handle
- maximum temperature: **366°F (186°C)**
- Underwriters Listed

**female NPT x female NPT**



Size	Port	Brass Part #
1/4"	full	<b>FBV25</b>
3/8"	full	<b>FBV38</b>
1/2"	full	<b>FBV50</b>
3/4"	full	<b>FBV75</b>
1"	full	<b>FBV100</b>
1 1/4"	full	<b>FBV125</b>
1 1/2"	full	<b>FBV150</b>
2"	full	<b>FBV200</b>



**female NPT x female NPT**



Size	Port	Brass Part #
2 1/2"	full	<b>FBV250</b>
3"	full	<b>FBV300</b>
4"	full	<b>FBV400</b>

## Imported Brass Ball Valve with Locking Handle

**Application:**

- for control of air, water, oil and gas in hose or pipe lines, for other services please contact Dixon®

**Features:**

- pressure ratings: **600 PSI WOG**; **150 PSI** Working Steam Pressure
- forged brass body
- blow-out proof stem
- PTFE seat, seal and thrust washer
- chrome-plated brass ball and plated steel handle
- maximum temperature: **366°F (186°C)**

Female NPT	Port	Brass Part #
1/2"	full	<b>FBVL50</b>
3/4"	full	<b>FBVL75</b>
1"	full	<b>FBVL100</b>
1 1/4"	full	<b>FBVL125</b>
1 1/2"	full	<b>FBVL150</b>
2"	full	<b>FBVL200</b>
2 1/2"	full	<b>FBVL250</b>
3"	full	<b>FBVL300</b>
4"	full	<b>FBVL400</b>



### Global Brass Ball Valves

Valves



**Application:**

- for water and air only

**Features:**

- pressure ratings:
  - ¼" - ¾" rated to **365 PSI**
  - ½" - 2" rated to **600 PSI**
- forged brass body
- maximum temperature: **248°F (120°C)**

Female NPT	Port	Forged Brass Part #
¼"	full	<b>FBVG25</b>
⅜"	full	<b>FBVG38</b>
½"	full	<b>FBVG50</b>
¾"	full	<b>FBVG75</b>
1"	full	<b>FBVG100</b>
1¼"	full	<b>FBVG125</b>
1½"	full	<b>FBVG150</b>
2"	full	<b>FBVG200</b>

### Solder End Brass Ball Valves

**Application:**

- provides protection against potential gas leakage under extreme duty or low pressure applications

**Features:**

- pressure rating: **600 PSI WOG; 150 PSI** working steam pressure
- maximum temperature: **366°F (186°C)**
- brass body
- blow-out proof stem
- chrome-plated brass ball
- adjustable stem packing nut
- PTFE seat, seal, and thrust washer



Size	Port	Brass Part #
½"	full	<b>FBV50SE</b>
¾"	full	<b>FBV75SE</b>
1"	full	<b>FBV100SE</b>
1¼"	full	<b>FBV125SE</b>
1½"	full	<b>FBV150SE</b>
2"	full	<b>FBV200SE</b>

### Lead Free Brass Ball Valves

**Features:**

- lead free refers to the wetted surface of pipes, fittings and fixtures in potable water systems that have a weighted average lead content = 0.25% Source: California Health & Safety Code (116875). Vermont Act 193\*171NLF
- pressure rating: **600 WOG - 150 WSP**
- maximum temperature: **366°F (186°C)**
- PTFE seat and double O-ring stem packing



Female NPT	Port	Lead Free Brass Part #
½"	full	<b>LFV50</b>
¾"	full	<b>LFV75</b>
1"	full	<b>LFV100</b>
1¼"	full	<b>LFV125</b>
1½"	full	<b>LFV150</b>
2"	full	<b>LFV200</b>

## Dual Y Valves

**Application:**

- ideal for compressor applications

**Features:**

- dual action valve
- non-vented pressure rating: **600 PSI WOG**
- vented pressure rating: **125 PSI** Cold Working Pressure

**Vented**

Female NPT Inlet (1)	Female NPT Outlets (2)	Bronze Part #
1"	3/4"	<b>BBV100DWV</b>
1 1/4"	3/4"	<b>BBV125DWV</b>

**Non-Vented**

Female NPT Inlet (1)	Female NPT Outlets (2)	Bronze Part #
1"	3/4"	<b>BBV100DW</b>
1 1/4"	3/4"	<b>BBV125DW</b>



Valves

## Mini Ball Valves



**Features:**

- pressure rating: **450 PSI**
- nickel plated brass body
- PTFE seats and FKM stem seal
- blow-out proof stem
- maximum temperature **330°F (166°C)**
- Canadian Standard Association approved

Female NPT	Port	Nickel Plated Brass Part #
1/8"	standard	<b>MBV12</b>
1/4"	standard	<b>MBV25</b>
3/8"	standard	<b>MBV38</b>
1/2"	standard	<b>MBV50</b>



### 3-Way Brass Diverting Ball Valves T Flow

female NPT x female NPT x female NPT

Valves



**Features:**

- pressure rating: **400 PSI WOG**; **100 PSI** saturated steam
- brass body
- blow-out proof stem
- chrome plated brass ball
- PTFE seats, seals, and thrust washer
- adjustable stem packing
- maximum temperature: **366°F (186°C)**

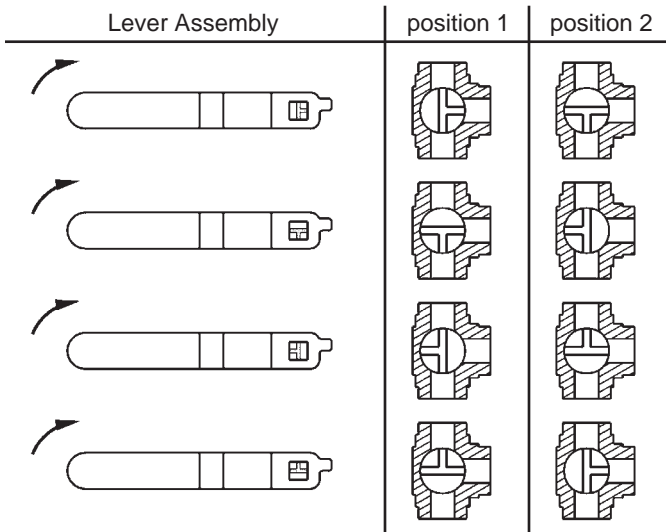

Size	Port	Brass Part #
1/2"	standard	<b>BBV50DTW</b>
3/4"	standard	<b>BBV75DTW</b>
1"	standard	<b>BBV100DTW</b>
1 1/4"	standard	<b>BBV125DTW</b>
1 1/2"	standard	<b>BBV150DTW</b>
2"	standard	<b>BBV200DTW</b>

Note: 1/4 turn handle can be adjusted to any orientation. Notches on the valve stem reflect the three openings on the ball.

### 3-Way Brass Diverting Ball Valves L Flow

female NPT x female NPT x female NPT



**Features:**

- can be used with gasoline and diesel fuel
- pressure rating: **400 PSI WOG**
- bronze body
- blow-out proof stem
- chromium-plated ball
- RPTFE seats and stuffing box ring
- stainless steel handle and nut with vinyl sleeve
- adjustable packing gland

Size	Port	Bronze Part #
1/2"	full	<b>BBV50TW</b> <sup>1</sup>
3/4"	standard	<b>BBV75TW</b>
1"	standard	<b>BBV100TW</b>

<sup>1</sup> carbon steel handle and nut with vinyl sleeve

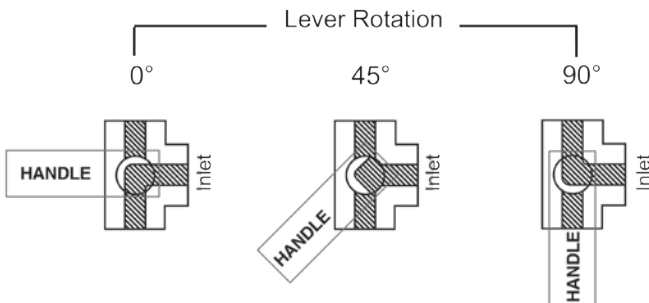

**Features:**

- rated to **800 PSI WOG**
- stainless steel body and ball
- blow-out proof stem
- RPTFE seats and stuffing box ring
- stainless steel handle and nut with vinyl sleeve
- adjustable packing gland
- meets NACE MR-01-75

Size	Port	Stainless Steel Part #
1/2"	full	<b>SSBV50TW</b>
3/4"	standard	<b>SSBV75TW</b>
1"	standard	<b>SSBV100TW</b>

## 2-Piece Domestic Stainless Steel Ball Valves

**Features:**

- pressure rating: **1,000 PSI** Cold Working Pressure
- pressure rating: **150 PSI** saturated steam
- vacuum service to 29 inches Hg
- 316 stainless body, ball and stem
- PTFE seal
- blow-out proof stem
- vinyl handle cover
- temperature range: **-40°F to 400°F (-40°C to 204°C)**

Female NPT	Port	316 Stainless Steel Part #
1/4"	full	<b>DSBV25</b>
3/8"	full	<b>DSBV38</b>
1/2"	full	<b>DSBV50</b>
3/4"	full	<b>DSBV75</b>
1"	full	<b>DSBV100</b>
1 1/4"	full	<b>DSBV125</b>
1 1/2"	full	<b>DSBV150</b>
2"	full	<b>DSBV200</b>

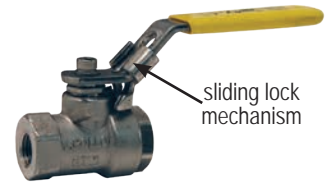

Valves

## Stainless Steel Ball Valves Full Port

**Applications:**

- for use with water, oil and gas

**Features:**

- pressure rating: 1/4" - 2" rated to **1000 PSI** WOG (CWP)  
2 1/2" - 3" rated to **800 PSI** WOG (CWP)  
**100 PSI** saturated steam
- 316 stainless steel body, ball and stem
- RPTFE seat, joint gasket and thrust washer
- blow-out proof stem design
- temperature range: **-20°F to 446°F (-29°C to 230°C)** as long as the valve is run fully open/ closed

Female NPT	Port	316 Stainless Steel Part #
1/4"	full	<b>SSBV25</b>
3/8"	full	<b>SSBV38</b>
1/2"	full	<b>SSBV50</b>
3/4"	full	<b>SSBV75</b>
1"	full	<b>SSBV100</b>
1 1/4"	full	<b>SSBV125</b>
1 1/2"	full	<b>SSBV150</b>
2"	full	<b>SSBV200</b>
2 1/2"	full	<b>SSBV250</b>
3"	full	<b>SSBV300</b>



## Stainless Steel Ball Valves Full Port with Locking Handle

**Applications:**

- for use with water, oil and gas

**Features:**

- pressure rating: ¼" - 2" rated to **1000 PSI** WOG (CWP)  
2½" - 3" rated to **800 PSI** WOG (CWP)  
**100 PSI** saturated steam
- 316 stainless steel body, ball and stem
- RPTFE seat, joint gasket and thrust washer
- plastic cover on handle
- blow-out proof stem design
- temperature range: **-20°F to 356°F (-29°C to 180°C)**
- lockable
- not recommended as a throttling valve

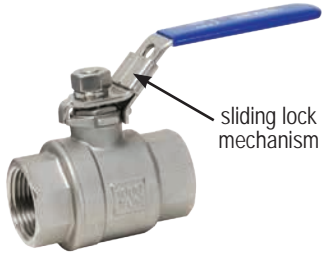

Female NPT	Port	316 Stainless Steel Part #
¼"	full	<b>SSLBV25</b>
⅜"	full	<b>SSLBV38</b>
½"	full	<b>SSLBV50</b>
¾"	full	<b>SSLBV75</b>
1"	full	<b>SSLBV100</b>
1¼"	full	<b>SSLBV125</b>
1½"	full	<b>SSLBV150</b>
2"	full	<b>SSLBV200</b>
2½"	full	<b>SSLBV250</b>
3"	full	<b>SSLBV300</b>

## Stainless Steel Ball Valves Reduced Port with Locking Handle

**Applications:**

- for use with water, oil and gas

**Features:**

- pressure rating: **1000 PSI** WOG; **100 PSI** saturated steam
- 316 stainless steel body, ball and stem
- RPTFE seat, joint gasket and thrust washer
- plastic cover on handle
- blow-out proof stem design
- temperature range: **-20°F to 356°F (-29°C to 180°C)**
- lockable
- not recommended as a throttling valve

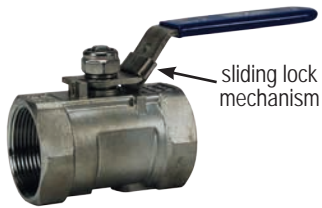

Female NPT	Port	316 Stainless Steel Part #
¼"	reduced	<b>SSLBV25SP</b>
⅜"	reduced	<b>SSLBV38SP</b>
½"	reduced	<b>SSLBV50SP</b>
¾"	reduced	<b>SSLBV75SP</b>
1"	reduced	<b>SSLBV100SP</b>
1¼"	reduced	<b>SSLBV125SP</b>
1½"	reduced	<b>SSLBV150SP</b>
2"	reduced	<b>SSLBV200SP</b>

### 3-Piece Industrial Stainless Steel Ball Valves FNPT

**Features:**

- blow out proof stem
- live-loaded stem packing
- swing out design for easy maintenance
- ISO 5211 mounting pad
- RTFE seat and seals
- maximum temperature: **400°F (200°C)**
- maximum pressure: 1/4" - 1/2" **1,000 PSI** WOG at 65°F, 2 1/2" - 3" **800 PSI** WOG at 65°F, 4" **600 PSI** WOG at 65°F

Female NPT	Port	PSI @ 65°F	Body Length	CF8M Stainless Steel Part #
1/2"	full	<b>1000</b>	2.8"	<b>BV2IGN05011-A</b>
3/4"	full	<b>1000</b>	3.1"	<b>BV2IGN07511-A</b>
1"	full	<b>1000</b>	3.3"	<b>BV2IGN10011-A</b>
1 1/4"	full	<b>1000</b>	4.1"	<b>BV2IGN12511-A</b>
1 1/2"	full	<b>1000</b>	4.4"	<b>BV2IGN15011-A</b>
2"	full	<b>1000</b>	5.1"	<b>BV2IGN20011-A</b>
2 1/2"	full	<b>800</b>	6.6"	<b>BV2IGN25011-A</b>
3"	full	<b>800</b>	7.3"	<b>BV2IGN30011-A</b>
4"	full	<b>600</b>	8.9"	<b>BV2IGN40011-A</b>



Valves

### 3-Piece Industrial Stainless Steel Ball Valves Socket Weld

Female NPT	Port	PSI @ 65°F	Body Length	CF8M Stainless Steel Part #
1/2"	full	<b>1000</b>	2.8"	<b>BV2IGN05033-A</b>
3/4"	full	<b>1000</b>	3.1"	<b>BV2IGN07533-A</b>
1"	full	<b>1000</b>	3.3"	<b>BV2IGN10033-A</b>
1 1/4"	full	<b>1000</b>	4.1"	<b>BV2IGN12533-A</b>
1 1/2"	full	<b>1000</b>	4.4"	<b>BV2IGN15033-A</b>
2"	full	<b>1000</b>	5.1"	<b>BV2IGN20033-A</b>
2 1/2"	full	<b>800</b>	6.6"	<b>BV2IGN25033-A</b>
3"	full	<b>800</b>	7.3"	<b>BV2IGN30033-A</b>
4"	full	<b>600</b>	8.9"	<b>BV2IGN40033-A</b>



### "Deadman" Spring Return Handle Stainless Steel Ball Valves

**Features:**

- pressure rating: **2000 PSI** WOG 1/2" to 1"; **1500 PSI** WOG 1 1/4" to 2"
- **150 PSI** saturated steam, all sizes
- vacuum service to 29 inches Hg, all sizes
- PTFE seal
- blow-out proof stem design
- adjustable packing gland
- spring return closes valve when not held open
- operating torque approximately three times standard valve torque

Female NPT	Port	316 Stainless Steel Part #
1/2"	full	<b>SSBV50SR</b>
3/4"	standard	<b>SSBV75SR</b>
1"	standard	<b>SSBV100SR</b>
1 1/4"	standard	<b>SSBV125SR</b>
1 1/2"	standard	<b>SSBV150SR</b>
2"	standard	<b>SSBV200SR</b>



## Industrial Wafer Ball Valves

Valves



**Features:**

- ANSI Class 150 wafer style ball valve
- full port, sizes 1" to 4"
- blow out proof stem
- ideal option to high performance butterflies
- space saving
- anti-static stem design
- locking plate included

**Materials:**

- body: CF8M
- ball and end connection: 316 stainless steel
- elastomers: FKM
- seats: 25% carbon reinforced PTFE

Size	Stainless Steel Part #
1"	<b>BV2IC-100WW-A</b>
1¼"	<b>BV2IC-125WW-A</b>
1½"	<b>BV2IC-150WW-A</b>
2"	<b>BV2IC-200WW-A</b>
2½"	<b>BV2IC-250WW-A</b>
3"	<b>BV2IC-300WW-A</b>
4"	<b>BV2IC-400WW-A</b>

## Mann Tek Full Flow Ball Valves

**Features:**

- high flow rate; low pressure drop
- wetted parts are aluminum and stainless steel
- FPM seals
- spindle can be disassembled even when ball valve is installed
- working pressure: **150 PSI** at ambient temperature **70°F (21°C)**
- standard valve ports - female NPT, socket weld for Schedule 40 pipe and grooved
- optional ports include DN flange, butt weld and 150# flange, contact Dixon® for details
- two ports - one inlet and one outlet



### One-Way Full Flow Ball Valve Female NPT

Size	Aluminum Part #
2"	<b>1WAYBV200</b>
3"	<b>1WAYBV300</b>
4"	<b>1WAYBV400</b>

### One-Way Full Flow Ball Valve Socket Weld



Size	Bore	Aluminum Part #
2"	2.390"	<b>1WAYBV200SW</b>
3"	3.530"	<b>1WAYBV300SW</b>

### One-Way Full Flow Ball Valve Grooved



Size	Aluminum Part #
2"	<b>1WAYBV200VIC</b>
3"	<b>1WAYBV300VIC</b>



Mann Tek Full Flow Ball Valves

Features:

- high flow rate; low pressure drop
- wetted parts are aluminum and stainless steel
- FPM seals
- spindle can be disassembled even when ball valve is installed
- working pressure: **150 PSI** at ambient temperature **70°F (21°C)**
- standard valve ports - female NPT, socket weld for Schedule 40 pipe and grooved
- optional ports include DN flange, butt weld and 150# flange, contact Dixon® for details
- three ports - one inlet and two outlets, valve directs the flow from the inlet to either of the two outlets
- commonly used for switching compartments or tanks



Valves

Two-Way Full Flow Ball Valve Female NPT

Size	Aluminum Part #
2"	<b>2WAYBV200</b>
3"	<b>2WAYBV300</b>
4"	<b>2WAYBV400</b>

Two-Way Full Flow Ball Valve Socket Weld

Size	Bore	Aluminum Part #
2"	2.390"	<b>2WAYBV200SW</b>
3"	3.530"	<b>2WAYBV300SW</b>



Two-Way Full Flow Ball Valve Grooved

Size	Aluminum Part #
2"	<b>2WAYBV200VIC3</b>
3"	<b>2WAYBV300VIC3</b>



## Carbon Steel Ball Valves

Valves



**Applications:**

- for control of air, water, oil and gas in hose or pipe lines, for other services please contact Dixon®

**Features:**

- pressure rating: **150 PSI** saturated steam
- carbon steel body
- chromium plated ball
- RPTFE seat and seal
- blow-out proof stem
- adjustable packing gland

Female NPT	PSI	Port	Carbon Steel Part #
1/4"	<b>2000</b>	full	<b>IBV25</b>
3/8"	<b>2000</b>	full	<b>IBV38</b>
1/2"	<b>2000</b>	standard	<b>IBV50</b>
3/4"	<b>2000</b>	standard	<b>IBV75</b>
1"	<b>2000</b>	standard	<b>IBV100</b>
1 1/4"	<b>1500</b>	standard	<b>IBV125</b>
1 1/2"	<b>1500</b>	standard	<b>IBV150</b>
2"	<b>1500</b>	standard	<b>IBV200</b>

## High Pressure Full-Bore Ball Valves

**Features:**

- blow-out proof stem
- rugged construction
- FKM/FPM seals
- POM (Polyacetal) ball seats



Female NPT	PSI	Carbon Steel		PSI	316 Stainless Steel Part #
		Part #	SAE Part #		
1/4"	<b>7350</b>	<b>HPBV25</b>	<b>HPBV25SAE</b>	<b>5880</b>	<b>HPBV25SS</b>
3/8"	<b>7350</b>	<b>HPBV38</b>	<b>HPBV38SAE</b>	<b>5880</b>	<b>HPBV38SS</b>
1/2"	<b>7350</b>	<b>HPBV12</b>	<b>HPBV12SAE</b>	<b>5880</b>	<b>HPBV12SS</b>
3/4"	<b>6000</b>	<b>HPBV34</b>	<b>HPBV34SAE</b>	<b>5145</b>	<b>HPBV34SS</b>
1"	<b>6000</b>	<b>HPBV10</b>	<b>HPBV10SAE</b>	<b>5145</b>	<b>HPBV10SS</b>
1 1/4"	<b>6000</b>	<b>HPBV125</b>	<b>HPBV125SAE</b>	---	---
1 1/2"	<b>6000</b>	<b>HPBV150</b>	<b>HPBV150SAE</b>	---	---
2"	<b>6000</b>	<b>HPBV200</b>	<b>HPBV200SAE</b>	---	---

## High Pressure Full-Bore **3-Way** Ball Valves

**Features:**

- temperature range: **-20°F to 215° F (-29°C to 102°C)**
- rugged construction
- FKM seals
- POM (polyacetal) ball seats
- black oxide coating
- nickel plated ball



Standard L 90°

Female NPT	PSI	Carbon Steel Part #
1/2"	<b>5145</b>	<b>HPBV12-3WAY</b>
3/4"	<b>5145</b>	<b>HPBV34-3WAY</b>
1"	<b>5145</b>	<b>HPBV10-3WAY</b>

## 150# Flanged Ball Valves

**Applications:**

- suitable for air, water, oil and gas

**Features:**

- product approvals include: LP gas shut-off valves, flammable liquid shut-off valves, gas shut-off valves, compressed gas shut-off valves, and anhydrous ammonia shut-off valves
- body: ASTM A216 WCB
- RPTFE seat
- vacuum service to 29 inches of Hg
- pressure rating: **150 PSIG** saturated steam
- temperature up to **400°F (204°C)**
- PSI rating up to **280 PSI**
- four point ISO 5211 mounting pad bolt pattern
- anti-static grounded ball and stem
- blow-out proof stem design
- bleed/drain port (cast) 1/2" NPT
- fire safe (graphite packing and seal)
- adjustable packing gland



Size	Port	Carbon Steel Part #
2"	full	<b>FLBV200CS</b>
2½"	full	<b>FLBV250CS</b>
3"	full	<b>FLBV300CS</b>
4"	full	<b>FLBV400CS</b>
6"	full	<b>FLBV600CS</b>
8"	full	<b>FLBV800CS</b>

- For flange dimensions, diagrams and additional information please reference [dixonvalve.com](http://dixonvalve.com).

## Polypropylene Bolted Ball Valves

**Features:**

- pressure rating: ½" - 3" is rated to **125 PSI** at **70°F (21°C)**  
4" is rated to **90 PSI** at **70°F (21°C)**
- chemically-resistant, reinforced polypropylene
- PTFE ball seat
- EPDM O-ring body seal, FKM O-ring stem seal
- 304 stainless steel nuts and bolts
- FDA approved material

### Polypropylene 4-Bolt Ball Valves

Female NPT	Port	Polypropylene Part #
½"	full	<b>PVFP50</b>
¾"	full	<b>PVFP75</b>
1"	full	<b>PVFP100</b>
1½"	full	<b>PVFP150</b>
1"	standard	<b>PV100</b>
2"	standard	<b>PV200</b>



### Polypropylene 6-Bolt Ball Valves

Female NPT	Port	Polypropylene Part #
2"	full	<b>PVFP200</b>
3"	full	<b>PVFP300</b>



### Polypropylene 8-Bolt Ball Valves

Female NPT	Port	Polypropylene Part #
4"	full	<b>PVFP400</b>



### Polypropylene Compact Bolted Ball Valves

**Features:**

- pressure rating: **125 PSI at 70°F (21°C)**
- chemically-resistant, reinforced polypropylene body, PTFE ball seat
- EPDM O-ring body seal, FKM O-ring stem seals
- 304 stainless steel nuts and bolts
- FDA approved material



#### Polypropylene Compact Bolted Ball Valve

Female NPT	Port	Body Length	Polypropylene Part #
2"	full	4 <sup>7</sup> / <sub>8</sub> "	<b>PVFPS200</b>



#### Polypropylene Compact Bolted Ball Valve

Female NPT x Male Adapter	Port	Body Length	Polypropylene Part #
2"	full	6 <sup>7</sup> / <sub>8</sub> "	<b>PVFPSA200</b>

### Polypropylene 45° Single Union Nozzle Valves

**Features:**

- pressure rating: **125 PSI at 70°F (21°C)**
- corrosion resistant polypropylene body, PTFE ball seats
- EPDM O-ring
- FDA approved material



Female NPT x Nozzle	Port	Polypropylene Part #
1"	full	<b>SUBVN100</b>

### Polypropylene Bolted Ball Valves with Nozzle

**Features:**

- pressure rating: **125 PSI at 70°F (21°C)**
- chemically-resistant, reinforced polypropylene body, PTFE ball seat
- EPDM O-ring body seals, FKM O-ring stem seals
- 304 stainless steel nuts and bolts
- FDA approved material
- body-to-flange design allows for low torque operation



Female NPT x Nozzle	Port	Polypropylene Part #
1 <sup>1</sup> / <sub>2</sub> "	full	<b>PVFPN150</b>
2"	full	<b>PVFPN200</b>
2"	standard	<b>PVN200</b>

### Polypropylene Single Union Ball Valves

**Features:**

- pressure rating: **125 PSI at 70°F (21°C)**
- corrosion resistant polypropylene body, PTFE ball seat
- EPDM O-ring
- FDA approved material



Female NPT	Port	Polypropylene Part #
1/2"	full	<b>SUBV50</b>
3/4"	full	<b>SUBV75</b>
1"	full	<b>SUBV100</b>
1 1/4"	full	<b>SUBV125</b>
1 1/2"	full	<b>SUBV150</b>
2"	full	<b>SUBV200</b>
3"	full	<b>SUBV300</b>

Domestic Bronze Gate Valves

Features:

- Class 150
- pressure rating: **300 PSI** cold working pressure, **150 PSI** steam working pressure
- union bonnet
- ASME B1.20.1
- Grafoil® packing
- rising stem
- solid disc
- malleable iron handwheel
- 100% factory tested
- temperature range: **-20°F to 406°F (-29°C to 208°C)**

Female NPT	Bronze Part #
½"	<b>DBGV50</b>
¾"	<b>DBGV75</b>
1"	<b>DBGV100</b>
1¼"	<b>DBGV125</b>
1½"	<b>DBGV150</b>
2"	<b>DBGV200</b>



Valves

Stainless Steel Gate Valves

Features:

- pressure rating: **200 PSI** non-shock cold water, oil, gas
- threaded bonnet
- integral seat
- adjustable packing nut
- non-rising stem
- solid wedge disc
- iron handwheel
- 100% factory tested

Female NPT	Brass Part #	316 Stainless Steel Part #
¼"	<b>BGV25</b>	---
⅜"	<b>BGV38</b>	---
½"	<b>BGV50</b>	<b>SSGV50</b>
¾"	<b>BGV75</b>	<b>SSGV75</b>
1"	<b>BGV100</b>	<b>SSGV100</b>
1¼"	<b>BGV125</b>	<b>SSGV125</b>
1½"	<b>BGV150</b>	<b>SSGV150</b>
2"	<b>BGV200</b>	<b>SSGV200</b>
2½"	<b>BGV250</b>	---
3"	<b>BGV300</b>	---
4"	<b>BGV400</b>	---



brass



316 stainless

Forged Steel Gate Valves

Application:

- can be used for steam service

Features:

- Class 800
- ASTM A105, ANSI B120.1
- bolted bonnet
- pressure rating: **1975 PSI**
- maximum temperature: **800°F (427°C)**

Female NPT	Forged Steel Part #
½"	<b>FSGV50</b>
¾"	<b>FSGV75</b>
1"	<b>FSGV100</b>
1¼"	<b>FSGV125</b>
1½"	<b>FSGV150</b>
2"	<b>FSGV200</b>



### Domestic Bronze Globe Valves

**Features:**

- Class 150
- pressure rating: **300 PSI** cold working pressure, **150 PSI** steam working pressure
- union bonnet
- ASME B1.20.1
- Grafoil® packing
- PTFE disc
- malleable iron handwheel
- 100% factory tested



Female NPT	Bronze Part #
1/2"	<b>DGLBV50</b>
3/4"	<b>DGLBV75</b>
1"	<b>DGLBV100</b>
1 1/4"	<b>DGLBV125</b>
1 1/2"	<b>DGLBV150</b>
2"	<b>DGLBV200</b>

### Forged Steel Globe Valves

**Features:**

- Class 800
- ASTM A105, ANSI B120.1
- bolted bonnet
- pressure rating: **1975 PSI**
- maximum temperature: **800°F (427°C)**
- can be used for steam service



Female NPT	Forged Steel Part #
1/2"	<b>FSGLBV50</b>
3/4"	<b>FSGLBV75</b>
1"	<b>FSGLBV100</b>
1 1/4"	<b>FSGLBV125</b>
1 1/2"	<b>FSGLBV150</b>
2"	<b>FSGLBV200</b>

### Betts Wet-R-Dri™ Butterfly Valves

**Application:**

- designed for handling liquid, gaseous or dry products

**Features:**

- has a positive stop in the open and closed position
- detent spring and ball assist in holding the disc in the open and closed position
- drilling fits TTMA recommended standards
- opens by turning hand 1/4 turn counter clockwise
- temperature range: **0°F to 400°F (-17°C to 204°C)**

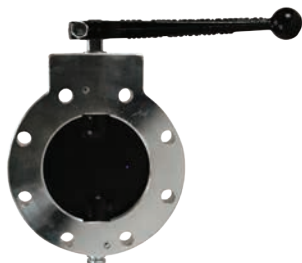

**Manual**

Size	Maximum Working Pressure PSI	Extruded aluminum body with FKM-B disc Part #
3"	<b>75</b>	<b>WD301ALVB</b>
4"	<b>75</b>	<b>WD401ALVB</b>

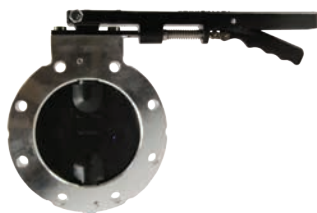

**Metering**

Size	Maximum Working Pressure PSI	Extruded aluminum body with FKM-B disc Part #
3"	<b>75</b>	<b>WD304ALVB</b>
4"	<b>75</b>	<b>WD404ALVB</b>

• For flange dimensions, diagrams and additional information please reference [dixonvalve.com](http://dixonvalve.com).

## Ductile Iron Butterfly Valves

 NOT RECOMMENDED FOR STEAM SERVICE

- for use between two 150 lb. flanges
- 10 position trigger grip handle
- pressure rating: **200 PSI** at ambient temperature **70°F (21°C)**

### Threaded Lug Style Butterfly Valves

**Features:**

- ductile iron body, ASTM A536
- aluminum bronze disc, ASTM B148, ALY.954
- PTFE bushing
- stainless steel top and bottom stems

Size	Ductile Iron with Buna-N Liner Part #	Ductile Iron with EPDM Liner Part #
2"	<b>BFVL200</b>	<b>BFVL200E</b>
3"	<b>BFVL300</b>	<b>BFVL300E</b>
4"	<b>BFVL400</b>	<b>BFVL400E</b>
6"	<b>BFVL600</b>	<b>BFVL600E</b>



Valves

### Wafer Style 150 lb. Butterfly Valves with Aluminum Bronze Disc

**Features:**

- ductile iron body, ASTM A536
- aluminum bronze disc, ASTM B148, ALY.954
- PTFE bushing
- stainless steel top and bottom stems

Size	Ductile Iron with Buna-N Liner Part #	Ductile Iron with EPDM Liner Part #
2"	<b>BBFVW200</b>	<b>BBFVW200E</b>
3"	<b>BBFVW300</b>	<b>BBFVW300E</b>
4"	<b>BBFVW400</b>	<b>BBFVW400E</b>
6"	<b>BBFVW600</b>	<b>BBFVW600E</b>



### Wafer Style 150 lb. Butterfly Valves with Stainless Disc

**Features:**

- ductile iron body, ASTM A536
- stainless steel disc, ASTM A351, GR. CF-8M
- Buna-N seal and stem seals
- PTFE bushing
- stainless steel top and bottom stems

Size	Ductile Iron with Buna-N Liner Part #
2"	<b>BFVW200</b>
3"	<b>BFVW300</b>
4"	<b>BFVW400</b>
6"	<b>BFVW600</b>



### Wafer Style 150 lb. Butterfly Valves with Iron Disc

**Features:**

- ductile iron body, ASTM A536
- nickel plated ductile iron disc
- Buna-N seal and stem seals
- PTFE bushing
- 416 stainless stem

Size	Ductile Iron with Buna-N Liner Part #	Ductile Iron with EPDM Liner Part #
3"	<b>IBFVW300</b>	<b>IBFVW300E</b>
4"	<b>IBFVW400</b>	<b>IBFVW400E</b>
6"	<b>IBFVW600</b>	<b>IBFVW600E</b>
8"	<b>IBFVW800</b>	<b>IBFVW800E</b>



Flow Control Valves

Steel Series F

Valves



Features:

- Two-step needle provides fine adjustments at low flow with the first three turns of the adjusting knob. The next three turns give full-open needle position and conventional throttling control. When flow is reversed, a heavy-duty poppet/retainer permits full-flow return capacity.
- color-coded reference scale simplifies flow setting, resetting, adjusting and return to original flow, a simple set screw locks the valve on any desired setting.
- maximum operating pressure: **5000 PSI at 70°F (21°C)** for 1/8" - 1/2", **3000 PSI at 70°F (21°C)** for 3/4" - 2"

Female NPTF	Black Oxide Steel Part #
1/8"	<b>SFC200</b>
1/4"	<b>SFC400</b>
3/8"	<b>SFC600</b>
1/2"	<b>SFC800</b>
3/4"	<b>SFC1200</b>
1"	<b>SFC1600</b>
1 1/2"	<b>SFC2400</b>
2"	<b>SFC3200</b>

Brass Series F

Features:

- provides precision flow control and full shutoff in one flow direction, automatically allows unrestricted flow in the opposite direction
- two-step needle for fine adjustments at low flow with first 3 turns of the adjusting knob, next 3 turns give full-open needle position and conventional throttling control
- when flow is reversed the heavy-duty poppet/retainer permits full flow return capacity
- color coded scale simplifies flow setting, resetting, adjusting and return to an original flow
- a set screw locks the valve on any desired setting
- maximum operating pressure: **2000 PSI** at ambient temperature **70°F (21°C)** for sizes 1/8" - 3/4", **500 PSI** at ambient temperature **70°F (21°C)** for 1"



Female NPTF	Brass Part #
1/8"	<b>BFC200</b>
1/4"	<b>BFC400</b>
3/8"	<b>BFC600</b>
1/2"	<b>BFC800</b>
3/4"	<b>BFC1200</b>
1"	<b>BFC1600</b>

Series MV Metering

Features:

- easily make fine adjustments and resets with color code feature that shows when desired setting is reached
- body components are precision-turned from solid barstock
- 416 stainless steel needle
- maximum operating pressure: **5000 PSI at 70°F (21°C)**



Female NPTF	Steel Part #
1/4"	<b>SMV400</b>
3/8"	<b>SMV600</b>
1/2"	<b>SMV800</b>



## Flow Control Valves

### Steel Series PF

**Features:**

- recommended for use in non-shock applications
- ball type check meters the flow of hydraulic oil in one direction and allows for free flow in the reverse direction
- maximum operating pressure: **5000 PSI at 70°F (21°C)**, cracking pressure: **5 PSI**

Female NPTF	Zinc Plated Steel with a dichromate seal Part #
1/4"	<b>SPF400</b>
3/8"	<b>SPF600</b>
1/2"	<b>SPF800</b>



Valves

### Brass Series PF

**Features:**

- ball type check meters flow of air in one direction and allows free flow in the reverse direction
- used to control actuator speed by acting as a restriction
- maximum operating pressure: **2000 PSI at ambient temperature 70°F (21°C)**
- cracking pressure: **5 PSI**

Female NPTF	Brass Part #
1/8"	<b>BPF200</b>
1/4"	<b>BPF400</b>
3/8"	<b>BPF600</b>
1/2"	<b>BPF800</b>



### Steel Series N

**Features:**

- excellent speed control on hydraulic systems where a reverse flow check valve is not needed
- reliable shutoff in a very small envelope; color-coded reference scale simplifies setting, resetting, adjusting and quick return to a previous speed setting
- maximum operating pressure: **5000 PSI at 70°F (21°C)** for 1/8" - 3/4", **3000 PSI at 70°F (21°C)** for 1" - 1 1/4"

Female NPTF	Steel Part #
1/8"	<b>SN200</b>
1/4"	<b>SN400</b>
3/8"	<b>SN600</b>
1/2"	<b>SN800</b>
3/4"	<b>SN1200</b>
1"	<b>SN1600</b>
1 1/4"	<b>SN2000</b>



### Brass Series N

**Features:**

- for use as speed control on hydraulic and pneumatic systems where a reverse flow check valve is not needed
- provides excellent control and reliable shutoff in a very small envelope
- color coded scale simplifies setting, resetting, adjusting and quick return to a previous speed setting
- maximum operating pressure: **2000 PSI at ambient temperature 70°F (21°C)** for sizes 1/8" - 3/4", **500 PSI at ambient temperature 70°F (21°C)** for 1"

Female NPTF	Brass Part #
1/8"	<b>BN200</b>
1/4"	<b>BN400</b>
3/8"	<b>BN600</b>
1/2"	<b>BN800</b>
3/4"	<b>BN1200</b>
1"	<b>BN1600</b>



### Mini Needle Valves

**Features:**

- available in a variety of materials and handle options
- FKM O-ring seal and PTFE back-up ring below the threads protects from corrosion and galling
- stem threads are rolled for strength and ease of operation
- metal-to-metal hard seat design is 100% helium leak tested to 1 x 10<sup>-4</sup> ml/s at 200 PSI
- 1/8" and 1/4" are orifice size: 0.172", flow coefficient: 0.42
- 1/2": orifice size are 0.187", flow coefficient: 0.44, hex body
- all stems are 316 stainless steel

**Male to Female**



NPT Size	Handle Style	PSI @ 200°F	Brass Part #	Handle Style	PSI at 200°F	Zinc Nickel Plated Steel Part #	316 Stainless Steel Part #
1/8" - 27	knurled knob	6000	<b>MFB101</b>	T design	10000	<b>MFC101</b>	<b>MFS101</b>
1/4" - 18	knurled knob	6000	<b>MFB102</b>	T design	10000	<b>MFC102</b>	<b>MFS102</b>
1/2" - 14	---	---	---	T design	10000	<b>MFC404</b>	<b>MFS404</b>

**Female to Female**



NPT Size	Handle Style	PSI at 200°F	Brass Part #	Handle Style	PSI at 200°F	Zinc Nickel Plated Steel Part #	316 Stainless Steel Part #
1/8" - 27	knurled knob	6000	<b>FFB101</b>	T design	10000	<b>FFC101</b>	<b>FFS101</b>
1/4" - 18	knurled knob	6000	<b>FFB102</b>	T design	10000	<b>FFC102</b>	<b>FFS102</b>
1/2" - 14	---	---	---	T design	10000	<b>FFC404</b>	<b>FFS404</b>

### Multiport Needle Valves

**Features:**

- reduces the number of gauge and other instrument connections to permanent piping installations, decreasing possible leak paths
- FKM O-ring seal and PTFE back-up ring below the threads protects from corrosion and galling
- stem threads are rolled for strength and ease of operation
- metal-to-metal hard seat design is 100% helium leak tested to 1 x 10<sup>-4</sup> ml/s at 200 PSI
- 1/2" female NPT port
- orifice size is 0.187", flow coefficient: 0.44
- all stems are 316 stainless steel

**Hard Seat Male to Female**



NPT Size	Handle Style	PSI at 200°F	Zinc Nickel Plated Steel Part #	316 Stainless Steel Part #
1/2" - 14	T design	10000	<b>MFC204</b>	<b>MFS204</b>
3/4" - 14	T design	10000	<b>MFC20604</b>	<b>MFS20604</b>

**Soft Seat Male to Female**



NPT Size	Handle Style	PSI at 200°F	Zinc Nickel Plated Steel Part #	316 Stainless Steel Part #
1/2" - 14	T design	6000	<b>MFC304</b>	<b>MFS304</b>
3/4" - 14	T design	6000	<b>MFC30604</b>	<b>MFS30604</b>

## Block and Bleed Needle Valves

## Features:

- allows pressure to be bled off without disturbing the permanent piping installation allowing quick and easy removal or replacement of instruments
- FKM O-ring seal and PTFE back-up ring below the threads protects from corrosion and galling
- stem threads are rolled for strength and ease of operation
- metal-to-metal hard seat design is 100% helium leak tested to  $1 \times 10^{-4}$  ml/s at 200 PSI
- orifice size is 0.187", flow coefficient: 0.44
- all stems are 316 stainless steel
- 0.090" bleed hole located on bottom is controlled by a ¼"-20 UNF-2A bleed screw

## Hard Seat Male to Female

NPT Size	Handle Style	PSI at 200°F	Zinc Nickel Plated Steel Part #	316 Stainless Steel Part #
¼" - 18	T design	<b>10000</b>	<b>MFC602</b>	<b>MFS602</b>
½" - 14	T design	<b>10000</b>	<b>MFC604</b>	<b>MFS604</b>



## Soft Seat Male to Female

NPT Size	Handle Style	PSI at 200°F	Zinc Nickel Plated Steel Part #	316 Stainless Steel Part #
¼" - 18	T design	<b>6000</b>	<b>MFC702</b>	<b>MFS702</b>
½" - 14	T design	<b>6000</b>	<b>MFC704</b>	<b>MFS704</b>



## Bleed Needle Valves

## Features:

- convenient way to relieve process pressures trapped between a shut-off valve and the instrument
- FKM O-ring seal and PTFE back-up ring below the threads protects from corrosion and galling
- stem threads are rolled for strength and ease of operation
- metal-to-metal hard seat design is 100% helium leak tested to  $1 \times 10^{-4}$  ml/s at 200 PSI
- non-rotating soft tip stem and a backup metal-to-metal seal
- all stems are 316 stainless steel
- 0.159" bleed port

## Hard Seat Male

NPT Size	Handle Style	PSI at 200°F	Zinc Nickel Plated Steel Part #	316 Stainless Steel Part #
¼" - 18	T design	<b>10000</b>	<b>MC802</b>	<b>MS802</b>
½" - 14	T design	<b>10000</b>	<b>MC804</b>	<b>MS804</b>



316 stainless

## Soft Tip Male

NPT Size	Handle Style	PSI at 200°F	Zinc Nickel Plated Steel Part #	316 Stainless Steel Part #
¼" - 18	T design	<b>6000</b>	<b>MC852</b>	<b>MS852</b>
½" - 14	T design	<b>6000</b>	<b>MC854</b>	<b>MS854</b>



316 stainless

Valves

Button

Valves

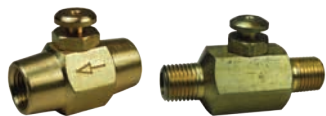

Thread	Brass Part #
1/4" NPT female	<b>BV2F</b>
1/4" NPT male	<b>BV2M</b>

Tank Filler



TFV1S

TFV2

Applications:

- used on compressed air tanks and other applications

Feature:

- standard valve stem thread



TFV1L

TFV2HB

Connection	Length	Nickel Plated Part #	Length	Brass Part #
1/8" NPT	.85"	<b>TFV1S</b>	---	---
	1.24"	<b>TFV1L</b>	---	---
1/4" NPT	1"	<b>TFV2</b>	---	---
1/4" barb	---	---	1.57"	<b>TFV2HB</b>

Brass Lever External Drains

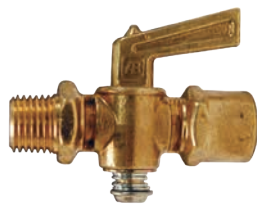

Application:

- for air service only 

Feature:

- maximum operating pressure: **30 PSI** at ambient temperature **70°F (21°C)**

Female NPT	Male NPT	Brass Part #
1/4"	1/4"	<b>LDC2</b>

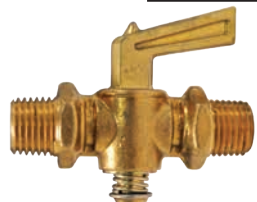

Male NPT	Male NPT	Brass Part #
1/4"	1/4"	<b>LDCM2</b>

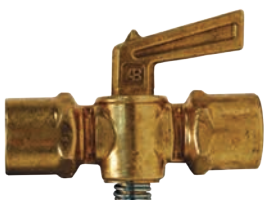

Female NPT	Female NPT	Brass Part #
1/4"	1/4"	<b>LDCF2</b>

Brass External Drain Cocks

Applications:

- designed for low pressure water and air applications

Feature:

- maximum operating pressure: **150 PSI** at ambient temperature **70°F (21°C)**



NPT Size	Brass Part #
1/8"	<b>D02</b>
1/4"	<b>D04</b>

Needle Valves

Features:

- metal-to-metal seats allow positive sealing and flow adjustment
- designed for air and water applications
- maximum working pressure: **150 PSI** at ambient temperature **70°F (21°C)**

female x female

Female NPT	Female NPT	Brass Part #
1/8"	1/8"	<b>NV2F</b>
1/4"	1/4"	<b>NV4F</b>

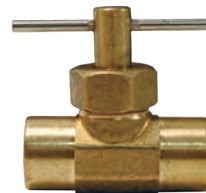

Valves

male x male

Male NPT	Male NPT	Brass Part #
1/4"	1/4"	<b>NV4M</b>

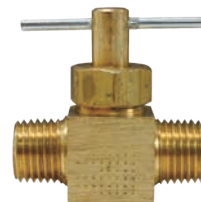

## Safety Check Valves

Valves

**Application:**

- used in temporary plant/factory air lines, construction sites, shipyards or utilities
- not for use in applications where 100% of the available air is required, i.e. sand blast, pile driving rigs, expansion joint blow down pipes, etc.



**Features:**

- high flow valve provides optimum performance
- controls excess air flow (SCFM) in only one direction
- automatically senses change in air flow and shuts off the flow in the event of a surge in excess of valve flow rating thus preventing hose whip
- solid brass body and valve
- stainless steel spring and roll pin
- maximum operating pressure: **350 PSI**
- maximum temperature: **250°F (121°C)**
- does not prevent backflow

**Specification:**

- conforms to OSHA regulation 1926.302 (b) (7) requiring a safety device at the source of the air supply and at branch air lines

**How It Works:**

- Safety check valves utilize the pressure differential across the valve to operate the valve and spring assembly. The pressure differential is directly related to the flow of air (SCFM) through the valve.
- When the pressure differential is within the operating limits - below the cutoff flow - of the unit, the force on the valve exerted by the spring is greater than that caused by the pressure differential (see "Open Position" graphic above). The valve remains open and normal operation continues.
- When the pressure differential is above the cutoff limit, the force on the valve exerted by the pressure differential is greater than the force exerted by the spring, and the valve closes (see the "Closed Position" graphic above).
- After the repair is made, normal operation is automatically enabled when pressure across the valve equalizes through the bleeder hole.
- The valve spring size can be specified by determining the air flow during normal operation and by estimating the air flow if a failure or rupture occurs.

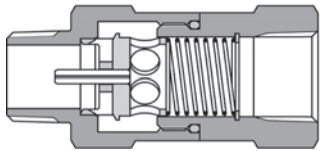
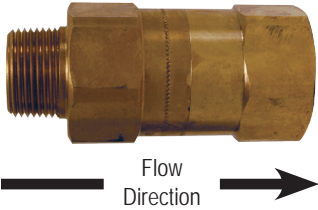

Open Position

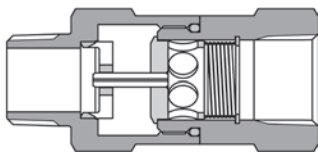

Closed Position

NPT & Hose ID Size	Cut-off Flow Rate (SCFM at 90 PSI)	Brass Part #	NPT & Hose ID Size	Cut-off Flow Rate (SCFM at 90 PSI)	Brass Part #
1/4"	23-29	<b>SCVL2</b>	1 1/4"	260-290	<b>SCVL10</b>
	30-36	<b>SCVL3</b>		300-340	<b>SCVM10</b>
3/8"	39-47	<b>SCVM3</b>		440-500	<b>SCVS10</b>
	52-65	<b>SCVS3</b>		570-630	<b>SCVH10</b>
1/2"	70-78	<b>SCVM4</b>	1 1/2"	300-360	<b>SCVL12</b>
	80-96	<b>SCVS4</b>		470-530	<b>SCVM12</b>
3/4"	72-88	<b>SCVL6</b>		564-602	<b>SCVX12</b>
	92-108	<b>SCVM6</b>		640-720	<b>SCVS12</b>
	112-128	<b>SCVR6</b>	750-830	<b>SCVH12</b>	
	132-148	<b>SCVJ6</b>	2"	510-590	<b>SCVL16</b>
160-180	<b>SCVS6</b>	725-825		<b>SCVM16</b>	
180-200	<b>SCVH6</b>	900-1050		<b>SCVS16</b>	
	<b>SCVL8</b>	1100-1200		<b>SCVH16</b>	
1"	165-195	<b>SCVL8</b>	3"	1200-1400	<b>SCVL24</b>
	220-260	<b>SCVM8</b>		2400-2700	<b>SCVS24</b>
	280-320	<b>SCVS8</b>		2850-3050	<b>SCVH24</b>
	310-340	<b>SCVH8</b>			

## Safety Pop-Off Valves

**Applications:**

- for use on compressors and in compressed air service

**Features:**

- designed to protect un-fired pressure vessels from over-pressure
- ASME Code, National Board Certified
- CSA B51-03 certified
- maximum temperature: **400°F (204°C)**

### Soft Seat

**Feature:**

- constructed of precision machined brass bar stock with a silicone disc sealing on the brass

Male NPT	Preset Pressure PSI	SCFM	Brass Part #
1/4"	<b>100</b>	51	<b>KSV10-100</b>
	<b>125</b>	62	<b>KSV10-125</b>
	<b>150</b>	73	<b>KSV10-150</b>
	<b>175</b>	84	<b>KSV10-175</b>



### Standard

**Features:**

- brass valves are supplied with a stainless steel ball
- stainless valves are all stainless construction with a soft seat

Male NPT	Preset Pressure PSI	SCFM	Brass Part #	SCFM	Stainless Steel Part #
1/4"	<b>30</b>	35	<b>SV30</b>	35	<b>SV30SS</b>
	<b>100</b>	89	<b>SV100</b>	92	<b>SV100SS</b>
	<b>125</b>	109	<b>SV125</b>	112	<b>SV125SS</b>
	<b>150</b>	129	<b>SV150</b>	132	<b>SV150SS</b>
	<b>175</b>	149	<b>SV175</b>	153	<b>SV175SS</b>
	<b>200</b>	168	<b>SV200</b>	173	<b>SV200SS</b>



### Heavy Duty, High Capacity

**Feature:**

- all brass construction with stainless steel ball on a precision machined brass seat

Male NPT	Preset Pressure PSI	SCFM	Brass Part #
1/2"	<b>30</b>	73	<b>SV30HD<sup>1</sup></b>
	<b>100</b>	208	<b>SV100HD</b>
	<b>125</b>	254	<b>SV125HD</b>
	<b>150</b>	300	<b>SV150HD</b>
	<b>175</b>	346	<b>SV175HD</b>
	<b>200</b>	391	<b>SV200HD</b>



<sup>1</sup> constructed with soft seat

Series C Check Valves

Valves



brass



steel

Features:

- provides free flow in one direction and dependable shutoff in the opposite direction
- maximum operating pressure: **2000 PSI** at ambient temperature **70°F (21°C)**
- cracking pressure: **5 PSI**

Female NPT	Free Flow GPM	Maximum Operating PSI at 70°F (21°C)	Brass Part #	Maximum Operating PSI at 70°F (21°C)	Steel Part #
1/8"	3	<b>2000</b>	<b>BCV200</b>	<b>5000</b>	<b>SCV200</b>
1/4"	5	<b>2000</b>	<b>BCV400</b>	<b>5000</b>	<b>SCV400</b>
3/8"	8	<b>2000</b>	<b>BCV600</b>	<b>5000</b>	<b>SCV600</b>
1/2"	15	<b>2000</b>	<b>BCV800</b>	<b>5000</b>	<b>SCV800</b>

Domestic Ball Cone Check Valves

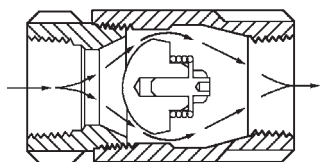

Pressure Ratings

Temperature	Pressure WOG (PSI)
-20°F to 100°F (-29°C to 38°C)	400
200°F (93°C)	200
250°F (121°C)	160
275°F (135°C)	150
300°F (149°C)	140
325°F (163°C)	130
353°F (178°C)	125

Application:

- For use with water, oil or inert gases. Not recommended for use on or near reciprocating pumps or other similar vibration causing machinery.

Features:

- tight shut-off with liquid media
- no radial alignment necessary
- straight through and streamlined for minimum change in velocity
- Reinforced PTFE check is spring loaded for fast seating action.
- pressure rating: **400 PSI** WOG, cold non-shock; **125 PSI** saturated steam
- cracking pressure: **.5 PSI**
- temperature range: **-20°F to 353°F (-29°C to 178°C)**

Ball Cone Check Valve Female NPT x Female NPT



Size	Brass Part #	316 Stainless Steel Part #
1/4"	<b>61-101</b>	<b>62-101</b>
3/8"	<b>61-102</b>	<b>62-102</b>
1/2"	<b>61-103</b>	<b>62-103</b>
3/4"	<b>61-104</b>	<b>62-104</b>
1"	<b>61-105</b>	<b>62-105</b>
1 1/4"	<b>61-106</b>	<b>62-106</b>
1 1/2"	<b>61-107</b>	<b>62-107</b>
2"	<b>61-108</b>	<b>62-108</b>
2 1/2"	<b>61-109</b>	---
3"	<b>61-100</b>	---

Ball Cone Check Valve Male NPT x Female NPT



Size	Brass Part #
1/4"	<b>61-201</b>
3/8"	<b>61-202</b>
1/2"	<b>61-203</b>
3/4"	<b>61-204</b>
1"	<b>61-205</b>
1 1/4"	<b>61-206</b>
1 1/2"	<b>61-207</b>
2"	<b>61-208</b>



## 800 PSI Stainless Steel Check Valves

**Features:**

- soft PTFE seat is spring loaded for fast seating action
- flow profile designed to minimize head loss
- temperature range: **10°F to 450°F (-12°C to 232°C)**
- pressure rating: **800 PSI WOG**; **125 PSI** saturated steam
- cracking pressure: **.5 PSI**
- corrosion resistance, excellent for use on chemicals
- dual guided stem and disc

Female NPT	316 Stainless Steel Part #
1/4"	<b>SSCVIL025</b>
3/8"	<b>SSCVIL038</b>
1/2"	<b>SSCVIL050</b>
3/4"	<b>SSCVIL075</b>
1"	<b>SSCVIL100</b>
1 1/4"	<b>SSCVIL125</b>
1 1/2"	<b>SSCVIL150</b>
2"	<b>SSCVIL200</b>



## Forged Steel Check Valves

**Features:**

- Class 800
- ASTM A105, ANSI B120.1
- bolted bonnet
- pressure rating: **1975 PSI**
- maximum temperature: **800°F (427°C)**
- can be used for steam service

Female NPT	Forged Steel Part #
1/2"	<b>FSCV50</b>
3/4"	<b>FSCV75</b>
1"	<b>FSCV100</b>
1 1/4"	<b>FSCV125</b>
1 1/2"	<b>FSCV150</b>
2"	<b>FSCV200</b>



## Spring-Loaded Check Valves

**Features:**

- cracking pressure: 0.50 PSI
- NBR seat
- soft seat for bubble tight shutoff, spring loaded for fast seating action
- flow profile designed to minimize head loss
- pressure rating :1/2" - 2" **400 PSI WOG**; 3" - 4" **175 PSI WOG**
- temperature range: **10°F to 210°F (-10°C to 100°C)**

Female NPT	Brass Part #
1/2"	<b>CV050</b>
3/4"	<b>CV075</b>
1"	<b>CV100</b>
1 1/4"	<b>CV125</b>
1 1/2"	<b>CV150</b>
2"	<b>CV200</b>
3"	<b>CV300</b>
4"	<b>CV400</b>

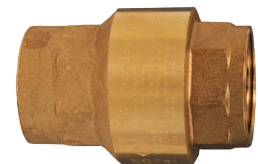

### Strainer with Spring-Loaded Check Valves

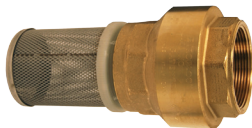

**Features:**

- brass with NBR seat and stainless steel strainer
- soft seat for bubble tight shutoff, spring loaded for fast seating action
- flow profile designed to minimize head loss
- temperature range: **10°F to 210°F (-10°C to 100°C)**
- cracking pressure: **0.50 PSI**
- pressure rating: 1½"-2" **400 PSI WOG**, 3"-4" **175 PSI WOG**

Female NPT	Brass Part #
1½"	<b>BVFS20</b>
2"	<b>BVFS25</b>
3"	<b>BVFS35</b>
4"	<b>BVFS40</b>

### Horizontal Swing Check Valves

**Applications:**

- for use in plumbing and liquid piping systems to prevent back flow

**Features:**

- full flow performance with a minimum of turbulence or pressure loss
- brass disc
- for horizontal or vertical use
- A positive seating disc allows flow only in one direction and a screw-in cap provides easy access for periodic cleaning.
- pressure rating: **200 PSI WOG**
- temperature range: **-20° to 150°F (-29°C to 66°C)**



Female NPT	Brass Part #
½"	<b>SWCV50</b>
¾"	<b>SWCV75</b>
1"	<b>SWCV100</b>
1¼"	<b>SWCV125</b>
1½"	<b>SWCV150</b>
2"	<b>SWCV200</b>
3"	<b>SWCV300</b>
4"	<b>SWCV400</b>

### Domestic Swing Check Valves

**Features:**

- Class 150
- ASME B1.20.1
- metal seat
- 100% factory tested
- working pressure: **300 PSI cold, 150 PSI steam**
- temperature range: **-20°F to 406°F (-29°C to 208°C)**



Female NPT	Brass Part #
½"	<b>DSCV50</b>
¾"	<b>DSCV75</b>
1"	<b>DSCV100</b>
1¼"	<b>DSCV125</b>
1½"	<b>DSCV150</b>
2"	<b>DSCV200</b>

Drum Plug Wrenches

Features:

- sparkproof, natural finish is safe around flammables
- offset handle design reduces user stress and minimizes knuckle injury

Bronze Part #	Aluminum Part #
<b>DPW</b>	<b>ADPW</b>

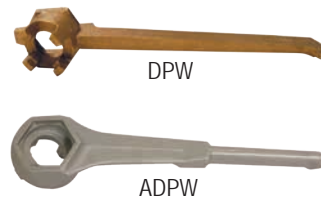

Valves

Drum Faucets  
Polyethylene Drum Faucets

Features:

- Faucets are *not* to be used in applications where temperatures exceed 140°F (60°C).
- no wrench needed for screwing into drum opening
- 2" faucet is shipped with a gasket; the ¾" does not require a gasket

NPT Thread	Gold Polyethylene Part #
¾"	<b>PEDF75</b>
2"	<b>PEDF200</b>



Stainless Heavy Duty Adjustable Drum Faucets

Features:

- ¾" NPT connection
- adjustable shank is designed to easily adjust to proper drain position after installing in drum
- PTFE gasket
- FM approved for use with oils and non-flammables

Stainless Steel Part #
<b>HDSSF75</b>

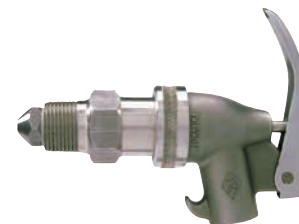

Brass Heavy Duty Adjustable Drum Faucets

Features:

- ¾" NPT connection
- easy to use, self-closing design
- FM approved for use with oils and non-corrosive flammables

Brass Part #
<b>AHDBF75</b>



Brass Heavy Duty Drum Faucet with Rigid Shanks

Features:

- ¾" NPT connection
- easy to use, self-closing design
- PTFE gasket
- FM approved for use with oils and non-corrosive flammables

Brass Part #
<b>HDBF75</b>



Compression Bibb Faucets

Application:

- for water use only

Features:

- rough brass finish
- nozzle end is GHT

Male NPT Inlet	Brass Part #
½"	<b>35-201-10</b>
¾"	<b>35-202-10</b>



Drum Thread Adapters

Valves



**Application:**

- for use in gravity discharge from drums

**Features:**

- male NPSH thread with gasket on the drum side allows for a connection to drums with female NPSH thread
- male NPT end allows for a connection with the female NPT found on most ball valves

Size	Cast Brass Part #
2" x 2"	<b>DMH20DR20</b>

Drum Gate Valves

**Application:**

- ideal for drawing non-flammable liquids from drums and tanks

**Features:**

- iron body
- manually operated
- machined and lapped brass faceplate designed for oval discharge, ensures no splashing and a smooth operation
- black Japanned finish
- can be padlocked



Male NPT	Iron Part #
3/4"	<b>D71</b>
2"	<b>D75</b>

**Features:**

- lightweight, durable aluminum body provides improved corrosion resistance for certain fluids
- sturdy 2" handle is stamped metal with black enamel finish
- can be padlocked



Male NPT	Aluminum Part #
2"	<b>D75AL</b>

Self-Closing Gate Valves

**Application:**

- ideal for dispensing viscous liquids such as oil, grease, paint, varnish and syrups from drums and tanks

**Features:**

- gray iron body, brass sliding gate and machine lapped sealing surface
- gate closes automatically when handle is released, cleaning discharge surface
- can be padlocked



Male NPT	Iron Part #
3/4"	<b>D71SC</b>
2"	<b>D75SC</b>

<b>Sanitary Tube Fittings .....</b>	<b>564 to 630</b>	<b>Sanitary Tube Fittings (cont.) ..</b>	<b>564 to 630</b>
Clamps .....	564 to 566	End caps .....	611
Clamp accessories .....	566	Adapters .....	611
Clamp fittings .....	567 to 576	Tees .....	612
Ferrules .....	567 to 568	Reducers .....	613
Caps .....	569	Type A stub ends .....	613
Adapters .....	569 to 572	Miscellaneous configurations .....	614
Elbows .....	572 to 574	Flanges .....	615
Tees .....	574	Spray balls .....	616
Reducers .....	575	Sight glasses .....	617 to 618
Crosses .....	575	Swivels .....	619
Miscellaneous configurations .....	576	Pressure gauges .....	620
Covers .....	576	Strainers .....	621 to 622
Quick weld ferrules .....	577	Tube hangers .....	623 to 624
Breakaway couplings .....	577	Wall flanges .....	624
Gaskets .....	578 to 583	High purity Biopharm fittings .....	625 to 630
Cam and groove transition .....	584	Elbows .....	625 to 626
Dixon® weld to tube cam and groove .....	584	Tees .....	626 to 627
European fittings .....	585 to 588	Reducers .....	628 to 629
Bevel seat .....	589 to 593	Ferrules .....	630
Nuts .....	589	Caps .....	630
Hex wrenches .....	589		
Ferrules .....	590 to 591	<b>Sanitary Valves .....</b>	<b>631 to 652</b>
End caps .....	591	2-way, 3 piece ball valves .....	631 to 632
Adapters .....	591	Butterfly valves .....	633 to 636
Elbows .....	592	Clamp end .....	633 to 635
Reducers .....	592	B5115 series .....	636
Breakaway couplings .....	592	Spring check valves .....	637
Gaskets .....	593	Y ball check valves .....	638
I-line / Q-line .....	594 to 598	Air blow check valves .....	639
Clamps .....	594	Tank vent valve .....	640 to 642
Ferrules .....	595 to 596	3A sample valves .....	642
End caps .....	596		
Gaskets .....	597 to 598	<b>Actuation: Electric .....</b>	<b>643 to 645</b>
Pipe size .....	599 to 603	2-piece stainless steel ball valves .....	643
Clamps .....	599	3-piece stainless steel ball valves .....	643
Ferrules .....	599 to 600	Brass ball valves .....	644
End caps .....	600	3-way stainless steel ball valves T / L port .....	645
Adapters .....	601	3-way brass ball valves T / L port .....	645
Hangers .....	602		
Gaskets .....	603	<b>Actuation: Pneumatic .....</b>	<b>646 to 652</b>
Polished weld .....	604 to 609	2-piece stainless steel ball valves .....	646
Elbows .....	604 to 606	3-piece stainless ball valves .....	646
Sweep elbows .....	606	Brass ball valves .....	647
Tees .....	607	3-way brass ball valves T / L port .....	648 to 649
Adapters .....	608	Wafer butterfly valves .....	650
Reducers .....	608	Lug butterfly valves .....	650
Crosses .....	609	Flow paths .....	651
Miscellaneous configurations .....	609	Accessories .....	652
Protection covers .....	610	Limit switches .....	652
Unpolished weld .....	610 to 614	Solenoids .....	652
Elbows .....	610 to 611	Positioners .....	652

Clamps

Service pressure ratings are based on the following parameters: matching elastomer gaskets and weld ferrules properly aligned and assembled with the clamps tightened to the required torque (25 in. lbs.). Tests are done hydrostatically with no water hammer or shock loads. Please note the pressure ratings of the described unions are above the recommended pipe line operating pressures. 

Dimensions are approximate. Engineering dimensions are available upon request. Specifications are subject to change without notice.

Sanitary Fittings

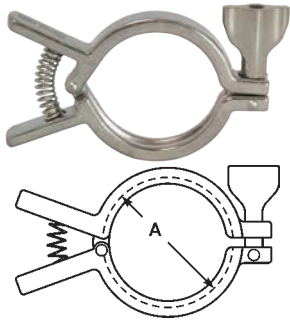

Single Pin Squeeze - 13MHHM-Q

Tube OD	Service Pressure PSI Rating @ 70°F (21°C) <sup>1</sup>	Service Pressure PSI Rating @ 250°F (121°C) <sup>1</sup>	Dimension A	Stainless Steel Part #
½" - ¾"	1500	1200	1.062"	13MHHM-Q75
1" - 1½"	500	300	2.122"	13MHHM-Q100150
2"	450	250	2.654"	13MHHM-Q200
2½"	400	200	3.185"	13MHHM-Q250
3"	350	175	3.717"	13MHHM-Q300
4"	300	150	4.820"	13MHHM-Q400

Single Pin Heavy Duty - 13MHHM  
with cross hole wing nut

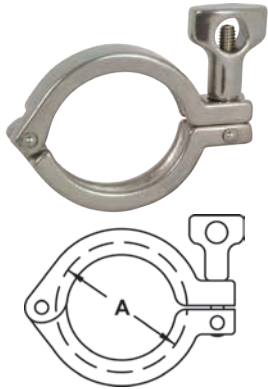

Tube OD	Service Pressure PSI Rating @ 70°F (21°C) <sup>1</sup>	Service Pressure PSI Rating @ 250°F (121°C) <sup>1</sup>	Dimension A	Stainless Steel Part #
½" - ¾"	1500	1200	1.062"	13MHHM50-75
1" - 1½"	500	300	2.122"	13MHHM100-150
2"	450	250	2.654"	13MHHM200
2½"	400	200	3.185"	13MHHM250
3"	350	175	3.717"	13MHHM300
4"	300	150	4.820"	13MHHM400
5"	225	100	5.820"	13MHHM500
6"	150	75	6.695"	13MHHM600
8"	100	50	8.695"	13MHHM800

Single Pin Heavy Duty - 13MHHM\*\*\*SN  
with serrated wing nut

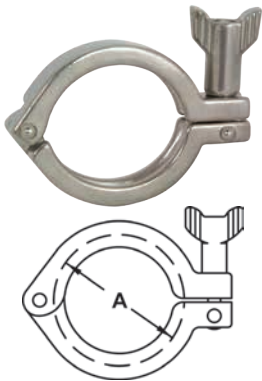

Tube OD	Service Pressure PSI Rating @ 70°F (21°C) <sup>1</sup>	Service Pressure PSI Rating @ 250°F (121°C) <sup>1</sup>	Dimension A	Stainless Steel Part #
½" - ¾"	1500	1200	1.062"	13MHHM50-75SN
1" - 1½"	500	300	2.122"	13MHHM100-150SN
2"	450	250	2.654"	13MHHM200SN
2½"	400	200	3.185"	13MHHM250SN
3"	350	175	3.717"	13MHHM300SN
4"	300	150	4.820"	13MHHM400SN
5"	225	100	5.820"	13MHHM500SN
6"	150	75	6.695"	13MHHM600SN
8"	100	50	8.695"	13MHHM800SN

Double Pin Heavy Duty - 13MHHM-DP

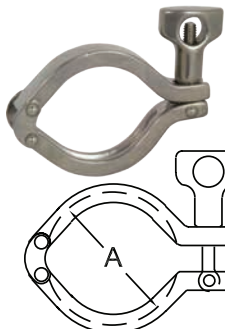

Tube OD	Service Pressure PSI Rating @ 70°F (21°C) <sup>1</sup>	Service Pressure PSI Rating @ 250°F (121°C) <sup>1</sup>	Dimension A	Stainless Steel Part #
1" - 1½"	500	300	2.122"	13MHHM-DP100150
2"	450	250	2.654"	13MHHM-DP200
2½"	400	200	3.185"	13MHHM-DP250
3"	350	175	3.717"	13MHHM-DP300
4"	300	150	4.820"	13MHHM-DP400
10"	100	50	10.740"	13MHHM-DP1000

<sup>1</sup> wing nut tightened to 25 in. lb. of torque

## Clamps

## Three Segment - 13MHHM-3P

Tube OD	Service Pressure PSI Rating @ 70°F (21°C) <sup>1</sup>	Service Pressure PSI Rating @ 250°F (121°C) <sup>1</sup>	Dimension A	Stainless Steel Part #
1" - 1½"	<b>600</b>	<b>300</b>	2.122"	<b>13MHHM-3P100150</b>
2"	<b>550</b>	<b>275</b>	2.654"	<b>13MHHM-3P200</b>
2½"	<b>450</b>	<b>225</b>	3.185"	<b>13MHHM-3P250</b>
3"	<b>350</b>	<b>175</b>	3.717"	<b>13MHHM-3P300</b>
4"	<b>300</b>	<b>150</b>	4.820"	<b>13MHHM-3P400</b>
12"	<b>75</b>	<b>50</b>	12.740"	<b>13MHHM-3P1200</b>

<sup>1</sup> wing nut tightened to 25 in. lb. of torque

Sanitary  
Fittings

## Bolted - 13MHP

Tube OD	Service Pressure PSI Rating @ 70°F (21°C) <sup>1</sup>	Service Pressure PSI Rating @ 250°F (121°C) <sup>1</sup>	Dimension A	Stainless Steel Part #
½" - ¾"	<b>1500</b>	<b>1200</b>	1.062"	<b>13MHP75</b>
1" - 1½"	<b>1500</b>	<b>1200</b>	2.046"	<b>13MHP100-150</b>
2"	<b>1000</b>	<b>800</b>	2.578"	<b>13MHP200</b>
2½"	<b>1000</b>	<b>800</b>	3.110"	<b>13MHP250</b>
3"	<b>1000</b>	<b>800</b>	3.640"	<b>13MHP300</b>
4"	<b>800</b>	<b>600</b>	4.744"	<b>13MHP400</b>
6"	<b>300</b>	<b>200</b>	6.632"	<b>13MHP600</b>
8"	<b>250</b>	<b>150</b>	8.638"	<b>13MHP800</b>
10"	<b>200</b>	<b>125</b>	10.740"	<b>13MHP1000</b>
12"	<b>150</b>	<b>100</b>	12.740"	<b>13MHP1200</b>

<sup>1</sup> all nuts are tightened to 20 ft. lbs. of torque

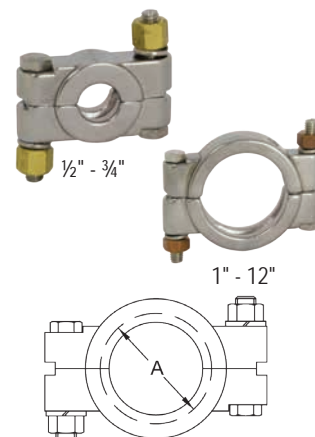

## Toggle - 13MHLA

Tube OD	Service Pressure PSI Rating @ 70°F (21°C) <sup>1</sup>	Service Pressure PSI Rating @ 250°F (121°C) <sup>1</sup>	Dimension A	304 Stainless Steel Part #
1" - 1½"	<b>150</b>	<b>125</b>	2.122"	<b>13MHLA100-150</b>
2"	<b>150</b>	<b>125</b>	2.654"	<b>13MHLA200</b>
2½"	<b>150</b>	<b>125</b>	3.185"	<b>13MHLA250</b>
3"	<b>150</b>	<b>125</b>	3.717"	<b>13MHLA300</b>
4"	<b>100</b>	<b>75</b>	4.820"	<b>13MHLA400</b>

<sup>1</sup> screw tightened to maximum



## T-bolt - 13MO

Tube OD	Service Pressure PSI Rating @ 70°F (21°C) <sup>1</sup>	Service Pressure PSI Rating @ 250°F (121°C) <sup>1</sup>	Dimension A	304 Stainless Steel Part #
1" - 1½"	<b>500</b>	<b>250</b>	2.080"	<b>13MO100-150</b>
2"	<b>350</b>	<b>200</b>	2.610"	<b>13MO200</b>
2½"	<b>300</b>	<b>150</b>	3.140"	<b>13MO250</b>
3"	<b>200</b>	<b>100</b>	3.670"	<b>13MO300</b>
4"	<b>100</b>	<b>75</b>	4.780"	<b>13MO400</b>
6"	<b>75</b>	<b>50</b>	6.690"	<b>13MO600</b>
8" <sup>2</sup>	<b>50</b>	<b>40</b>	8.690"	<b>13MO800</b>
10" <sup>2</sup>	<b>40</b>	<b>30</b>	10.690"	<b>13MO1000</b>
12" <sup>2</sup>	<b>30</b>	<b>25</b>	12.690"	<b>13MO1200</b>

<sup>1</sup> 1" - 3" nuts tightened to 20 in. lb., 4" nut tightened to 30 in. lb., 6" nut tightened to 40 in. lb. and 8" - 12" nuts tightened to 50 in. lb. of torque

<sup>2</sup> 2 bolt configuration



Clamps

Dairy - 13WGC



Tube OD	Service Pressure PSI Rating @ 70°F (21°C) <sup>1</sup>	Service Pressure PSI Rating @ 250°F (121°C) <sup>1</sup>	Dimension A	304 Stainless Steel Part #
1" - 1½"	100	75	2.08"	13WGC100-150
2"	100	75	2.61"	13WGC200
2½"	100	75	3.14"	13WGC250
3"	100	75	3.67"	13WGC300
4"	100	75	4.78"	13WGC400

<sup>1</sup> finger tight

Accessories

Spring Loaded Nut - 13SLN

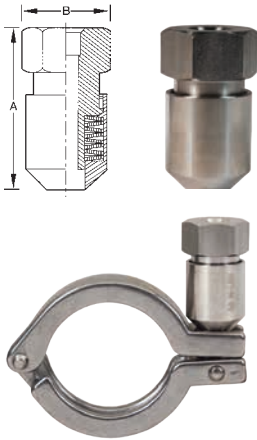

Features:

- Lines using PTFE gaskets that are subject to large temperature swings can benefit from this special product. As the PTFE is compressed through the cycling of the lines, the spring loaded will help keep the connection from leaking.
- If the lines suffer from vibration and bolted clamps are not an option, refitting single pin clamps with this nut will keep the connections from leaking for a longer time than the standard wing nuts.
- If you transport material in tanks via truck, the vibrations can loosen the standard single pin clamps - spring loaded nuts can add a level of insurance to the shipment.
- note: can be used on all wing nut style clamps.
- torque to 50 in. lb.

Thread	Dimension A	Dimension B	304 Stainless Steel Part #
5/16" - 18	1.73"	.875"	13SLN

Nuts and Bolts



Description	Part Number
cross hole wing nut 5/16"-18	13WNX
mini cross hole wing nut 5/16"-18 for ½" - ¾" clamps	13WNXM
serrated wing nut 5/16"-18	13WNS
hex wing nut 5/16"-18	13WNH
bronze hex nut ¾"-16 for bolted clamps	13BN
brass 3/8-16 nuts used on ½" - ¾" and 10" & 12" bolted clamps	13BNH
stainless steel hex nut for bolted clamps	13SN
¾" 304 stainless steel lock washer	13LW
bolt ¾"-16 x 2¼" for ½" - 1½" bolted clamps	13CB-2.25
bolt ¾"-16 x 2¾" for 2" and 2½" bolted clamps	13CB-2.75
bolt ¾"-16 x 3¼" for 3" - 12" bolted clamps	13CB-3.25
rivet pin for ½" - 5" single pin clamps 5/16" x 1"	13RP
rivet pin for 6" and 8" single pin clamps 5/16" x 1½"	13RP6
5/16"-18 x 2" threaded eye bolt for ½" - 5" clamps	13IB
5/16"-18 x 2½" threaded eye bolt for 6" - 12" clamps	13IB6



Clamp Fittings - Ferrules

Short Weld - 14WMP



Tube OD	Dimensions			304 Stainless Steel Part #	316L Stainless Steel Part #
	A	B	C		
½"	.500"	.370"	.500"	<b>14WMP-G50</b>	<b>14WMP-R50</b>
¾"	.500"	.620"	.750"	<b>14WMP-G75</b>	<b>14WMP-R75</b>
1"	.500"	.870"	1.000"	<b>14WMP-G100</b>	<b>14WMP-R100</b>
1½"	.500"	1.370"	1.500"	<b>14WMP-G150</b>	<b>14WMP-R150</b>
2"	.500"	1.870"	2.000"	<b>14WMP-G200</b>	<b>14WMP-R200</b>
2½"	.500"	2.370"	2.500"	<b>14WMP-G250</b>	<b>14WMP-R250</b>
3"	.500"	2.870"	3.000"	<b>14WMP-G300</b>	<b>14WMP-R300</b>
4"	.625"	3.834"	4.000"	<b>14WMP-G400</b>	<b>14WMP-R400</b>
5"	.750"	4.782"	5.000"	<b>14WMP-G500</b>	<b>14WMP-R500</b>
6"	.875"	5.782"	6.000"	<b>14WMP-G600</b>	<b>14WMP-R600</b>
8"	.875"	7.782"	8.000"	<b>14WMP-G800</b>	<b>14WMP-R800</b>
10"	.875"	9.760"	10.000"	<b>14WMP-G1000</b>	<b>14WMP-R1000</b>
12"	.875"	11.760"	12.000"	<b>14WMP-G1200</b>	<b>14WMP-R1200</b>

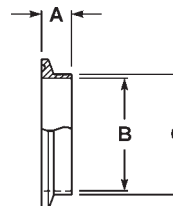

Sanitary Fittings

Long Weld - L14AM7



Tube OD	Dimensions			304 Stainless Steel Part #	316L Stainless Steel Part #
	A	B	C		
½"	1.125"	.370"	.500"	<b>L14AM7-G50</b>	<b>L14AM7-R50</b>
¾"	1.125"	.620"	.750"	<b>L14AM7-G75</b>	<b>L14AM7-R75</b>
1"	1.125"	.870"	1.000"	<b>L14AM7-G100</b>	<b>L14AM7-R100</b>
1½"	1.125"	1.370"	1.500"	<b>L14AM7-G150</b>	<b>L14AM7-R150</b>
2"	1.125"	1.870"	2.000"	<b>L14AM7-G200</b>	<b>L14AM7-R200</b>
2½"	1.125"	2.370"	2.500"	<b>L14AM7-G250</b>	<b>L14AM7-R250</b>
3"	1.125"	2.870"	3.000"	<b>L14AM7-G300</b>	<b>L14AM7-R300</b>
4"	1.125"	3.834"	4.000"	<b>L14AM7-G400</b>	<b>L14AM7-R400</b>
5"	1.125"	4.782"	5.000"	<b>L14AM7-G500</b>	<b>L14AM7-R500</b>
6"	1.500"	5.782"	6.000"	<b>L14AM7-G600</b>	<b>L14AM7-R600</b>
8"	1.500"	7.782"	8.000"	<b>L14AM7-G800</b>	<b>L14AM7-R800</b>
10"	1.750"	9.760"	10.000"	<b>L14AM7-G1000</b>	<b>L14AM7-R1000</b>
12"	1.750"	11.760"	12.000"	<b>L14AM7-G1200</b>	<b>L14AM7-R1200</b>

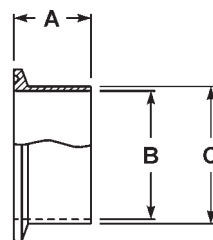

NEW

NEW

Automatic Weld - TL14AM7



Specification:

- meets ASME BPE-2012 specifications

Tube OD	Dimensions			316L Stainless Steel Part #
	A	B	C	
½"	1.750"	.370"	.500"	<b>TL14AM7-050PL</b>
¾"	1.750"	.620"	.750"	<b>TL14AM7-075PL</b>
1"	1.750"	.870"	1.000"	<b>TL14AM7-100PL</b>
1½"	1.750"	1.370"	1.500"	<b>TL14AM7-150PL</b>
2"	2.250"	1.870"	2.000"	<b>TL14AM7-200PL</b>
3"	2.250"	2.870"	3.000"	<b>TL14AM7-300PL</b>
4"	2.250"	3.834"	4.000"	<b>TL14AM7-400PL</b>

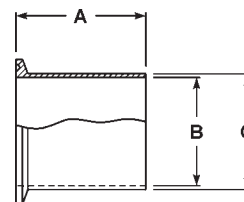
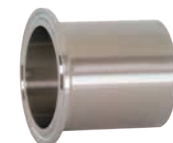

Tank (light duty) - 14WLMP



Tube OD	Dimensions			304 Stainless Steel Part #	316L Stainless Steel Part #
	A	B	C		
1"	3.000"	.870"	1.000"	<b>14WLMP-G100</b>	<b>14WLMP-R100</b>
1½"	3.000"	1.370"	1.500"	<b>14WLMP-G150</b>	<b>14WLMP-R150</b>
2"	3.000"	1.870"	2.000"	<b>14WLMP-G200</b>	<b>14WLMP-R200</b>
2½"	3.000"	2.370"	2.500"	<b>14WLMP-G250</b>	<b>14WLMP-R250</b>
3"	4.000"	2.870"	3.000"	<b>14WLMP-G300</b>	<b>14WLMP-R300</b>
4"	4.000"	3.834"	4.000"	<b>14WLMP-G400</b>	<b>14WLMP-R400</b>
6"	6.000"	5.782"	6.000"	<b>14WLMP-G600</b>	<b>14WLMP-R600</b>

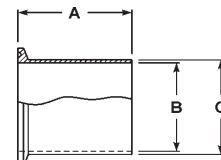

Clamp Fittings - Ferrules

Sanitary Fittings

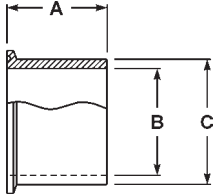

Tank (heavy duty) - 14MPW

Specification:

- certified ASME materials

Tube OD	Dimensions			316L Stainless Steel Part #
	A	B	C	
½"	1.625"	.321"	.502"	<b>14MPW-R50</b>
¾"	1.625"	.574"	.750"	<b>14MPW-R75</b>
1"	1.625"	.870"	1.160"	<b>14MPW-R100</b>
1½"	1.625"	1.370"	1.676"	<b>14MPW-R150</b>
2"	1.750"	1.870"	2.192"	<b>14MPW-R200</b>
2½"	1.750"	2.370"	2.708"	<b>14MPW-R250</b>
3"	1.813"	2.870"	3.224"	<b>14MPW-R300</b>
4"	2.125"	3.834"	4.256"	<b>14MPW-R400</b>
6"	2.500"	5.758"	6.192"	<b>14MPW-R600</b>

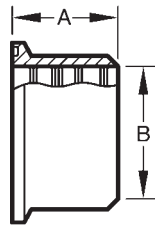

Roll-on for Expanding - 14RMP

Tube OD	Dimensions		304 Stainless Steel Part #	316L Stainless Steel Part #
	A	B		
1"	.750"	1.005"	<b>14RMP-G100</b>	<b>14RMP-R100</b>
1½"	1.125"	1.505"	<b>14RMP-G150</b>	<b>14RMP-R150</b>
2"	1.312"	2.005"	<b>14RMP-G200</b>	<b>14RMP-R200</b>
2½"	1.375"	2.505"	<b>14RMP-G250</b>	<b>14RMP-R250</b>
3"	1.437"	3.005"	<b>14RMP-G300</b>	<b>14RMP-R300</b>
4"	1.500"	4.005"	<b>14RMP-G400</b>	<b>14RMP-R400</b>

<sup>1</sup> Meets 3-A Standard Number 63-03 when used to modify or repair existing on-site farm milk handling systems.

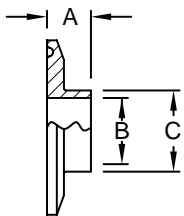

Reducing - B31WMP

Tube OD	Dimensions			304 Stainless Steel Part #	316L Stainless Steel Part #
	A	B	C		
2" x 1"	.500"	.870"	1.000"	<b>B31WMP-G200100</b>	<b>B31WMP-R200100</b>
2½" x 1½"	.500"	1.370"	1.500"	<b>B31WMP-G250150</b>	<b>B31WMP-R250150</b>
2½" x 2"	.500"	1.870"	2.000"	<b>B31WMP-G250200</b>	<b>B31WMP-R250200</b>
3" x 2"	.500"	1.870"	2.000"	<b>B31WMP-G300200</b>	<b>B31WMP-R300200</b>
4" x 3"	.625"	2.870"	3.000"	<b>B31WMP-G400300</b>	<b>B31WMP-R400300</b>

## Clamp Fittings - Caps

## Solid End - 16AMP



- Specify if you are using a piping system or a tubing system when ordering.

Tube OD	Dimensions		304 Stainless Steel Part #	316L Stainless Steel Part #
	A	B		
½" - ¾"	.187"	.992"	<b>16AMP-G50-75</b>	<b>16AMP-R50-75</b>
1" - 1½"	.250"	1.984"	<b>16AMP-G100-150</b>	<b>16AMP-R100-150</b>
2"	.250"	2.516"	<b>16AMP-G200</b>	<b>16AMP-R200</b>
2½"	.250"	3.047"	<b>16AMP-G250</b>	<b>16AMP-R250</b>
3"	.250"	3.579"	<b>16AMP-G300</b>	<b>16AMP-R300</b>
4"	.312"	4.682"	<b>16AMP-G400</b>	<b>16AMP-R400</b>
5"	.376"	5.687"	<b>16AMP-G500</b>	<b>16AMP-R500</b>
6"	.437"	6.570"	<b>16AMP-G600</b>	<b>16AMP-R600</b>
8"	.437"	8.570"	<b>16AMP-G800</b>	<b>16AMP-R800</b>
10"	.437"	10.570"	<b>16AMP-G1000</b>	<b>16AMP-R1000</b>
12"	.437"	12.750"	<b>16AMP-G1200</b>	<b>16AMP-R1200</b>



Sanitary Fittings

## Thermometer - B23BMP

Tube OD	Dimensions			304 Stainless Steel Part #	316L Stainless Steel Part #
	A	B	C <sup>1</sup>		
½"	.500"	.992"	¼" NPT	---	<b>B23BMP-R5014</b>
¾"	.500"	.992"	¼" NPT	---	<b>B23BMP-R7514</b>
1"	.625"	1.984"	½" NPT	<b>B23BMP-G100</b>	<b>B23BMP-R100</b>
1½"	.625"	1.984"	¾" NPT	<b>B23BMP-G150</b>	<b>B23BMP-R150</b>
2"	.625"	2.516"	¾" NPT	<b>B23BMP-G200</b>	<b>B23BMP-R200</b>
2½"	.625"	3.047"	¾" NPT	<b>B23BMP-G250</b>	<b>B23BMP-R250</b>
3"	.625"	3.579"	¾" NPT	<b>B23BMP-G300</b>	<b>B23BMP-R300</b>
4"	.625"	4.682"	¾" NPT	<b>B23BMP-G400</b>	<b>B23BMP-R400</b>

<sup>1</sup> other NPT tap sizes available, contact Dixon®

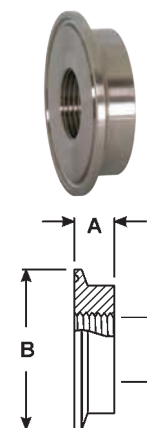

## Clamp Fittings - Adapters

## Tygon® Hose - 14MPHT

Tube OD	Dimensions			316L Stainless Steel Part #
	A	B	C	
¾"	4.000"	.620"	.750"	<b>14MPHT-R75</b>
1"	4.500"	.870"	1.000"	<b>14MPHT-R100</b>
1½"	4.500"	1.370"	1.500"	<b>14MPHT-R150</b>
2"	4.500"	1.870"	2.000"	<b>14MPHT-R200</b>
2½"	4.500"	2.370"	2.500"	<b>14MPHT-R250</b>
3"	4.500"	2.870"	3.000"	<b>14MPHT-R300</b>
4"	4.625"	3.834"	4.000"	<b>14MPHT-R400</b>

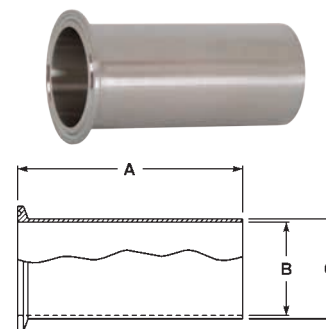

Clamp Fittings - Adapters

Rubber Hose - 14MPHR

Sanitary Fittings

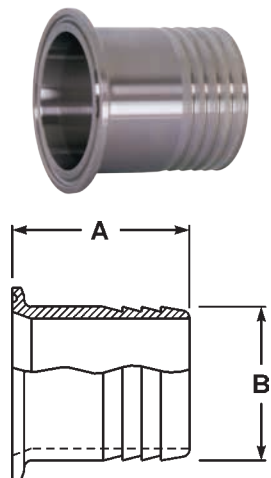

Tube OD	Hose Size	Dimensions		304 Stainless Steel Part #	316L Stainless Steel Part #
		A	B		
1/2"	1/4"	1.500"	.290"	---	14MPHR-R5025
	1/2"	1.500"	.540"	---	14MPHR-R50
	3/4"	1.500"	.790"	---	14MPHR-R5075
3/4"	1/4"	1.500"	.290"	---	14MPHR-R7525
	3/8"	1.500"	.415"	---	14MPHR-R75375
	1/2"	1.500"	.540"	---	14MPHR-R7550
1"	3/4"	1.500"	.790"	---	14MPHR-R75
	1"	1.688"	1.040"	---	14MPHR-R100375
	1 1/2"	1.688"	1.540"	---	14MPHR-R10050
1 1/2"	1/2"	1.500"	.540"	---	14MPHR-R10075
	5/8"	1.500"	.665"	---	14MPHR-R10075
	3/4"	1.500"	.790"	---	14MPHR-R100
	1"	1.687"	1.040"	---	14MPHR-R150375
2"	1 1/2"	1.687"	1.540"	---	14MPHR-R15050
	1 1/2"	1.687"	1.540"	---	14MPHR-R150625
	1 1/2"	1.687"	1.540"	---	14MPHR-R15075
	1 1/2"	1.687"	1.540"	---	14MPHR-R150100
2 1/2"	1 1/2"	2.312"	1.540"	---	14MPHR-R150100
	2"	2.312"	2.040"	---	14MPHR-R150
2 1/2"	2 1/2"	2.344"	2.540"	---	14MPHR-R200150
3"	3"	3.094"	3.040"	---	14MPHR-R200
4"	4"	3.406"	4.040"	---	14MPHR-R250
6"	6"	3.406"	6.040"	---	14MPHR-R300
				---	14MPHR-R400
				---	14MPHR-R600

Brewery Hose Barb - 14MPHRL

Feature:

- suitable for use with band clamps

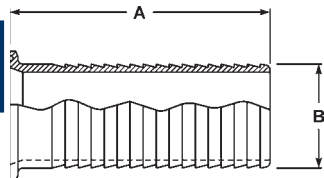

Tube OD	Dimensions		304 Stainless Steel Part #
	A	B	
1"	3.500"	1.045"	14MPHRL100
1 1/2"	5.000"	1.545"	14MPHRL150
2"	5.000"	2.045"	14MPHRL200
2 1/2"	5.500"	2.545"	14MPHRL250
3"	5.500"	3.045"	14MPHRL300
4"	5.500"	4.045"	14MPHRL400

Use of PVC tubing requires special installation techniques to prevent leakage. All assembly work must be done with heated tube. Cold durometer is 90 as opposed to rubber hose at 65 to 70 durometer. Banding buckles must be at 180° from one another. 

## Clamp Fittings - Adapters

## Male NPT - 21MP

Tube OD	NPT Size	Dimensions		304 Stainless Steel Part #	316L Stainless Steel Part #
		A	B		
½"	¼"	2.000"	.595"	---	<b>21MP-R5025</b>
	⅜"	2.000"	.600"	---	<b>21MP-R50375</b>
	½"	1.625"	.782"	---	<b>21MP-R50</b>
	¾"	2.000"	.794"	---	<b>21MP-R5075</b>
¾"	¼"	2.000"	.595"	---	<b>21MP-R7525</b>
	⅜"	2.000"	.600"	---	<b>21MP-R75375</b>
	½"	2.000"	.782"	---	<b>21MP-R7550</b>
	¾"	1.787"	.794"	---	<b>21MP-R75</b>
1"	½"	2.187"	.782"	<b>21MP-G10050</b>	<b>21MP-R10050</b>
	¾"	2.187"	.794"	<b>21MP-G10075</b>	<b>21MP-R10075</b>
	1"	2.250"	.985"	<b>21MP-G100</b>	<b>21MP-R100</b>
	1¼"	2.438"	1.009"	<b>21MP-G100125</b>	<b>21MP-R100125</b>
	1½"	2.438"	1.025"	<b>21MP-G100150</b>	<b>21MP-R100150</b>
	2"	2.625"	1.058"	<b>21MP-G100200</b>	<b>21MP-R100200</b>
1½"	⅜"	2.161"	.600"	<b>21MP-G150375</b>	<b>21MP-R150375</b>
	½"	2.187"	.782"	<b>21MP-G15050</b>	<b>21MP-R15050</b>
	¾"	2.187"	.794"	<b>21MP-G15075</b>	<b>21MP-R15075</b>
	1"	2.437"	.985"	<b>21MP-G150100</b>	<b>21MP-R150100</b>
	1¼"	2.438"	1.009"	<b>21MP-G150125</b>	<b>21MP-R150125</b>
	1½"	2.250"	1.025"	<b>21MP-G150</b>	<b>21MP-R150</b>
	2"	2.625"	1.058"	<b>21MP-G150200</b>	<b>21MP-R150200</b>
	2"	2.625"	1.058"	<b>21MP-G150200</b>	<b>21MP-R150200</b>
2"	½"	2.188"	.782"	<b>21MP-G20050</b>	<b>21MP-R20050</b>
	¾"	2.188"	.794"	<b>21MP-G20075</b>	<b>21MP-R20075</b>
	1"	2.469"	.985"	<b>21MP-G200100</b>	<b>21MP-R200100</b>
	1½"	2.625"	1.009"	<b>21MP-G200150</b>	<b>21MP-R200150</b>
	2"	2.638"	1.058"	<b>21MP-G200</b>	<b>21MP-R200</b>
2½"	½"	2.781"	.782"	<b>21MP-G25050</b>	---
	1"	2.781"	.782"	<b>21MP-G250100</b>	<b>21MP-R250100</b>
	1½"	2.781"	1.025"	<b>21MP-G250150</b>	<b>21MP-R250150</b>
	2"	2.781"	1.058"	<b>21MP-G250200</b>	<b>21MP-R250200</b>
	2½"	2.875"	1.571"	<b>21MP-G250</b>	<b>21MP-R250</b>
3"	1½"	3.000"	1.009"	<b>21MP-G300150</b>	<b>21MP-R300150</b>
	2"	3.000"	1.058"	<b>21MP-G300200</b>	<b>21MP-R300200</b>
	3"	3.070"	1.634"	<b>21MP-G300</b>	<b>21MP-R300</b>
4"	4"	3.155"	1.734"	<b>21MP-G400</b>	<b>21MP-R400</b>

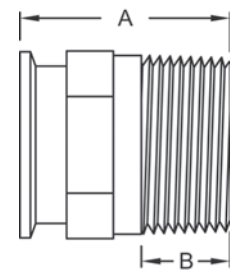

Clamp Fittings - Adapters

Female NPT - 22MP

Sanitary Fittings

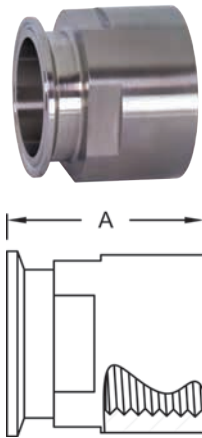

Tube OD	NPT Size	Dimension A	304 Stainless Steel Part #	316L Stainless Steel Part #
1/2"	1/4"	1.500"	---	<b>22MP-R5025</b>
	3/8"	1.500"	---	<b>22MP-R50375</b>
	1/2"	1.500"	---	<b>22MP-R50</b>
	3/4"	1.625"	---	<b>22MP-R5075</b>
3/4"	1/4"	1.500"	---	<b>22MP-R7525</b>
	1/2"	1.500"	---	<b>22MP-R7550</b>
	3/4"	1.625"	---	<b>22MP-R75</b>
1"	1/4"	1.625"	---	<b>22MP-R10025</b>
	1/2"	1.625"	<b>22MP-G10050</b>	<b>22MP-R10050</b>
	3/4"	1.625"	<b>22MP-G10075</b>	<b>22MP-R10075</b>
	1"	1.625"	<b>22MP-G100</b>	<b>22MP-R100</b>
	1 1/4"	1.625"	---	<b>22MP-R100125</b>
1 1/2"	1/2"	1.625"	<b>22MP-G15050</b>	<b>22MP-R15050</b>
	3/4"	1.625"	<b>22MP-G15075</b>	<b>22MP-R15075</b>
	1"	1.625"	<b>22MP-G150100</b>	<b>22MP-R150100</b>
	1 1/2"	2.250"	<b>22MP-G150</b>	<b>22MP-R150</b>
	2"	2.250"	<b>22MP-G150200</b>	<b>22MP-R150200</b>
2"	1"	1.687"	<b>22MP-G200100</b>	<b>22MP-R200100</b>
	1 1/2"	1.656"	<b>22MP-G200150</b>	<b>22MP-R200150</b>
	2"	2.344"	<b>22MP-G200</b>	<b>22MP-R200</b>
	2 1/2"	2.406"	<b>22MP-G200250</b>	---
2 1/2"	2"	1.720"	<b>22MP-G250200</b>	<b>22MP-R250200</b>
	2 1/2"	2.097"	<b>22MP-G250</b>	<b>22MP-R250</b>
3"	2"	2.187"	<b>22MP-G300200</b>	<b>22MP-R300200</b>
	2 1/2"	2.187"	<b>22MP-G300250</b>	---
	3"	2.187"	<b>22MP-G300</b>	<b>22MP-R300</b>
4"	4"	3.000"	<b>22MP-G400</b>	<b>22MP-R400</b>

Visit [dixonvalve.com](http://dixonvalve.com) for pipe thread data



Clamp Fittings - Elbows

90° - B2CMP

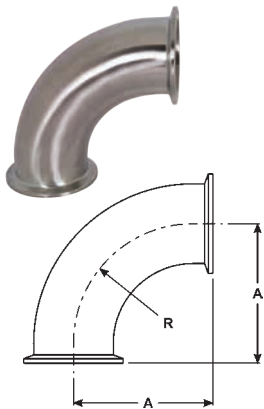

Tube OD	Dimensions		304 Stainless Steel Part #	316L Stainless Steel Part #
	A	R		
1/2"	1.625"	1.125"	---	<b>B2CMP-R50</b>
3/4"	1.625"	1.125"	---	<b>B2CMP-R75</b>
1"	2.000"	1.500"	<b>B2CMP-G100</b>	<b>B2CMP-R100</b>
1 1/2"	2.750"	2.250"	<b>B2CMP-G150</b>	<b>B2CMP-R150</b>
2"	3.500"	3.000"	<b>B2CMP-G200</b>	<b>B2CMP-R200</b>
2 1/2"	4.250"	3.750"	<b>B2CMP-G250</b>	<b>B2CMP-R250</b>
3"	5.000"	4.500"	<b>B2CMP-G300</b>	<b>B2CMP-R300</b>
4"	6.625"	6.000"	<b>B2CMP-G400</b>	<b>B2CMP-R400</b>
6"	9.875"	9.000"	<b>B2CMP-G600</b>	<b>B2CMP-R600</b>

Clamp Fittings - Elbows

45° - B2KMP



Tube OD	Dimensions		304 Stainless Steel Part #	316L Stainless Steel Part #
	A	R		
1/2"	.97"	1.125"	---	<b>B2KMP-R50</b>
3/4"	.97"	1.125"	---	<b>B2KMP-R75</b>
1"	1.12"	1.500"	<b>B2KMP-G100</b>	<b>B2KMP-R100</b>
1 1/2"	1.43"	2.250"	<b>B2KMP-G150</b>	<b>B2KMP-R150</b>
2"	1.74"	3.000"	<b>B2KMP-G200</b>	<b>B2KMP-R200</b>
2 1/2"	2.05"	3.750"	<b>B2KMP-G250</b>	<b>B2KMP-R250</b>
3"	2.36"	4.500"	<b>B2KMP-G300</b>	<b>B2KMP-R300</b>
4"	3.11"	6.000"	<b>B2KMP-G400</b>	<b>B2KMP-R400</b>
6"	4.60"	9.000"	<b>B2KMP-G600</b>	<b>B2KMP-R600</b>

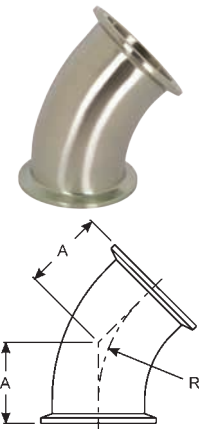

Sanitary Fittings

90° x Plain Bevel Seat with Hex Nut - B2FMP-14



Tube OD	Dimensions		304 Stainless Steel Part #
	A	B	
2"	3.750"	3.500"	<b>B2FMP-14-G200</b>
2 1/2"	4.625"	4.250"	<b>B2FMP-14-G250</b>
3"	5.406"	5.000"	<b>B2FMP-14-G300</b>



Clamp Fittings - Tees

Short Outlet - B7MPS

Sanitary Fittings

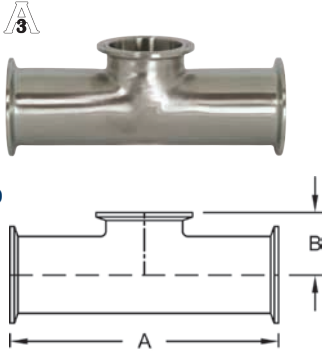

Tube OD	A	B	304 Stainless Steel Part Number	316L Stainless Steel Part Number
1½"	5.500"	1.375"	<b>B7MPS-G150</b>	<b>B7MPS-R150</b>
2"	7.000"	1.625"	<b>B7MPS-G200</b>	<b>B7MPS-R200</b>
2½"	7.000"	1.875"	<b>B7MPS-G250</b>	<b>B7MPS-R250</b>



Clamp Tees - B7MP

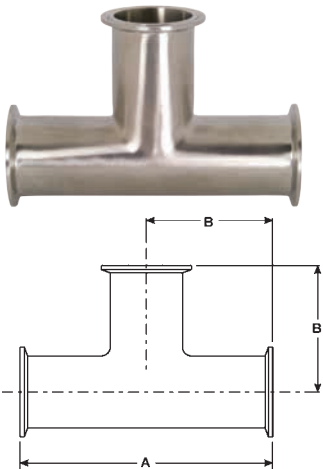

Tube OD	Dimensions		304 Stainless Steel Part #	316L Stainless Steel Part #
	A	B		
½"	4.750"	2.375"	---	<b>B7MP-R50</b>
¾"	5.000"	2.500"	---	<b>B7MP-R75</b>
1"	4.750"	2.375"	<b>B7MP-G100</b>	<b>B7MP-R100</b>
1½"	5.500"	2.750"	<b>B7MP-G150</b>	<b>B7MP-R150</b>
2"	7.000"	3.500"	<b>B7MP-G200</b>	<b>B7MP-R200</b>
2½"	7.000"	3.500"	<b>B7MP-G250</b>	<b>B7MP-R250</b>
3"	7.500"	3.750"	<b>B7MP-G300</b>	<b>B7MP-R300</b>
4"	9.000"	4.500"	<b>B7MP-G400</b>	<b>B7MP-R400</b>
6"	13.000"	6.500"	<b>B7MP-G600</b>	<b>B7MP-R600</b>
8"	15.750"	7.875"	<b>B7MP-G800</b>	<b>B7MP-R800</b>



Reducing - B7RMP

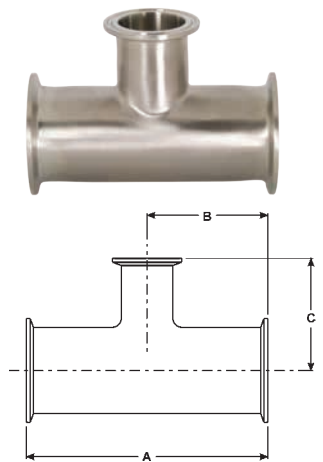

Tube OD	Dimensions			304 Stainless Steel Part #	316L Stainless Steel Part #
	A	B	C		
1" x ¾"	5.250"	2.625"	2.625"	---	<b>B7RMP-R10075</b>
1½" x ½"	5.750"	2.875"	2.875"	---	<b>B7RMP-R15050</b>
1½" x 1"	4.312"	2.156"	1.875"	---	<b>B7RMP-R150100</b>
2" x ½"	6.750"	3.375"	3.125"	---	<b>B7RMP-R20050</b>
2" x ¾"	6.750"	3.375"	3.125"	---	<b>B7RMP-R20075</b>
2" x 1"	5.125"	2.562"	2.125"	<b>B7RMP-G200100</b>	<b>B7RMP-R200100</b>
2" x 1½"	5.125"	2.562"	2.406"	<b>B7RMP-G200150</b>	<b>B7RMP-R200150</b>
2½" x 1½"	5.688"	2.844"	2.656"	<b>B7RMP-G250150</b>	<b>B7RMP-R250150</b>
2½" x 2"	5.688"	2.844"	2.812"	<b>B7RMP-G250200</b>	<b>B7RMP-R250200</b>
3" x 1½"	6.188"	3.093"	2.906"	<b>B7RMP-G300150</b>	<b>B7RMP-R300150</b>
3" x 2"	6.188"	3.093"	3.063"	<b>B7RMP-G300200</b>	<b>B7RMP-R300200</b>
4" x 1½"	8.125"	4.063"	3.406"	<b>B7RMP-G400150</b>	---
4" x 2"	8.125"	4.063"	3.563"	<b>B7RMP-G400200</b>	---



## Clamp Fittings - Reducers

3

## Concentric - B3114MP

Tube OD	Dimension A	304 Stainless Steel Part #	316L Stainless Steel Part #
1" x 1/2"	3.000"	---	<b>B3114MP-R10050</b>
1" x 3/4"	2.000"	---	<b>B3114MP-R10075</b>
1 1/2" x 1/2"	5.000"	---	<b>B3114MP-R15050</b>
1 1/2" x 3/4"	4.000"	---	<b>B3114MP-R15075</b>
1 1/2" x 1"	3.000"	<b>B3114MP-G150100</b>	<b>B3114MP-R150100</b>
2" x 3/4"	6.000"	---	<b>B3114MP-R20075</b>
2" x 1"	5.000"	<b>B3114MP-G200100</b>	<b>B3114MP-R200100</b>
2" x 1 1/2"	3.000"	<b>B3114MP-G200150</b>	<b>B3114MP-R200150</b>
2 1/2" x 1 1/2"	5.000"	<b>B3114MP-G250150</b>	<b>B3114MP-R250150</b>
2 1/2" x 2"	3.000"	<b>B3114MP-G250200</b>	<b>B3114MP-R250200</b>
3" x 1 1/2"	7.000"	<b>B3114MP-G300150</b>	<b>B3114MP-R300150</b>
3" x 2"	5.000"	<b>B3114MP-G300200</b>	<b>B3114MP-R300200</b>
3" x 2 1/2"	3.000"	<b>B3114MP-G300250</b>	<b>B3114MP-R300250</b>
4" x 1 1/2"	11.125"	<b>B3114MP-G400150</b>	<b>B3114MP-R400150</b>
4" x 2"	9.125"	<b>B3114MP-G400200</b>	<b>B3114MP-R400200</b>
4" x 2 1/2"	7.125"	<b>B3114MP-G400250</b>	<b>B3114MP-R400250</b>
4" x 3"	5.125"	<b>B3114MP-G400300</b>	<b>B3114MP-R400300</b>
6" x 4"	7.000"	<b>B3114MP-G600400</b>	---

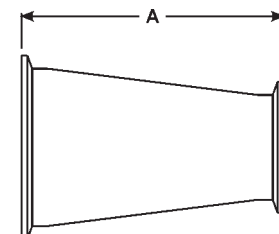
Sanitary  
Fittings

## Eccentric - B3214MP

Tube OD	Dimension A	304 Stainless Steel Part #	316L Stainless Steel Part #
1 1/2" x 1"	3.000"	<b>B3214MP-G150100</b>	<b>B3214MP-R150100</b>
2" x 1"	5.000"	<b>B3214MP-G200100</b>	<b>B3214MP-R200100</b>
2" x 1 1/2"	3.000"	<b>B3214MP-G200150</b>	<b>B3214MP-R200150</b>
2 1/2" x 1 1/2"	5.000"	<b>B3214MP-G250150</b>	<b>B3214MP-R250150</b>
2 1/2" x 2"	3.000"	<b>B3214MP-G250200</b>	<b>B3214MP-R250200</b>
3" x 1 1/2"	7.000"	<b>B3214MP-G300150</b>	<b>B3214MP-R300150</b>
3" x 2"	5.000"	<b>B3214MP-G300200</b>	<b>B3214MP-R300200</b>
3" x 2 1/2"	3.000"	<b>B3214MP-G300250</b>	<b>B3214MP-R300250</b>
4" x 2"	9.125"	<b>B3214MP-G400200</b>	<b>B3214MP-R400200</b>
4" x 2 1/2"	7.125"	<b>B3214MP-G400250</b>	<b>B3214MP-R400250</b>
4" x 3"	5.125"	<b>B3214MP-G400300</b>	<b>B3214MP-R400300</b>
6" x 3"	6.875"	<b>B3214MP-G600300</b>	---
6" x 4"	7.000"	<b>B3214MP-G600400</b>	---

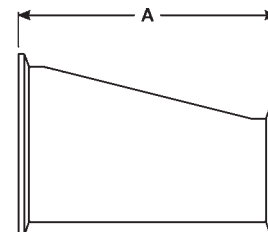

## Clamp Crosses

3

## Clamp Crosses - B9MP

Tube OD	Dimensions		304 Stainless Steel Part #	316L Stainless Steel Part #
	A	B		
1"	4.750"	2.375"	<b>B9MP-G100</b>	<b>B9MP-R100</b>
1 1/2"	5.500"	2.750"	<b>B9MP-G150</b>	<b>B9MP-R150</b>
2"	7.000"	3.500"	<b>B9MP-G200</b>	<b>B9MP-R200</b>
3"	7.500"	3.750"	<b>B9MP-G300</b>	<b>B9MP-R300</b>
4"	9.000"	4.500"	<b>B9MP-G400</b>	<b>B9MP-R400</b>

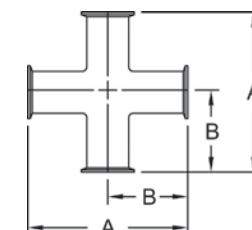

Miscellaneous Clamp Configurations

Sanitary Fittings



Laterals - B28AMP

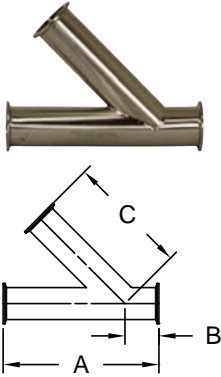

Tube OD	Dimensions			316L Stainless Steel Part #
	A	B	C	
1"	7.000"	1.500"	5.500"	<b>B28AMP-R100</b>
1½"	8.375"	1.688"	6.688"	<b>B28AMP-R150</b>
2"	9.750"	2.125"	7.625"	<b>B28AMP-R200</b>
3"	11.750"	2.375"	9.375"	<b>B28AMP-R300</b>
4"	14.062"	2.640"	11.312"	<b>B28AMP-R400</b>



True Wyes - B28BMP

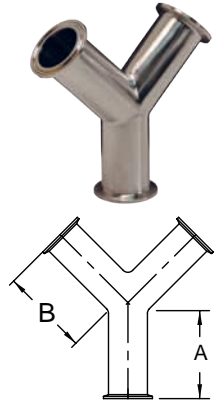

Tube OD	Dimensions		316L Stainless Steel Part #
	A	B	
1"	2.500"	2.938"	<b>B28BMP-R100</b>
1½"	2.500"	2.938"	<b>B28BMP-R150</b>
2"	3.125"	3.750"	<b>B28BMP-R200</b>
3"	4.500"	5.375"	<b>B28BMP-R300</b>
4"	6.000"	6.000"	<b>B28BMP-R400</b>



180° Return Bends - B2WUMP

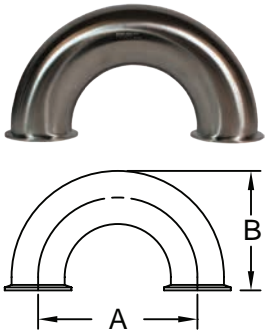

Feature:

- bends are the standard 1.5 x tube diameter

Tube OD	Dimensions		316L Stainless Steel Part #
	A	B	
1"	3.000"	2.500"	<b>B2WUMP-R100</b>
1½"	4.500"	3.500"	<b>B2WUMP-R150</b>
2"	6.000"	4.500"	<b>B2WUMP-R200</b>
3"	9.000"	6.500"	<b>B2WUMP-R300</b>
4"	12.000"	8.625"	<b>B2WUMP-R400</b>

Clamp End Protection Covers - BCC

Feature:

- Use these covers to protect all clamp ends on fittings, valves, filters and pumps.



Size	Vinyl Plastic Part #
½"	<b>BCC-050</b>
¾"	<b>BCC-075</b>
1"	<b>BCC-100</b>
1½"	<b>BCC-150</b>
2"	<b>BCC-200</b>
2½"	<b>BCC-250</b>
3"	<b>BCC-300</b>
4"	<b>BCC-400</b>
6"	<b>BCC-600</b>
8"	<b>BCC-800</b>



Quick Weld Ferrules

**Features:**

- 304 stainless construction
- just slip onto sanitary OD tube and weld
- no need to butt weld



Tube OD	Dimensions			304 Stainless Steel Part #
	A	B	C	
1"	.290"	1.005"	.870"	<b>14QMP-G100</b>
1½"	.199"	1.505"	1.370"	<b>14QMP-G150</b>
2"	.205"	2.005"	1.870"	<b>14QMP-G200</b>
2½"	.210"	2.505"	2.370"	<b>14QMP-G250</b>
3"	.216"	3.005"	2.870"	<b>14QMP-G300</b>
4"	.235"	4.005"	3.834"	<b>14QMP-G400</b>
6"	.321"	6.005"	5.782"	<b>14QMP-G600</b>

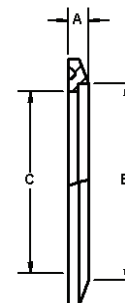

Sanitary Fittings

Breakaway Coupling - Clamp

**Application:**

- minimizes spillage and damage associated with pull away and drive away incidents

**Materials:**

- 316 stainless steel polished to standard <math>32R\_a</math>, 3A finish
- clamp gasket: EPDM standard, optional material available

**Features:**

- designed to be installed between a fixed point and a hose
- 13kN break load bolts standard, other break loads available
- coupling breaks away with an excessive load
- other sizes/connection available



**Specification:**

- working pressure: **350 PSI @ 70°F (21°C)**

Size	316 Stainless Steel Part #
2"	<b>SBC-E200CC13</b>
3"	<b>SBC-E300CC13</b>



Clamp Gaskets

Feature:

- Gasket material approved by **A3** (3A), USDA and complies with FDA's 21CFR177.2600 and 1550. PSI Service Ratings for the sanitary clamps DO NOT APPLY to connections (1" and above) using any PTFE gaskets, due to the potential for cold flow under normal operating conditions. PTFE gaskets, when used with any clamp, are likely to leak at pressures far below the published service ratings. This restriction does not apply to the fractionally sized 1/2" and 3/4" connections, due to their recessed, fully contained design.

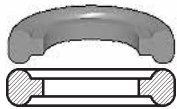

Mini

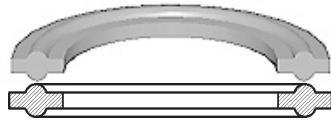

Standard - type 1

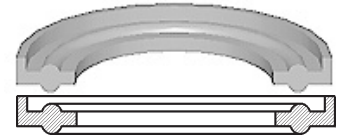
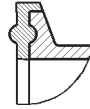

Flanged - type 2

**Buna-N - Black**

Features:

- color code: red dot
- meets 21CFR 177.2600

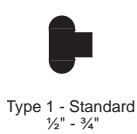

Type 1 - Standard  
1/2" - 3/4"



Type 1 - Standard  
1" and larger

Size	Buna-N Part #
1/2"	<b>42MP-U50</b>
3/4"	<b>42MP-U75</b>
1"	<b>40MP-U100</b>
1 1/2"	<b>40MP-U150</b>
2"	<b>40MP-U200</b>
2 1/2"	<b>40MP-U250</b>
3"	<b>40MP-U300</b>
4"	<b>40MP-U400</b>
5"	<b>40MP-U500</b>
6"	<b>40MP-U600</b>
8"	<b>40MP-U800</b>

**Buna-N - White**

Features:

- color code: red dot
- meets 21CFR 177.2600

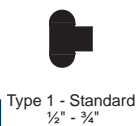

Type 1 - Standard  
1/2" - 3/4"



Type 1 - Standard  
1" and larger

Size	Buna-N Part #
1/2"	<b>42MP-UW50</b>
3/4"	<b>42MP-UW75</b>
1"	<b>40MP-UW100</b>
1 1/2"	<b>40MP-UW150</b>
2"	<b>40MP-UW200</b>
2 1/2"	<b>40MP-UW250</b>
3"	<b>40MP-UW300</b>
4"	<b>40MP-UW400</b>
6"	<b>40MP-UW600</b>

**EPDM - Black**

Features:

- color code: three green dots
- peroxide cured
- meets 21CFR 177.2600
- passed USP Class VI Cytotoxicity testing

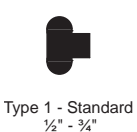

Type 1 - Standard  
1/2" - 3/4"



Type 1 - Standard  
1" and larger

Size	EPDM Part #
1/2"	<b>42MP-E50</b>
3/4"	<b>42MP-E75</b>
1"	<b>40MP-E100</b>
1 1/2"	<b>40MP-E150</b>
2"	<b>40MP-E200</b>
2 1/2"	<b>40MP-E250</b>
3"	<b>40MP-E300</b>
4"	<b>40MP-E400</b>
6"	<b>40MP-E600</b>

Visit [dixonvalve.com](http://dixonvalve.com) for sizing charts



Clamp Gaskets

FKM - Black

Features:

- color code: one white dot, one yellow dot
- peroxide cured
- meets 21CFR 177.2600
- passed USP Class VI Cytotoxicity testing

Size	FKM Part #
1/2"	42MP-SFY50
3/4"	42MP-SFY75
1"	40MP-SFY100
1 1/2"	40MP-SFY150
2"	40MP-SFY200
2 1/2"	40MP-SFY250
3"	40MP-SFY300
4"	40MP-SFY400
6"	40MP-SFY600

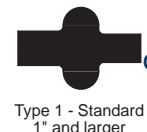
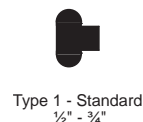

Sanitary Fittings

Silicone - White

Features:

- color code: pink dot
- peroxide cured
- meets 21CFR 177.2600
- passed USP Class VI Cytotoxicity testing

Size	Silicone Part #
1/2"	42MP-XW50
3/4"	42MP-XW75
1"	40MP-XW100
1 1/2"	40MP-XW150
2"	40MP-XW200
2 1/2"	40MP-XW250
3"	40MP-XW300
4"	40MP-XW400
6"	40MP-XW600

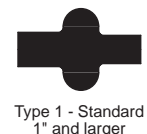
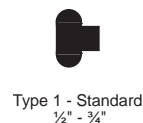

Silicone - Clear

Features:

- color code: no dot
- peroxide cured
- meets 21CFR 177.2600

Size	Silicone Part #
1/2"	42MP-XC50
3/4"	42MP-XC75
1"	40MP-XC100
1 1/2"	40MP-XC150
2"	40MP-XC200
2 1/2"	40MP-XC250
3"	40MP-XC300
4"	40MP-XC400

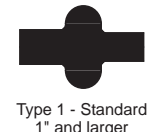
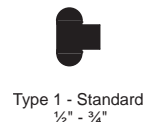

Clamp Gaskets

PTFE - White

Features:

- color code: no dot
- meets 21CFR 177.1550
- passed USP Class VI Cytotoxicity testing
- not recommended for use with bolted clamps

Size	PTFE Part #
1/2"	42MP-G50
3/4"	42MP-G75
1"	40MP-G100
1 1/2"	40MP-G150
2"	40MP-G200
2 1/2"	40MP-G250
3"	40MP-G300
4"	40MP-G400
5"	40MP-G500
6"	40MP-G600
8"	40MP-G800
10"	40MP-G1000
12"	40MP-G1200

PTFE is a material subject to plastic flow. When cycled through heat and then cooled down in process lines, PTFE gaskets will not return to the original configuration and it will continue to compress as the cycling continues. This plastic flow will allow leakage if clamp torques are not maintained. 

Sanitary Fittings



Type 1 - Standard  
1/2" - 3/4"



Type 1 - Standard  
1" and larger

Buna-N Flanged - Black

Features:

- color code: red dot
- meets 21CFR 177.2600
- not recommended for use with bolted clamps

Size	Buna-N Part #
1"	40MPF-U100
1 1/2"	40MPF-U150
2"	40MPF-U200
2 1/2"	40MPF-U250
3"	40MPF-U300
4"	40MPF-U400
6"	40MPF-U600
8"	40MPF-U800
10"	40MPF-U1000
12"	40MPF-U1200

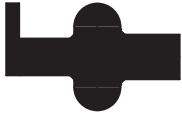

Type 2 - Flanged  
1" and larger

Buna-N Flanged - White

Features:

- color code: red dot
- meets 21CFR 177.2600
- not recommended for use with bolted clamps

Size	Buna-N Part #
1"	40MPF-UW100
1 1/2"	40MPF-UW150
2"	40MPF-UW200
2 1/2"	40MPF-UW250
3"	40MPF-UW300
4"	40MPF-UW400
6"	40MPF-UW600



Type 2 - Flanged  
1" and larger

Visit [dixonvalve.com](http://dixonvalve.com) for sizing charts

## Clamp Gaskets

## EPDM Flanged - Black

## Features:

- color code: three green dots
- peroxide cured
- meets 21CFR 177.2600
- passed USP Class VI Cytotoxicity testing
- not recommended for use with bolted clamps

Size	EPDM Part #
1"	<b>40MPF-E100</b>
1½"	<b>40MPF-E150</b>
2"	<b>40MPF-E200</b>
2½"	<b>40MPF-E250</b>
3"	<b>40MPF-E300</b>
4"	<b>40MPF-E400</b>
6"	<b>40MPF-E600</b>
8"	<b>40MPF-E800</b>
10"	<b>40MPF-E1000</b>
12"	<b>40MPF-E1200</b>

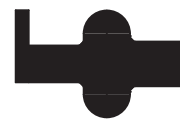
Type 2 - Flanged  
1" and larger

## FKM Flanged - Black

## Features:

- color code: one white dot, one yellow dot
- peroxide cured
- meets 21CFR 177.2600
- passed USP Class VI Cytotoxicity testing
- not recommended for use with bolted clamps

Size	FKM Part #
1"	<b>40MPF-SFY100</b>
1½"	<b>40MPF-SFY150</b>
2"	<b>40MPF-SFY200</b>
2½"	<b>40MPF-SFY250</b>
3"	<b>40MPF-SFY300</b>
4"	<b>40MPF-SFY400</b>
6"	<b>40MPF-SFY600</b>
8"	<b>40MPF-SFY800</b>
10"	<b>40MPF-SFY1000</b>
12"	<b>40MPF-SFY1200</b>

Type 2 - Flanged  
1" and larger

## Silicone Flanged - White

## Features:

- color code: pink dot
- peroxide cured
- meets 21CFR 177.2600
- passed USP Class VI Cytotoxicity testing
- not recommended for use with bolted clamps

Size	Silicone Part #
1"	<b>40MPF-XW100</b>
1½"	<b>40MPF-XW150</b>
2"	<b>40MPF-XW200</b>
2½"	<b>40MPF-XW250</b>
3"	<b>40MPF-XW300</b>
4"	<b>40MPF-XW400</b>
6"	<b>40MPF-XW600</b>
8"	<b>40MPF-XW800</b>
10"	<b>40MPF-XW1000</b>
12"	<b>40MPF-XW1200</b>

Type 2 - Flanged  
1" and largerVisit [dixonvalve.com](http://dixonvalve.com) for sizing charts

## Clamp Gaskets

## Buna-N Mesh Screen, 316

## Features:

- color code: red dot
- meets 21CFR 177.2600
- 10 mesh standard, other mesh available-call for details

Size	Buna-N Part #
1"	<b>40MPS-U100</b>
1½"	<b>40MPS-U150</b>
2"	<b>40MPS-U200</b>
2½"	<b>40MPS-U250</b>
3"	<b>40MPS-U300</b>
4"	<b>40MPS-U400</b>

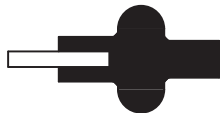

Type 3 - Mesh

## PTFE Envelope with EPDM Filler

## Features:

- color code: usually not marked
- peroxide cured EPDM
- meets 21CFR 177.1550
- PTFE passed USP Class VI Cytotoxicity testing

Size	PTFE with EPDM Filler Part #
½"	<b>42MP-GRE50</b>
1"	<b>40MP-GRE100</b>
1½"	<b>40MP-GRE150</b>
2"	<b>40MP-GRE200</b>
2½"	<b>40MP-GRE250</b>
3"	<b>40MP-GRE300</b>
4"	<b>40MP-GRE400</b>
6"	<b>40MP-GRE600</b>



## PTFE Envelope with FKM Filler

## Features:

- color code: usually not marked
- peroxide cured FKM
- meets 21CFR 177.1550
- PTFE passed USP Class VI Cytotoxicity testing

Size	PTFE with FKM Filler Part #
1"	<b>40MP-GR100</b>
1½"	<b>40MP-GR150</b>
2"	<b>40MP-GR200</b>
2½"	<b>40MP-GR250</b>
3"	<b>40MP-GR300</b>
4"	<b>40MP-GR400</b>
6"	<b>40MP-GR600</b>



PTFE is a material subject to plastic flow. When cycled through heat and then cooled down in process lines, PTFE gaskets will not return to the original configuration and it will continue to compress as the cycling continues. This plastic flow will allow leakage if clamp torques are not maintained.





## Metal Detectable Clamp Gaskets

**Materials:**

- Metal detectable gaskets are impregnated with stainless steel particles. The addition of stainless steel allows a gasket or gasket pieces to be found with metal detection equipment.

**Buna-N****Features:**

- good general use where temperature extremes do not exist
- minimum temperature: **-20°F (-29°C)**
- maximum temperature: **212°F (100°C)**

Size	Buna-N Part #
1"	<b>40MP-UZ100</b>
1½"	<b>40MP-UZ150</b>
2"	<b>40MP-UZ200</b>
2½"	<b>40MP-UZ250</b>
3"	<b>40MP-UZ300</b>
4"	<b>40MP-UZ400</b>

Type 1 - Standard  
1" and larger**EPDM****Features:**

- resistant to steam, water and base solutions
- minimum temperature: **-70°F (-57°C)**
- maximum temperature: **310°F (154°C)**

Size	EPDM Part #
1"	<b>40MP-EZ100</b>
1½"	<b>40MP-EZ150</b>
2"	<b>40MP-EZ200</b>
2½"	<b>40MP-EZ250</b>
3"	<b>40MP-EZ300</b>
4"	<b>40MP-EZ400</b>

Type 1 - Standard  
1" and larger**FKM****Features:**

- resistant to steam, heat and high acid solutions
- minimum temperature: **-20°F (-29°C)**
- maximum temperature: **410°F (410°C)**

Size	FKM Part #
1"	<b>40MP-SFYZ100</b>
1½"	<b>40MP-SFYZ150</b>
2"	<b>40MP-SFYZ200</b>
2½"	<b>40MP-SFYZ250</b>
3"	<b>40MP-SFYZ300</b>
4"	<b>40MP-SFYZ400</b>

Type 1 - Standard  
1" and larger

Cam and Groove Transition Fittings <sup>1</sup>

## Adapter x Clamp End



Size	316 Stainless Steel Part #
1½"	<b>RE150SE</b>
2"	<b>RE200SE</b>
3"	<b>RE300SE</b>

## Coupler x Clamp End



Size	316 Stainless Steel Part #
1½"	<b>RC150SE</b>
2"	<b>RC200SE</b>
3"	<b>RC300SE</b>

Dixon® Weld to Tube Cam and Groove <sup>1</sup>

## Features:

- designed to be welded to standard sanitary tubing
- 316 stainless steel investment casting

## Adapter x Weld to Tube End



Size	316 Stainless Steel Part #
1"	<b>RE100BT</b>
1½"	<b>RE150BT</b>
2"	<b>RE200BT</b>
3"	<b>RE300BT</b>

## Boss-Lock™ Coupler x Weld to Tube End



Size	316 Stainless Steel Part #
1"	<b>RC100BT</b>
1½"	<b>RC150BT</b>
2"	<b>RC200BT</b>
3"	<b>RC300BT</b>

<sup>1</sup> for all other cam and groove options see pages 121-162

## European Fittings - DIN

## DIN 11851 Round Nuts - 13R

Nominal Size	A (mm)	B (mm)	C (mm)	304 Stainless Steel Part Number
1"	21.0	63.0	52 x 1/6	<b>13R-G100DIN</b>
1½"	21.0	78.0	65 x 1/6	<b>13R-G150DIN</b>
2"	22.0	92.0	78 x 1/6	<b>13R-G200DIN</b>
2½"	25.0	112.0	95 x 1/6	<b>13R-G250DIN</b>
3"	30.0	127.0	110 x 1/4	<b>13R-G300DIN</b>
4"	31.0	148.0	130 x 1/4	<b>13R-G400DIN</b>

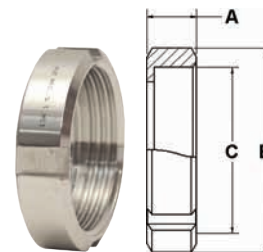

Sanitary Fittings

## DIN Blank Caps - 16AMP

Nominal Size	A (mm)	B (mm)	C (mm)	D (mm)	316 Stainless Steel Part Number
1"	13.0	44.0	9.9	35.0	<b>16AMP-R100DIN</b>
1½"	13.0	56.0	9.9	48.0	<b>16AMP-R150DIN</b>
2"	14.0	68.0	10.9	61.0	<b>16AMP-R200DIN</b>
2½"	16.0	86.0	11.9	79.0	<b>16AMP-R250DIN</b>
3"	16.0	100.0	11.9	93.0	<b>16AMP-R300DIN</b>
4"	20.1	120.0	15.0	114.0	<b>16AMP-R400DIN</b>

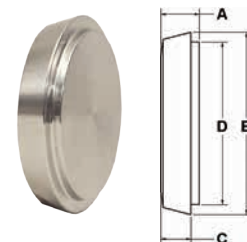

## DIN Welding Males - 15A

Nominal Size	WT (mm)	A (mm)	B (mm)	C (mm)	316 Stainless Steel Part Number
1"	1.6	29.0	52 x 1/6	25.4	<b>15A-R100DIN</b>
1½"	1.6	33.0	65 x 1/6	38.1	<b>15A-R150DIN</b>
2"	1.7	35.0	78 x 1/6	51.0	<b>15A-R200DIN</b>
2½"	1.6	40.0	95 x 1/6	63.5	<b>15A-R250DIN</b>
3"	1.6	45.0	110 x 1/4	76.2	<b>15A-R300DIN</b>
4"	2.0	54.0	130 x 1/4	101.6	<b>15A-R400DIN</b>

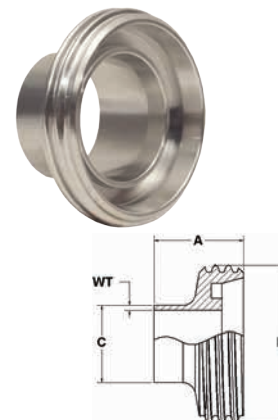

## DIN Welding Liners - 14A

Nominal Size	WT (mm)	A (mm)	B (mm)	C (mm)	316 Stainless Steel Part Number
1"	1.6	22.0	44.0	25.4	<b>14A-R100DIN</b>
1½"	1.6	26.0	56.0	38.1	<b>14A-R150DIN</b>
2"	1.7	28.0	68.0	51.0	<b>14A-R200DIN</b>
2½"	1.6	32.0	86.0	63.5	<b>14A-R250DIN</b>
3"	1.6	37.0	100.0	76.2	<b>14A-R300DIN</b>
4"	2.0	44.0	121.0	101.6	<b>14A-R400DIN</b>

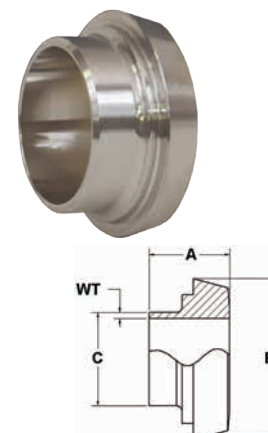

Manufactured in accordance to Imperial DIN 11851

European Fittings - SMS

Sanitary Fittings

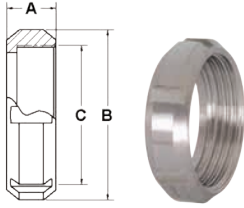

Round Nuts - 13R

Nominal Size	A (mm)	B (mm)	C (mm)	304 Stainless Steel Part Number
1"	19.0	51.0	40 x 1/6	<b>13R-G100SMS</b>
1½"	23.0	74.0	60 x 1/6	<b>13R-G150SMS</b>
2"	24.0	84.0	70 x 1/6	<b>13R-G200SMS</b>
2½"	28.0	100.0	85 x 1/6	<b>13R-G250SMS</b>
3"	30.0	114.0	98 x 1/6	<b>13R-G300SMS</b>
4"	31.0	138.0	125 x 1/4	<b>13R-G400SMS</b>

Blank Caps - 16AMP

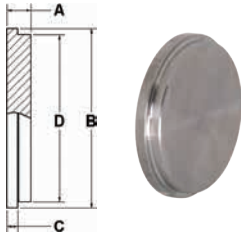

Nominal Size	A (mm)	B (mm)	C (mm)	D (mm)	316 Stainless Steel Part Number
1"	7.5	35.5	3.6	32.0	<b>16AMP-R100SMS</b>
1½"	8.0	55.0	4.1	47.9	<b>16AMP-R150SMS</b>
2"	9.0	65.0	4.1	60.4	<b>16AMP-R200SMS</b>
2½"	9.0	80.0	4.1	73.5	<b>16AMP-R250SMS</b>
3"	11.0	93.0	5.1	86.5	<b>16AMP-R300SMS</b>
4"	11.0	118.0	5.8	112.5	<b>16AMP-R400SMS</b>

Welding Males - 15A

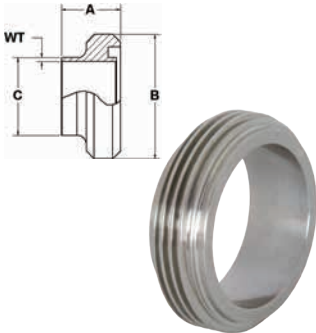

Nominal Size	WT (mm)	A (mm)	B (mm)	C (mm)	316 Stainless Steel Part Number
1"	1.25	19.0	40 x 1/6	25.0	<b>15A-R100SMS</b>
1½"	1.25	23.0	60 x 1/6	38.0	<b>15A-R150SMS</b>
2"	1.25	23.0	70 x 1/6	51.0	<b>15A-R200SMS</b>
2½"	1.50	27.0	85 x 1/6	63.5	<b>15A-R250SMS</b>
3"	1.60	27.0	98 x 1/6	76.1	<b>15A-R300SMS</b>
4"	2.00	30.0	125 x 1/4	101.6	<b>15A-R400SMS</b>

Welding Liners - 14A

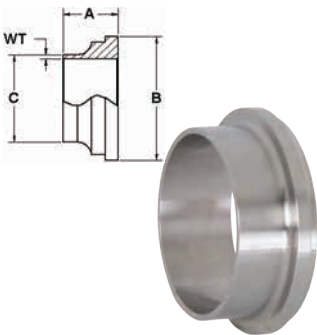

Nominal Size	WT (mm)	A (mm)	B (mm)	C (mm)	316 Stainless Steel Part Number
1"	1.25	15.5	35.5	25.0	<b>14A-R100SMS</b>
1½"	1.25	16.0	55.0	38.0	<b>14A-R150SMS</b>
2"	1.25	17.0	65.0	51.0	<b>14A-R200SMS</b>
2½"	1.50	17.0	80.0	63.5	<b>14A-R250SMS</b>
3"	1.60	19.0	93.0	76.1	<b>14A-R300SMS</b>
4"	2.00	19.0	118.0	101.6	<b>14A-R400SMS</b>

DIN and SMS Spanner Wrenches - SP

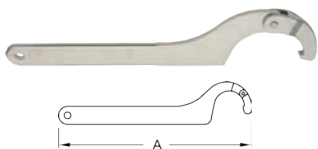

Used On Nominal Size	A (mm)	Nickel Plated Steel Part Number
1" - 1½"	247.7	<b>DIN-SMS-60/90SP</b>
2" - 4"	330.2	<b>DIN-SMS90/155SP</b>

Manufactured in accordance to Swedish Milk Standard ISO 2037 and ISO 2851

## European Fittings - RJT BS: 4825

## Hex Nuts - 13H

Nominal Size	A (mm)	B (mm)	304 Stainless Steel Part Number
1"	22.2	50.80	<b>13H-G100RJT</b>
1½"	22.2	65.02	<b>13H-G150RJT</b>
2"	22.2	79.25	<b>13H-G200RJT</b>
2½"	22.2	91.95	<b>13H-G250RJT</b>
3"	22.2	104.65	<b>13H-G300RJT</b>
4"	22.2	130.05	<b>13H-G400RJT</b>

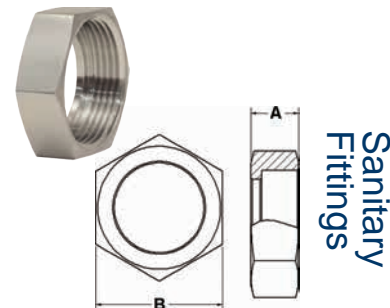

Sanitary Fittings

## Blank Caps - 13RBN

Nominal Size	A (mm)	B (mm)	304 Stainless Steel Part Number
1"	8.2	41.3	<b>13RBN-G100RJT</b>
1½"	8.2	54.0	<b>13RBN-G150RJT</b>
2"	8.2	66.7	<b>13RBN-G200RJT</b>
2½"	8.2	79.4	<b>13RBN-G250RJT</b>
3"	8.2	92.1	<b>13RBN-G300RJT</b>
4"	8.2	117.5	<b>13RBN-G400RJT</b>

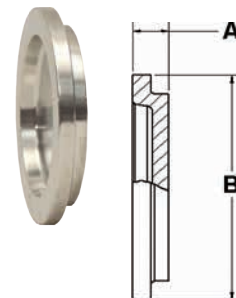

## Welding Males - 15A

Nominal Size	WT (mm)	A (mm)	B (mm)	C (mm)	316 Stainless Steel Part Number
1"	1.73	27.0	45.72 x 1/8	25.65	<b>15A-R100RJT</b>
1½"	1.73	27.0	58.42 x 1/8	38.35	<b>15A-R150RJT</b>
2"	1.73	27.0	72.72 x 1/6	51.05	<b>15A-R200RJT</b>
2½"	1.73	27.0	85.42 x 1/6	63.75	<b>15A-R250RJT</b>
3"	1.73	27.0	98.12 x 1/6	76.45	<b>15A-R300RJT</b>
4"	2.13	27.0	123.52 x 1/6	101.85	<b>15A-R400RJT</b>

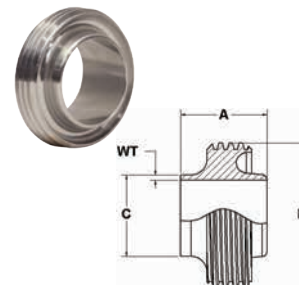

## Welding Liners - 14A

Nominal Size	WT (mm)	A (mm)	B (mm)	C (mm)	316 Stainless Steel Part Number
1"	1.73	19.5	41.3	25.65	<b>14A-R100RJT</b>
1½"	1.73	19.5	54.0	38.35	<b>14A-R150RJT</b>
2"	1.73	19.5	66.7	51.05	<b>14A-R200RJT</b>
2½"	1.73	19.5	79.4	63.75	<b>14A-R250RJT</b>
3"	1.73	19.5	92.1	76.45	<b>14A-R300RJT</b>
4"	2.13	19.5	117.5	101.85	<b>14A-R400RJT</b>

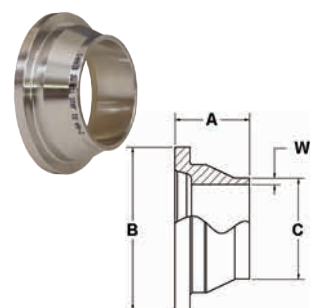

## Spanner Wrenches - SP

Size	A (mm)	B (mm)	Aluminum Part Number
1"	254.00	50.80	<b>RJT-100SP</b>
1½"	292.10	65.02	<b>RJT-150SP</b>
2"	304.80	79.25	<b>RJT-200SP</b>
2½"	342.80	91.95	<b>RJT-250SP</b>
3"	368.30	104.65	<b>RJT-300SP</b>
4"	444.50	130.05	<b>RJT-400SP</b>

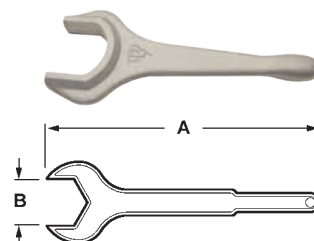

Manufactured in accordance to BS 4825

## European Fittings - Gaskets

## DIN Buna-N - Black

## Feature:

- color code: red dot

## Approval:

- meets 21CFR 177.2600

Nominal Size	ID (mm)	OD (mm)	DIN 11851 Part Number
1"	29.97	39.88	<b>40MP-U100DIN</b>
1½"	41.91	52.07	<b>40MP-U150DIN</b>
2"	54.10	64.01	<b>40MP-U200DIN</b>
2½"	71.12	81.03	<b>40MP-U250DIN</b>
3"	85.09	95.00	<b>40MP-U300DIN</b>
4"	103.89	114.05	<b>40MP-U400DIN</b>

Sanitary Fittings



## SMS Buna-N - Black

## Feature:

- color code: red dot

## Approval:

- meets 21CFR 177.2600

Nominal Size	ID (mm)	OD (mm)	L Style Part Number
1"	24.89	32.00	<b>40MP-U100SMS</b>
1½"	37.49	48.00	<b>40MP-U150SMS</b>
2"	50.80	61.00	<b>40MP-U200SMS</b>
2½"	63.50	73.40	<b>40MP-U250SMS</b>
3"	75.95	86.10	<b>40MP-U300SMS</b>
4"	103.89	114.00	<b>40MP-U400SMS</b>



## RJT Buna-N - Black

## Feature:

- color code: red dot

## Approval:

- meets 21CFR 177.2600

Nominal Size	ID (mm)	OD (mm)	Part Number
1"	26.92	6.35	<b>40MP-U100RJT</b>
1½"	39.62	6.35	<b>40MP-U150RJT</b>
2"	52.32	6.35	<b>40MP-U200RJT</b>
2½"	65.08	6.35	<b>40MP-U250RJT</b>
3"	77.72	6.35	<b>40MP-U300RJT</b>
4"	103.12	6.35	<b>40MP-U400RJT</b>





Bevel Seat Nuts - 13H

Feature:

- maximum operating pressure: **400 PSI**

Tube OD	Dimensions		304 Stainless Steel (CF8) Part #
	A	B	
1"	.906"	1.812"	<b>13H-G100</b>
1½"	.968"	2.406"	<b>13H-G150</b>
2"	1.062"	3.000"	<b>13H-G200</b>
2½"	1.187"	3.594"	<b>13H-G250</b>
3"	1.281"	4.188"	<b>13H-G300</b>
4"	1.500"	5.438"	<b>13H-G400</b>

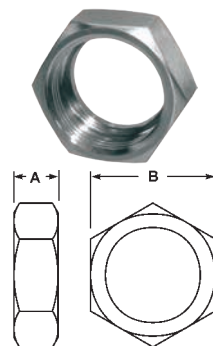

Sanitary Fittings

Bevel Seat Wrenches

Single Sided Hex - 25H

Tube OD	Dimensions		Aluminum Part #
	A	B	
1"	10.500"	1.812"	<b>25H-100</b>
1½"	12.000"	2.406"	<b>25H-150</b>
2"	14.000"	3.000"	<b>25H-200</b>
2½"	16.250"	3.594"	<b>25H-250</b>
3"	18.500"	4.188"	<b>25H-300</b>
4"	19.500"	5.438"	<b>25H-400</b>

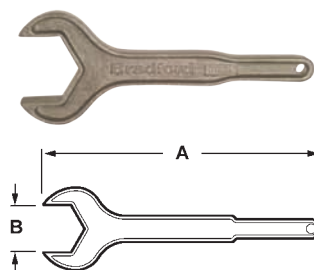

Two Sided Hex - 25H

Tube OD	Dimensions			Aluminum Part #
	A	B	C	
1½" x 1"	12.000"	2.406"	1.812"	<b>25H-150100</b>
2" x 1½"	14.000"	3.000"	2.406"	<b>25H-200150</b>
2½" x 2"	16.500"	3.594"	3.000"	<b>25H-250200</b>
3" x 2"	18.000"	4.188"	3.000"	<b>25H-300200</b>
3" x 2½"	18.000"	4.188"	3.594"	<b>25H-300250</b>

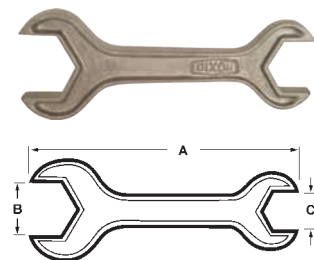

Bevel Seat Ferrules

Short Plain Weld - 14PRF

Sanitary Fittings

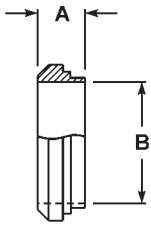

Tube OD	Dimensions		304 Stainless Steel Part #
	A	B	
1"	.718"	.870"	<b>14PRF-G100</b>
1½"	.718"	1.370"	<b>14PRF-G150</b>
2"	.750"	1.870"	<b>14PRF-G200</b>
2½"	.875"	2.370"	<b>14PRF-G250</b>
3"	.906"	2.870"	<b>14PRF-G300</b>
4"	1.031"	3.834"	<b>14PRF-G400</b>



Long Plain Weld - 14A

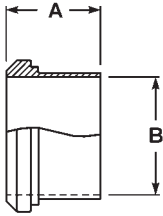

Tube OD	Dimensions		304 Stainless Steel Part #
	A	B	
1"	1.375"	.870"	<b>14A-G100</b>
1½"	1.500"	1.370"	<b>14A-G150</b>
2"	1.500"	1.870"	<b>14A-G200</b>
2½"	1.750"	2.370"	<b>14A-G250</b>
3"	1.750"	2.870"	<b>14A-G300</b>
4"	1.750"	3.834"	<b>14A-G400</b>



Recessless Plain for Expanding - 14R

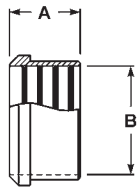

Tube OD	Dimensions		304 Stainless Steel Part #
	A	B	
1½"	1.125"	1.505"	<b>14R-G150</b>
2"	1.312"	2.005"	<b>14R-G200</b>
2½"	1.375"	2.505"	<b>14R-G250</b>
3"	1.437"	3.005"	<b>14R-G300</b>
4"	1.500"	4.005"	<b>14R-G400</b>

<sup>1</sup> Meets 3-A Standard Number 63-03 when used to modify or repair existing on-site farm milk handling systems.



Short Threaded Weld - 15TRF

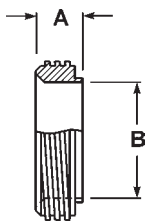

Tube OD	Dimensions		304 Stainless Steel Part #
	A	B	
1"	.718"	.870"	<b>15TRF-G100</b>
1½"	.718"	1.370"	<b>15TRF-G150</b>
2"	.750"	1.870"	<b>15TRF-G200</b>
2½"	.875"	2.370"	<b>15TRF-G250</b>
3"	.906"	2.870"	<b>15TRF-G300</b>
4"	1.031"	3.834"	<b>15TRF-G400</b>



Bevel Seat Ferrules

Long Threaded Weld - 15A



Tube OD	Dimensions		304 Stainless Steel Part #
	A	B	
1"	1.375"	.870"	<b>15A-G100</b>
1½"	1.500"	1.370"	<b>15A-G150</b>
2"	1.500"	1.870"	<b>15A-G200</b>
2½"	1.750"	2.370"	<b>15A-G250</b>
3"	1.750"	2.870"	<b>15A-G300</b>
4"	1.750"	3.834"	<b>15A-G400</b>

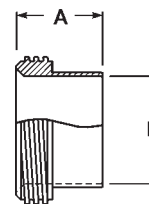

Sanitary Fittings

Recessless Threaded for Expanding - 15R



Tube OD	Dimensions		304 Stainless Steel Part #
	A	B	
1"	.812"	1.005"	<b>15R-G100</b>
1½"	1.125"	1.505"	<b>15R-G150</b>
2"	1.375"	2.005"	<b>15R-G200</b>
2½"	1.500"	2.505"	<b>15R-G250</b>
3"	1.625"	3.005"	<b>15R-G300</b>
4"	1.675"	4.005"	<b>15R-G400</b>

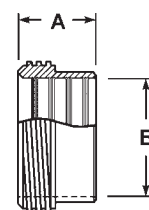

<sup>1</sup> Meets 3-A Standard Number 63-03 when used to modify or repair existing on-site farm milk handling systems.

Bevel Seat End Caps

Plain Solid - 16A



Tube OD	Dimension A	304 Stainless Steel Part #
1"	1.312"	<b>16A-G100</b>
1½"	1.843"	<b>16A-G150</b>
2"	2.375"	<b>16A-G200</b>
2½"	2.906"	<b>16A-G250</b>
3"	3.437"	<b>16A-G300</b>
4"	4.500"	<b>16A-G400</b>



Bevel Seat Adapters

Plain x Male NPT with Hex Nut - 14-19

Tube OD	Dimension A	304 Stainless Steel Part #
1½"	3.250"	<b>14-19-G150</b>
2"	3.312"	<b>14-19-G200</b>
3"	4.250"	<b>14-19-G300</b>

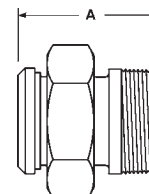

Bevel Seat Elbows

90° Threaded x Plain with Hex Nut - B2F

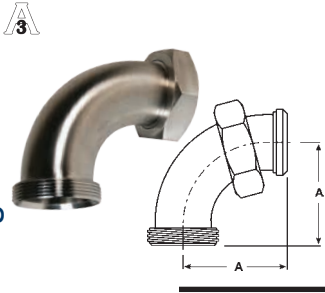

Tube OD	Dimension A	304 Stainless Steel Part #
1½"	2.968"	<b>B2F-G150</b>
2"	3.750"	<b>B2F-G200</b>
2½"	4.625"	<b>B2F-G250</b>
3"	5.406"	<b>B2F-G300</b>

90° Plain x Plain with Hex Nut - B2E

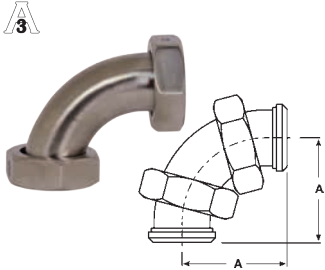

Tube OD	Dimension A	304 Stainless Steel Part #
1½"	2.968"	<b>B2E-G150</b>
2"	3.750"	<b>B2E-G200</b>
2½"	4.625"	<b>B2E-G250</b>
3"	5.406"	<b>B2E-G300</b>

Bevel Seat Reducers

Plain x Threaded Concentric - B3115F

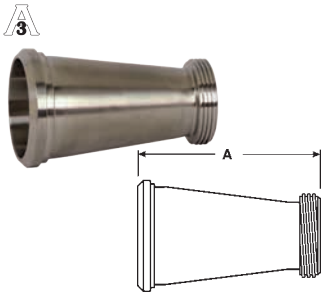

Tube OD	Dimension A	304 Stainless Steel Part #
2" x 1½"	3.468"	<b>B3115F-G200150</b>
2½" x 2"	3.625"	<b>B3115F-G250200</b>
3" x 2"	5.656"	<b>B3115F-G300200</b>
3" x 2½"	3.781"	<b>B3115F-G300250</b>
4" x 3"	5.937"	<b>B3115F-G400300</b>

Threaded x Plain with Hex Nut Concentric - B31TP

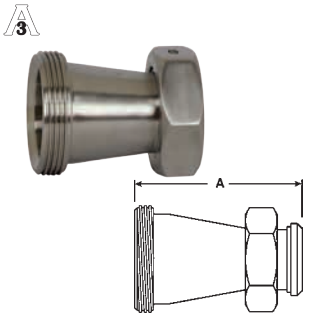

Tube OD	Dimension A	304 Stainless Steel Part #
2" x 1½"	3.468"	<b>B31TP-G200150</b>
2½" x 2"	3.625"	<b>B31TP-G250200</b>
3" x 2"	5.656"	<b>B31TP-G300200</b>
3" x 2½"	3.781"	<b>B31TP-G300250</b>
4" x 3"	5.937"	<b>B31TP-G400300</b>

Breakaway Coupling - Bevel Seat

**Application:**

- minimizes spillage and damage associated with pull away and drive away incidents

**Materials:**

- 316 stainless steel polished to standard <math>32R\_a</math>, 3A finish
- clamp gasket: EPDM standard, optional material available

**Features:**

- designed to be installed between a fixed point and a hose
- 13kN break load bolts standard, other break loads available
- coupling breaks away with an excessive load
- other sizes / connections available

**Specification:**

- working pressure: **350 PSI @ 70°F (21°C)**



Size	316 Stainless Steel Part #
2"	<b>SBC-E200TP13</b>
3"	<b>SBC-E300TP13</b>





Bevel Seat Gaskets

Buna-N - Black

Features:

- color code: red dot
- meets 21CFR 177.2600

Size	Buna-N Part #
1"	40BS-O100
1½"	40BS-O150
2"	40BS-O200
2½"	40BS-O250
3"	40BS-O300
4"	40BS-O400

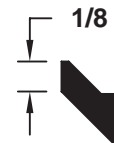

Sanitary Fittings

PTFE - White

Features:

- color code: no dot
- meets 21CFR 177.1550
- passed USP Class VI Cytotoxicity testing

Size	PTFE Part #
1"	40BS-S100
1½"	40BS-S150
2"	40BS-S200
2½"	40BS-S250
3"	40BS-S300
4"	40BS-S400

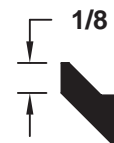

Heavy PTFE - White

Features:

- color code: no dot
- meets 21CFR 177.1550
- passed USP Class VI Cytotoxicity testing

Size	PTFE Part #
1"	40BS-H100
1½"	40BS-H150
2"	40BS-H200
2½"	40BS-H250
3"	40BS-H300
4"	40BS-H400

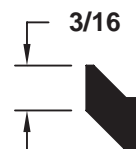

PTFE is a material subject to plastic flow. When cycled through heat and then cooled down in process lines, PTFE gaskets will not return to the original configuration and it will continue to compress as the cycling continues. This plastic flow will allow leakage if clamp torques are not maintained.



I-line / Q-line Clamps

Heavy Duty - 13ILH

Sanitary Fittings



Tube OD	Service Pressure PSI Rating @ 70°F (21°C) <sup>1</sup>	Service Pressure PSI Rating @ 250°F (121°C) <sup>1</sup>	Dimension A	304 Stainless Steel Part #
1" - 1½"	<b>700</b>	<b>250</b>	2.122"	<b>13ILH100-150</b>
2"	<b>450</b>	<b>250</b>	2.654"	<b>13ILH200</b>
2½"	<b>450</b>	<b>200</b>	3.185"	<b>13ILH250</b>
3"	<b>350</b>	<b>150</b>	3.717"	<b>13ILH300</b>
4"	<b>200</b>	<b>125</b>	4.820"	<b>13ILH400</b>
6"	<b>150</b>	<b>100</b>	7.689"	<b>13ILH600</b>
8"	<b>125</b>	<b>75</b>	9.689"	<b>13ILH800</b>

<sup>1</sup> wing nut tightened to 25 in. lbs. of torque

Bolted - 13ILB

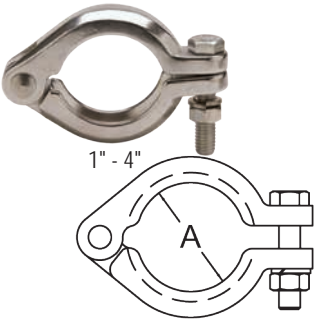

Tube OD	Service Pressure PSI Rating @ 70°F (21°C) <sup>1</sup>	Service Pressure PSI Rating @ 250°F (121°C) <sup>1</sup>	Dimension A	304 Stainless Steel Part #
1" - 1½"	<b>1220</b>	<b>1100</b>	2.122"	<b>13ILB100-150</b>
2"	<b>900</b>	<b>830</b>	2.654"	<b>13ILB200</b>
2½"	<b>720</b>	<b>660</b>	3.185"	<b>13ILB250</b>
3"	<b>600</b>	<b>550</b>	3.717"	<b>13ILB300</b>
4"	<b>570</b>	<b>525</b>	4.820"	<b>13ILB400</b>

<sup>1</sup> nut tightened to 20 ft. lbs. of torque

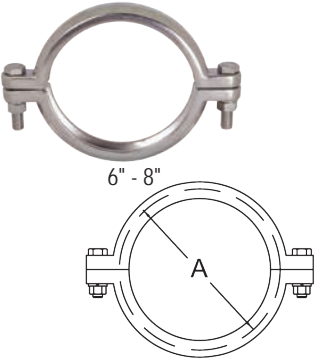

Tube OD	Service Pressure PSI Rating @ 70°F (21°C) <sup>1</sup>	Service Pressure PSI Rating @ 250°F (121°C) <sup>1</sup>	Dimension A	304 Stainless Steel Part #
6"	<b>300</b>	<b>200</b>	7.689"	<b>13ILB600</b>
8"	<b>250</b>	<b>150</b>	9.689"	<b>13ILB800</b>

<sup>1</sup> nut tightened to 20 ft. lbs. of torque



I-Line - Ferrules

Male Short Weld - 14WI



Tube OD	Dimension A	304 Stainless Steel Part #	316L Stainless Steel Part #
1"	.600"	<b>14WI-G100</b>	<b>14WI-R100</b>
1½"	.765"	<b>14WI-G150</b>	<b>14WI-R150</b>
2"	.790"	<b>14WI-G200</b>	<b>14WI-R200</b>
2½"	.848"	<b>14WI-G250</b>	<b>14WI-R250</b>
3"	.906"	<b>14WI-G300</b>	<b>14WI-R300</b>
4"	1.031"	<b>14WI-G400</b>	<b>14WI-R400</b>
6"	.940"	---	<b>14WI-R600</b>
8"	.940"	---	<b>14WI-R800</b>

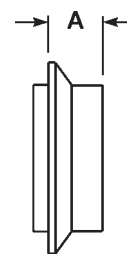

Sanitary Fittings

Male Long Weld - 14WLI



Tube OD	Dimension A	304 Stainless Steel Part #	316L Stainless Steel Part #
1"	1.562"	<b>14WLI-G100</b>	<b>14WLI-R100</b>
1½"	1.843"	<b>14WLI-G150</b>	<b>14WLI-R150</b>
2"	2.062"	<b>14WLI-G200</b>	<b>14WLI-R200</b>
2½"	2.188"	<b>14WLI-G250</b>	<b>14WLI-R250</b>
3"	2.375"	<b>14WLI-G300</b>	<b>14WLI-R300</b>
4"	2.688"	<b>14WLI-G400</b>	<b>14WLI-R400</b>
6"	2.688"	---	<b>14WLI-R600</b>

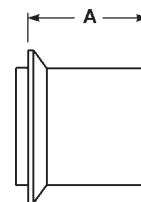

Female Short Weld - 15WI



Tube OD	Dimension A	304 Stainless Steel Part #	316L Stainless Steel Part #
1"	.785"	<b>15WI-G100</b>	<b>15WI-R100</b>
1½"	.950"	<b>15WI-G150</b>	<b>15WI-R150</b>
2"	1.040"	<b>15WI-G200</b>	<b>15WI-R200</b>
2½"	1.160"	<b>15WI-G250</b>	<b>15WI-R250</b>
3"	1.220"	<b>15WI-G300</b>	<b>15WI-R300</b>
4"	1.350"	<b>15WI-G400</b>	<b>15WI-R400</b>
6"	1.125"	---	<b>15WI-R600</b>
8"	1.125"	---	<b>15WI-R800</b>



Female Long Weld - 15WLI



Tube OD	Dimension A	304 Stainless Steel Part #	316L Stainless Steel Part #
1"	1.750"	<b>15WLI-G100</b>	<b>15WLI-R100</b>
1½"	2.031"	<b>15WLI-G150</b>	<b>15WLI-R150</b>
2"	2.312"	<b>15WLI-G200</b>	<b>15WLI-R200</b>
2½"	2.500"	<b>15WLI-G250</b>	<b>15WLI-R250</b>
3"	2.688"	<b>15WLI-G300</b>	<b>15WLI-R300</b>
4"	3.000"	<b>15WLI-G400</b>	<b>15WLI-R400</b>
6"	3.000"	---	<b>15WLI-R600</b>

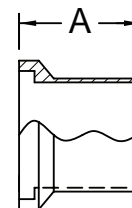

Q-Line - Ferrules

Weld - 14WQ

Sanitary Fittings

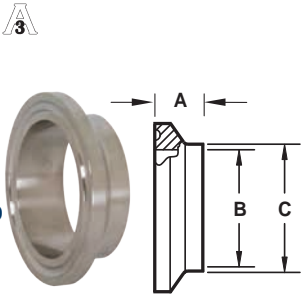

Tube OD	Dimensions			304 Stainless Steel Part #
	A	B	C	
1"	.531"	.870"	1.000"	<b>14WQ-G100</b>
1½"	.563"	1.370"	1.500"	<b>14WQ-G150</b>
2"	.813"	1.870"	2.000"	<b>14WQ-G200</b>
2½"	.938"	2.370"	2.500"	<b>14WQ-G250</b>
3"	.938"	2.870"	3.000"	<b>14WQ-G300</b>
4"	1.000"	3.834"	4.000"	<b>14WQ-G400</b>

I-Line / Q-Line - End Caps

Male Solid - 16AI-14I

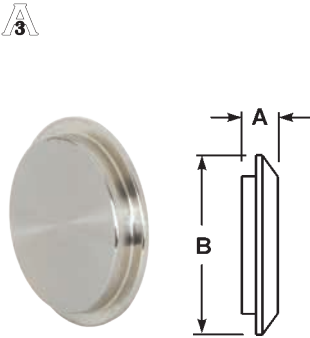

Tube OD	Dimensions		304 Stainless Steel Part #	316L Stainless Steel Part #
	A	B		
1"	.500"	1.985"	<b>16AI-14I100</b>	<b>16AI-14I100R</b>
1½"	.500"	1.985"	<b>16AI-14I150</b>	<b>16AI-14I150R</b>
2"	.562"	2.640"	<b>16AI-14I200</b>	<b>16AI-14I200R</b>
2½"	.750"	3.307"	<b>16AI-14I250</b>	<b>16AI-14I250R</b>
3"	.750"	3.870"	<b>16AI-14I300</b>	<b>16AI-14I300R</b>
4"	.750"	4.870"	<b>16AI-14I400</b>	<b>16AI-14I400R</b>
6"	.750"	7.495"	---	<b>16AI-14I600R</b>
8"	.800"	9.495"	---	<b>16AI-14I800R</b>

Female Solid - 16AI-15I

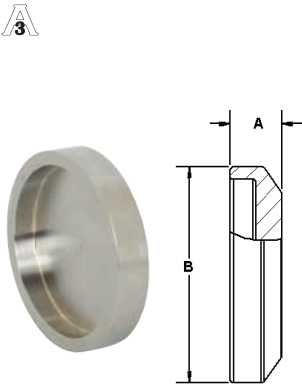

Tube OD	Dimensions		304 Stainless Steel Part #	316L Stainless Steel Part #
	A	B		
1"	.500"	1.985"	<b>16AI-15I100</b>	<b>16AI-15I100R</b>
1½"	.500"	1.985"	<b>16AI-15I150</b>	<b>16AI-15I150R</b>
2"	.562"	2.640"	<b>16AI-15I200</b>	<b>16AI-15I200R</b>
2½"	.750"	3.307"	<b>16AI-15I250</b>	<b>16AI-15I250R</b>
3"	.750"	3.870"	<b>16AI-15I300</b>	<b>16AI-15I300R</b>
4"	.765"	4.870"	<b>16AI-15I400</b>	<b>16AI-15I400R</b>
6"	.869"	7.495"	---	<b>16AI-15I600R</b>
8"	.800"	9.495"	---	<b>16AI-15I800R</b>

Solid - 16AQ

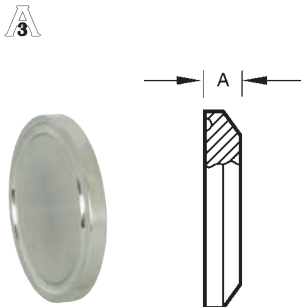

Tube OD	Dimension A	304 Stainless Steel Part #
1"	.313"	<b>16AQ-G100</b>
1½"	.313"	<b>16AQ-G150</b>
2"	.438"	<b>16AQ-G200</b>
2½"	.500"	<b>16AQ-G250</b>
3"	.500"	<b>16AQ-G300</b>
4"	.625"	<b>16AQ-G400</b>

## I-line Gaskets

## 3/32" Buna-N - Black

## Features:

- color code: red dot
- meets 21CFR 177.2600

Size	Buna-N Part #
1"	40IH100
1½"	40IH150
2"	40IH200
2½"	40IH250
3"	40IH300
4"	40IH400
6"	40IH600
8"	40IH800

Sanitary  
Fittings

## 1/16" PTFE - White

## Features:

- color code: no dot
- meets 21CFR 177.1550
- passed USP class VI cytotoxicity testing

Size	PTFE Part #
1"	40IT100
1½"	40IT150
2"	40IT200
2½"	40IT250
3"	40IT300
4"	40IT400
6"	40IT600
8"	40IT800



PTFE is a material subject to plastic flow. When cycled through heat and then cooled down in process lines, PTFE gaskets will not return to the original configuration and it will continue to compress as the cycling continues. This plastic flow will allow leakage if clamp torques are not maintained.



## 3/32" EPDM - White

## Features:

- color code: three green dots
- meets 21CFR 177.2600
- passed USP class VI cytotoxicity testing
- peroxide cured

Size	EPDM Part #
1"	40IE100
1½"	40IE150
2"	40IE200
2½"	40IE250
3"	40IE300
4"	40IE400
6"	40IE600
8"	40IE800



## I-line Gaskets

1/16" FKM - Black

## Features:

- color code: one white dot, one yellow dot
- meets 21CFR 177.1550
- passed USP Class VI Cytotoxicity testing
- peroxide cured



Size	FKM Part #
1"	40IV100
1½"	40IV150
2"	40IV200
2½"	40IV250
3"	40IV300
4"	40IV400
6"	40IV600
8"	40IV800

## Q-line Gaskets

Buna-N - Black

## Features:

- color code: red dot
- meets 21CFR 177.2600



Size	Buna-N Part #
1"	40QH100
1½"	40QH150
2"	40QH200
2½"	40QH250
3"	40QH300
4"	40QH400

PTFE - White

## Features:

- color code: no dot
- meets 21CFR 177.1550
- passed USP Class VI Cytotoxicity testing



Size	PTFE Part #
1"	40QT100
1½"	40QT150
2"	40QT200
2½"	40QT250
3"	40QT300
4"	40QT400

PTFE is a material subject to plastic flow. When cycled through heat and then cooled down in process lines, PTFE gaskets will not return to the original configuration and it will continue to compress as the cycling continues. This plastic flow will allow leakage if clamp torques are not maintained. 



Pipe Size Clamps

Schedule 5S and 10S Single Pin Heavy Duty - 13MHHV

Pipe Size	Service Pressure PSI Rating @ 70°F (21°C) <sup>1</sup>	Dimension A	304 Stainless Steel Part #
1"	500	2.122"	13MHHV100
1½"	450	2.654"	13MHHV150
2"	400	3.185"	13MHHV200
2½"	350	3.717"	13MHHV250
3"	250	4.263"	13MHHV300
4"	150	5.263"	13MHHV400
6"	100	7.500"	13MHHV600

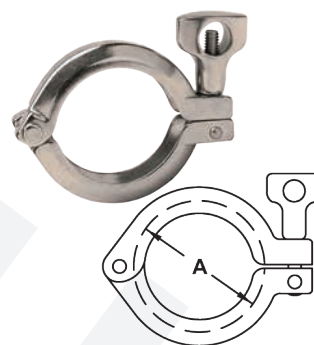

Sanitary  
Fittings

<sup>1</sup> wing nut tightened to 25 in. lbs. of torque

Bolted - 13MHPV400

Pipe Size	Service Pressure PSI Rating @ 70°F (21°C) <sup>1</sup>	Dimension A	304 Stainless Steel Part #
4"	400	5.187"	13MHPV400

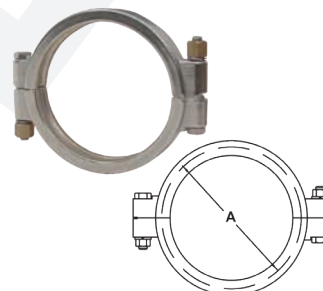

<sup>1</sup> nut tightened to 20 ft. lbs. of torque

• For additional information on pipe dimensions please reference dixonvalve.com.

Pipe Size Ferrules

Schedule 5S Short Weld - 14WMV

Pipe Size	Dimensions			316L Stainless Steel Part #
	A	B	C	
1"	.500"	1.185"	1.315"	14WMV-R100
1½"	.500"	1.770"	1.900"	14WMV-R150
2"	.500"	2.245"	2.375"	14WMV-R200
2½"	.500"	2.709"	2.875"	14WMV-R250
3"	.500"	3.334"	3.500"	14WMV-R300
4"	.625"	4.334"	4.500"	14WMV-R400
6"	.875"	6.407"	6.625"	14WMV-R600

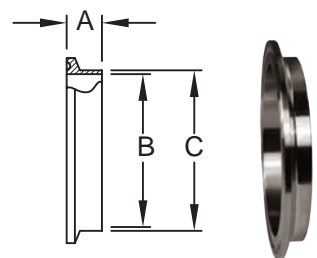

3

Schedule 10S Short Weld - 14WMX

Pipe Size	Dimensions			316L Stainless Steel Part #
	A	B	C	
1"	.500"	1.097"	1.315"	14WMX-R100
1½"	.500"	1.682"	1.900"	14WMX-R150
2"	.500"	2.157"	2.375"	14WMX-R200
2½"	.500"	2.635"	2.875"	14WMX-R250
3"	.500"	3.260"	3.500"	14WMX-R300
4"	.625"	4.260"	4.500"	14WMX-R400
6"	.875"	6.350"	6.625"	14WMX-R600

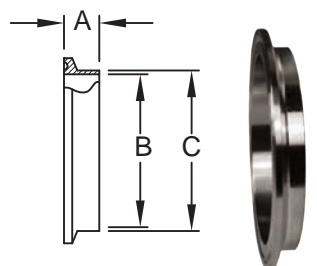

3

• For additional information on pipe dimensions please reference dixonvalve.com.

Pipe Size Ferrules



Schedule 5S Long Weld - L14AM7V

Sanitary Fittings

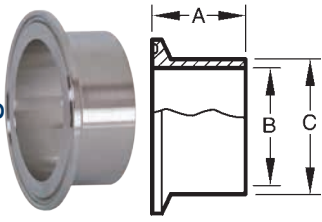

Pipe Size	Dimensions			316L Stainless Steel Part #
	A	B	C	
1"	1.125"	1.185"	1.315"	<b>L14AM7V-R100</b>
1½"	1.125"	1.770"	1.900"	<b>L14AM7V-R150</b>
2"	1.125"	2.245"	2.375"	<b>L14AM7V-R200</b>
2½"	1.125"	2.709"	2.875"	<b>L14AM7V-R250</b>
3"	1.125"	3.334"	3.500"	<b>L14AM7V-R300</b>
4"	1.125"	4.334"	4.500"	<b>L14AM7V-R400</b>



Schedule 10S Long Weld - L14AM7X

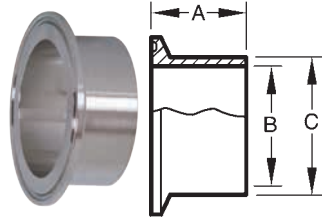

Pipe Size	Dimensions			316L Stainless Steel Part #
	A	B	C	
1"	1.125"	1.097"	1.315"	<b>L14AM7X-R100</b>
1½"	1.125"	1.682"	1.900"	<b>L14AM7X-R150</b>
2"	1.125"	2.157"	2.375"	<b>L14AM7X-R200</b>
2½"	1.125"	2.635"	2.875"	<b>L14AM7X-R250</b>
3"	1.125"	3.260"	3.500"	<b>L14AM7X-R300</b>
4"	1.125"	4.260"	4.500"	<b>L14AM7X-R400</b>

- For additional information on pipe dimensions please reference [dixonvalve.com](http://dixonvalve.com).

Pipe Size End Caps



Schedule 5S and 10S Solid - 16AMV

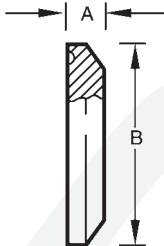

Pipe Size	Dimensions		304 Stainless Steel Part #	316L Stainless Steel Part #
	A	B		
1"	.250"	1.984"	<b>16AMV-G100</b>	<b>16AMV-R100</b>
1½"	.250"	2.516"	<b>16AMV-G150</b>	<b>16AMV-R150</b>
2"	.250"	3.047"	<b>16AMV-G200</b>	<b>16AMV-R200</b>
2½"	.250"	3.579"	<b>16AMV-G250</b>	<b>16AMV-R250</b>
3"	.312"	4.125"	<b>16AMV-G300</b>	<b>16AMV-R300</b>
4"	.312"	5.125"	<b>16AMV-G400</b>	<b>16AMV-R400</b>

- Specify if you are using a piping system or a tubing system when ordering.
- For additional information on pipe dimensions please reference [dixonvalve.com](http://dixonvalve.com).

Pipe Size Adapters

Tube OD Weld x Schedule 5S Weld - B19WV



Pipe Size	Dimension A	Tube Wall Thickness	Pipe Wall Thickness	316L Stainless Steel Part #
1"	2.000"	.065"	.065"	<b>B19WV-R100</b>
1½"	2.500"	.065"	.065"	<b>B19WV-R150</b>
2"	2.500"	.065"	.065"	<b>B19WV-R200</b>
2½"	2.500"	.065"	.084"	<b>B19WV-R250</b>
3"	2.500"	.065"	.084"	<b>B19WV-R300</b>
4"	3.000"	.084"	.084"	<b>B19WV-R400</b>

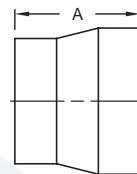

Sanitary Fittings

Tube OD Weld x Schedule 10S Weld - B19WX



Pipe Size	Dimension A	Tube Wall Thickness	Pipe Wall Thickness	316L Stainless Steel Part #
1"	2.000"	.065"	.109"	<b>B19WX-R100</b>
1½"	2.500"	.065"	.109"	<b>B19WX-R150</b>
2"	2.500"	.065"	.109"	<b>B19WX-R200</b>
2½"	2.500"	.065"	.120"	<b>B19WX-R250</b>
3"	2.500"	.065"	.120"	<b>B19WX-R300</b>
4"	3.000"	.084"	.120"	<b>B19WX-R400</b>

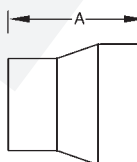

Clamp x Schedule 10S Weld - B19MPX



Pipe Size	Dimensions			Pipe Wall Thickness	316L Stainless Steel Part #
	A	B	C		
1"	1.125"	1.097"	1.315"	.109"	<b>B19MPX-R100</b>
1½"	1.125"	1.682"	1.900"	.109"	<b>B19MPX-R150</b>
2"	1.125"	2.157"	2.375"	.109"	<b>B19MPX-R200</b>
2½"	1.125"	2.635"	2.875"	.120"	<b>B19MPX-R250</b>
3"	1.125"	3.260"	3.500"	.120"	<b>B19MPX-R300</b>
4"	1.125"	4.260"	4.500"	.120"	<b>B19MPX-R400</b>

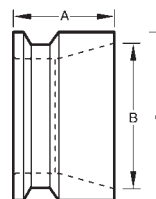

- For additional information on pipe dimensions please reference [dixonvalve.com](http://dixonvalve.com).

Pipe Size Hangers

Hex with Rubber Grommets - B24RV<sup>1</sup>

Sanitary Fittings

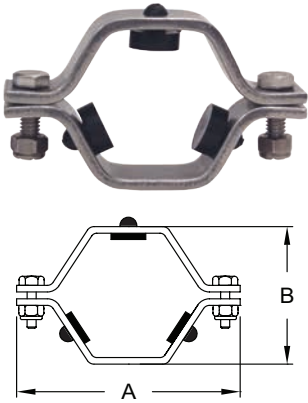

Pipe Size	Dimensions		304 Stainless Steel Part #
	A	B	
1"	3.7"	2.2"	<b>B24RV-G100</b>
1½"	4.4"	2.8"	<b>B24RV-G150</b>
2"	5.0"	3.3"	<b>B24RV-G200</b>
2½"	5.6"	3.7"	<b>B24RV-G250</b>
3"	6.1"	4.3"	<b>B24RV-G300</b>
4"	7.6"	5.0"	<b>B24RV-G400</b>
6"	9.8"	7.2"	<b>B24RV-G600</b>

<sup>1</sup> for coupler options call Dixon®

Hex with Polypropylene Sleeves - B24PV<sup>1</sup>

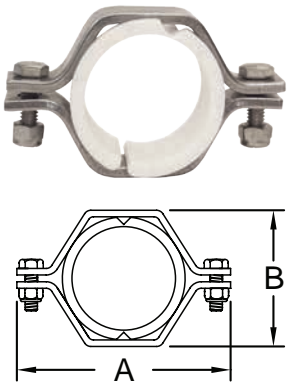

Pipe Size	Dimensions		304 Stainless Steel Part #
	A	B	
1"	3.750"	2.125"	<b>B24PV-G100</b>
1½"	4.312"	2.625"	<b>B24PV-G150</b>
2"	5.000"	3.125"	<b>B24PV-G200</b>
2½"	5.625"	3.785"	<b>B24PV-G250</b>
3"	6.000"	4.250"	<b>B24PV-G300</b>
4"	7.500"	5.127"	<b>B24PV-G400</b>
6"	9.750"	7.375"	<b>B24PV-G600</b>

<sup>1</sup> for coupler options call Dixon®

Sleeves - 13PV

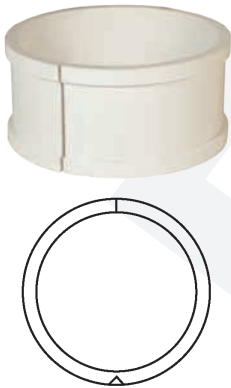

Size	Polypropylene Part #
1"	<b>13PV-100</b>
1½"	<b>13PV-150</b>
2"	<b>13PV-200</b>
2½"	<b>13PV-250</b>
3"	<b>13PV-300</b>
4"	<b>13PV-400</b>
6"	<b>13PV-600</b>

• For additional information on pipe dimensions please reference [dixonvalve.com](http://dixonvalve.com).

## Schedule 5S and 10S Pipe Gaskets

**Buna-N - 40MPV-U, Black****Features:**

- color code: red dot
- meets 21CFR 177.2600

Size	Buna-N Part #
1"	<b>40MPV-U100</b>
1½"	<b>40MPV-U150</b>
2"	<b>40MPV-U200</b>
2½"	<b>40MPV-U250</b>
3"	<b>40MPV-U300</b>
4"	<b>40MPV-U400</b>

Sanitary  
Fittings**PTFE - 40MPV-G, White****Features:**

- color code: no dot
- meets 21CFR 177.1550
- passed USP Class VI Cytotoxicity testing
- not recommended for use with bolted clamps



Size	PTFE Part #
1"	<b>40MPV-G100</b>
1½"	<b>40MPV-G150</b>
2"	<b>40MPV-G200</b>
2½"	<b>40MPV-G250</b>
3"	<b>40MPV-G300</b>
4"	<b>40MPV-G400</b>



PTFE is a material subject to plastic flow. When cycled through heat and then cooled down in process lines, PTFE gaskets will not return to the original configuration and it will continue to compress as the cycling continues. This plastic flow will allow leakage if clamp torques are not maintained.



Polished Weld Elbows

Sanitary Fittings

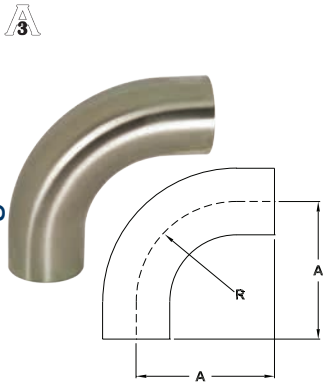

90° with Tangents - B2S

Tube OD	Dimensions		Wall Thickness	Polished ID/OD	Polished ID/OD
	A	R		304 Stainless Steel Part #	316L Stainless Steel Part #
½"	3.000"	1.125"	.065"	---	<b>B2S-R50P</b>
¾"	3.000"	1.125"	.065"	---	<b>B2S-R75P</b>
1"	2.062"	1.500"	.065"	<b>B2S-G100P</b>	<b>B2S-R100P</b>
1½"	2.937"	2.250"	.065"	<b>B2S-G150P</b>	<b>B2S-R150P</b>
2"	4.062"	3.000"	.065"	<b>B2S-G200P</b>	<b>B2S-R200P</b>
2½"	5.187"	3.750"	.065"	<b>B2S-G250P</b>	<b>B2S-R250P</b>
3"	6.312"	4.500"	.065"	<b>B2S-G300P</b>	<b>B2S-R300P</b>
4"	8.312"	6.000"	.083"	<b>B2S-G400P</b>	<b>B2S-R400P</b>



90° - B2WCL

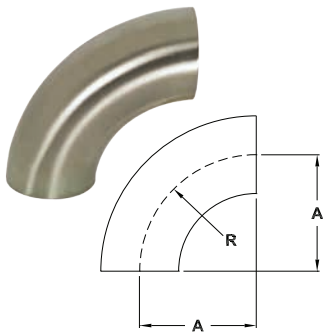

Tube OD	Dimensions		Wall Thickness	Polished ID/OD	Polished ID/OD
	A	R		304 Stainless Steel Part #	316L Stainless Steel Part #
½"	1.125"	1.125"	.065"	---	<b>B2WCL-R50P</b>
¾"	1.125"	1.125"	.065"	---	<b>B2WCL-R75P</b>
1"	1.500"	1.500"	.065"	<b>B2WCL-G100P</b>	<b>B2WCL-R100P</b>
1½"	2.250"	2.250"	.065"	<b>B2WCL-G150P</b>	<b>B2WCL-R150P</b>
2"	3.000"	3.000"	.065"	<b>B2WCL-G200P</b>	<b>B2WCL-R200P</b>
2½"	3.750"	3.750"	.065"	<b>B2WCL-G250P</b>	<b>B2WCL-R250P</b>
3"	4.500"	4.500"	.065"	<b>B2WCL-G300P</b>	<b>B2WCL-R300P</b>
4"	6.000"	6.000"	.083"	<b>B2WCL-G400P</b>	<b>B2WCL-R400P</b>
6"	9.000"	9.000"	.109"	<b>B2WCL-G600P</b>	<b>B2WCL-R600P</b>
8"	12.000"	12.000"	.109"	<b>B2WCL-G800P</b>	<b>B2WCL-R800P</b>



90° Clamp x Weld - B2CM

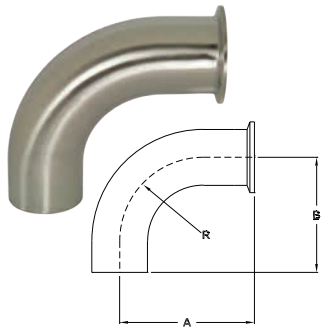

Tube OD	Dimensions			Wall Thickness	Polished ID/OD	Polished ID/OD
	A	B	R		304 Stainless Steel Part #	316L Stainless Steel Part #
1"	2.562"	2.062"	1.500"	.065"	<b>B2CM-G100</b>	<b>B2CM-R100</b>
1½"	3.438"	2.937"	2.250"	.065"	<b>B2CM-G150</b>	<b>B2CM-R150</b>
2"	4.562"	4.062"	3.000"	.065"	<b>B2CM-G200</b>	<b>B2CM-R200</b>
2½"	5.688"	5.187"	3.750"	.065"	<b>B2CM-G250</b>	<b>B2CM-R250</b>
3"	6.812"	6.312"	4.500"	.065"	<b>B2CM-G300</b>	<b>B2CM-R300</b>
4"	8.937"	8.312"	6.000"	.083"	<b>B2CM-G400</b>	<b>B2CM-R400</b>



90° Plain Bevel Seat with Hex Nut x Weld - B2FP

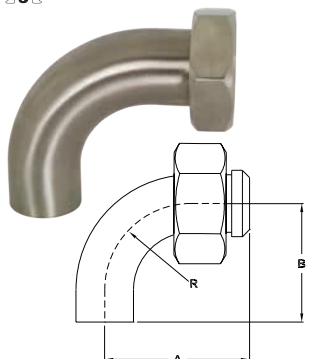

Tube OD	Dimensions			Wall Thickness	Polished ID/OD
	A	B	R		304 Stainless Steel Part #
1½"	3.656"	2.937"	2.250"	.065"	<b>B2FP-G150</b>
2"	4.812"	4.062"	3.000"	.065"	<b>B2FP-G200</b>
2½"	6.062"	5.187"	3.750"	.065"	<b>B2FP-G250</b>
3"	7.218"	6.312"	4.500"	.065"	<b>B2FP-G300</b>

Polished Weld Elbows

45° with Tangents - B2KS



Tube OD	Dimensions		Wall Thickness	Polished ID/OD	Polished ID/OD
	A	R		304 Stainless Steel Part #	316L Stainless Steel Part #
¾"	2.250"	1.125"	.065"	---	<b>B2KS-R75P</b>
1"	1.188"	1.500"	.065"	<b>B2KS-G100P</b>	<b>B2KS-R100P</b>
1½"	1.625"	2.250"	.065"	<b>B2KS-G150P</b>	<b>B2KS-R150P</b>
2"	2.312"	3.000"	.065"	<b>B2KS-G200P</b>	<b>B2KS-R200P</b>
2½"	3.000"	3.750"	.065"	<b>B2KS-G250P</b>	<b>B2KS-R250P</b>
3"	3.688"	4.500"	.065"	<b>B2KS-G300P</b>	<b>B2KS-R300P</b>
4"	4.812"	6.000"	.083"	<b>B2KS-G400P</b>	<b>B2KS-R400P</b>

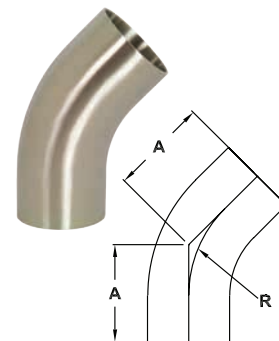

Sanitary Fittings

45° - B2WK



Tube OD	Dimensions		Wall Thickness	Polished ID/OD	Polished ID/OD
	A	R		304 Stainless Steel Part #	316L Stainless Steel Part #
1"	.62"	1.500"	.065"	<b>B2WK-G100P</b>	<b>B2WK-R100P</b>
1½"	.94"	2.250"	.065"	<b>B2WK-G150P</b>	<b>B2WK-R150P</b>
2"	1.25"	3.000"	.065"	<b>B2WK-G200P</b>	<b>B2WK-R200P</b>
2½"	1.56"	3.750"	.065"	<b>B2WK-G250P</b>	<b>B2WK-R250P</b>
3"	1.87"	4.500"	.065"	<b>B2WK-G300P</b>	<b>B2WK-R300P</b>
4"	2.50"	6.000"	.083"	<b>B2WK-G400P</b>	<b>B2WK-R400P</b>
6"	3.73"	9.000"	.109"	<b>B2WK-G600P</b>	<b>B2WK-R600P</b>
8"	4.97"	12.000"	.109"	---	<b>B2WK-R800P</b>

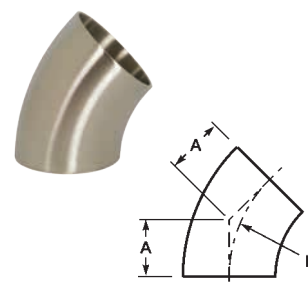

45° Clamp x Weld - B2KM



Tube OD	Dimensions			Wall Thickness	Polished ID/OD	Polished ID/OD
	A	B	R		304 Stainless Steel Part #	316L Stainless Steel Part #
1"	1.188"	1.688"	1.500"	.065"	<b>B2KM-G100</b>	<b>B2KM-R100</b>
1½"	1.625"	2.125"	2.250"	.065"	<b>B2KM-G150</b>	<b>B2KM-R150</b>
2"	2.312"	2.812"	3.000"	.065"	<b>B2KM-G200</b>	<b>B2KM-R200</b>
2½"	3.000"	3.500"	3.750"	.065"	<b>B2KM-G250</b>	<b>B2KM-R250</b>
3"	3.688"	4.188"	4.500"	.065"	<b>B2KM-G300</b>	<b>B2KM-R300</b>
4"	4.812"	5.437"	6.000"	.083"	<b>B2KM-G400</b>	<b>B2KM-R400</b>

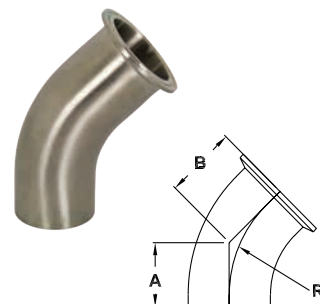

Polished Weld Sweep Elbows

Feature:

- tangents, 45° and other radii elbows are available, call Dixon® for information

Sanitary Fittings

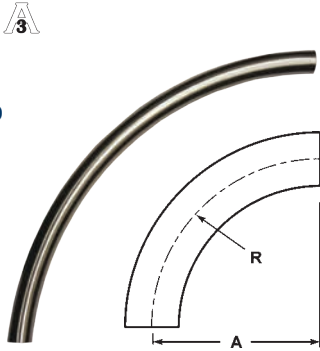

12" 90° - B2SXL

Tube OD	Dimensions		316L Stainless Steel Part #
	A	R	
1½"	12.00"	12.00"	<b>B2SXL12-R150</b>
2"	12.00"	12.00"	<b>B2SXL12-R200</b>
3"	12.00"	12.00"	<b>B2SXL12-R300</b>
4"	12.00"	12.00"	<b>B2SXL12-R400</b>

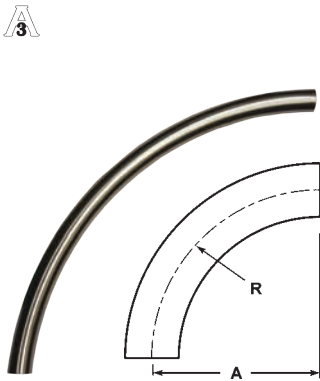

18" 90° - B2SXL

Tube OD	Dimensions		316L Stainless Steel Part #
	A	R	
1½"	18.00"	18.00"	<b>B2SXL18-R150</b>
2"	18.00"	18.00"	<b>B2SXL18-R200</b>
2½"	18.00"	18.00"	<b>B2SXL18-R250</b>
3"	18.00"	18.00"	<b>B2SXL18-R300</b>

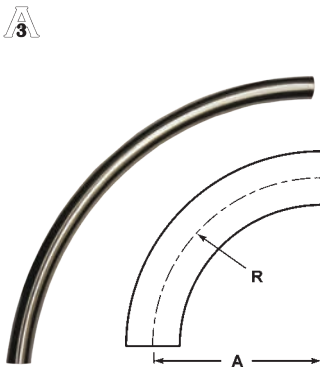

24" 90° - B2SXL

Tube OD	Dimensions		316L Stainless Steel Part #
	A	R	
1½"	24.00"	24.00"	<b>B2SXL24-R150</b>
2"	24.00"	24.00"	<b>B2SXL24-R200</b>
2½"	24.00"	24.00"	<b>B2SXL24-R250</b>
3"	24.00"	24.00"	<b>B2SXL24-R300</b>

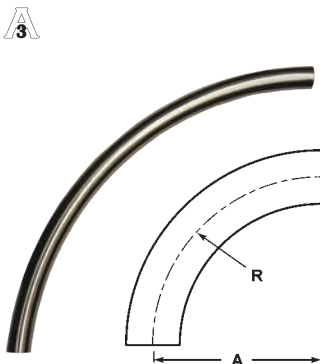

36" 90° - B2SXL

Tube OD	Dimensions		316L Stainless Steel Part #
	A	R	
3"	36.00"	36.00"	<b>B2SXL36-R300</b>
4"	36.00"	36.00"	<b>B2SXL36-R400</b>



Polished Weld Tees

Short - B7WWW



Tube OD	Dimensions		Wall Thickness	Polished ID/OD	Polished ID/OD
	A	B		304 Stainless Steel Part #	316L Stainless Steel Part #
1"	2.250"	1.125"	.065"	<b>B7WWW-G100P</b>	<b>B7WWW-R100P</b>
1½"	3.312"	1.656"	.065"	<b>B7WWW-G150P</b>	<b>B7WWW-R150P</b>
2"	4.124"	2.062"	.065"	<b>B7WWW-G200P</b>	<b>B7WWW-R200P</b>
2½"	4.688"	2.344"	.065"	<b>B7WWW-G250P</b>	<b>B7WWW-R250P</b>
3"	5.188"	2.594"	.065"	<b>B7WWW-G300P</b>	<b>B7WWW-R300P</b>
4"	6.876"	3.438"	.083"	<b>B7WWW-G400P</b>	<b>B7WWW-R400P</b>

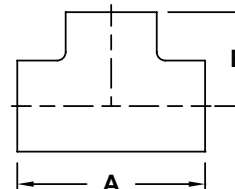

Sanitary Fittings

Long - B7W



Tube OD	Dimensions		Wall Thickness	Polished ID/OD	Polished ID/OD
	A	B		304 Stainless Steel Part #	316L Stainless Steel Part #
¾"	4.000"	2.000"	.065"	---	<b>B7W-R75P</b>
1"	3.750"	1.875"	.065"	<b>B7W-G100P</b>	<b>B7W-R100P</b>
1½"	4.500"	2.250"	.065"	<b>B7W-G150P</b>	<b>B7W-R150P</b>
2"	6.000"	3.000"	.065"	<b>B7W-G200P</b>	<b>B7W-R200P</b>
2½"	6.000"	3.000"	.065"	<b>B7W-G250P</b>	<b>B7W-R250P</b>
3"	6.500"	3.250"	.065"	<b>B7W-G300P</b>	<b>B7W-R300P</b>
4"	7.750"	3.875"	.083"	<b>B7W-G400P</b>	<b>B7W-R400P</b>

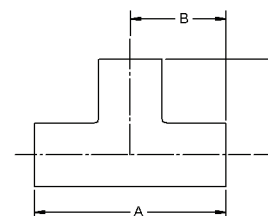

Reducing - B7RWWW



Tube OD	Dimensions				Wall Thick.	Polished ID/OD	Polished ID/OD
	A	B	C	D		304 Stainless Steel Part #	316L Stainless Steel Part #
1½" x 1"	3.312"	1.375"	1.500"	1.000"	.065"	<b>B7RWWW-G150100P</b>	<b>B7RWWW-R150100P</b>
2" x 1"	4.124"	1.625"	2.000"	1.000"	.065"	<b>B7RWWW-G200100P</b>	<b>B7RWWW-R200100P</b>
2" x 1½"	4.124"	1.906"	2.000"	1.500"	.065"	<b>B7RWWW-G200150P</b>	<b>B7RWWW-R200150P</b>
2½" x 1½"	4.688"	2.156"	2.500"	1.500"	.065"	<b>B7RWWW-G250150P</b>	<b>B7RWWW-R250150P</b>
2½" x 2"	4.688"	2.312"	2.500"	2.000"	.065"	<b>B7RWWW-G250200P</b>	<b>B7RWWW-R250200P</b>
3" x 1½"	5.188"	2.406"	3.000"	1.500"	.065"	<b>B7RWWW-G300150P</b>	<b>B7RWWW-R300150P</b>
3" x 2"	5.188"	2.562"	3.000"	2.000"	.065"	<b>B7RWWW-G300200P</b>	<b>B7RWWW-R300200P</b>
4" x 2"	6.876"	3.062"	4.000"	2.000"	.083"	<b>B7RWWW-G400200P</b>	<b>B7RWWW-R400200P</b>
4" x 3"	6.876"	3.094"	4.000"	3.000"	.083"	<b>B7RWWW-G400300P</b>	<b>B7RWWW-R400300P</b>

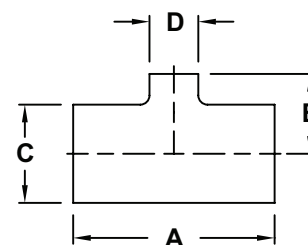

Weld Adapters  
Long Hose - 14WHRL

Feature:

- suitable for use with band clamps

Sanitary Fittings

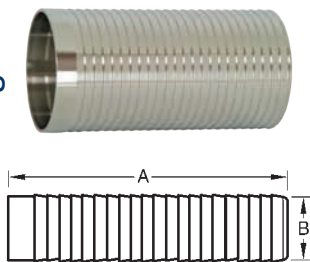

Tube OD	Dimensions		Wall Thickness	316L Stainless Steel Part #
	A	B		
1"	3.000"	1.030"	.116"	<b>14WHRL-R100</b>
1½"	4.500"	1.530"	.116"	<b>14WHRL-R150</b>
2"	4.500"	2.030"	.116"	<b>14WHRL-R200</b>
2½"	5.000"	2.530"	.116"	<b>14WHRL-R250</b>
3"	5.000"	3.030"	.116"	<b>14WHRL-R300</b>
4"	4.875"	4.030"	.116"	<b>14WHRL-R400</b>

Use of PVC tubing requires special installation techniques to prevent leakage. All assembly work must be done with heated tube. Cold durometer is 90 as opposed to rubber hose at 65 to 70 durometer. Banding buckles must be at 180° from one another. 

3

Polished Weld Reducers

Concentric - B31W

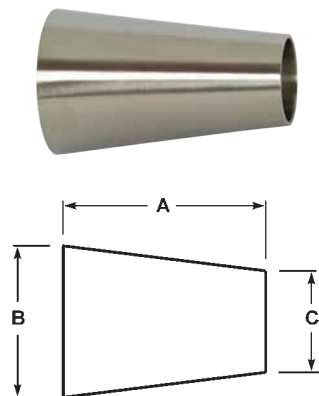

Tube OD	Dimensions			Wall Thickness	Polished ID/OD 304 Stainless Steel Part #	Polished ID/OD 316L Stainless Steel Part #
	A	B	C			
¾" x ½"	1.000"	.750"	.500"	.065"	---	<b>B31W-R7550P</b>
1" x ½"	2.000"	1.000"	.500"	.065"	---	<b>B31W-R10050P</b>
1" x ¾"	1.000"	1.000"	.750"	.065"	---	<b>B31W-R10075P</b>
1½" x ¾"	3.000"	1.500"	.750"	.065"	---	<b>B31W-R15075P</b>
1½" x 1"	2.000"	1.500"	1.000"	.065"	<b>B31W-G150100P</b>	<b>B31W-R150100P</b>
2" x 1"	4.000"	2.000"	1.000"	.065"	<b>B31W-G200100P</b>	<b>B31W-R200100P</b>
2" x 1½"	2.000"	2.000"	1.500"	.065"	<b>B31W-G200150P</b>	<b>B31W-R200150P</b>
2½" x 1½"	4.000"	2.500"	1.500"	.065"	<b>B31W-G250150P</b>	<b>B31W-R250150P</b>
2½" x 2"	2.000"	2.500"	2.000"	.065"	<b>B31W-G250200P</b>	<b>B31W-R250200P</b>
3" x 1½"	6.000"	3.000"	1.500"	.065"	<b>B31W-G300150P</b>	<b>B31W-R300150P</b>
3" x 2"	4.000"	3.000"	2.000"	.065"	<b>B31W-G300200P</b>	<b>B31W-R300200P</b>
3" x 2½"	2.000"	3.000"	2.500"	.065"	<b>B31W-G300250P</b>	<b>B31W-R300250P</b>
4" x 2"	8.000"	4.000"	2.000"	.083"	<b>B31W-G400200P</b>	<b>B31W-R400200P</b>
4" x 2½"	6.000"	4.000"	2.500"	.083"	<b>B31W-G400250P</b>	<b>B31W-R400250P</b>
4" x 3"	4.000"	4.000"	3.000"	.083"	<b>B31W-G400300P</b>	<b>B31W-R400300P</b>
6" x 3"	5.500"	6.000"	3.000"	.109"	<b>B31W-G600300P</b>	<b>B31W-R600300P</b>
6" x 4"	5.500"	6.000"	4.000"	.109"	<b>B31W-G600400P</b>	<b>B31W-R600400P</b>

3

Eccentric - B32W

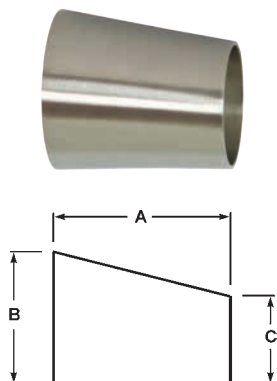

Tube OD	Dimensions			Wall Thickness	Polished ID/OD 304 Stainless Steel Part #	Polished ID/OD 316L Stainless Steel Part #
	A	B	C			
1" x ½"	2.000"	1.000"	.500"	.065"	---	<b>B32W-R10050P</b>
2" x 1"	4.000"	2.000"	1.000"	.065"	<b>B32W-G200100P</b>	<b>B32W-R200100P</b>
2" x 1½"	2.000"	2.000"	1.500"	.065"	<b>B32W-G200150P</b>	<b>B32W-R200150P</b>
2½" x 2"	2.000"	2.500"	2.000"	.065"	<b>B32W-G250200P</b>	<b>B32W-R250200P</b>
3" x 2"	4.000"	3.000"	2.000"	.065"	<b>B32W-G300200P</b>	<b>B32W-R300200P</b>
3" x 2½"	2.000"	3.000"	2.500"	.065"	<b>B32W-G300250P</b>	<b>B32W-R300250P</b>
4" x 2"	8.000"	4.000"	2.000"	.083"	<b>B32W-G400200P</b>	<b>B32W-R400200P</b>
4" x 3"	4.000"	4.000"	3.000"	.083"	<b>B32W-G400300P</b>	<b>B32W-R400300P</b>

Polished Weld Crosses

Crosses - B9WWWW

Tube OD	Dimensions		Wall Thickness	Polished ID/OD	Polished ID/OD
	A	B		304 Stainless Steel Part #	316L Stainless Steel Part #
1½"	3.312"	1.656"	.065"	<b>B9WWWW-G150P</b>	<b>B9WWWW-R150P</b>
2"	4.125"	2.062"	.065"	<b>B9WWWW-G200P</b>	<b>B9WWWW-R200P</b>
3"	5.187"	2.593"	.065"	<b>B9WWWW-G300P</b>	<b>B9WWWW-R300P</b>
4"	6.875"	3.437"	.083"	<b>B9WWWW-G400P</b>	<b>B9WWWW-R400P</b>

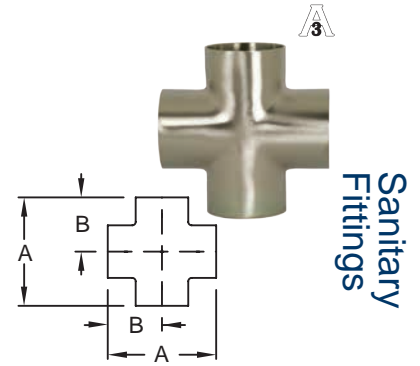

Sanitary Fittings

Miscellaneous Polished Weld Configurations

Laterals - B28WA

Tube OD	Dimensions			Wall Thickness	Polished ID/OD
	A	B	R		316L Stainless Steel Part #
1"	6.000"	1.000"	5.000"	.065"	<b>B28WA-R100P</b>
1½"	7.375"	1.188"	6.188"	.065"	<b>B28WA-R150P</b>
2"	8.750"	1.625"	7.125"	.065"	<b>B28WA-R200P</b>
2½"	10.000"	1.500"	8.500"	.065"	<b>B28WA-R250P</b>
3"	10.750"	1.875"	8.875"	.065"	<b>B28WA-R300P</b>
4"	12.812"	2.015"	10.750"	.083"	<b>B28WA-R400P</b>

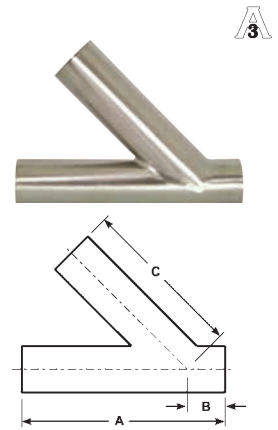

True Wyes - B28W

Tube OD	Dimensions		Wall Thickness	Polished ID/OD
	A	B		316L Stainless Steel Part #
1"	2.000"	2.438"	.065"	<b>B28W-R100P</b>
1½"	2.000"	2.438"	.065"	<b>B28W-R150P</b>
2"	2.625"	3.250"	.065"	<b>B28W-R200P</b>
2½"	3.370"	4.125"	.065"	<b>B28W-R250P</b>
3"	4.000"	4.875"	.065"	<b>B28W-R300P</b>
4"	5.375"	5.375"	.083"	<b>B28W-R400P</b>

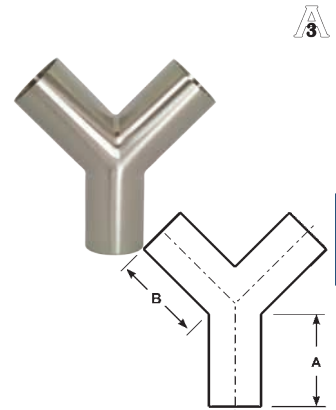

180° Return Bends - B2WUL

Feature:

- bends are standard 1.5 x tube diameter

Tube OD	Dimensions		Polished ID/OD
	A	B	316L Stainless Steel Part #
1"	3.000"	2.000"	<b>B2WUL-R100P</b>
1½"	4.500"	3.000"	<b>B2WUL-R150P</b>
2"	6.000"	4.000"	<b>B2WUL-R200P</b>
2½"	7.500"	5.000"	<b>B2WUL-R250P</b>
3"	9.000"	6.000"	<b>B2WUL-R300P</b>
4"	12.000"	8.000"	<b>B2WUL-R400P</b>

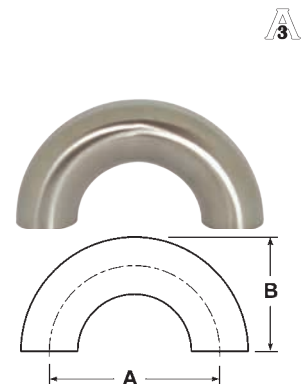

Weld End Blue Protection Covers - BCW

Feature:

- Use these covers to protect all weld ends on fittings and valves.

Sanitary Fittings



Size	Vinyl Plastic Part #
1/2"	<b>BCW-050</b>
3/4"	<b>BCW-075</b>
1"	<b>BCW-100</b>
1 1/2"	<b>BCW-150</b>
2"	<b>BCW-200</b>
2 1/2"	<b>BCW-250</b>
3"	<b>BCW-300</b>
4"	<b>BCW-400</b>
6"	<b>BCW-600</b>
8"	<b>BCW-800</b>

Unpolished Elbows

90° Weld with Tangents - B2S

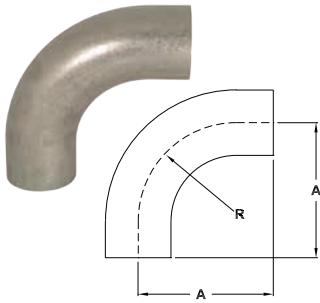

Tube OD	Dimensions		Wall Thickness	Unpolished 304 Stainless Steel Part #	Unpolished 316L Stainless Steel Part #
	A	R			
3/4"	3.000"	1.125"	.065"	---	<b>B2S-R75U</b>
1"	2.062"	1.500"	.065"	<b>B2S-G100U</b>	<b>B2S-R100U</b>
1 1/2"	2.937"	2.250"	.065"	<b>B2S-G150U</b>	<b>B2S-R150U</b>
2"	4.062"	3.000"	.065"	<b>B2S-G200U</b>	<b>B2S-R200U</b>
2 1/2"	5.187"	3.750"	.065"	<b>B2S-G250U</b>	<b>B2S-R250U</b>
3"	6.312"	4.500"	.065"	<b>B2S-G300U</b>	<b>B2S-R300U</b>
4"	8.312"	6.000"	.083"	<b>B2S-G400U</b>	<b>B2S-R400U</b>

90° Weld - B2WCL

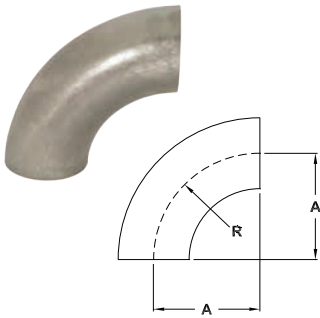

Tube OD	Dimensions		Wall Thickness	Unpolished 304 Stainless Steel Part #	Unpolished 316L Stainless Steel Part #
	A	R			
1/2"	1.125"	1.125"	.065"	---	<b>B2WCL-R50U</b>
3/4"	1.125"	1.125"	.065"	---	<b>B2WCL-R75U</b>
1"	1.500"	1.500"	.065"	<b>B2WCL-G100U</b>	<b>B2WCL-R100U</b>
1 1/2"	2.250"	2.250"	.065"	<b>B2WCL-G150U</b>	<b>B2WCL-R150U</b>
2"	3.000"	3.000"	.065"	<b>B2WCL-G200U</b>	<b>B2WCL-R200U</b>
2 1/2"	3.750"	3.750"	.065"	<b>B2WCL-G250U</b>	<b>B2WCL-R250U</b>
3"	4.500"	4.500"	.065"	<b>B2WCL-G300U</b>	<b>B2WCL-R300U</b>
4"	6.000"	6.000"	.083"	<b>B2WCL-G400U</b>	<b>B2WCL-R400U</b>
6"	9.000"	9.000"	.109"	<b>B2WCL-G600U</b>	<b>B2WCL-R600U</b>
8"	12.000"	12.000"	.109"	<b>B2WCL-G800U</b>	<b>B2WCL-R800U</b>

45° Long Weld with Tangents - B2KS

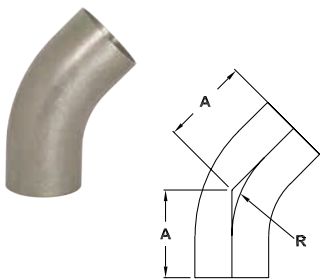

Tube OD	Dimensions		Wall Thickness	Unpolished 304 Stainless Steel Part #	Unpolished 316L Stainless Steel Part #
	A	R			
3/4"	2.250"	1.125"	.065"	---	<b>B2KS-R75U</b>
1"	1.188"	1.500"	.065"	<b>B2KS-G100U</b>	<b>B2KS-R100U</b>
1 1/2"	1.625"	2.250"	.065"	<b>B2KS-G150U</b>	<b>B2KS-R150U</b>
2"	2.312"	3.000"	.065"	<b>B2KS-G200U</b>	<b>B2KS-R200U</b>
2 1/2"	3.000"	3.750"	.065"	<b>B2KS-G250U</b>	<b>B2KS-R250U</b>
3"	3.688"	4.500"	.065"	<b>B2KS-G300U</b>	<b>B2KS-R300U</b>
4"	4.812"	6.000"	.083"	<b>B2KS-G400U</b>	<b>B2KS-R400U</b>

## Unpolished Elbows

45° Weld - B2WK

Tube OD	Dimensions		Wall Thickness	Unpolished	Unpolished
	A	R		304 Stainless Steel Part #	316L Stainless Steel Part #
¾"	.466"	1.125"	.065"	---	<b>B2WK-R75U</b>
1"	.625"	1.500"	.065"	<b>B2WK-G100U</b>	<b>B2WK-R100U</b>
1½"	.937"	2.250"	.065"	<b>B2WK-G150U</b>	<b>B2WK-R150U</b>
2"	1.250"	3.000"	.065"	<b>B2WK-G200U</b>	<b>B2WK-R200U</b>
2½"	1.562"	3.750"	.065"	<b>B2WK-G250U</b>	<b>B2WK-R250U</b>
3"	1.875"	4.500"	.065"	<b>B2WK-G300U</b>	<b>B2WK-R300U</b>
4"	2.500"	6.000"	.083"	<b>B2WK-G400U</b>	<b>B2WK-R400U</b>
6"	3.750"	9.000"	.109"	<b>B2WK-G600U</b>	<b>B2WK-R600U</b>
8"	5.000"	12.000"	.109"	<b>B2WK-G800U</b>	<b>B2WK-R800U</b>

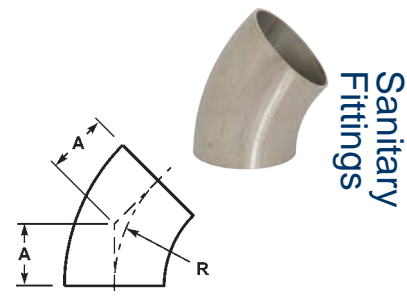

Sanitary Fittings

## Unpolished End Caps - B16W

Tube OD	Dimension A	Unpolished 304 Stainless Steel Part #
1"	.375"	<b>B16W-G100</b>
1½"	.562"	<b>B16W-G150</b>
2"	.750"	<b>B16W-G200</b>
2½"	1.000"	<b>B16W-G250</b>
3"	1.250"	<b>B16W-G300</b>
4"	1.500"	<b>B16W-G400</b>

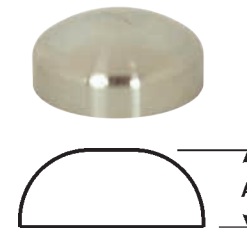

## Unpolished Adapters

Male NPT x Weld End - B19WB

Tube OD	Dimension A	Wall Thickness	304 Stainless Steel Part #
1"	1.750"	.065"	<b>B19WB-G100</b>
1½"	1.750"	.065"	<b>B19WB-G150</b>
2"	1.812"	.065"	<b>B19WB-G200</b>
2½"	2.312"	.065"	<b>B19WB-G250</b>
3"	2.500"	.065"	<b>B19WB-G300</b>
4"	2.562"	.083"	<b>B19WB-G400</b>

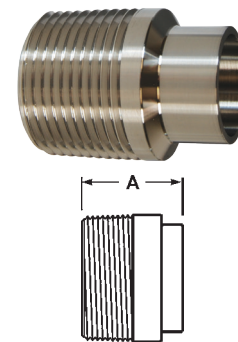

Female NPT x Weld End - B22WB

Tube OD	Dimension A	Wall Thickness	304 Stainless Steel Part #
1"	1.750"	.065"	<b>B22WB-G100</b>
1½"	1.750"	.065"	<b>B22WB-G150</b>
2"	1.812"	.065"	<b>B22WB-G200</b>
2½"	2.312"	.065"	<b>B22WB-G250</b>
3"	2.500"	.065"	<b>B22WB-G300</b>
4"	2.500"	.083"	<b>B22WB-G400</b>

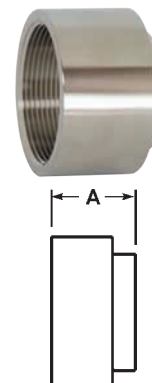

Unpolished Tees

Short Weld - B7WWW

Sanitary Fittings

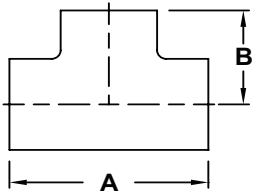

Tube OD	Dimensions		Wall Thickness	Unpolished 304 Stainless Steel Part #	Unpolished 316L Stainless Steel Part #
	A	B			
1"	2.250"	1.125"	.065"	<b>B7WWW-G100U</b>	<b>B7WWW-R100U</b>
1½"	3.312"	1.656"	.065"	<b>B7WWW-G150U</b>	<b>B7WWW-R150U</b>
2"	4.124"	2.062"	.065"	<b>B7WWW-G200U</b>	<b>B7WWW-R200U</b>
2½"	4.688"	2.344"	.065"	<b>B7WWW-G250U</b>	<b>B7WWW-R250U</b>
3"	5.188"	2.594"	.065"	<b>B7WWW-G300U</b>	<b>B7WWW-R300U</b>
4"	6.876"	3.438"	.083"	<b>B7WWW-G400U</b>	<b>B7WWW-R400U</b>

Long Weld - B7W

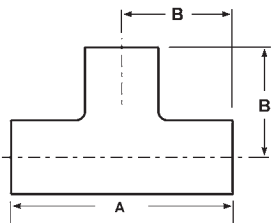

Tube OD	Dimensions		Wall Thickness	Unpolished 304 Stainless Steel Part #	Unpolished 316L Stainless Steel Part #
	A	B			
¾"	4.000"	2.000"	.065"	---	<b>B7W-R75U</b>
1"	3.750"	1.875"	.065"	<b>B7W-G100U</b>	<b>B7W-R100U</b>
1½"	4.500"	2.250"	.065"	<b>B7W-G150U</b>	<b>B7W-R150U</b>
2"	6.000"	3.000"	.065"	<b>B7W-G200U</b>	<b>B7W-R200U</b>
2½"	6.000"	3.000"	.065"	<b>B7W-G250U</b>	<b>B7W-R250U</b>
3"	6.500"	3.250"	.065"	<b>B7W-G300U</b>	<b>B7W-R300U</b>
4"	7.750"	3.875"	.083"	<b>B7W-G400U</b>	<b>B7W-R400U</b>

Reducing Weld - B7RWWW

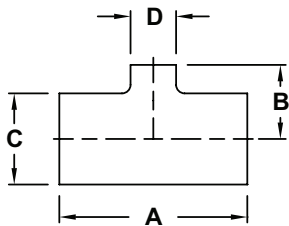

Tube OD	Dimensions				Wall Thickness	Unpolished 304 Stainless Steel Part #	Unpolished 316L Stainless Steel Part #
	A	B	C	D			
1½" x 1"	3.312"	1.375"	1.500"	1.000"	.065"	<b>B7RWWW-G150100U</b>	<b>B7RWWW-R150100U</b>
2" x 1"	4.124"	1.625"	2.000"	1.000"	.065"	<b>B7RWWW-G200100U</b>	<b>B7RWWW-R200100U</b>
2" x 1½"	4.124"	1.906"	2.000"	1.500"	.065"	<b>B7RWWW-G200150U</b>	<b>B7RWWW-R200150U</b>
2½" x 1½"	4.688"	2.156"	2.500"	1.500"	.065"	<b>B7RWWW-G250150U</b>	<b>B7RWWW-R250150U</b>
2½" x 2"	4.688"	2.312"	2.500"	2.000"	.065"	<b>B7RWWW-G250200U</b>	<b>B7RWWW-R250200U</b>
3" x 1½"	5.188"	2.406"	3.000"	1.500"	.065"	<b>B7RWWW-G300150U</b>	<b>B7RWWW-R300150U</b>
3" x 2"	5.188"	2.562"	3.000"	2.000"	.065"	<b>B7RWWW-G300200U</b>	<b>B7RWWW-R300200U</b>
4" x 2"	6.876"	3.062"	4.000"	2.000"	.083"	<b>B7RWWW-G400200U</b>	<b>B7RWWW-R400200U</b>
4" x 3"	6.876"	3.094"	4.000"	3.000"	.083"	<b>B7RWWW-G400300U</b>	<b>B7RWWW-R400300U</b>



## Unpolished Weld Reducers

### Concentric - B31W

Tube OD	Dimension A	Wall Thickness	Unpolished 304 Stainless Steel Part #	Unpolished 316L Stainless Steel Part #
¾" x ½"	1.000"	.065"	---	<b>B31W-R7550U</b>
1" x ½"	2.000"	.065"	---	<b>B31W-R10050U</b>
1" x ¾"	1.000"	.065"	---	<b>B31W-R10075U</b>
1½" x ¾"	3.000"	.065"	---	<b>B31W-R15075U</b>
1½" x 1"	2.000"	.065"	<b>B31W-G150100U</b>	<b>B31W-R150100U</b>
2" x 1"	4.000"	.065"	<b>B31W-G200100U</b>	<b>B31W-R200100U</b>
2" x 1½"	2.000"	.065"	<b>B31W-G200150U</b>	<b>B31W-R200150U</b>
2½" x 1½"	4.000"	.065"	<b>B31W-G250150U</b>	<b>B31W-R250150U</b>
2½" x 2"	2.000"	.065"	<b>B31W-G250200U</b>	<b>B31W-R250200U</b>
3" x 1½"	6.000"	.065"	<b>B31W-G300150U</b>	<b>B31W-R300150U</b>
3" x 2"	4.000"	.065"	<b>B31W-G300200U</b>	<b>B31W-R300200U</b>
3" x 2½"	2.000"	.065"	<b>B31W-G300250U</b>	<b>B31W-R300250U</b>
4" x 2"	8.000"	.083"	<b>B31W-G400200U</b>	<b>B31W-R400200U</b>
4" x 2½"	6.000"	.083"	<b>B31W-G400250U</b>	<b>B31W-R400250U</b>
4" x 3"	4.000"	.083"	<b>B31W-G400300U</b>	<b>B31W-R400300U</b>
6" x 4"	5.500"	.109"	<b>B31W-G600400U</b>	<b>B31W-R600400U</b>

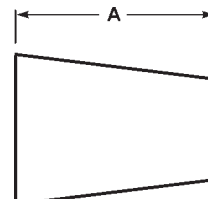

Sanitary Fittings

### Eccentric - B32W

Tube OD	Dimension A	Wall Thickness	Unpolished 304 Stainless Steel Part #	Unpolished 316L Stainless Steel Part #
1" x ½"	2.000"	.065"	---	<b>B32W-R10050U</b>
2" x 1"	4.000"	.065"	<b>B32W-G200100U</b>	<b>B32W-R200100U</b>
2" x 1½"	2.000"	.065"	<b>B32W-G200150U</b>	<b>B32W-R200150U</b>
2½" x 2"	2.000"	.065"	<b>B32W-G250200U</b>	<b>B32W-R250200U</b>
3" x 2"	4.000"	.065"	<b>B32W-G300200U</b>	<b>B32W-R300200U</b>
3" x 2½"	2.000"	.065"	<b>B32W-G300250U</b>	<b>B32W-R300250U</b>
4" x 2"	8.000"	.083"	<b>B32W-G400200U</b>	<b>B32W-R400200U</b>
4" x 3"	4.000"	.083"	<b>B32W-G400300U</b>	<b>B32W-R400300U</b>

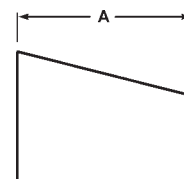
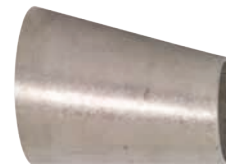

## Unpolished Type A Stub Ends - 14VB

### Application:

- typically used with B38SL flanges

Tube OD	Dimensions				316L Stainless Steel Part #
	A	B	C	D	
1"	1.625"	2.000"	1.000"	.065"	<b>14VB-R100</b>
1½"	1.750"	2.875"	1.500"	.065"	<b>14VB-R150</b>
2"	1.500"	3.625"	2.000"	.065"	<b>14VB-R200</b>
2½"	2.000"	4.125"	2.500"	.065"	<b>14VB-R250</b>
3"	2.250"	5.000"	3.000"	.065"	<b>14VB-R300</b>
4"	2.625"	6.187"	4.000"	.083"	<b>14VB-R400</b>
6"	3.000"	8.500"	6.000"	.109"	<b>14VB-R600</b>
8"	3.000"	10.625"	8.000"	.109"	<b>14VB-R800</b>

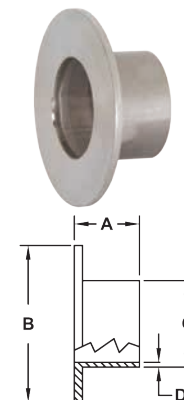

**Unpolished Miscellaneous Configurations**

Sanitary  
Fittings

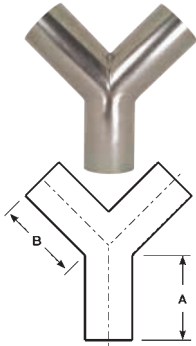

**Weld True Wyes - B28W**

Tube OD	Dimensions		Wall Thickness	Unpolished 316L Stainless Steel Part #
	A	B		
1"	2.000"	2.438"	.065"	<b>B28W-R100U</b>
1½"	2.000"	2.438"	.065"	<b>B28W-R150U</b>
2"	2.625"	3.250"	.065"	<b>B28W-R200U</b>
2½"	3.370"	4.125"	.065"	<b>B28W-R250U</b>
3"	4.000"	4.875"	.065"	<b>B28W-R300U</b>
4"	5.375"	5.375"	.083"	<b>B28W-R400U</b>

**Weld Laterals - B28WA**

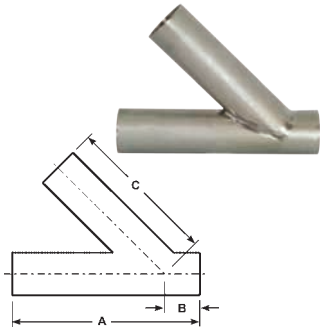

Tube OD	Dimensions			Wall Thickness	Unpolished 316L Stainless Steel Part #
	A	B	R		
1"	6.000"	1.000"	5.000"	.065"	<b>B28WA-R100U</b>
1½"	7.375"	1.188"	6.188"	.065"	<b>B28WA-R150U</b>
2"	8.750"	1.625"	7.125"	.065"	<b>B28WA-R200U</b>
2½"	10.000"	1.500"	8.500"	.065"	<b>B28WA-R250U</b>
3"	10.750"	1.875"	8.875"	.065"	<b>B28WA-R300U</b>
4"	12.812"	2.015"	10.750"	.083"	<b>B28WA-R400U</b>

**Weld 180° Return Bends - B2WUL**

**Feature:**

- bends are standard 1.5 x tube diameter

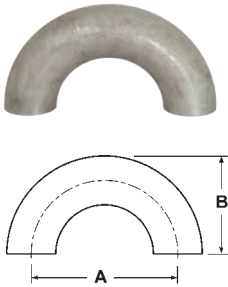

Tube OD	Dimensions		Wall Thickness	Unpolished 316L Stainless Steel Part #
	A	B		
1"	3.000"	2.000"	.065"	<b>B2WUL-R100U</b>
1½"	4.500"	3.000"	.065"	<b>B2WUL-R150U</b>
2"	6.000"	4.000"	.065"	<b>B2WUL-R200U</b>
3"	9.000"	6.000"	.065"	<b>B2WUL-R300U</b>
4"	12.000"	8.000"	.083"	<b>B2WUL-R400U</b>

See page 610 for weld end protection covers.



## Unpolished - Flanges

## Slip-On 150# - B38SL

Tube OD	Dimensions			Number / Diameter Bolt Holes	Bolt Circle	304 Stainless Steel	316L Stainless Steel
	A	B	C			Part #	Part #
1"	.375"	4.250"	1.063"	4/.625"	3.125"	<b>B38SL-G100</b>	<b>B38SL-R100</b>
1½"	.375"	5.000"	1.563"	4/.625"	3.875"	<b>B38SL-G150</b>	<b>B38SL-R150</b>
2"	.437"	6.000"	2.063"	4/.750"	4.750"	<b>B38SL-G200</b>	<b>B38SL-R200</b>
3"	.500"	7.500"	3.063"	4/.750"	6.000"	<b>B38SL-G300</b>	<b>B38SL-R300</b>
4"	.562"	9.000"	4.063"	8/.750"	7.500"	<b>B38SL-G400</b>	<b>B38SL-R400</b>
6"	.562"	11.000"	6.063"	8/.875"	9.500"	<b>B38SL-G600</b>	<b>B38SL-R600</b>
8"	.562"	13.500"	8.063"	8/.875"	11.750"	<b>B38SL-G800</b>	<b>B38SL-R800</b>

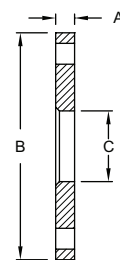

Sanitary Fittings

## Weld Neck - B38W

Tube OD	Dimensions				Number / Diameter Bolt Holes	Bolt Circle	316L Stainless Steel
	A	B	C	D			Part #
1"	.375"	4.250"	1.000"	.500"	4/.625"	3.125"	<b>B38W-R100</b>
1½"	.375"	5.000"	1.500"	.500"	4/.625"	3.875"	<b>B38W-R150</b>
2"	.500"	6.000"	2.000"	.625"	4/.750"	4.750"	<b>B38W-R200</b>
2½"	.500"	7.000"	2.500"	.625"	4/.750"	5.500"	<b>B38W-R250</b>
3"	.500"	7.500"	3.000"	.625"	4/.750"	6.000"	<b>B38W-R300</b>
4"	.500"	9.000"	4.000"	.625"	8/.750"	7.500"	<b>B38W-R400</b>
6"	.500"	11.000"	6.000"	.625"	8/.875"	9.500"	<b>B38W-R600</b>
8"	.500"	13.500"	8.000"	.625"	8/.875"	11.750"	<b>B38W-R800</b>

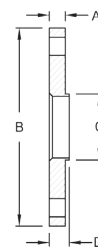

- For flange dimensions, diagrams and additional information please reference [dixonvalve.com](http://dixonvalve.com).

Spray Balls

Rotating - SRH

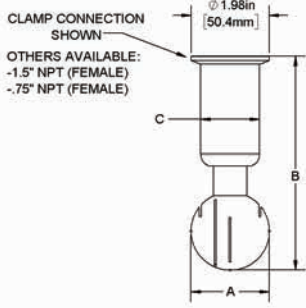

**Application:**

- ideal for cleaning all types of tanks and vessels

**Features:**

- stainless steel ball bearings eliminate rust
- cleaning solution lubricates unit
- mirror-like finish (OD)
- spray pattern: 360°
- available connections: clamp and NPT

Size	Type	304 Stainless Steel Part #	316L Stainless Steel Part #
3/4"	NPT	<b>SRH360NPT-G075</b>	---
1 1/2"	NPT	---	<b>SRH360NPT-R150</b>
1 1/2"	clamp	<b>SRH360CMP-G150</b>	<b>SRH360CMP-R150</b>

Stationary - STC

**Application:**

- typically used in food and beverage industries for cleaning storage tanks

**Features:**

- heavy duty 316L stainless steel construction provides longer life
- stationary - designed to be mounted to a tube or pipe
- 2 mm spray holes
- various spray patterns available (blanks available as special order)

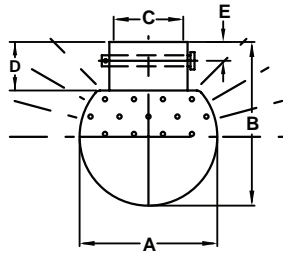

180° Top Pattern

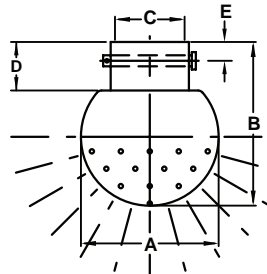

180° Bottom Pattern

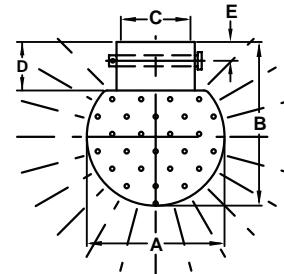

360° Pattern

Size	Pin Length	Spray Pattern	Dimensions					Pin Size	316L Stainless Steel Part #
			A	B	C	D	E		
1"	1.47"	360°	2.50"	3.04"	1.005"	.975"	.445"	.226"	<b>STC-360-R100</b>
1 1/2"	1.95"	360°	2.95"	3.55"	1.505"	1.050"	.445"	.226"	<b>STC-360-R150</b>
1"	1.47"	180° bottom	3.54"	2.95"	1.005"	.975"	.445"	.226"	<b>STC-180B-R100</b>
1 1/2"	1.95"	180° bottom	3.54"	2.95"	1.505"	.975"	.445"	.226"	<b>STC-180B-R150</b>
1"	1.47"	180° top	3.54"	2.95"	1.005"	.975"	.445"	.226"	<b>STC-180T-R100</b>
1 1/2"	1.95"	180° top	3.54"	2.95"	1.505"	.975"	.445"	.226"	<b>STC-180T-R150</b>

Repair Kits

Repair kit contains:

- (1) pin
- (1) R clip

Size	Part #
1"	<b>STC-RK100</b>
1 1/2"	<b>STC-RK150</b>



Sight Glasses

Features:

- 1" - 6" OD tube
- body: 316L stainless steel
- sight glass: Borosilicate glass or polycarbonate
- gaskets: white Buna or FKM
- 32R<sub>a</sub> sanitary finish, ID and OD

In-line - B54BMP

Features:

- various end configurations are available: clamp, weld, bevel seat, John Perry, I-Line and Q-Line
- maximum temperature: **200°F (93°C)**

Tube OD	A	B	Working Pressure (PSI)	316L Stainless Steel Borosilicate Glass Part Number	316 Stainless Steel Polycarbonate Part Number
1"	5.625"	3.250"	145	<b>B54BMP-R100</b>	<b>B54BMP-R100LX</b>
1½"	5.625"	4.000"	145	<b>B54BMP-R150</b>	<b>B54BMP-R150LX</b>
2"	5.625"	4.250"	145	<b>B54BMP-R200</b>	<b>B54BMP-R200LX</b>
2½"	6.125"	4.750"	120	<b>B54BMP-R250</b>	<b>B54BMP-R250LX</b>
3"	7.250"	5.500"	120	<b>B54BMP-R300</b>	<b>B54BMP-R300LX</b>
4"	7.375"	6.500"	95	<b>B54BMP-R400</b>	<b>B54BMP-R400LX</b>
6"	7.625"	9.500"	80	<b>B54BMP-R600</b>	<b>B54BMP-R600LX</b>

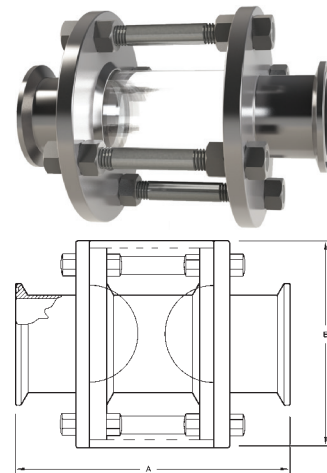

Sanitary Fittings

Kits and Replacement Parts

Size	Buna Seal Kit Part Number	FKM Seal Kit Part Number	Borosilicate Glass Replacement Part Number	Polycarbonate Replacement Part Number
1"	<b>B54BMP-SK100</b>	<b>B54BMP-VK100</b>	<b>B54G-P100</b>	<b>B54BMP-LX100</b>
1½"	<b>B54BMP-SK150</b>	<b>B54BMP-VK150</b>	<b>B54G-P150</b>	<b>B54BMP-LX150</b>
2"	<b>B54BMP-SK200</b>	<b>B54BMP-VK200</b>	<b>B54G-P200</b>	<b>B54BMP-LX200</b>
2½"	<b>B54BMP-SK250</b>	<b>B54BMP-VK250</b>	<b>B54G-P250</b>	<b>B54BMP-LX250</b>
3"	<b>B54BMP-SK300</b>	<b>B54BMP-VK300</b>	<b>B54G-P300</b>	<b>B54BMP-LX300</b>
4"	<b>B54BMP-SK400</b>	<b>B54BMP-VK400</b>	<b>B54G-P400</b>	<b>B54BMP-LX400</b>
6"	<b>B54BMP-SK600</b>	<b>B54BMP-VK600</b>	<b>B54G-P600</b>	<b>B54BMP-LX600</b>

Seal kit contains: (2) white Buna gaskets

End Caps - B5416MP

Feature:

- for use on any line with a clamp and gasket
- maximum temperature: **150°F (66°C)**
- maximum operating pressure: **100 PSI**

Tube OD	A	B	Acrylic Plastic Part Number
1" - 1½"	.438"	1.984"	<b>B5416MP-A100150</b>
2"	.438"	2.516"	<b>B5416MP-A200</b>
2½"	.438"	3.047"	<b>B5416MP-A250</b>
3"	.438"	3.579"	<b>B5416MP-A300</b>
4"	.438"	4.682"	<b>B5416MP-A400</b>
6"	.438"	6.562"	<b>B5416MP-A600</b>

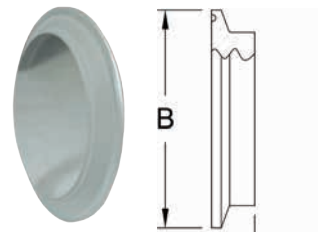

Compact Sight Glasses

**Applications:**

- Used widely in the food, dairy and beverage sanitary processes to view products and fluids.

**Features:**

- design perfect for hoses
- easier to clean than bolted styles
- less cost to repair than bolted styles
- clamp connections standard

Sanitary Fittings

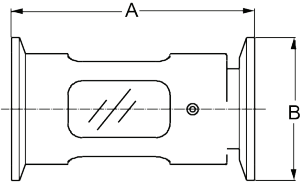

Tube OD	Dimensions		316 Stainless Steel Polycarbonate Part #	316 Stainless Steel Borosilicate Glass Part #
	A	B		
1"	3.375"	1.985"	<b>B54BMPLX-R100</b>	<b>B54BMPS-R100</b>
1½"	3.640"	1.985"	<b>B54BMPLX-R150</b>	<b>B54BMPS-R150</b>
2"	3.830"	2.516"	<b>B54BMPLX-R200</b>	<b>B54BMPS-R200</b>
3"	4.130"	3.579"	<b>B54BMPLX-R300</b>	<b>B54BMPS-R300</b>
4"	4.340"	4.682"	<b>B54BMPLX-R400</b>	<b>B54BMPS-R400</b>

Seal Kits



Size	Buna Seal Kit Part Number	FKM Seal Kit Part Number
1"	<b>B54BMP-SK100</b>	<b>B54BMP-VK100</b>
1½"	<b>B54BMP-SK150</b>	<b>B54BMP-VK150</b>
2"	<b>B54BMP-SK200</b>	<b>B54BMP-VK200</b>
3"	<b>B54BMP-SK300</b>	<b>B54BMP-VK300</b>
4"	<b>B54BMP-SK400</b>	<b>B54BMP-VK400</b>

Replacement Glasses



Size	Polycarbonate Replacement Part Number	Borosilicate Glass Replacement Part Number
1"	<b>B54BMP-LX100</b>	<b>B54BMP-GL100</b>
1½"	<b>B54BMP-LX150</b>	<b>B54BMP-GL150</b>
2"	<b>B54BMP-LX200</b>	<b>B54BMP-GL200</b>
3"	<b>B54BMP-LX300</b>	<b>B54BMP-GL300</b>
4"	<b>B54BMP-LX400</b>	<b>B54BMP-GL400</b>

Swivels

Features:

- available in clamp and weld configurations
- elastomers: silicone and PTFE standard, optional elastomers available
- finish: sanitary finish ID and OD

straight clamp - style 20

Size	Dimensions			Pressure Rating PSI @ 70°F (21°C)	Pressure Rating PSI @ 250°F (121°C)	316L Stainless Steel Part #
	A	B	C			
1"	2.56"	3.00"	1.00"	500	300	<i>SJSS100CC-20</i>
1½"	2.56"	3.00"	1.50"	500	300	<i>SJSS150CC-20</i>
2"	3.09"	3.00"	2.00"	450	250	<i>SJSS200CC-20</i>
2½"	3.44"	3.00"	2.50"	400	200	<i>SJSS250CC-20</i>
3"	3.94"	3.00"	3.00"	350	175	<i>SJSS300CC-20</i>
4"	5.08"	4.19"	4.00"	300	150	<i>SJSS400CC-20</i>



Sanitary  
Fittings

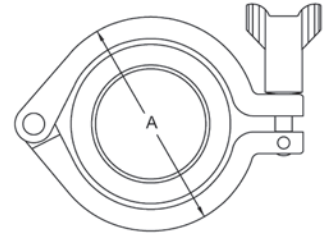

straight weld connection - style 20

Size	Dimensions			Pressure Rating PSI @ 70°F (21°C)	Pressure Rating PSI @ 250°F (121°C)	316L Stainless Steel Part #
	A	B	C			
1"	2.56"	2.00"	1.00"	500	300	<i>SJSS100BB-20</i>
1½"	2.56"	2.00"	1.50"	500	300	<i>SJSS150BB-20</i>
2"	3.09"	2.00"	2.00"	450	250	<i>SJSS200BB-20</i>
2½"	3.44"	2.00"	2.50"	400	200	<i>SJSS250BB-20</i>
3"	3.94"	2.00"	3.00"	350	175	<i>SJSS300BB-20</i>
4"	5.08"	2.94"	4.00"	300	150	<i>SJSS400BB-20</i>

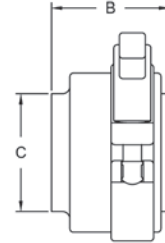

- dimensional information can be found at [dixonvalve.com](http://dixonvalve.com)

Configurations

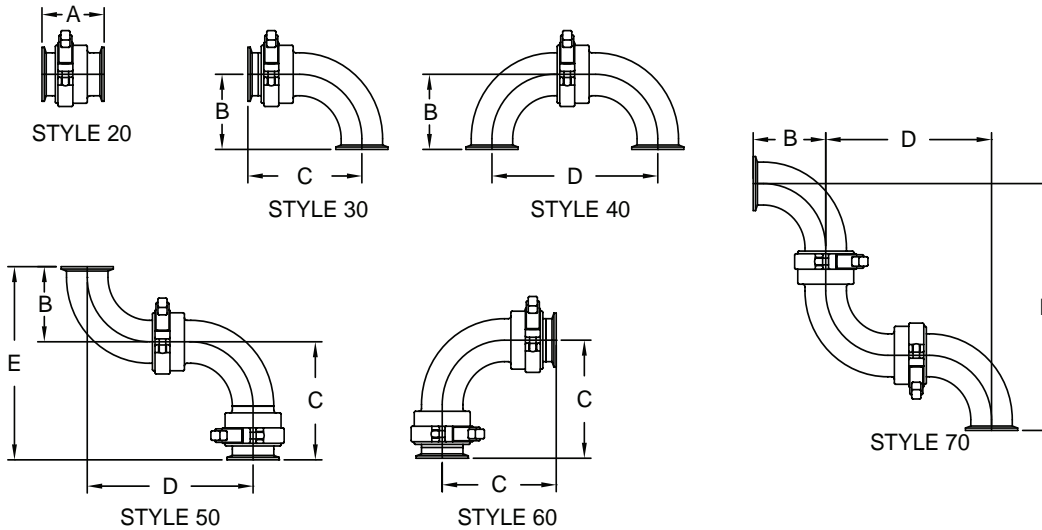

Clamp Joint Dimensions

Size	A	B	C	D	E	F	Part Number
1"	3.00"	2.00"	4.00"	5.00"	6.00"	7.00"	<i>SJSS100CC-*</i>
1½"	3.00"	2.75"	4.75"	6.50"	7.50"	9.25"	<i>SJSS150CC-*</i>
2"	3.00"	3.50"	5.50"	8.00"	9.00"	11.50"	<i>SJSS200CC-*</i>
2½"	3.00"	4.25"	6.25"	9.50"	10.50"	13.75"	<i>SJSS250CC-*</i>
3"	3.00"	5.00"	7.00"	11.00"	12.00"	16.00"	<i>SJSS300CC-*</i>
4"	5.19"	6.63"	9.63"	14.94"	15.94"	21.56"	<i>SJSS400CC-*</i>

\* For all other styles, please contact Dixon Sanitary 800.789.1718

Sanitary 3½" Pressure Gauges

Features:

- accuracy: ± 1.5% of full scale
- over range capacity: 30%
- wetted surfaces: 316L stainless steel
- surface finishes (wetted parts): R<sub>a</sub> max = 25 microinches
- case material: 304 stainless steel
- dial size: 3½"
- lens material: polycarbonate
- temperature range: 0°F (-18°C) to 250°F (121°C)
- standard fill: food grade glycerin
- rezero feature: standard on pointer
- shipping weight: approximately 3 lbs. (1.3 kg)

Sanitary Fittings

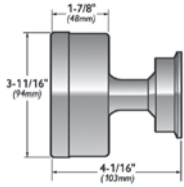
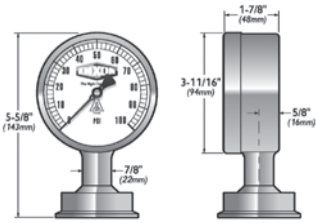

Dial Size	Clamp Size	Pressure Range (PSI)	Mount	316L Stainless Steel Part #
3½"	1½"	0-30	bottom	<b>3S-B-15U-GFBTSS</b>
	1½"	0-60	bottom	<b>3S-C-15U-GFBTSS</b>
	1½"	0-100	bottom	<b>3S-D-15U-GFBTSS</b>
	1½"	0-160	bottom	<b>3S-E-15U-GFBTSS</b>
	1½"	0-200	bottom	<b>3S-F-15U-GFBTSS</b>
	1½"	0-300	bottom	<b>3S-G-15U-GFBTSS</b>
	1½"	0-30	back	<b>3S-B-15U-GFBKSS</b>
	1½"	0-60	back	<b>3S-C-15U-GFBKSS</b>
	1½"	0-100	back	<b>3S-D-15U-GFBKSS</b>
	1½"	0-160	back	<b>3S-E-15U-GFBKSS</b>
	1½"	0-200	back	<b>3S-F-15U-GFBKSS</b>
	1½"	0-300	back	<b>3S-G-15U-GFBKSS</b>
	2"	0-30	bottom	<b>3S-B-2U-GFBTSS</b>
	2"	0-60	bottom	<b>3S-C-2U-GFBTSS</b>
	2"	0-100	bottom	<b>3S-D-2U-GFBTSS</b>
	2"	0-160	bottom	<b>3S-E-2U-GFBTSS</b>
	2"	0-200	bottom	<b>3S-F-2U-GFBTSS</b>
	2"	0-300	bottom	<b>3S-G-2U-GFBTSS</b>
	2"	0-30	back	<b>3S-B-2U-GFBKSS</b>
	2"	0-60	back	<b>3S-C-2U-GFBKSS</b>
	2"	0-100	back	<b>3S-D-2U-GFBKSS</b>
	2"	0-160	back	<b>3S-E-2U-GFBKSS</b>
	2"	0-200	back	<b>3S-F-2U-GFBKSS</b>
	2"	0-300	back	<b>3S-G-2U-GFBKSS</b>



## Strainers

### In-line - BSCCQ

**Features:**

- ships standard with: spring, distributor cap, clamp gasket, 1/4" perforated back-up tube, squeeze clamp, inlet and outlet bodies
- must be vertically mounted to be 3A compliant
- bevel seat, I-line and weld ends available, call Dixon® for information
- 1/8" perforated back-up tube available, must specify when ordering (not 3A)

**short**

Size	Dimensions		316L Stainless Steel Part #
	A	B	
1"	15.75"	4.00"	<b>BSCCQ1-R100</b>
1½"	15.75"	4.00"	<b>BSCCQ1-R150</b>
2"	15.75"	4.00"	<b>BSCCQ1-R200</b>
2½"	15.75"	4.50"	<b>BSCCS1-R250</b>
3"	15.75"	4.50"	<b>BSCCS1-R300</b>

**long**

Size	Dimensions		316L Stainless Steel Part #
	A	B	
1½"	35.375"	4.00"	<b>BSCCQ2-R150</b>
2"	35.375"	4.00"	<b>BSCCQ2-R200</b>
3"	35.375"	4.50"	<b>BSCCS2-R300</b>



short

Sanitary Fittings

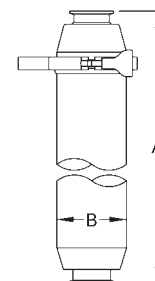

### Side-Entry - BSCCQ

**Features:**

- ships standard with: spring, end cap with handle, distributor cap, clamp gasket, 1/4" perforated back-up tube, body and squeeze clamp
- serviceable without removing from the line
- must be a vertically mounted to be 3A compliant
- bevel seat, I-line and weld ends available, call Dixon® for information
- 1/8" perforated back-up tube available, must specify when ordering (not 3A certified)

Size	Dimensions				316L Stainless Steel Part #
	A	B	C	D	
1½"	41.90"	4.00"	35.00"	3.50"	<b>BSCCQ3-R150</b>
2"	41.90"	4.00"	35.00"	3.50"	<b>BSCCQ3-R200</b>
3"	41.90"	4.50"	35.00"	3.75"	<b>BSCCQ3-R300</b>

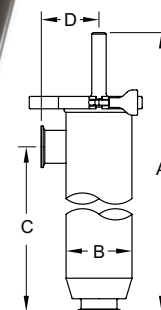
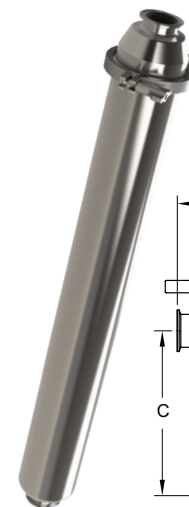

### Side-Outlet Reverse - BSCCQ

**Features:**

- ships standard with: spring, end cap with handle, distributor cap, clamp gasket, 1/4" perforated back-up tube, body and squeeze clamp
- 1/8" perforated back-up tube available (not 3A certified)
- bevel seat, I-line and weld ends available, call Dixon® for information
- can be serviced in-line

Size	Dimensions				316L Stainless Steel Part #
	A	B	C	D	
1½"	41.90"	4.00"	35.00"	3.50"	<b>BSCCQ4-R150</b>
2"	41.90"	4.00"	35.00"	3.50"	<b>BSCCQ4-R200</b>
3"	41.90"	4.50"	35.00"	3.75"	<b>BSCCQ4-R300</b>

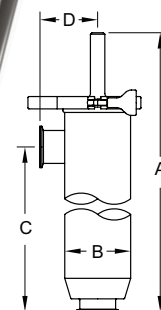
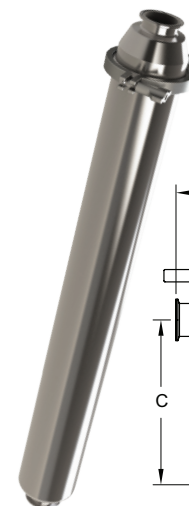

Strainers

Filters

Features:

- filter medium are special order and minimum quantities apply, not included with base unit
- filters require retaining ring

Sanitary Fittings

short

Size	Micron Rating	Description	Part #
1" - 2"	38	nonwoven rayon (glued seam)	<b>BF30A-100-200</b>
2½" - 3"	38	nonwoven rayon (glued seam)	<b>BF30A-250-300</b>
1" - 2"	513	woven knapped cotton flannel	<b>BF30B-100-200</b>
2½" - 3"	513	woven knapped cotton flannel	<b>BF30B-250-300</b>
1" - 2"	300	cheese cloth, single thickness cotton	<b>BF30C-100-200</b>
2½" - 3"	300	cheese cloth, single thickness cotton	<b>BF30C-250-300</b>
1" - 2"	765	nylon, 26/29 mesh, rectangular opening, (.025 x .030)	<b>BF30D-100-200</b>
2½" - 3"	765	nylon, 26/29 mesh, rectangular opening, (.025 x .030)	<b>BF30D-250-300</b>
1" - 2"	40-42	nonwoven rayon	<b>BF30E-100-200</b>
2½" - 3"	40-42	nonwoven rayon	<b>BF30E-250-300</b>
1" - 2"	40	nonwoven rayon	---
1" - 2"	420	woven nylon, 40 mesh	<b>BF30G-100-200</b>
2½" - 3"	420	woven nylon, 40 mesh	<b>BF30G-250-300</b>

long

Size	Micron Rating	Description	Part #
1" - 2"	40-42	nonwoven rayon	<b>BF302E-100-200</b>
2½" - 3"	40-42	nonwoven rayon	<b>BF302E-250-300</b>
2½" - 3"	420	woven nylon, 40 mesh	<b>BF302G-250-300</b>

316 Stainless Wire Cloth Mesh Over Screens

Features:

- not all sizes are stocked, additional sizes are available (5 piece minimum), call Dixon®
- not 3A compatible, not included with base unit

Size	Micron Rating	Square Mesh	Space Between Wires	Percent of Open Area	Short Part #	Long Part #
1" - 2"	864	20	0.034"	46.2	<b>BS20-100-200</b>	<b>BS202-100-200</b>
2½" - 3"	864	20	0.034"	46.2	<b>BS20-250-300</b>	<b>BS202-250-300</b>
1" - 2"	381	40	0.015"	36.0	<b>BS40-100-200</b>	<b>BS402-100-200</b>
2½" - 3"	381	40	0.015"	36.0	<b>BS40-250-300</b>	<b>BS402-250-300</b>
1" - 2"	229	60	0.009"	30.3	<b>BS60-100-200</b>	<b>BS602-100-200</b>
2½" - 3"	229	60	0.009"	30.3	<b>BS60-250-300</b>	<b>BS602-250-300</b>
1" - 2"	178	80	0.007"	31.4	<b>BS80-100-200</b>	<b>BS802-100-200</b>
2½" - 3"	178	80	0.007"	31.4	<b>BS80-250-300</b>	<b>BS802-250-300</b>
1" - 2"	140	100	0.006"	30.3	<b>BS100-100-200</b>	<b>BS1002-100-200</b>
2½" - 3"	140	100	0.006"	30.3	<b>BS100-250-300</b>	<b>BS1002-250-300</b>

Pressure Drop Curves for Filter and Strainer

- water at ambient temperature
- maximum flow for short units is 125 GPM
- maximum flow for long units is 175 GPM

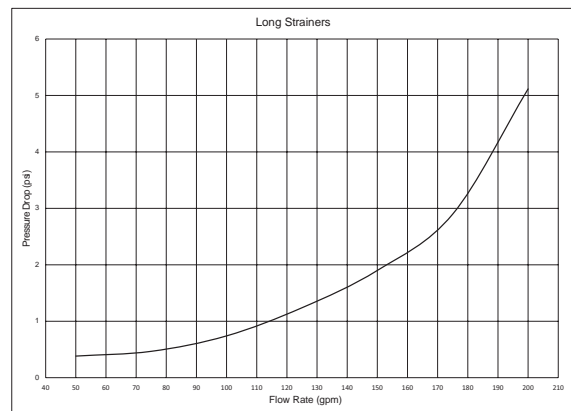
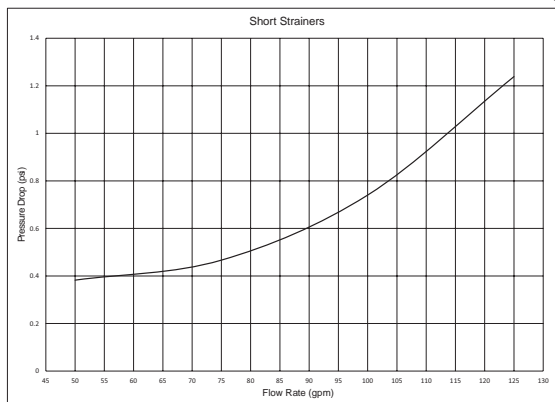





## Tube Hangers

### Hex with ABS Sleeve - B24PS

**Feature:**

- maximum temperature: **230°F (110°C)**

Tube OD	Dimensions		304 Stainless Steel Part #
	A	B	
1/2"	2.800"	1.150"	<b>B24PS-G50</b>
3/4"	2.800"	1.150"	<b>B24PS-G75</b>
1"	3.425"	1.450"	<b>B24PS-G100</b>
1 1/2"	4.000"	2.125"	<b>B24PS-G150</b>
2"	4.500"	2.500"	<b>B24PS-G200</b>
2 1/2"	4.950"	3.125"	<b>B24PS-G250</b>
3"	5.500"	3.750"	<b>B24PS-G300</b>
4"	6.950"	4.750"	<b>B24PS-G400</b>
5"	8.063"	5.625"	<b>B24PS-G500</b>
6"	9.250"	6.625"	<b>B24PS-G600</b>
8"	11.500"	8.625"	<b>B24PS-G800</b>

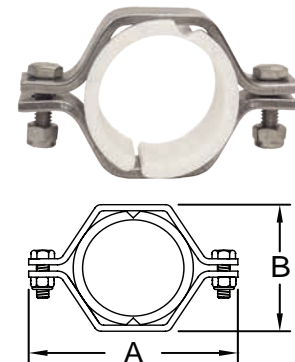

Sanitary Fittings

### Hex with High Temperature Polysulfone Sleeve - B24HS



**Specification:**

- high temperature sleeve maximum temperature: **325°F (163°C)**

Tube OD	Dimensions		304 Stainless Steel Part Number
	A	B	
1/2"	2.375"	1.062"	<b>B24HS-G50</b>
3/4"	2.625"	1.188"	<b>B24HS-G75</b>
1"	2.688"	1.563"	<b>B24HS-G100</b>
1 1/2"	3.625"	2.125"	<b>B24HS-G150</b>
2"	4.625"	2.625"	<b>B24HS-G200</b>
2 1/2"	4.813"	3.125"	<b>B24HS-G250</b>
3"	5.375"	3.625"	<b>B24HS-G300</b>
4"	6.625"	4.625"	<b>B24HS-G400</b>
6"	9.000"	6.625"	<b>B24HS-G600</b>

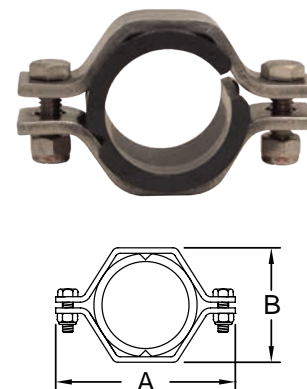

### Sleeves - 13PS

**Features:**

- maximum temperature: **230°F (110°C)**
- high temperature sleeves are also available, contact Dixon®

Size	ABS Part #	High Temperature Part #
1/2"	<b>13PS-50</b>	<b>13HS-50</b>
3/4"	<b>13PS-75</b>	<b>13HS-75</b>
1"	<b>13PS-100</b>	<b>13HS-100</b>
1 1/2"	<b>13PS-150</b>	<b>13HS-150</b>
2"	<b>13PS-200</b>	<b>13HS-200</b>
2 1/2"	<b>13PS-250</b>	<b>13HS-250</b>
3"	<b>13PS-300</b>	<b>13HS-300</b>
4"	<b>13PS-400</b>	<b>13HS-400</b>
5"	<b>13PS-500</b>	---
6"	<b>13PS-600</b>	<b>13HS-600</b>
8"	<b>13PS-800</b>	---



Tube Hangers

Hex with Nitrile Grommets - B24RG

Features:

- replacement grommets are available, contact Dixon®
- nitrile grommets; maximum temperature: 230°F (110°C)

Tube OD	Dimensions		304 Stainless Steel Part #
	A	B	
½" - ¾"	3.425"	1.450"	<b>B24RG-G75</b>
1"	3.425"	1.450"	<b>B24RG-G100</b>
1½"	4.000"	2.125"	<b>B24RG-G150</b>
2"	4.500"	2.500"	<b>B24RG-G200</b>
2½"	4.950"	3.125"	<b>B24RG-G250</b>
3"	5.500"	3.750"	<b>B24RG-G300</b>
4"	6.950"	4.750"	<b>B24RG-G400</b>
5"	8.000"	5.625"	<b>B24RG-G500</b>
6"	9.250"	6.625"	<b>B24RG-G600</b>
8"	11.500"	8.625"	<b>B24RG-G800</b>

Sanitary Fittings

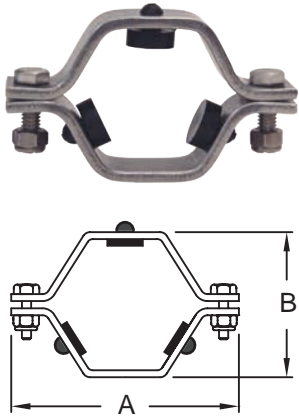

Round with Nitrile Inserts - B24RPH

Feature:

- Nitrile inserts
- maximum temperature: 230°F (110°C)

Tube OD	Dimensions		304 Stainless Steel Part #
	A	B	
½"	2.750"	1.125"	<b>B24RPH-G50</b>
¾"	2.750"	1.125"	<b>B24RPH-G75</b>
1"	3.310"	1.500"	<b>B24RPH-G100</b>
1½"	3.810"	2.000"	<b>B24RPH-G150</b>
2"	4.250"	2.562"	<b>B24RPH-G200</b>
2½"	5.000"	3.000"	<b>B24RPH-G250</b>
3"	5.500"	3.562"	<b>B24RPH-G300</b>
4"	6.500"	4.688"	<b>B24RPH-G400</b>

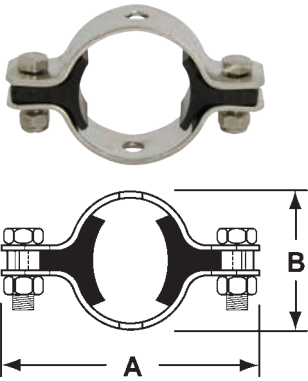

Nuts and Bolts - 13NHN

Features:

- hex hangers with grommets and round hangers 1" to 4" use 13NHN-G100-600 fastener sets
- ½" and ¾" round and sleeved hangers use 13NHN-G75 fastener sets
- 2 nuts and bolts supplied to a set

Size	Description	304 Stainless Steel Part #
½" - ¾"	¼"-20 x ¾" bolt with nylock nut	<b>13NHN-G75</b>
1" - 12"	5/16"-18 x 1" bolt with nylock nut	<b>13NHN-G100-600</b>

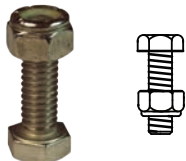

Wall Flanges - B25

Tube OD	Dimensions		Wall Thickness	304 Stainless Steel Part #
	A	B		
½"	.50"	3.00"	.065"	<b>B25-G050300</b>
½"	.50"	5.00"	.065"	<b>B25-G050500</b>
¾"	.75"	3.00"	.065"	<b>B25-G075300</b>
¾"	.75"	5.00"	.065"	<b>B25-G075500</b>
1"	1.00"	3.00"	.065"	<b>B25-G100300</b>
1"	1.00"	5.00"	.065"	<b>B25-G100500</b>
1½"	1.50"	5.00"	.065"	<b>B25-G150500</b>
2"	2.00"	5.00"	.065"	<b>B25-G200500</b>
2½"	2.50"	5.00"	.065"	<b>B25-G250500</b>
3"	3.00"	6.00"	.065"	<b>B25-G300600</b>
4"	4.00"	7.00"	.065"	<b>B25-G400700</b>
5"	5.00"	8.00"	.065"	<b>B25-G500800</b>
6"	6.00"	10.00"	.065"	<b>B25-G6001000</b>
8"	8.00"	12.00"	.065"	<b>B25-G8001200</b>
10"	10.00"	14.00"	.065"	<b>B25-G10001400</b>
12"	12.00"	16.00"	.065"	<b>B25-G12001600</b>

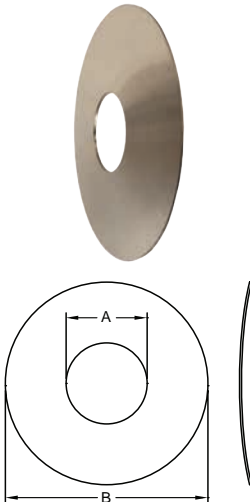

**NEW**

High Purity BioPharm Fittings

90° Weld Elbows - T2S

Size	Dimension A	PL finish - SF1 Part #	PM finish - SF4 Part #
1/2"	3.00"	T2S-050PL	T2S-050PM
3/4"	3.00"	T2S-075PL	T2S-075PM
1"	3.00"	T2S-100PL	T2S-100PM
1 1/2"	3.75"	T2S-150PL	T2S-150PM
2"	4.75"	T2S-200PL	T2S-200PM
2 1/2"	5.50"	T2S-250PL	T2S-250PM
3"	6.25"	T2S-300PL	T2S-300PM
4"	8.00"	T2S-400PL	T2S-400PM

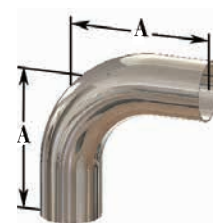

BPE Table DT-4.1.1-1

90° Clamp x Weld Elbows - T2CM

Size	Dimensions		PL finish - SF1 Part #	PM finish - SF4 Part #
	A	B		
1/2"	3.00"	1.625"	T2CM-050PL	T2CM-050PM
3/4"	3.00"	1.625"	T2CM-075PL	T2CM-075PM
1"	3.00"	2.000"	T2CM-100PL	T2CM-100PM
1 1/2"	3.75"	2.750"	T2CM-150PL	T2CM-150PM
2"	4.75"	3.500"	T2CM-200PL	T2CM-200PM
2 1/2"	5.50"	4.250"	T2CM-250PL	T2CM-250PM
3"	6.25"	5.000"	T2CM-300PL	T2CM-300PM
4"	8.00"	6.625"	T2CM-400PL	T2CM-400PM

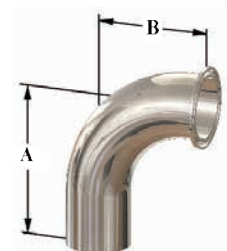

BPE Table DT-4.1.1-2

90° Clamp x Clamp Elbows - T2CMP

Size	Dimension A	PL finish - SF1 Part #	PM finish - SF4 Part #
1/2"	1.625"	T2CMP-050PL	T2CMP-050PM
3/4"	1.625"	T2CMP-075PL	T2CMP-075PM
1"	2.000"	T2CMP-100PL	T2CMP-100PM
1 1/2"	2.750"	T2CMP-150PL	T2CMP-150PM
2"	3.500"	T2CMP-200PL	T2CMP-200PM
2 1/2"	4.250"	T2CMP-250PL	T2CMP-250PM
3"	5.000"	T2CMP-300PL	T2CMP-300PM
4"	6.625"	T2CMP-400PL	T2CMP-400PM

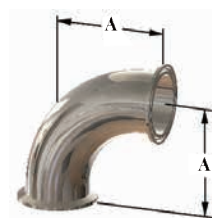

BPE Table DT-4.11.1-3

45° Weld Elbows - T2KS

Size	Dimension A	PL finish - SF1 Part #	PM finish - SF4 Part #
1/2"	2.250"	T2KS-050PL	T2KS-050PM
3/4"	2.250"	T2KS-075PL	T2KS-075PM
1"	2.250"	T2KS-100PL	T2KS-100PM
1 1/2"	2.500"	T2KS-150PL	T2KS-150PM
2"	3.000"	T2KS-200PL	T2KS-200PM
2 1/2"	3.375"	T2KS-250PL	T2KS-250PM
3"	3.625"	T2KS-300PL	T2KS-300PM
4"	4.500"	T2KS-400PL	T2KS-400PM

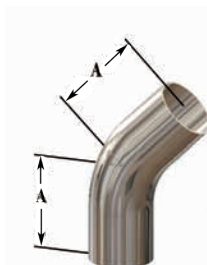

BPE Table DT-4.1.1-4

PL Finish – SF1  
 OD = 32R<sub>a</sub> Mechanically Polished  
 ID = 20R<sub>a</sub> Mechanically Polished

PM Finish – SF4  
 OD = 32R<sub>a</sub> Mechanically Polished  
 ID = 15R<sub>a</sub> Mechanically Polished and Electropolished

## High Purity BioPharm Fittings

## 45° Clamp x Weld Elbows - T2KM

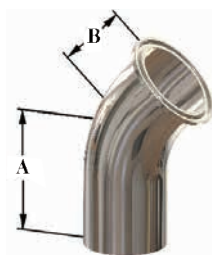

BPE Table DT-4.1.1-5

Size	Dimensions		PL finish - SF1 Part #	PM finish - SF4 Part #
	A	B		
½"	2.250"	1.000"	<b>T2KM-050PL</b>	<b>T2KM-050PM</b>
¾"	2.250"	1.000"	<b>T2KM-075PL</b>	<b>T2KM-075PM</b>
1"	2.250"	1.125"	<b>T2KM-100PL</b>	<b>T2KM-100PM</b>
1½"	2.500"	1.438"	<b>T2KM-150PL</b>	<b>T2KM-150PM</b>
2"	3.000"	1.750"	<b>T2KM-200PL</b>	<b>T2KM-200PM</b>
2½"	3.375"	2.063"	<b>T2KM-250PL</b>	<b>T2KM-250PM</b>
3"	3.625"	2.380"	<b>T2KM-300PL</b>	<b>T2KM-300PM</b>
4"	4.500"	3.125"	<b>T2KM-400PL</b>	<b>T2KM-400PM</b>

## 45° Clamp x Clamp Elbows - T2KMP



BPE Table DT-4.1.1-6

Size	Dimension A	PL finish - SF1 Part #	PM finish - SF4 Part #
½"	1.000"	<b>T2KMP-050PL</b>	<b>T2KMP-050PM</b>
¾"	1.000"	<b>T2KMP-075PL</b>	<b>T2KMP-075PM</b>
1"	1.125"	<b>T2KMP-100PL</b>	<b>T2KMP-100PM</b>
1½"	1.438"	<b>T2KMP-150PL</b>	<b>T2KMP-150PM</b>
2"	1.750"	<b>T2KMP-200PL</b>	<b>T2KMP-200PM</b>
2½"	2.063"	<b>T2KMP-250PL</b>	<b>T2KMP-250PM</b>
3"	2.380"	<b>T2KMP-300PL</b>	<b>T2KMP-300PM</b>
4"	3.125"	<b>T2KMP-400PL</b>	<b>T2KMP-400PM</b>

## Weld x Weld x Weld Tees - T7WWW

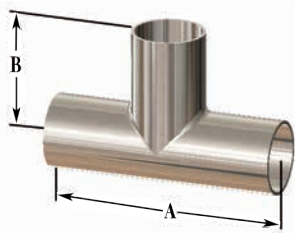

BPE Table DT-4.1.2-1

Size	Dimensions		PL finish - SF1 Part #	PM finish - SF4 Part #
	A	B		
½"	3.750"	1.875"	<b>T7WWW-050PL</b>	<b>T7WWW-050PM</b>
¾"	4.000"	2.000"	<b>T7WWW-075PL</b>	<b>T7WWW-075PM</b>
1"	4.250"	2.125"	<b>T7WWW-100PL</b>	<b>T7WWW-100PM</b>
1½"	4.750"	2.375"	<b>T7WWW-150PL</b>	<b>T7WWW-150PM</b>
2"	5.750"	2.875"	<b>T7WWW-200PL</b>	<b>T7WWW-200PM</b>
2½"	6.250"	3.125"	<b>T7WWW-250PL</b>	<b>T7WWW-250PM</b>
3"	6.750"	3.375"	<b>T7WWW-300PL</b>	<b>T7WWW-300PM</b>
4"	8.250"	4.125"	<b>T7WWW-400PL</b>	<b>T7WWW-400PM</b>

## Weld x Weld x Weld Reducing Tees - T7RWWW

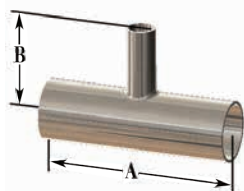

BPE Table DT-4.1.2-6

Size	Dimensions		PL finish - SF1 Part #	PM finish - SF4 Part #
	A	B		
¾" x ½"	4.000"	2.000"	<b>T7RWWW-075050PL</b>	<b>T7RWWW-075050PM</b>
1" x ½"	4.250"	2.125"	<b>T7RWWW-100050PL</b>	<b>T7RWWW-100050PM</b>
1" x ¾"	4.250"	2.125"	<b>T7RWWW-100075PL</b>	<b>T7RWWW-100075PM</b>
1½" x ½"	4.750"	2.375"	<b>T7RWWW-150050PL</b>	<b>T7RWWW-150050PM</b>
1½" x ¾"	4.750"	2.375"	<b>T7RWWW-150075PL</b>	<b>T7RWWW-150075PM</b>
1½" x 1"	4.750"	2.375"	<b>T7RWWW-150100PL</b>	<b>T7RWWW-150100PM</b>
2" x ½"	5.750"	2.625"	<b>T7RWWW-200050PL</b>	<b>T7RWWW-200050PM</b>
2" x ¾"	5.750"	2.625"	<b>T7RWWW-200075PL</b>	<b>T7RWWW-200075PM</b>
2" x 1"	5.750"	2.625"	<b>T7RWWW-200100PL</b>	<b>T7RWWW-200100PM</b>
2" x 1½"	5.750"	2.625"	<b>T7RWWW-200150PL</b>	<b>T7RWWW-200150PM</b>

PL Finish – SF1

OD = 32R<sub>a</sub> Mechanically PolishedID = 20R<sub>a</sub> Mechanically Polished

PM Finish – SF4

OD = 32R<sub>a</sub> Mechanically PolishedID = 15R<sub>a</sub> Mechanically Polished and Electropolished

## High Purity BioPharm Fittings

## Weld x Weld x Clamp Short Outlet Tees - T7WWMS

Size	Dimensions		PL finish - SF1 Part #	PM finish - SF4 Part #
	A	B		
½"	3.750"	1.000"	<i>T7WWMS-050PL</i>	<i>T7WWMS-050PM</i>
¾"	4.000"	1.125"	<i>T7WWMS-075PL</i>	<i>T7WWMS-075PM</i>
1"	4.250"	1.125"	<i>T7WWMS-100PL</i>	<i>T7WWMS-100PM</i>
1½"	4.750"	1.375"	<i>T7WWMS-150PL</i>	<i>T7WWMS-150PM</i>
2"	5.750"	1.625"	<i>T7WWMS-200PL</i>	<i>T7WWMS-200PM</i>
2½"	6.250"	1.825"	<i>T7WWMS-250PL</i>	<i>T7WWMS-250PM</i>
3"	6.750"	2.125"	<i>T7WWMS-300PL</i>	<i>T7WWMS-300PM</i>
4"	8.250"	2.750"	<i>T7WWMS-400PL</i>	<i>T7WWMS-400PM</i>

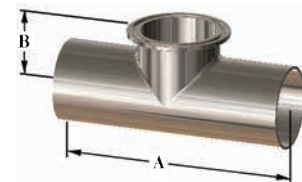

BPE Table DT-4.1.2-2

Sanitary  
Fittings

## Weld x Weld x Clamp Tees - T7WWM

Size	Dimensions		PL finish - SF1 Part #	PM finish - SF4 Part #
	A	B		
½"	3.750"	2.250"	<i>T7WWM-050PL</i>	<i>T7WWM-050PM</i>
¾"	4.000"	2.375"	<i>T7WWM-075PL</i>	<i>T7WWM-075PM</i>
1"	4.250"	2.625"	<i>T7WWM-100PL</i>	<i>T7WWM-100PM</i>
1½"	4.750"	2.875"	<i>T7WWM-150PL</i>	<i>T7WWM-150PM</i>
2"	5.750"	3.375"	<i>T7WWM-200PL</i>	<i>T7WWM-200PM</i>
2½"	6.250"	3.625"	<i>T7WWM-250PL</i>	<i>T7WWM-250PM</i>
3"	6.750"	3.875"	<i>T7WWM-300PL</i>	<i>T7WWM-300PM</i>
4"	8.250"	4.750"	<i>T7WWM-400PL</i>	<i>T7WWM-400PM</i>

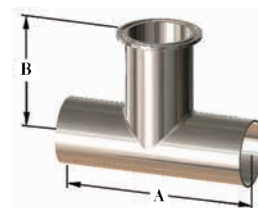

## Clamp x Clamp x Clamp Tees - T7MP

Size	Dimensions		PL finish - SF1 Part #	PM finish - SF4 Part #
	A	B		
½"	4.500"	2.250"	<i>T7MP-050PL</i>	<i>T7MP-050PM</i>
¾"	4.750"	2.375"	<i>T7MP-075PL</i>	<i>T7MP-075PM</i>
1"	5.250"	2.625"	<i>T7MP-100PL</i>	<i>T7MP-100PM</i>
1½"	5.750"	2.875"	<i>T7MP-150PL</i>	<i>T7MP-150PM</i>
2"	6.750"	3.375"	<i>T7MP-200PL</i>	<i>T7MP-200PM</i>
2½"	7.250"	3.625"	<i>T7MP-250PL</i>	<i>T7MP-250PM</i>
3"	7.750"	3.875"	<i>T7MP-300PL</i>	<i>T7MP-300PM</i>
4"	9.500"	4.750"	<i>T7MP-400PL</i>	<i>T7MP-400PM</i>

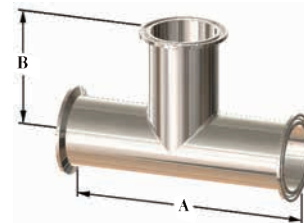

BPE Table DT-4.1.2-4

PL Finish – SF1  
 OD = 32R<sub>a</sub> Mechanically Polished  
 ID = 20R<sub>a</sub> Mechanically Polished

PM Finish – SF4  
 OD = 32R<sub>a</sub> Mechanically Polished  
 ID = 15R<sub>a</sub> Mechanically Polished and Electropolished

High Purity BioPharm Fittings

Weld x Weld Concentric Reducers - T31W

Sanitary  
Fittings

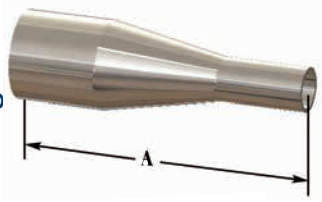

BPE Table DT-4.1.3-1(a)

Size	Dimension A	PL finish - SF1 Part #	PM finish - SF4 Part #
¾" x ½"	4.00"	<b>2211CBB075050F1</b>	<b>2211CBB075050F4</b>
1" x ½"	4.50"	<b>2211CBB100050F1</b>	<b>2211CBB100050F4</b>
1" x ¾"	4.00"	<b>2211CBB100075F1</b>	<b>2211CBB100075F4</b>
1½" x ¾"	5.00"	<b>2211CBB150075F1</b>	<b>2211CBB150075F4</b>
1½" x 1"	5.00"	<b>2211CBB150100F1</b>	<b>2211CBB150100F4</b>
2" x 1"	7.25"	<b>2211CBB200100F1</b>	<b>2211CBB200100F4</b>
2" x 1½"	5.25"	<b>2211CBB200150F1</b>	<b>2211CBB200150F4</b>

Clamp x Clamp Concentric Reducers - T3114MP

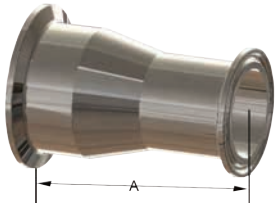

BPE Table DT-4.1.3-3(a)

Size	Dimension A	PL finish - SF1 Part #	PM finish - SF4 Part #
¾" x ½"	2.000"	<b>2221CBB075050F1</b>	<b>2221CBB075050F4</b>
1" x ½"	2.500"	<b>2221CBB100050F1</b>	<b>2221CBB100050F4</b>
1" x ¾"	2.000"	<b>2221CBB100075F1</b>	<b>2221CBB100075F4</b>
1½" x ¾"	3.000"	<b>2221CBB150075F1</b>	<b>2221CBB150075F4</b>
1½" x 1"	3.000"	<b>2221CBB150100F1</b>	<b>2221CBB150100F4</b>
2" x 1"	5.000"	<b>2221CBB200100F1</b>	<b>2221CBB200100F4</b>
2" x 1½"	3.000"	<b>2221CBB200150F1</b>	<b>2221CBB200150F4</b>

PL Finish – SF1  
OD = 32R<sub>a</sub> Mechanically Polished  
ID = 20R<sub>a</sub> Mechanically Polished

PM Finish – SF4  
OD = 32R<sub>a</sub> Mechanically Polished  
ID = 15R<sub>a</sub> Mechanically Polished and Electropolished

## High Purity BioPharm Fittings

## Weld x Weld Eccentric Reducers - T32W

Size	Dimension A	PL finish - SF1 Part #	PM finish - SF4 Part #
3/4" x 1/2"	4.00"	<b>2211EBB075050F1</b>	<b>2211EBB075050F4</b>
1" x 1/2"	4.50"	<b>2211EBB100050F1</b>	<b>2211EBB100050F4</b>
1" x 3/4"	4.00"	<b>2211EBB100075F1</b>	<b>2211EBB100075F4</b>
1 1/2" x 3/4"	5.00"	<b>2211EBB150075F1</b>	<b>2211EBB150075F4</b>
1 1/2" x 1"	5.00"	<b>2211EBB150100F1</b>	<b>2211EBB150100F4</b>
2" x 1"	7.25"	<b>2211EBB200100F1</b>	<b>2211EBB200100F4</b>
2" x 1 1/2"	5.25"	<b>2211EBB200150F1</b>	<b>2211EBB200150F4</b>

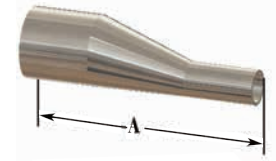

BPE Table DT-4.1.3-1(a)

Sanitary  
Fittings

## Clamp x Clamp Eccentric Reducers - T3214MP

Size	Dimension A	PL finish - SF1 Part #	PM finish - SF4 Part #
3/4" x 1/2"	2.000"	<b>2221EBB075050F1</b>	<b>2221EBB075050F4</b>
1" x 1/2"	2.500"	<b>2221EBB100050F1</b>	<b>2221EBB100050F4</b>
1" x 3/4"	2.000"	<b>2221EBB100075F1</b>	<b>2221EBB100075F4</b>
1 1/2" x 3/4"	3.000"	<b>2221EBB150075F1</b>	<b>2221EBB150075F4</b>
1 1/2" x 1"	3.000"	<b>2221EBB150100F1</b>	<b>2221EBB150100F4</b>
2" x 1"	5.000"	<b>2221EBB200100F1</b>	<b>2221EBB200100F4</b>
2" x 1 1/2"	3.000"	<b>2221EBB200150F1</b>	<b>2221EBB200150F4</b>

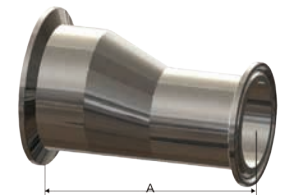

BPE Table DT-4.1.3-3(a)

PL Finish – SF1  
 OD = 32R<sub>a</sub> Mechanically Polished  
 ID = 20R<sub>a</sub> Mechanically Polished

PM Finish – SF4  
 OD = 32R<sub>a</sub> Mechanically Polished  
 ID = 15R<sub>a</sub> Mechanically Polished and Electropolished

## High Purity BioPharm Fittings

## Solid End Caps - T16AMP

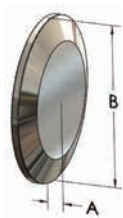
Sanitary  
Fittings

BPE Table DT-4.1.5-2

Size	Dimensions		PL finish - SF1 Part #	PM finish - SF4 Part #
	A	B		
½" - ¾"	0.19"	0.98"	<b>T16AMP-050075PL</b>	<b>T16AMP-050075PM</b>
1" - 1½"	0.25"	1.98"	<b>T16AMP-100150PL</b>	<b>T16AMP-100150PM</b>
2"	0.25"	2.52"	<b>T16AMP-200PL</b>	<b>T16AMP-200PM</b>
2½"	0.25"	3.05"	<b>T16AMP-250PL</b>	<b>T16AMP-250PM</b>
3"	0.25"	3.58"	<b>T16AMP-300PL</b>	<b>T16AMP-300PM</b>
4"	0.31"	4.68"	<b>T16AMP-400PL</b>	<b>T16AMP-400PM</b>

## Auto Weld Ferrules - TL14AM7

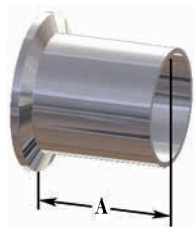

BPE Table DT-4.1.4-1

Size	Dimension A	PL finish - SF1 Part #	PM finish - SF4 Part #
½"	1.75"	<b>TL14AM7-050PL</b>	<b>TL14AM7-050PM</b>
¾"	1.75"	<b>TL14AM7-075PL</b>	<b>TL14AM7-075PM</b>
1"	1.75"	<b>TL14AM7-100PL</b>	<b>TL14AM7-100PM</b>
1½"	1.75"	<b>TL14AM7-150PL</b>	<b>TL14AM7-150PM</b>
2"	2.25"	<b>TL14AM7-200PL</b>	<b>TL14AM7-200PM</b>
2½"	2.25"	<b>TL14AM7-250PL</b>	<b>TL14AM7-250PM</b>
3"	2.25"	<b>TL14AM7-300PL</b>	<b>TL14AM7-300PM</b>
4"	2.25"	<b>TL14AM7-400PL</b>	<b>TL14AM7-400PM</b>

## Weld Caps - T16W

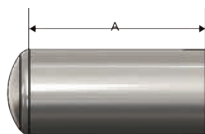

BPE Table DT-4.1.5-1

Size	Dimension A	PL finish - SF1 Part #	PM finish - SF4 Part #
½"	1.50"	<b>T16W-050PL</b>	<b>T16W-050PM</b>
¾"	1.50"	<b>T16W-075PL</b>	<b>T16W-075PM</b>
1"	1.50"	<b>T16W-100PL</b>	<b>T16W-100PM</b>
1½"	1.50"	<b>T16W-150PL</b>	<b>T16W-150PM</b>
2"	1.50"	<b>T16W-200PL</b>	<b>T16W-200PM</b>

PL Finish – SF1  
 OD = 32R<sub>a</sub> Mechanically Polished  
 ID = 20R<sub>a</sub> Mechanically Polished

PM Finish – SF4  
 OD = 32R<sub>a</sub> Mechanically Polished  
 ID = 15R<sub>a</sub> Mechanically Polished and Electropolished



## 2-Way 3 Piece Encapsulated Ball Valves

**Materials:**

- body, ends and ball: CF8M stainless
- seats: virgin PTFE, 15% glass reinforced RTFE, 25% carbon reinforced PTFE, 50% stainless steel reinforced PTFE or UHMW

**Features:**

- live-loaded stem packing
- precision stainless steel balls reduce torque and friction losses while extending seat life
- integral ISO 5211 mounting pad
- ID polish is  $R_a$  32 minimum
- lockable handle can prevent accidental actuation
- standard internal entry blow out proof stem design
- full port design matches ball and seat ports to tube ID for lower pressure drop and less turbulent flow
- compact design for areas with tight space restrictions
- fully encapsulated construction produces bubble tight seal
- identification tagging available
- balanced encapsulated construction minimizes cold flow

**Specifications:**

- maximum pressure rating: ½" - 2" **1000 PSI WOG**, 2½" - 4" **800 PSI WOG**
- for valves seat options, call Dixon
- repair kits available

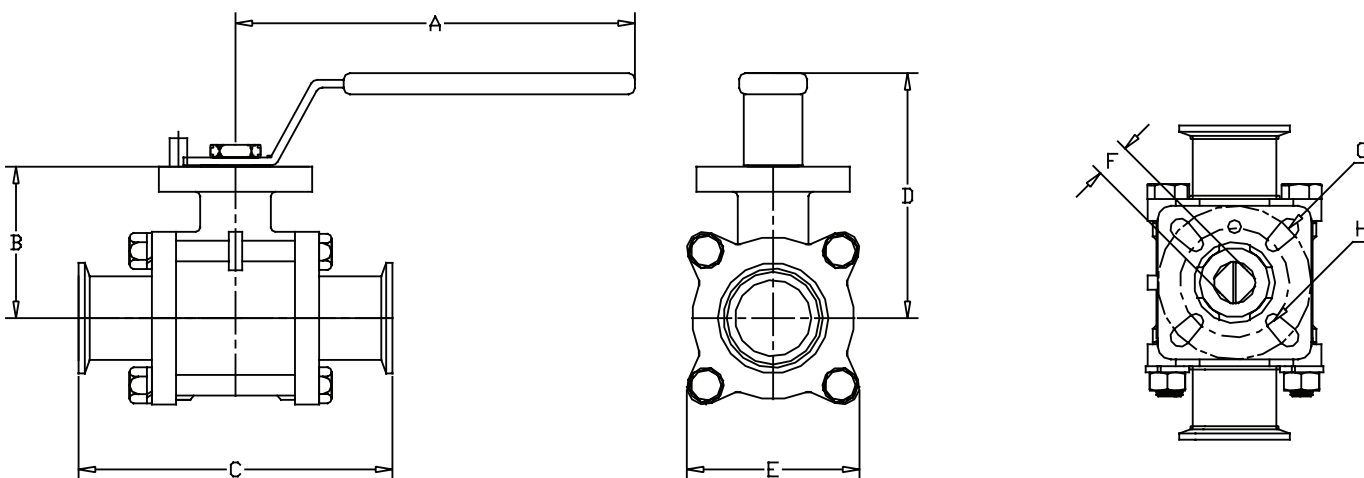
Sanitary  
Fittings

Size	Dimensions								316 Stainless Steel Part #
	A	B	C	D	E	F (mm)	G (mm)	H (mm)	
½"	4.9"	1.5"	4.3"	3.1"	2.0"	9	42	36	<b>BV2CV-050CC-A</b>
¾"	4.9"	1.8"	4.7"	3.4"	2.2"	9	42	36	<b>BV2CV-075CC-A</b>
1"	5.4"	2.1"	4.9"	3.6"	2.4"	11	50	42	<b>BV2CV-100CC-A</b>
1½"	9.3"	2.7"	5.6"	4.4"	3.2"	14	70	50	<b>BV2CV-150CC-A</b>
2"	9.3"	3.1"	6.4"	4.7"	3.8"	14	70	50	<b>BV2CV-200CC-A</b>
2½"	18.0"	3.8"	7.8"	5.2"	4.9"	17	102	70	<b>BV2CV-250CC-A</b>
3"	18.3"	4.2"	9.0"	5.7"	5.4"	17	102	70	<b>BV2CV-300CC-A</b>
4"	18.3"	5.3"	9.6"	6.9"	8.7"	22	125	102	<b>BV2CV-400CC-A</b>

Our commitment to excellence and continuous research and development for improving product quality may warrant periodic changes in design and specification. We reserve the right to modify product design without prior notification and without incurring any liability to provide these modifications to products previously purchased.

Non-Encapsulated 2-way 3 Piece Stainless Steel Ball Valves

Sanitary Fittings



**Materials:**

- body, ends and ball: CF8M stainless
- seats: 15% glass reinforced PTFE

**Features:**

- blow-out proof stem
- live-loaded stem packing
- ID polish is  $R_a 32$
- lockable handle

**Specifications:**

- maximum pressure rating: ½" - 2" **1000 PSI WOG**, 2½" - 4" **800 PSI WOG**
- maximum temperature: **300°F (149°C)**
- repair kits available

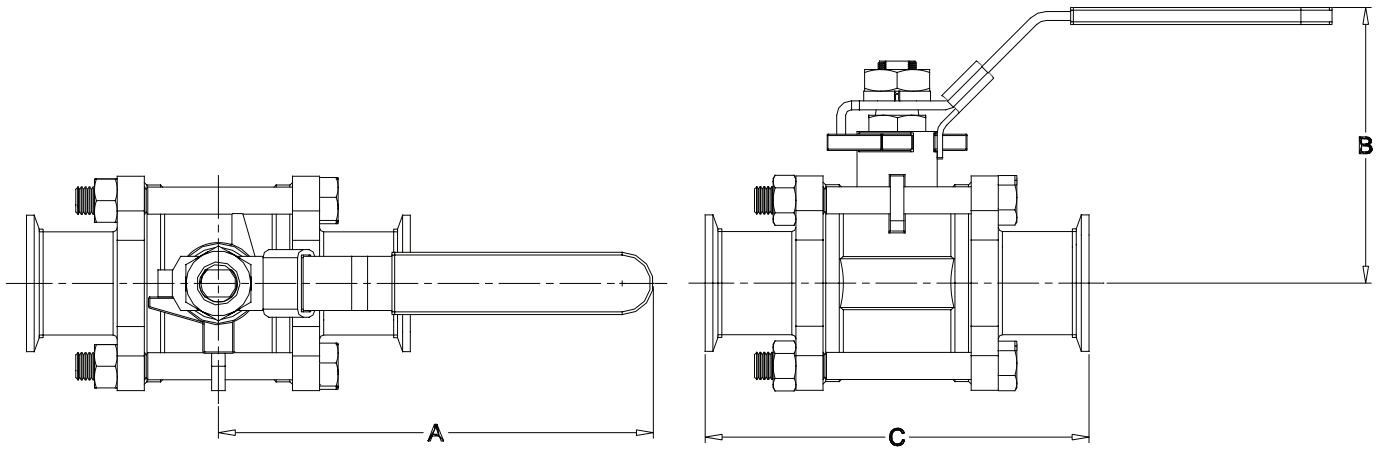

Size	Dimensions			316 Stainless Steel Part #
	A	B	C	
½"	4.1"	2.3"	4.6"	<b>BV2GG-050CC-A</b>
¾"	4.1"	2.5"	4.7"	<b>BV2GG-075CC-A</b>
1"	5.0"	2.8"	4.9"	<b>BV2GG-100CC-A</b>
1½"	6.1"	3.5"	5.6"	<b>BV2GG-150CC-A</b>
2"	7.6"	3.9"	6.4"	<b>BV2GG-200CC-A</b>
2½"	7.6"	4.4"	7.8"	<b>BV2GG-250CC-A</b>
3"	10.9"	4.9"	9.0"	<b>BV2GG-300CC-A</b>
4"	13.2"	6.6"	9.6"	<b>BV2GG-400CC-A</b>

Dimensions are approximate. Engineering dimensions are available upon request. Specifications are subject to change without notice.

## Butterfly Valves

## Materials:

- body and disc: 316L
- seat: EPDM, FKM, (6" EPDM and silicone, 8" EPDM only)

## Features:

- low resistance to flow
- bi-directions flow
- gentle to media
- suitable for low and medium viscosity fluids
- can be serviced in the field
- self-draining
- various manual or automatic operators available, call Dixon Sanitary for details 800.789.1718
- optional wing nut kit is available for easy assembly and disassembly
- 100% hydraulic tested / 100% inspected

## Specifications:

- vacuum rating: 0.4 inches Hg at 68°F (20°C)
- operating temperature range: 15°F to 200°F (-9°C to 93°C)

## Clamp End with Pull Handle - [A]

Size	316L Stainless Steel with Silicone Seats Part #	316L Stainless Steel with FKM Seats Part #	316L Stainless Steel with EPDM Seats Part #
1/2"	<b>B5101S050CC-A</b>	<b>B5101V050CC-A</b>	<b>B5101E050CC-A</b>
3/4"	<b>B5101S075CC-A</b>	<b>B5101V075CC-A</b>	<b>B5101E075CC-A</b>
1"	<b>B5101S100CC-A</b>	<b>B5101V100CC-A</b>	<b>B5101E100CC-A</b>
1 1/2"	<b>B5101S150CC-A</b>	<b>B5101V150CC-A</b>	<b>B5101E150CC-A</b>
2"	<b>B5101S200CC-A</b>	<b>B5101V200CC-A</b>	<b>B5101E200CC-A</b>
2 1/2"	<b>B5101S250CC-A</b>	<b>B5101V250CC-A</b>	<b>B5101E250CC-A</b>
3"	<b>B5101S300CC-A</b>	<b>B5101V300CC-A</b>	<b>B5101E300CC-A</b>
4" <sup>1</sup>	<b>B5101S400CC-A</b>	<b>B5101V400CC-A</b>	<b>B5101E400CC-A</b>
6"	<b>B5101S600CC-A</b>	---	<b>B5101E600CC-A</b>
8"	---	---	<b>B5101E800CC-A</b>

<sup>1</sup> 4" high pressure butterfly valve is available, call Dixon® for more information



Size	Dimensions						
	A	B	C	D	E	F	G
1/2"	4.4"	2.8"	1.4"	0.9"	3.5"	.37"	3.1"
3/4"	4.4"	2.8"	1.4"	0.9"	3.5"	.62"	3.1"
1"	4.4"	2.8"	1.4"	0.9"	3.5"	0.9"	3.1"
1 1/2"	4.4"	2.8"	1.4"	0.9"	3.5"	1.4"	3.1"
2"	4.4"	3.1"	1.4"	0.9"	3.8"	1.9"	3.9"
2 1/2"	4.4"	3.5"	1.4"	0.9"	3.8"	2.4"	4.6"
3"	6.2"	3.8"	1.3"	1.2"	4.1"	2.9"	5.2"
4"	6.2"	4.5"	1.3"	1.2"	4.8"	3.8"	6.7"
6"	11.5"	5.5"	1.3"	1.2"	5.5"	5.8"	8.5"
8"	18.0"	6.9"	1.6"	1.2"	4.9"	7.8"	11.2"

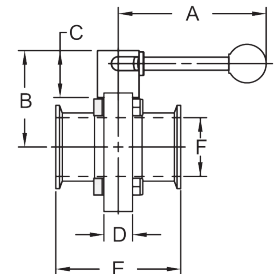
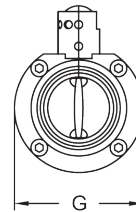

## Clamp End with Infinite Position Handle - [B]

Size	316L Stainless Steel with Silicone Seats Part #	316L Stainless Steel with FKM Seats Part #	316L Stainless Steel with EPDM Seats Part #
1/2"	<b>B5101S050CC-B</b>	<b>B5101V050CC-B</b>	<b>B5101E050CC-B</b>
3/4"	<b>B5101S075CC-B</b>	<b>B5101V075CC-B</b>	<b>B5101E075CC-B</b>
1"	<b>B5101S100CC-B</b>	<b>B5101V100CC-B</b>	<b>B5101E100CC-B</b>
1 1/2"	<b>B5101S150CC-B</b>	<b>B5101V150CC-B</b>	<b>B5101E150CC-B</b>
2"	<b>B5101S200CC-B</b>	<b>B5101V200CC-B</b>	<b>B5101E200CC-B</b>
2 1/2"	<b>B5101S250CC-B</b>	<b>B5101V250CC-B</b>	<b>B5101E250CC-B</b>
3"	<b>B5101S300CC-B</b>	<b>B5101V300CC-B</b>	<b>B5101E300CC-B</b>
4"	<b>B5101S400CC-B</b>	<b>B5101V400CC-B</b>	<b>B5101E400CC-B</b>

Size	Dimensions						
	A	B	C	D	E	F	G
1/2"	4.3"	2.6"	1.3"	0.9"	3.5"	.37"	3.1"
3/4"	4.3"	2.6"	1.3"	0.9"	3.5"	.62"	3.1"
1"	4.3"	2.6"	1.3"	0.9"	3.5"	.90"	3.1"
1 1/2"	4.3"	2.6"	1.3"	0.9"	3.5"	1.40"	3.1"
2"	4.3"	2.9"	1.3"	0.9"	3.8"	1.90"	3.9"
2 1/2"	4.3"	3.3"	1.3"	0.9"	3.8"	2.40"	4.6"
3"	6.4"	3.6"	1.3"	1.2"	4.1"	2.90"	5.2"
4"	6.4"	4.4"	1.3"	1.2"	4.8"	3.80"	6.7"

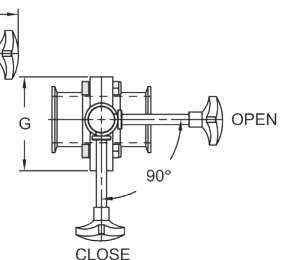
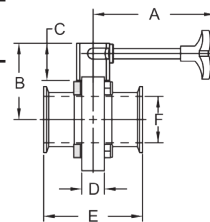

**Butterfly Valves**

Clamp End with Trigger Handle - [C]

Sanitary Fittings

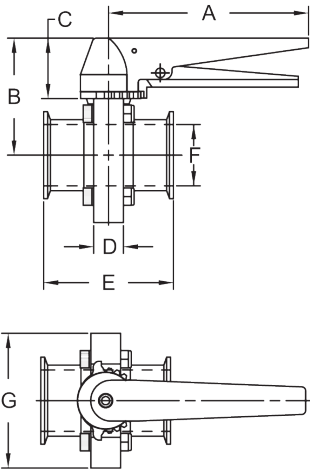

Size	316L Stainless Steel with Silicone Seats Part #	316L Stainless Steel with FKM Seats Part #	316L Stainless Steel with EPDM Seats Part #
1/2"	<b>B5101S050CC-C</b>	<b>B5101V050CC-C</b>	<b>B5101E050CC-C</b>
3/4"	<b>B5101S075CC-C</b>	<b>B5101V075CC-C</b>	<b>B5101E075CC-C</b>
1"	<b>B5101S100CC-C</b>	<b>B5101V100CC-C</b>	<b>B5101E100CC-C</b>
1 1/2"	<b>B5101S150CC-C</b>	<b>B5101V150CC-C</b>	<b>B5101E150CC-C</b>
2"	<b>B5101S200CC-C</b>	<b>B5101V200CC-C</b>	<b>B5101E200CC-C</b>
2 1/2"	<b>B5101S250CC-C</b>	<b>B5101V250CC-C</b>	<b>B5101E250CC-C</b>
3"	<b>B5101S300CC-C</b>	<b>B5101V300CC-C</b>	<b>B5101E300CC-C</b>
4"	<b>B5101S400CC-C</b>	<b>B5101V400CC-C</b>	<b>B5101E400CC-C</b>

Size	Dimensions						
	A	B	C	D	E	F	G
1/2"	6.6"	3.0"	1.7"	0.9"	3.5"	.37"	3.1"
3/4"	6.6"	3.0"	1.7"	0.9"	3.5"	.62"	3.1"
1"	6.6"	3.0"	1.7"	0.9"	3.5"	.90"	3.1"
1 1/2"	6.6"	3.0"	1.7"	0.9"	3.5"	1.40"	3.1"
2"	6.6"	3.5"	1.7"	0.9"	3.8"	1.90"	3.9"
2 1/2"	6.6"	3.7"	1.7"	0.9"	3.8"	2.40"	4.6"
3"	6.6"	3.9"	1.7"	1.2"	4.1"	2.90"	5.2"
4"	6.6"	4.8"	1.7"	1.2"	4.8"	3.80"	6.7"

**Repair Kits for Butterfly Valves**

**Features:**

Repair kit contains:

- (1) seat
- (2) bushings

for valves located on pages 633 and 634



Valve Size	Black EPDM Part #	Red Silicone Part #	Brown FKM Part #
1/2" - 1"	<b>B5101-RKE100</b>	<b>B5101-RKS100</b>	<b>B5101-RKV100</b>
1 1/2"	<b>B5101-RKE150</b>	<b>B5101-RKS150</b>	<b>B5101-RKV150</b>
2"	<b>B5101-RKE200</b>	<b>B5101-RKS200</b>	<b>B5101-RKV200</b>
2 1/2"	<b>B5101-RKE250</b>	<b>B5101-RKS250</b>	<b>B5101-RKV250</b>
3"	<b>B5101-RKE300</b>	<b>B5101-RKS300</b>	<b>B5101-RKV300</b>
4"	<b>B5101-RKE400</b>	<b>B5101-RKS400</b>	<b>B5101-RKV400</b>
6"	<b>B5101-RKE600</b>	<b>B5101-RKS600</b>	---
8"	<b>B5107-RKE800</b>	---	---

Our commitment to excellence and continuous research and development for improving product quality may warrant periodic changes in design and specification. We reserve the right to modify product design without prior notification and without incurring any liability to provide these modifications to products previously purchased.

**Butterfly Valves****Clamp****Materials:**

- contact product surfaces: sanitary finish 316L stainless steel
- seat: silicone, EPDM, FKM

**Features:**

- all sizes use only ¾" of line space
- the grooved clamp housing connects directly to the corresponding sanitary clamp size
- PTFE valve disc bushings reduce friction and increase cycle life
- 3-position reversible handle
- 100% tested / 100% inspected
- can be serviced in field (no special tools required)
- can be modified for lockout / tagout
- various automated options available

**Specifications:**

- vacuum rating: 0.4 inches Hg @ 68°F (20°C)
- operating temperature range: 15°F to 200°F (-9°C to 93°C)

Information supplied based on water media @ 68°F (20°C)

Size	Break Torque (in-lbs.)	Assembly Torque (in-lbs.)	Pressure Rating (PSI)	Flow Coefficient (C <sub>v</sub> )	Weight w/standard handle (lbs.)
1"	125	36	<b>140</b>	23	1.5
1½"	185	36	<b>140</b>	80	2
2"	200	21.6	<b>120</b>	230	2.5
2½"	260	21.6	<b>120</b>	264	3
3"	350	28.8	<b>100</b>	372	4
4"	495	43.2	<b>70</b>	800	6

Size	316L Stainless Steel with Silicone Seats Part #	316L Stainless Steel with FKM Seats Part #	316L Stainless Steel with EPDM Seats Part #
1"	<b>B5102S100-A</b>	<b>B5102V100-A</b>	<b>B5102E100-A</b>
1½"	<b>B5102S150-A</b>	<b>B5102V150-A</b>	<b>B5102E150-A</b>
2"	<b>B5102S200-A</b>	<b>B5102V200-A</b>	<b>B5102E200-A</b>
2½"	<b>B5102S250-A</b>	<b>B5102V250-A</b>	<b>B5102E250-A</b>
3"	<b>B5102S300-A</b>	<b>B5102V300-A</b>	<b>B5102E300-A</b>
4"	<b>B5102S400-A</b>	<b>B5102V400-A</b>	<b>B5102E400-A</b>

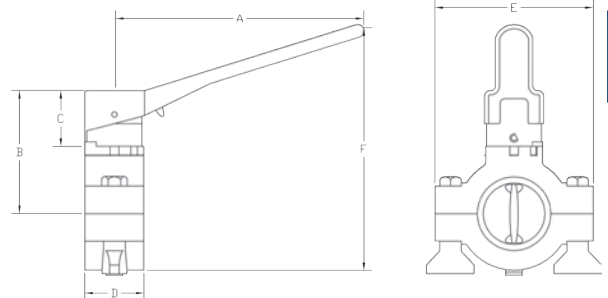

Size	Dimensions						PSI @ 68°F (20°C)
	A	B	C	D	E	F	
1"	5.6"	2.8"	1.3"	1.3"	3.6"	5.6"	<b>140</b>
1½"	5.6"	2.8"	1.3"	1.3"	3.6"	5.6"	<b>140</b>
2"	5.6"	3.0"	1.3"	1.3"	4.1"	6.1"	<b>120</b>
2½"	5.6"	3.3"	1.3"	1.3"	4.6"	6.6"	<b>120</b>
3"	5.6"	3.6"	1.3"	1.3"	5.3"	7.1"	<b>100</b>
4"	5.6"	4.1"	1.3"	1.3"	6.4"	8.2"	<b>70</b>

**Repair Kits for Clamp Butterfly Valves**

Repair kit contains:

- (1) seat
- (2) bushings

Valve Size	Black EPDM Part #	Red Silicone Part #	Brown FKM Part #
1"	<b>B5102-RKE100</b>	<b>B5102-RKS100</b>	<b>B5102-RKV100</b>
1½"	<b>B5102-RKE150</b>	<b>B5102-RKS150</b>	<b>B5102-RKV150</b>
2"	<b>B5102-RKE200</b>	<b>B5102-RKS200</b>	<b>B5102-RKV200</b>
2½"	<b>B5102-RKE250</b>	<b>B5102-RKS250</b>	<b>B5102-RKV250</b>
3"	<b>B5102-RKE300</b>	<b>B5102-RKS300</b>	<b>B5102-RKV300</b>
4"	<b>B5102-RKE400</b>	<b>B5102-RKS400</b>	<b>B5102-RKV400</b>



B5102-RKS100

**NEW**

**B5115 Series - 304 Stainless Steel Butterfly Valves**

**Features:**

- 100% tested / 100% inspected
- product contact are sanitary finish to <math>32R\_a</math>
- can be serviced in field
- silicone seats
- blue trigger handle
- operating temperature range: 15°F to 200°F (-9°C to 93°C)
- maximum operating pressure: 110 PSI

Sanitary  
Fittings



**Clamp End with Trigger Handle**

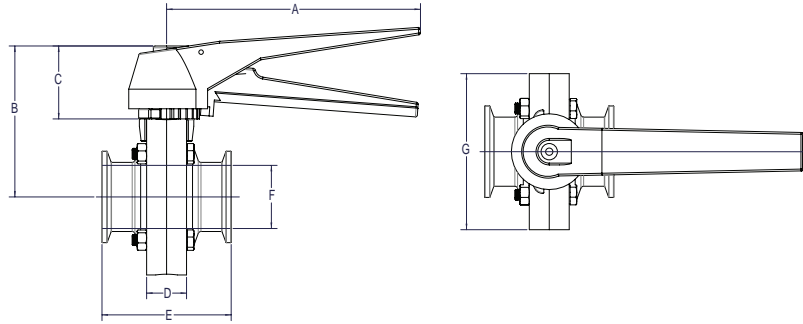

Size	Dimensions							304 Stainless Steel Part #
	A	B	C	D	E	F	G	
1½"	5.70"	3.40"	1.60"	0.87"	2.80"	1.40"	3.40"	<b>B5115S150CC-C</b>
2"	5.70"	3.60"	1.60"	0.87"	3.00"	1.90"	3.90"	<b>B5115S200CC-C</b>
3"	5.70"	4.20"	1.60"	0.87"	3.30"	2.90"	5.00"	<b>B5115S300CC-C</b>
4"	6.89"	5.51"	1.60"	0.87"	3.62"	3.83"	6.89"	<b>B5115S400CC-C</b>

**Weld End with Trigger Handle**

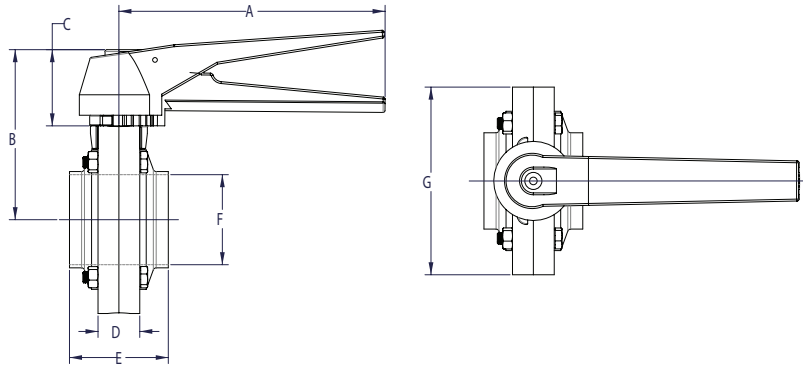

Size	Dimensions							304 Stainless Steel Part #
	A	B	C	D	E	F	G	
1½"	5.70"	3.40"	1.60"	0.87"	1.97"	1.40"	3.40"	<b>B5115S150BB-C</b>
2"	5.70"	3.60"	1.60"	0.87"	2.05"	1.90"	3.90"	<b>B5115S200BB-C</b>
3"	5.70"	4.20"	1.60"	0.87"	2.12"	2.90"	5.00"	<b>B5115S300BB-C</b>
4"	6.89"	5.51"	1.60"	0.87"	2.52"	3.83"	6.89"	<b>B5115S400BB-C</b>

**Replacement Seats**

Size	Part #
1½"	<b>B5115-RKS150</b>
2"	<b>B5115-RKS200</b>
3"	<b>B5115-RKS300</b>
4"	<b>B5115-RKS400</b>

Note: Cannot be actuated and is supplied with silicone seats only.

## HSC Series Spring Check Valve

Sanitary  
Fittings**Features:**

- single piece upper body spider design
- machined from solid bar
- standard O-ring and gasket seal design
- can be serviced in field (no special tools required)
- finish: sanitary polish 32 R<sub>a</sub>
- suitable for low and medium viscosity fluids
- connection: clamp (standard), others available upon request

Size	Pressure Rating	Cracking Pressure (PSI)	Operating Temperature	316L stainless steel Part #
1/2"	145 PSI	10.0	15°F to 200°F (-9°C to 93°C)	HSC*050
3/4"		4.0		HSC*075
1"		2.5		HSC*100
1 1/2"		1.0		HSC*150
2"		1.5		HSC*200
2 1/2"		0.8		HSC*250
3"		0.5		HSC*300
4"		0.4		HSC*400



\*V=FKM or E=EPDM

**Repair Kits**

Size	Part #
1/2"	HSC-RK*050
3/4"	HSC-RK*075
1"	HSC-RK*100
1 1/2"	HSC-RK*150
2"	HSC-RK*200
2 1/2"	HSC-RK*250
3"	HSC-RK*300
4"	HSC-RK*400

1/2"-3/4" repair kit contains:  
 (1) body gasket  
 (1) plunger O-ring  
 (1) spider O-ring

1"-4" repair kit contains:  
 (1) body gasket  
 (1) plunger O-ring

\*V=FKM or E=EPDM

**Dimensions**

Size	A
1/2"	2.7"
3/4"	2.7"
1"	3.3"
1 1/2"	3.4"
2"	3.4"
2 1/2"	3.4"
3"	3.4"
4"	4.1"



## B45BY Series Y - Ball Check Valve

  
1447
**Applications:**

- When liquid flows through the valve, the ball is forced into the branch of the valve allowing full fluid flow. When the liquid stops, equalizing the pressure, the ball drops back into the seat, preventing backflow. Should reverse flow occur, the differential pressure will cause the ball to seal firmly against the seat preventing leakage.

**Materials:**

- ball: PTFE
- product contact surfaces: 316L stainless steel

**Features:**

- two-piece construction
- replaceable seat
- can be serviced in field (no special tools required)

**Specifications:**

- operating temperature range: 15°F to 200°F (-9°C to 93°C)
- maximum operating pressure: 150 PSI

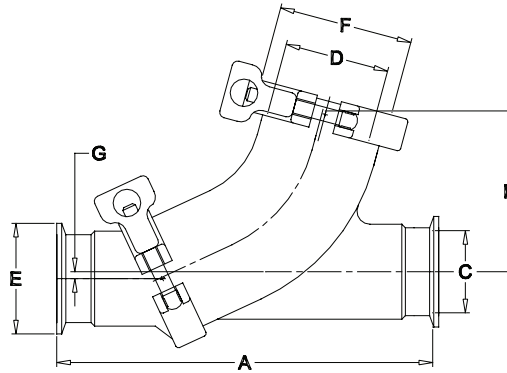
**Dimensions**

Valve Size	Clamp & Cap Size	A	B	C	D	E	F	G	Ball Diameter	Weight (lbs)	316L Stainless Steel Part #
1½"	2"	7.50"	3.30"	1.36"	1.87"	1.98"	2.51"	0.16"	1.6"	4.9	<b>B45BY-R150</b>
2"	2½"	8.50"	3.90"	1.86"	2.33"	2.51"	3.04"	0.16"	2.1"	6.6	<b>B45BY-R200</b>
2½"	3"	10.00"	4.50"	2.37"	2.87"	3.04"	3.57"	0.16"	2.7"	10.5	<b>B45BY-R250</b>
3"	4"	11.50"	5.30"	2.87"	3.83"	3.57"	4.68"	0.16"	3.6"	17.5	<b>B45BY-R300</b>

All dimensions are approximate. Engineering dimensions are available upon request.  
Specifications are subject to change without notice.

**Repair and Seal Kits****Repair kit contains:**

- (1) EPDM cap gasket
- (1) PTFE ball
- (1) EPDM/CF8M seat

**Seal kit contains:**

- (1) EPDM cap gasket
- (1) EPDM/CF8M seat

**FKM seal kit contains:**

- (1) FKM cap gasket
- (1) FKM /CF8M seat

Size	Repair Kit Part #	Seal Kit Part #	FKM Seal Kit Part #	Replacement Ball Only Part #
1½"	<b>B45BY-RK150</b>	<b>B45BY-SK150</b>	<b>B45BY-SKV150</b>	<b>B45BY-TB150</b>
2"	<b>B45BY-RK200</b>	<b>B45BY-SK200</b>	<b>B45BY-SKV200</b>	<b>B45BY-TB200</b>
2½"	<b>B45BY-RK250</b>	<b>B45BY-SK250</b>	<b>B45BY-SKV250</b>	<b>B45BY-TB250</b>
3"	<b>B45BY-RK300</b>	<b>B45BY-SK300</b>	<b>B45BY-SKV300</b>	<b>B45BY-TB300</b>



B45 Air Blow Check Valves



Sanitary Fittings

**Materials:**

- 316L stainless steel
- stem seat and gasket: EPDM

**Features:**

- Conforms to 3A standards for filtration of air entering tanks or pipelines with optional filter disc
- filter discs sold separately in packs of 50

**Specifications:**

- maximum operating temperature: **212°F (100°C)**
- maximum operating pressure: **145 PSI**



Can be used on the Dixon® B45BY Series Y-Ball Check Valves



**Dimensions**

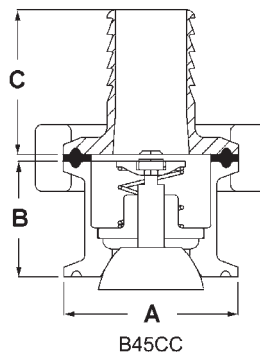
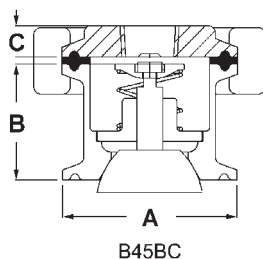
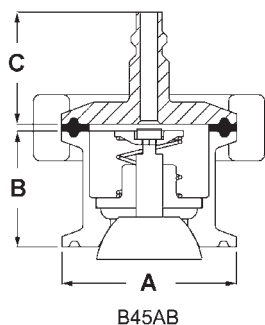

Size	A	B	C Plug	C FNPT	C Hose Barb
1"-1½"	1.984"	1.30"	1.26"	.6"	1.7"
2"	2.516"	1.30"	1.26"	.6"	1.7"
2½"	3.047"	1.30"	1.26"	.6"	1.7"
3"	3.579"	1.30"	1.26"	.6"	1.7"
4"	4.682"	1.30"	1.26"	.6"	1.7"

All dimensions are approximate. Engineering dimensions are available upon request. Specifications are subject to change without notice.

**Repair Kit**

- Repair kit, **B45AB-RK**, contains:
- (1) EPDM / 316L stainless perforated disc
  - (1) 304 stainless spring retainer
  - (1) 304 stainless spring
  - (1) nylon stem guide
  - (1) 316L / EPDM stem and plug

**Sizing Chart**

When using air blow check valves with ball check valves, refer to the sizing chart below.

Ball Check Valve size	Air Blow Check Valve size
1½"	2"
2"	2½"
2½"	3"
3"	4"

## Air &amp; Vacuum Relief Tank Vent Valves

**Applications:**

- When product filling or emptying a tank, this valve is used to relieve pressure or vacuum

**Features:**

- Triple Action:
  - valve relieves pressure as the fluid level rises while filling a tank
  - valve relieves vacuum as the fluid level drops while emptying a tank
  - seals under equal pressure
- stainless steel screen surrounds the entire vacuum and pressure flow area
- other sanitary connections optional
- 1/4" FNPT connection for gas inlet, plug also supplied
- repair kits available

**Materials:**

- 304 stainless steel, EPDM elastomer

**Specifications:**

- vacuum break: 2" water column, 0.1 PSI
- pressure relief: 22" water column, 0.8 PSI
- maximum temperature and pressure rating: **3 PSI @ 70°F (21°C)**
- maximum flow rate: 500 GPM

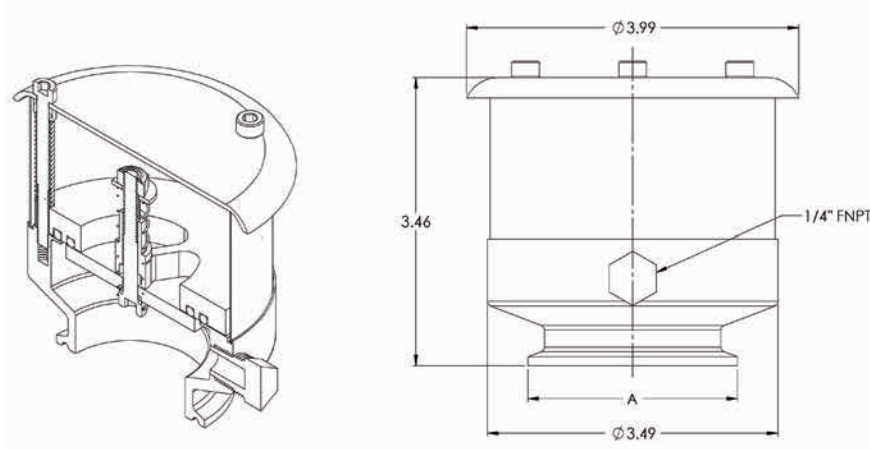

Tube OD	Dimension A	304 Stainless Steel Part #
2"	2.52"	<b>TVSEC-G200</b>
3"	3.58"	<b>TVSEC-G300</b>
4"	4.68"	<b>TVSEC-G400</b>

**!** Due to the impossible determination of whether a tank was damaged due to the tank vent or the lack of opening the upper manhole during product transfer, Dixon Sanitary assumes no liability for tank damage or product loss.

All dimensions are approximate. Engineering dimensions are available upon request.  
Specifications are subject to change without notice.

## Air &amp; Vacuum Relief Tank Vent Valve

**Material:**

- light weight, robust PVC and 304 stainless steel construction

**Features:**

- dome helps in preventing external contamination
- can use any clamp gasket

**Specifications:**

- maximum flow rate: 500 GPM
- vacuum break: 0.1 **PSI**
- pressure relief: 0.1 **PSI**

Size	304 Stainless Steel Part #
2" - 3"	<b>TVPC200-300</b>

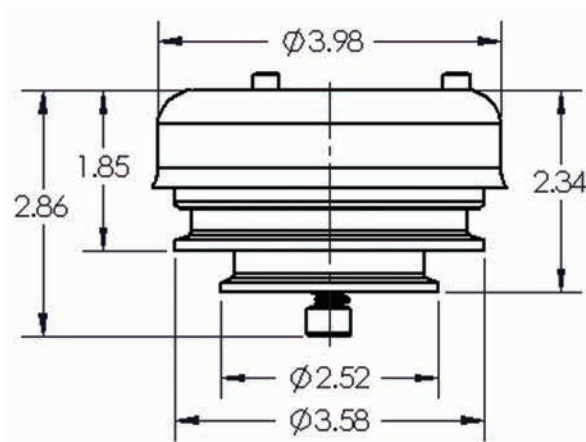
**Dimensions**

**!** Due to the impossible determination of whether a tank was damaged due to the tank vent or the lack of opening the upper manhole during product transfer, Dixon Sanitary assumes no liability for tank damage or product loss.

All dimensions are approximate. Engineering dimensions are available upon request.  
Specifications are subject to change without notice.

## 3A Sample Valves with Manual Handle

### Applications:

- The 3A sample valve allows easy and safe sampling of liquids from closed systems such as vessels and pipelines.
- These valves are located in the pharmaceutical, bio-pharmaceutical, biochemical, cosmetic, food, dairy and beverage markets.

### Features:

- valve body made from solid bar
- no dead space
- drainable
- connections suitable for orbital welding
- available with single or dual ports
- hermetically sealed against environment
- optimum cleanability
- change of seals without special tools
- long life of the PTFE-bellows
- low spare part costs
- options for pneumatic actuator: no lever, with self-closing lever and with lever for open position
- manual actuator (hand wheel)

### Materials:

- In product contact: 1.4404/AISI 316L
- Non product contact: 1.4301/AISI 304
- Product contact seals: PTFE bellows
- Surfaces: wetted product surfaces:  $R_a \leq 32$  (optional surface finishes available). Non product contact:  $R_a \leq 63$

### Specifications:

- Closing tension operating pressure: maximum **116 PSI**
- Hand wheel version operating pressure: minimum **87 PSI**, maximum **232 PSI**
- Controlled air pressure: maximum **145 PSI**



single port



double port

Clamp Valve Size	Weld Port Size	Single Port Part #	Dual Port Part #
½"	¼"	<b>BSVS-HC050B025</b>	<b>BSVD-HC050B025</b>
½"	⅜"	<b>BSVS-HC050B375</b>	<b>BSVD-HC050B375</b>
½"	½"	<b>BSVS-HC050B050</b>	<b>BSVD-HC050B050</b>
1" - 1½"	¼"	<b>BSVS-HC100B025</b>	<b>BSVD-HC100B025</b>
1" - 1½"	⅜"	<b>BSVS-HC100B375</b>	<b>BSVD-HC100B375</b>
1" - 1½"	½"	<b>BSVS-HC100B050</b>	<b>BSVD-HC100B050</b>
2"	¼"	<b>BSVS-HC200B025</b>	<b>BSVD-HC200B025</b>
2"	⅜"	<b>BSVS-HC200B375</b>	<b>BSVD-HC200B375</b>
2"	½"	<b>BSVS-HC200B050</b>	<b>BSVD-HC200B050</b>
2½"	¼"	<b>BSVS-HC250B025</b>	<b>BSVD-HC250B025</b>
2½"	⅜"	<b>BSVS-HC250B375</b>	<b>BSVD-HC250B375</b>
2½"	½"	<b>BSVS-HC250B050</b>	<b>BSVD-HC250B050</b>
3"	¼"	<b>BSVS-HC300B025</b>	<b>BSVD-HC300B025</b>
3"	⅜"	<b>BSVS-HC300B375</b>	<b>BSVD-HC300B375</b>
3"	½"	<b>BSVS-HC300B050</b>	<b>BSVD-HC300B050</b>
4"	¼"	<b>BSVS-HC400B025</b>	<b>BSVD-HC400B025</b>
4"	⅜"	<b>BSVS-HC400B375</b>	<b>BSVD-HC400B375</b>
4"	½"	<b>BSVS-HC400B050</b>	<b>BSVD-HC400B050</b>

## Electrically Actuated Stainless Steel Ball Valves

## 2-Piece

## Features:

## 2-Piece Stainless Steel Ball Valve

- body, ends and ball: CF8M stainless
- seats: RTFE
- seals: PTFE
- blow-out proof stem
- ISO 5211 mounting pad
- pressure rating: ¼" - 2" **1000 PSI WOG**, 2½" - 3" **800 PSI WOG**
- temperature range: ½" to 2": **-40°F to 350°F (-40°C to 177°C)**, 3" to 4": **-40°F to 325°F (-40°C to 163°C)**

## Electric Actuator

- housing: lightweight powder coated aluminum alloy
- NEMA 4/4X waterproof and dustproof
- gear train: high alloy steel
- H-insulation class
- visual position indication
- space heater is standard
- temperature range: **-41°F to 140°F (-41°C to 60°C)**
- ISO 9001, CS, CE and CSA-C US Certified
- RoHS compliant

Sanitary  
Fittings

## 3-Piece

## Features:

## 3-Piece Stainless Steel Ball Valve

- body and ball: CF8M stainless steel
- stem: 316 stainless steel
- seat: RTFE
- blow-out proof stem
- live-loaded stem packing
- ISO 5211 mounting pad
- swing out design allows easy maintenance
- maximum pressure: ¼" - 2" **1,000 PSI WOG** at 65°F, 2½" - 3" **800 PSI WOG** at 65°F, 4" **600 PSI WOG** at 65°F
- temperature range: ½" to 2": **-40°F to 350°F (-40°C to 177°C)**, 3" to 4": **-40°F to 325°F (-40°C to 163°C)**

## Electric Actuator

- housing: lightweight powder coated aluminum alloy
- NEMA 4/4X waterproof and dustproof
- gear train: high alloy steel
- H-insulation class
- visual position indication
- space heater is standard
- temperature range: **-41°F to 140°F (-41°C to 60°C)**
- ISO 9001, CS, CE and CSA-C US Certified
- RoHS compliant



A wide variety of options are available: voltages, modulating, extra switches, transmitters, potentiometer, etc. Contact Dixon Sanitary at 800.789.1718.

Even though there are torque safety factors built into our automated ball valve packages, actual service conditions must also be considered when selecting the proper product for the appropriate application. For example: Severe service conditions such as dirty water, dirty air, all slurries, raw sewage water, oils, and other viscous fluids can have a dramatic affect in raising the torque requirements of ball valves as much as 75% and therefore larger actuators may be required. Please consult Dixon® when dealing with these types of applications.



## Electrically Actuated Brass Ball Valves

Sanitary  
Fittings**Features:****2-Piece Brass Ball Valve**

- ½" to 2" brass; 3" bronze
- elastomers: FKM
- stem: blow-out proof brass
- seats: PTFE with double O-ring stem packing
- ISO 5211 mounting pad
- pressure rating: - **600 PSI WOG, 150 PSI WOG**
- maximum temperature: **300°F (149°C)**

**Electric Actuator**

- housing: lightweight powder coated aluminum alloy
- NEMA 4/4X waterproof and dustproof
- gear train: high alloy steel
- H-insulation class
- visual position indication
- space heater is standard
- temperature range: **-41°F to 140°F (-41°C to 60°C)**
- ISO 9001, CS, CE and CSA-C US Certified
- RoHS compliant

A wide variety of options are available: voltages, modulating, extra switches, transmitters, potentiometer, etc. Contact Dixon Sanitary at 800.789.1718.

Even though there are torque safety factors built into our automated ball valve packages, actual service conditions must also be considered when selecting the proper product for the appropriate application.

For example: Severe service conditions such as dirty water, dirty air, all slurries, raw sewage water, oils, and other viscous fluids can have a dramatic affect in raising the torque requirements of ball valves as much as 75% and therefore larger actuators may be required. Please consult Dixon® when dealing with these types of applications.



## Electrically Actuated 3-Way Ball Valves - 'T / L' Port

## 3-Way Stainless Steel

**Features:****3-Way Stainless Steel Ball Valve**

- body and ball: CF8M stainless steel
- seats and seals: RTFE
- full port with FNPT ends
- blow-out proof stem
- live-loaded stem packing
- ISO 5211 mounting pad
- working pressure: ¼" to 1": **1000 PSI WOG**; 1¼" to 2": **800 PSI WOG**
- maximum temperature: **350°F (177°C)**

**Electric Actuator**

- housing: lightweight powder coated aluminum alloy
- NEMA 4/4X waterproof and dustproof
- gear train: high alloy steel
- H-insulation class
- visual position indication
- space heater is standard
- temperature range: **-41°F to 140°F (-41°C to 60°C)**
- ISO 9001, CS, CE and CSA-C US Certified
- RoHS compliant

Sanitary  
Fittings

## 3-Way Brass

**Features:****3-Way Brass Ball Valve**

- body: brass
- seats: PTFE with O-ring backing
- reduced port ball valves with FNPT ends
- blow-out proof stem
- ISO 5211 mounting pad
- pressure rating: **400 PSI WOG, 100 PSI WSP**
- maximum temperature: **300°F (149°C)**

**Electric Actuator**

- housing: lightweight powder coated aluminum alloy
- NEMA 4/4X waterproof and dustproof
- gear train: high alloy steel
- H-insulation class
- visual position indication
- space heater is standard
- temperature range: **-41°F to 140°F (-41°C to 60°C)**
- ISO 9001, CS, CE and CSA-C US Certified
- RoHS compliant



A flow path needs to be selected at time of order. See page 651 for flow path options.

Customer verification is critical. If flow path needs to be changed after being shipped, labor and shipping charges will apply.

A wide variety of options are available: voltages, modulating, extra switches, transmitters, potentiometer, etc. Contact Dixon Sanitary at 800.789.1718.

Even though there are torque safety factors built into our automated ball valve packages, actual service conditions must also be considered when selecting the proper product for the appropriate application. For example: Severe service conditions such as dirty water, dirty air, all slurries, raw sewage water, oils, and other viscous fluids can have a dramatic affect in raising the torque requirements of ball valves as much as 75% and therefore larger actuators may be required. Please consult Dixon® when dealing with these types of applications.



Pneumatically Actuated Stainless Steel Ball Valves

2-Piece

Features:

3-Piece Stainless Steel Ball Valve

- body, ends and ball: CF8M stainless
- seats: RTFE
- seals: PTFE
- blow-out proof stem
- live-loaded stem packing
- ISO 5211 mounting pad
- pressure rating: ¼" - 2" **1000 PSI WOG**, 2½" - 3" **800 PSI WOG**
- temperature range: ¼" to 2": **-40°F to 350°F (-40°C to 177°C)**, 2½" to 3": **-40°F to 325°F (-40°C to 163°C)**

Rack and Pinion Actuator

- body: hard anodized aluminum
- anti-blowout pinion: nickel plated anti-blowout pinion
- O-rings: Buna-N
- NAMUR mounting
- bi-directional stops for ±5° travel adjustment
- **80 PSI** plant air required
- visual position indication
- maximum operating pressure: **120 PSI**
- temperature range: **-40°F to 200°F (-40°C to 93°C)**
- tested to one million cycles
- for spring return actuators must note fail position

Sanitary Fittings



3-Piece

Features:

3-Piece Stainless Steel Ball Valve

- body and ball: CF8M stainless steel
- stem: 316 stainless steel
- seat: RTFE
- blow-out proof stem
- live-loaded stem packing
- ISO 5211 mounting pad
- swing out design allows easy maintenance
- maximum pressure: ¼" - 2" **1,000 PSI WOG** at 65°F, 2½" - 3" **800 PSI WOG** at 65°F, 4" **600 PSI WOG** at 65°F
- temperature range: ½" to 2" **-40°F to 350°F (-40°C to 177°C)**, 3" to 4": **-40°F to 325°F (-40°C to 163°C)**

Rack and Pinion Actuator

- body: hard anodized aluminum
- anti-blowout pinion: nickel plated
- O-rings: Buna-N
- NAMUR mounting
- bi-directional stops for ±5° travel adjustment
- 80 PSI plant air required
- visual position indication
- maximum operating pressure: **120 PSI**
- temperature range: **-40°F to 200°F (-40°C to 93°C)**
- tested to one million cycles
- for spring return actuators must note fail position



A wide variety of options are available: spring return (normally closed) and double acting actuators, switches, solenoids, positioners, etc. Contact Dixon Sanitary at 800.789.1718.

Even though there are torque safety factors built into our automated ball valve packages, actual service conditions must also be considered when selecting the proper product for the appropriate application. For example: Severe service conditions such as dirty water, dirty air, all slurries, raw sewage water, oils, and other viscous fluids can have a dramatic affect in raising the torque requirements of ball valves as much as 75% and therefore larger actuators may be required. Please consult Dixon® when dealing with these types of applications.





## Pneumatically Actuated Brass Ball Valves

**Features:****2-Piece Brass Ball Valve**

- body: ¼ " to 2" brass, 2½" - 4" bronze
- seats: PTFE
- ends: FNPT
- brass ball
- FKM elastomers
- blow-out proof stem
- PTFE seats with double O-ring stem packing
- ISO 5211 mounting pad
- pressure rating: - **600 PSI WOG, 150 PSI WSP**
- maximum temperature: **300°F (149°C)**

**Rack and Pinion Actuator**

- body: hard anodized aluminum
- anti-blowout pinion: nickel plated
- O-rings: Buna-N
- NAMUR mounting
- bi-directional stops for  $\pm 5^\circ$  travel adjustment
- 80 PSI plant air required
- visual position indication
- maximum operating pressure: **120 PSI**
- temperature range: **-40°F to 200°F (-40°C to 93°C)**
- tested to one million cycles
- for spring return actuators must note fail position

Sanitary  
Fittings

A wide variety of options are available: spring return (normally closed) and double acting actuators, switches, solenoids, positioners, etc. Contact Dixon Sanitary at 800.789.1718.

Even though there are torque safety factors built into our automated ball valve packages, actual service conditions must also be considered when selecting the proper product for the appropriate application. For example: Severe service conditions such as dirty water, dirty air, all slurries, raw sewage water, oils, and other viscous fluids can have a dramatic affect in raising the torque requirements of ball valves as much as 75% and therefore larger actuators may be required. Please consult Dixon® when dealing with these types of applications.



## Pneumatically Actuated 3-Way Stainless Steel Ball Valves - 'T / L' Port

Sanitary  
Fittings



### Features:

#### 3-Way Stainless Steel Ball Valve

- full port ball valves with FNPT ends
- body and ball: CF8M stainless steel
- seats and seals: RTFE
- blow-out proof stem
- live-loaded stem packing
- ISO 5211 mounting pad
- working pressure: ¼" to 1": **1000 PSI WOG**; 1¼" to 2": **800 PSI WSP**
- maximum temperature: **350°F (177°C)**

#### Rack and Pinion Actuator

- body: hard anodized aluminum
  - anti-blowout pinion: nickel plated
  - O-rings: Buna-N
  - NAMUR mounting
  - bi-directional stops for ±5° travel adjustment
  - 80 PSI plant air required
  - visual position indication
  - maximum operating pressure: **120 PSI**
  - temperature range: **-40°F to 200°F (-40° to 93°C)**
  - tested to one million cycles
  - for spring return actuators must note fail position
- A flow path needs to be selected at time of order. See page 651 for flow path options.
  - Customer verification is critical. If flow path needs to be changed after being shipped, labor and shipping charges will apply.

A wide variety of options are available: spring return (normally closed) and double acting actuators, switches, solenoids, positioners, etc. Contact Dixon Sanitary at 800.789.1718.

Even though there are torque safety factors built into our automated ball valve packages, actual service conditions must also be considered when selecting the proper product for the appropriate application.

For example: Severe service conditions such as dirty water, dirty air, all slurries, raw sewage water, oils, and other viscous fluids can have a dramatic affect in raising the torque requirements of ball valves as much as 75% and therefore larger actuators may be required. Please consult Dixon® when dealing with these types of applications.



## Pneumatically Actuated 3-Way Brass Ball Valves - 'T / L' Port

**Features:****3-Way Brass Ball Valve**

- reduced port brass ball valves with FNPT ends
- blow-out proof stem
- body: brass
- seats: PTFE with O-ring backing
- ball: chrome-plated brass
- PTFE seats with O-ring backing for low operating torque
- ISO 5211 mounting pad
- pressure rating: **400 PSI WOG 100 PSI WSP**
- maximum temperature: **300°F (149°C)**

**Rack and Pinion Actuator**

- body: hard anodized aluminum
  - anti-blowout pinion: nickel plated
  - O-rings: Buna-N
  - NAMUR mounting
  - bi-directional stops for  $\pm 5^\circ$  travel adjustment
  - 80 PSI plant air required
  - visual position indication
  - maximum operating pressure: **120 PSI**
  - temperature range: **-40°F to 200°F (-40°C to 93°C)**
  - tested to one million cycles
  - for spring return actuators must note fail position
- A flow path needs to be selected at time of order. See page 651 for flow path options.
  - Customer verification is critical. If flow path needs to be changed after being shipped, labor and shipping charges will apply.

Sanitary  
Fittings

A wide variety of options are available: spring return (normally closed) and double acting actuators, switches, solenoids, positioners, etc. Contact Dixon Sanitary at 800.789.1718.

Even though there are torque safety factors built into our automated ball valve packages, actual service conditions must also be considered when selecting the proper product for the appropriate application. For example: Severe service conditions such as dirty water, dirty air, all slurries, raw sewage water, oils, and other viscous fluids can have a dramatic affect in raising the torque requirements of ball valves as much as 75% and therefore larger actuators may be required. Please consult Dixon® when dealing with these types of applications.



## Pneumatically Actuated Wafer Butterfly Valves

### Rack and Pinion Actuator

#### Features:

- bi-directional stops for  $\pm 5^\circ$  travel adjustment
- **80 PSI** plant air required
- body: hard anodized aluminum
- anti-blowout pinion: nickel plated
- O-rings: Buna-N
- maximum operating pressure: **120 PSI**
- temperature range: **-40°F to 200°F (-40°C to 93°C)**
- Namur mounting
- visual position indication
- tested to 1 million cycles
- for spring return actuators must note fail position

Sanitary  
Fittings

---

### Wafer



#### Features:

- installs between standard ANSI Class 150# flanges
- seat backing ring ensures blow-out proof service
- conforms to MSS-SP-67, MSS-SP-25, API-609
- body with extended neck: ductile iron
- disc: nickel plated ductile iron
- replaceable seat: EPDM
- no taper pins
- can be serviced in the field
- maximum operating pressure: **200 PSI** (bi-directional)
- temperature range: **-20°F to 250°F (-29°C to 121°C)**
- a wide variety of seat, disc and body materials are available

---

### Lug



#### Features:

- installs between standard ANSI Class 150# flanges
- seat backing ring ensures blow-out proof service
- conforms to MSS-SP-67, MSS-SP-25, API-609
- body with extended neck: ductile iron
- disc: nickel plated ductile iron
- replaceable seat: EPDM
- no taper pins
- can be serviced in the field
- maximum operating pressure: **200 PSI** (bi-directional)
- temperature range: **-20°F to 250°F (-29°C to 121°C)**
- a wide variety of seat, disc and body materials are available

A wide variety of options are available: spring return (normally closed) and double acting actuators, switches, solenoids, positioners, etc. Contact Dixon Sanitary at 800.789.1718.



# BV3/4 Series Multi-port Sanitary Stainless Steel Ball Valves

## Flow Paths

3-way 'L'-port  
position A



3-way 'L'-port  
position B



3-way 'L'-port  
position C



3-way 'T'-port  
position A



3-way 'T'-port  
position B



3-way 'T'-port  
position C



3-way 'T'-port  
position D



4-way 'L'-port  
position A



4-way 'L'-port  
position B



4-way 'L'-port  
position C



4-way 'L'-port  
position D



4-way 'T'-port  
position A

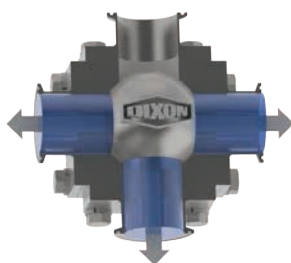

4-way 'T'-port  
position B



4-way 'T'-port  
position C



4-way 'T'-port  
position D

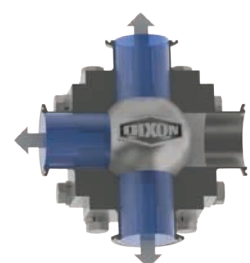

Sanitary  
Fittings



Actuated Valve Accessories

Limit Switches

Features:

- visual position indicator
- 3D open/close indication
- quick-set cam
- mechanical SPDT switches (standard)
- multipoint terminal strip
- various switch options available
- cable entry: (2) 1/2" NPT

Enclosures available:

NEMA 4 4/X

- water and dust tight for indoor or outdoor use
- corrosion resistant

NEMA 7

- water and dust tight for indoor or outdoor use
- corrosion resistant
- for use in indoor hazardous locations
- explosion proof



XLS-B4A0120P

Enclosure	Part #
NEMA 4/4X	<b>XLS-B4A0120P</b>
NEMA 7	<b>XLS-C7A0120P</b>

Solenoids

Features:

- pressure range: **30 PSI to 150 PSI**
- duty cycle: 100% extended duty
- voltages available: 12VDC, 24VDC, 24VAC, 48VAC, 110VAC, 220VAC
- electroless nickel plated spool
- easy-to-use manual override
- port sizes: inlet and exhaust 1/4" NPT
- NEMA 4 4/X Enclosure
  - water and dust tight for indoor or outdoor use
  - corrosion resistant



Description	Voltage	Part #
single coil	115VAC	<b>XSO-4S4D-0A</b>
single coil	24VDC	<b>XSO-4S4B-0A</b>
dual coil	115VAC	<b>XSO-4D4D-0A</b>
dual coil	24VDC	<b>XSO-4D4B-0A</b>

Positioners

Features:

- air capacity:
  - at 29 PSI (200kPa): 9.5 SCFM
  - at 87 PSI (600kPa): 28.3 SCFM
  - at 145 PSI (1MPa): 47.1 SCFM
- air connections: 1/4" NPT
- gauges: 1/8" NPT
- cable entry: 1/2" NPT

Electro-Pneumatic

- input range: 4-20mA (Ri<250ohms)
- supply pressure: 21.8 to 145 PSI (0.15 to 1MPa)
- linearity error: <1.0% f.s
- hysteresis: <0.6% f.s
- repeatability: <0.5% f.s

Pneumatic

- input range: 3 to 15 PSI (20-100kPa)
- supply pressure: < 145 PSI (<1MPa)
- linearity error: <0.7% f.s
- hysteresis: <0.4% f.s
- repeatability: <0.3% f.s



Positioner Type	Part #
Electro-Pneumatic	<b>XPO-E4F</b>
Pneumatic	<b>XPO-P4F</b>

Sanitary Fittings



<b>Threaded Pipe Fittings ..... 654 to 680</b>	<b>Pipe Couplings ..... 686 to 687</b>
NPT threaded bell reducers..... 654 to 655	Straub Grip-L..... 686
Adapters ..... 655	Straub Open-Flex ..... 687
NPT threaded couplings - both ends ..... 656	<b>Flanges &amp; Flange Adapters 688 to 689</b>
Merchant couplings ..... 656	150 lb. ASA..... 688 to 689
Threaded unions..... 657	King™ turned back weld-to-metal hose nipples ..... 689
NPT threaded reducing union..... 657	<b>Grooved Fittings ..... 690 to 702</b>
Hex couplings..... 657	Quick release..... 690
Reducer hex bushings..... 658 to 659	Standard couplings..... 691
Adapters ..... 659	Lightweight flexible ..... 692
Nipples..... 660 to 663	Lite® couplings ..... 693
Pipe..... 660, 661	Rigid couplings ..... 694
Adapters..... 660, 663	Bolted clamps ..... 695
Close..... 661 to 662	Painted iron clamps with Baylast™ gaskets..... 695
Hex..... 662	Mechanical tees..... 696
90° Elbows ..... 664 to 666	Flange adapters..... 697
NPT threaded..... 664, 665	ANSI split flange ..... 697
Female pipe ..... 664	Reducing adapters ..... 697
NPT threaded reducing..... 665	End fittings..... 698
Street ..... 665	Caps ..... 699
NPT threaded street..... 666	Nipples..... 699
45° Elbows ..... 667	Butterfly valves ..... 699
Tees ..... 668 to 670	Gaskets ..... 700
NPT threaded female..... 668	Accessories ..... 701
Female extruded ..... 668	High density polyethylene couplings ..... 702
Reducing tees ..... 669	<b>Line Strainers ..... 703</b>
Street service..... 669	Y line..... 703
Bull head..... 669	Polypropylene T line ..... 703
Side outlet..... 669	<b>LP Gas Fittings..... 704 to 706</b>
Street ..... 670	Adapters ..... 704
Male branch ..... 670	Couplings..... 705
Crosses ..... 670	Gaskets ..... 705
Caps ..... 671	Spanner wrench ..... 705
Plugs..... 672	Caps and plugs..... 706
Schedule 80 plastic fittings ..... 673 to 676	<b>Tube Fittings ..... 707 to 730</b>
Tuff-Lite™ plastic fittings ..... 673 to 676	Instrumentation..... 707 to 710
Bulkhead..... 677	Compression ..... 711 to 716
Bolted fittings..... 678	Brass SAE 45° flare..... 717 to 719
Swage nipples ..... 679	Flareless bite ..... 720 to 722
Bull plugs..... 680	Sharkbite® push to connect ..... 723 to 724
<b>Hammer Unions ..... 681 to 683</b>	LIQUIfit™ ..... 725 to 728
Series 100, 200, 206, 400, 602, 1002, 1502 ..... 681 to 683	TrueSeal™ ball valves..... 729 to 730
Hookie hook hose lifters ..... 683	
<b>Weld to Metal Hose Fittings ..... 684</b>	
<b>Wrench Grips..... 685</b>	

## NPT Threaded Bell Reducers

## Features:

- other sizes available
- 304 stainless steel fittings are also available, consult Dixon® for pricing and availability

Female NPT	Female NPT	300# Iron Part #	150# Iron Part #	150# Galvanized Iron Part #
1/4"	1/8"	---	<b>BR1418</b>	---
3/8"	1/8"	---	<b>BR3818</b>	---
	1/4"	---	<b>BR3825</b>	---
1/2"	1/4"	<b>300BR5025</b>	<b>BR5025</b>	<b>BR5025G</b>
	3/8"	---	<b>BR5038</b>	<b>BR5038G</b>
3/4"	1/4"	---	<b>BR7525</b>	---
	3/8"	---	<b>BR7538</b>	---
	1/2"	<b>300BR7550</b>	<b>BR7550</b>	<b>BR7550G</b>
1"	1/4"	---	<b>BR1025</b>	---
	3/8"	---	<b>BR1038</b>	---
	1/2"	---	<b>BR1050</b>	<b>BR1050G</b>
	3/4"	<b>300BR1075</b>	<b>BR1075</b>	<b>BR1075G</b>
1 1/4"	1/2"	---	<b>BR1250</b>	---
	3/4"	---	<b>BR1275</b>	---
	1"	<b>300BR1210</b>	<b>BR1210</b>	<b>BR1210G</b>
1 1/2"	3/4"	---	<b>BR1575</b>	---
	1"	<b>300BR1510</b>	<b>BR1510</b>	<b>BR1510G</b>
	1 1/4"	<b>300BR1512</b>	<b>BR1512</b>	<b>BR1512G</b>
2"	3/4"	---	<b>BR2075</b>	---
	1"	<b>300BR2010</b>	<b>BR2010</b>	<b>BR2010G</b>
	1 1/4"	<b>300BR2012</b>	<b>BR2012</b>	---
	1 1/2"	<b>300BR2015</b>	<b>BR2015</b>	<b>BR2015G</b>
2 1/2"	1"	---	<b>BR2510</b>	---
	1 1/2"	---	<b>BR2515</b>	---
	2"	---	<b>BR2520</b>	<b>BR2520G</b>
3"	1"	---	<b>BR3010</b>	---
	1 1/4"	---	<b>BR3012</b>	---
	1 1/2"	---	<b>BR3015</b>	---
	2"	---	<b>BR3020</b>	<b>BR3020G</b>
	2 1/2"	---	<b>BR3025</b>	<b>BR3025G</b>
4"	1"	---	<b>BR4010</b>	---
	1 1/2"	---	<b>BR4015</b>	---
	2"	---	<b>BR4020</b>	---
	2 1/2"	---	<b>BR4025</b>	---
	3"	---	<b>BR4030</b>	<b>BR4030G</b>
6"	3"	---	<b>BR6030</b>	---
	4"	---	<b>BR6040</b>	---



300# iron



150# iron



150# galvanized iron

- For additional information on pipe dimensions please reference [dixonvalve.com](http://dixonvalve.com).



NPT Threaded Bell Reducers

Features:

- other sizes available
- 304 stainless steel fittings are also available, consult Dixon® for pricing and availability

Female NPT	Female NPT	150# 316 Stain.Steel Part #	3000# Forged Steel Part #	125# Brass Part #
1/4"	1/8"	---	---	---
3/8"	1/8"	---	---	---
	1/4"	<b>BR3825SS</b>	---	---
1/2"	1/4"	<b>BR5025SS</b>	---	---
	3/8"	<b>BR5038SS</b>	<b>BR5038FS</b>	<b>BR5038B<sup>1</sup></b>
3/4"	3/8"	<b>BR7538SS</b>	---	<b>3771206C</b>
	1/2"	<b>BR7550SS</b>	<b>BR7550FS</b>	<b>BR7550B<sup>1</sup></b>
1"	1/2"	<b>BR1050SS</b>	---	<b>BR1050B</b>
	3/4"	<b>BR1075SS</b>	<b>BR1075FS</b>	<b>BR1075B</b>
1 1/4"	1"	<b>BR1210SS</b>	---	<b>BR1210B</b>
1 1/2"	3/4"	---	---	<b>BR1575B</b>
	1"	<b>BR1510SS</b>	<b>BR1510FS</b>	<b>BR1510B</b>
	1 1/4"	<b>BR1512SS</b>	<b>BR1512FS</b>	---
2"	1"	<b>BR2010SS</b>	<b>BR2010FS</b>	<b>BR2010B</b>
	1 1/2"	<b>BR2015SS</b>	<b>BR2015FS</b>	<b>BR2015B</b>
2 1/2"	2"	---	---	<b>BR2520B</b>
3"	2"	<b>BR3020SS</b>	---	<b>BR3020B</b>
4"	3"	---	---	<b>BR4030B</b>

<sup>1</sup> items will be discontinued as stock is depleted



150# 316 stainless steel



3000# forged steel



125# brass

Pipe, Welding & Tube Fittings

Adapters  
Reducer Couplings

Feature:

- ref SAE 130138

Female NPTF	Brass		Optional Qty	Lead Free Brass <sup>1,2,3</sup>
	Previous Part #	Part #		Part #
1/4" x 1/8"	RC2F1F	<b>3770402C</b>	50	---
3/8" x 1/8"	RC3F1F	<b>3770602C</b>	50	---
3/8" x 1/4"	RC3F2F	<b>3770604C</b>	50	---
1/2" x 1/4"	RC4F2F	<b>3770804C</b>	25	---
1/2" x 3/8"	RC4F3F	<b>3770806C</b>	10	<b>3770806CLF</b>
3/4" x 3/8"	RC6F3F	<b>3771206C</b>	10	---
3/4" x 1/2"	RC6F4F	<b>3771208C</b>	10	<b>3771208CLF</b>



<sup>1</sup> lead free brass <=0.25% lead; Alloy CA2745; Alloy C46400  
<sup>2</sup> conforms To: Safe Water Drinking Act (SWDA) of Jan. 4, 2014; California AB1953; RoHS Compliant  
<sup>3</sup> NPT threads

• For additional information on pipe dimensions please reference [dixonvalve.com](http://dixonvalve.com).

NPT Threaded Couplings



300# iron



150# iron



150# galvanized iron



150# 316 stainless steel



3000# forged steel



125# brass

Female NPT	300# Iron Part #	150# Iron Part #	150# Galvanized Iron Part #
1/8"	---	<b>RHC18</b>	<b>RHC18G</b>
1/4"	<b>300RHC25</b>	<b>RHC25</b>	<b>RHC25G</b>
3/8"	<b>300RHC38</b>	<b>RHC38</b>	<b>RHC38G</b>
1/2"	<b>300RHC50</b>	<b>RHC50</b>	<b>RHC50G</b>
3/4"	<b>300RHC75</b>	<b>RHC75</b>	<b>RHC75G</b>
1"	<b>300RHC100</b>	<b>RHC100</b>	<b>RHC100G</b>
1 1/4"	<b>300RHC125</b>	<b>RHC125</b>	<b>RHC125G</b>
1 1/2"	<b>300RHC150</b>	<b>RHC150</b>	<b>RHC150G</b>
2"	<b>300RHC200</b>	<b>RHC200</b>	<b>RHC200G</b>
2 1/2"	---	<b>RHC250</b>	---
3"	---	<b>RHC300</b>	<b>RHC300G</b>
4"	---	<b>RHC400</b>	<b>RHC400G</b>
5"	---	<b>RHC500</b>	---
6"	---	<b>RHC600</b>	---

Female NPT	150# 316 Stain.Steel Part #	3000# Forged Steel Part #	125# Brass Part #
1/4"	<b>RHC25SS</b>	<b>RHC25FS</b>	<b>RHC25B</b>
3/8"	<b>RHC38SS</b>	<b>RHC38FS</b>	<b>RHC38B</b>
1/2"	<b>RHC50SS</b>	<b>RHC50FS</b>	<b>RHC50B</b>
3/4"	<b>RHC75SS</b>	<b>RHC75FS</b>	<b>RHC75B</b>
1"	<b>RHC100SS</b>	<b>RHC100FS</b>	<b>RHC100B</b>
1 1/4"	<b>RHC125SS</b>	<b>RHC125FS</b>	<b>RHC125B</b>
1 1/2"	<b>RHC150SS</b>	<b>RHC150FS</b>	<b>RHC150B</b>
2"	<b>RHC200SS</b>	<b>RHC200FS</b>	<b>RHC200B</b>
3"	<b>RHC300SS</b>	---	---
4"	<b>RHC400SS</b>	---	---

Merchant Couplings

- other sizes are also available, consult Dixon® for pricing



Female NPSM	Black Iron Part #
1/4"	<b>MRCH25</b>
3/8"	<b>MRCH38</b>
1/2"	<b>MRCH50</b>
3/4"	<b>MRCH75</b>
1"	<b>MRCH100</b>
1 1/4"	<b>MRCH125</b>
1 1/2"	<b>MRCH150</b>
2"	<b>MRCH200</b>
3"	<b>MRCH300<sup>1</sup></b>

<sup>1</sup> has female NPT thread

- For additional information on pipe dimensions please reference [dixonvalve.com](http://dixonvalve.com).

NPT Threaded Unions

Features:

- other sizes are also available
- 304 stainless steel fittings are also available, consult Dixon® for pricing and availability

Female NPT	300# Iron Part #	150# Iron Part #	150# Galvanized Iron Part #
1/8"	---	<b>MIU18</b>	---
1/4"	---	<b>MIU25</b>	---
3/8"	---	<b>MIU38</b>	<b>TUN038G</b>
1/2"	<b>300MIU50</b>	<b>MIU50</b>	<b>TUN050G</b>
3/4"	<b>300MIU75</b>	<b>MIU75</b>	<b>TUN075G</b>
1"	<b>300MIU100</b>	<b>MIU100</b>	<b>TUN100G</b>
1 1/4"	---	<b>MIU125</b>	<b>TUN125G</b>
1 1/2"	<b>300MIU150</b>	<b>MIU150</b>	<b>TUN150G</b>
2"	---	<b>MIU200</b>	<b>TUN200G</b>
2 1/2"	---	<b>MIU250</b>	---
3"	<b>300MIU300</b>	<b>MIU300</b>	---
4"	---	<b>MIU400</b>	---



300# iron



150# iron



150# galvanized iron



150# 316 stainless steel



3000# forged steel



brass

Female NPT	150# 316 Stainless Steel Part #	3000# Forged Steel Part #	125# Brass Part #
1/4"	<b>TUN025SS</b>	---	<b>TUN2F</b>
3/8"	<b>TUN038SS</b>	---	<b>TUN3F</b>
1/2"	<b>TUN050SS</b>	<b>TUN050FS</b>	<b>TUN4F</b>
3/4"	<b>TUN075SS</b>	<b>TUN075FS</b>	<b>TUN5F</b>
1"	<b>TUN100SS</b>	<b>TUN100FS</b>	<b>TUN6F</b>
1 1/4"	<b>TUN125SS</b>	---	<b>TUN7F</b>
1 1/2"	<b>TUN150SS</b>	<b>TUN150FS</b>	<b>TUN8F</b>
2"	<b>TUN200SS</b>	<b>TUN200FS</b>	<b>TUN9F</b>

Pipe, Welding & Tube Fittings

NPT Threaded Reducing Union

Female NPT	Female NPT	150# Iron Part #
3/4"	1/2"	<b>MIRU7550</b>



K

Female Hex Couplings

Feature:

- ref SAE 130138

NPTF	Brass		Pkg Qty	Lead Free Brass <sup>1,2,3</sup>
	Previous Part #	Part #		Part #
1/8" x 1/8"	BA1F1F	<b>3710202C</b>	25	<b>3710202CLF</b>
1/4" x 1/4"	BA2F2F	<b>3710404C</b>	25	<b>3710404CLF</b>
3/8" x 3/8"	BA3F3F	<b>3710606C</b>	25	<b>3710606CLF</b>
1/2" x 1/2"	BA4F4F	<b>3710808C</b>	25	<b>3710808CLF</b>
3/4" x 3/4"	BA6F6F	<b>3711212C</b>	10	---



<sup>1</sup> lead free brass <=0.25% lead; Alloy CA2745; Alloy C46400  
<sup>2</sup> conforms To: Safe Water Drinking Act (SWDA) of Jan. 4, 2014; California AB1953; RoHS Compliant  
<sup>3</sup> NPT threads

• For additional information on pipe dimensions please reference [dixonvalve.com](http://dixonvalve.com).

NPT Threaded Reducer Hex Bushings

Male NPT	Female NPT	150# Iron Part #	150# Galvanized Iron Part #	150# 316 Stainless Steel Part #
1/4"	1/8"	<b>HB2518</b>	<b>HB2518G</b>	<b>HB2518SS</b>
3/8"	1/8"	<b>HB3818</b>	---	---
	1/4"	<b>HB3825</b>	<b>HB3825G</b>	<b>HB3825SS</b>
1/2"	1/8"	<b>HB5018</b>	---	---
	1/4"	<b>HB5025</b>	<b>HB5025G</b>	<b>HB5025SS</b>
	3/8"	<b>HB5038</b>	<b>HB5038G</b>	<b>HB5038SS</b>
3/4"	1/8"	<b>HB7518</b>	---	---
	1/4"	<b>HB7525</b>	<b>HB7525G</b>	<b>HB7525SS</b>
	3/8"	<b>HB7538</b>	<b>HB7538G</b>	<b>HB7538SS</b>
	1/2"	<b>HB7550</b>	<b>HB7550G</b>	<b>HB7550SS</b>
1"	1/8"	<b>HB1018</b>	---	---
	1/4"	<b>HB1025</b>	<b>HB1025G</b>	<b>HB1025SS</b>
	3/8"	<b>HB1038</b>	<b>HB1038G</b>	<b>HB1038SS</b>
	1/2"	<b>HB1050</b>	<b>HB1050G</b>	<b>HB1050SS</b>
	3/4"	<b>HB1075</b>	<b>HB1075G</b>	<b>HB1075SS</b>
1 1/4"	1/2"	<b>HB1250</b>	---	---
	3/4"	<b>HB1275</b>	---	<b>HB1275SS</b>
	1"	<b>HB1210</b>	<b>HB1210G</b>	<b>HB1210SS</b>
1 1/2"	1/2"	<b>HB1550</b>	---	---
	3/4"	<b>HB1575</b>	<b>HB1575G</b>	<b>HB1575SS</b>
	1"	<b>HB1510</b>	<b>HB1510G</b>	<b>HB1510SS</b>
	1 1/4"	<b>HB1512</b>	<b>HB1512G</b>	<b>HB1512SS</b>
2"	1/2"	<b>HB2050</b>	<b>HB2050G</b>	---
	3/4"	<b>HB2075</b>	<b>HB2075G</b>	<b>HB2075SS</b>
	1"	<b>HB2010</b>	<b>HB2010G</b>	<b>HB2010SS</b>
	1 1/4"	<b>HB2012</b>	<b>HB2012G</b>	<b>HB2012SS</b>
	1 1/2"	<b>HB2015</b>	<b>HB2015G</b>	<b>HB2015SS</b>
2 1/2"	1 1/2"	<b>HB2515</b>	---	---
	2"	<b>HB2520</b>	<b>HB2520G</b>	<b>HB2520SS</b>
3"	1"	<b>HB3010</b>	---	---
	1 1/2"	<b>HB3015</b>	---	---
	2"	<b>HB3020</b>	<b>HB3020G</b>	<b>HB3020SS</b>
	2 1/2"	<b>HB3025</b>	---	<b>HB3025SS</b>
4"	1"	<b>HB4010</b>	---	---
	1 1/2"	<b>HB4015</b>	---	---
	2"	<b>HB4020</b>	<b>HB4020G</b>	<b>HB4020SS</b>
	2 1/2"	<b>HB4025</b>	---	---
	3"	<b>HB4030</b>	<b>HB4030G</b>	<b>HB4030SS</b>
5"	4"	<b>HB5040</b>	---	---
6"	3"	<b>HB6030</b>	---	---
	4"	<b>HB6040</b>	---	---

Male NPT	Female NPT	3000# Forged Steel Part #	125# Brass Part #
1/4"	1/8"	<b>HB2518FS</b>	---
3/8"	1/8"	---	---
	1/4"	<b>HB3825FS</b>	---
1/2"	1/8"	---	---
	1/4"	<b>HB5025FS</b>	---
	3/8"	<b>HB5038FS</b>	---
3/4"	1/8"	---	---
	1/4"	<b>HB7525FS</b>	---
	3/8"	<b>HB7538FS</b>	---
	1/2"	<b>HB7550FS</b>	---
1"	1/4"	<b>HB1025FS</b>	---
	3/8"	<b>HB1038FS</b>	---
	1/2"	<b>HB1050FS</b>	---
	3/4"	<b>HB1075FS</b>	---
1 1/4"	3/4"	<b>HB1275FS</b>	---
	1"	<b>HB1210FS</b>	<b>HB1210B</b>
1 1/2"	3/4"	<b>HB1575FS</b>	<b>HB1575B</b>
	1"	<b>HB1510FS</b>	<b>HB1510B</b>
	1 1/4"	<b>HB1512FS</b>	<b>HB1512B</b>
2"	1/2"	---	<b>HB2050B</b>
	3/4"	<b>HB2075FS</b>	<b>HB2075B</b>
	1"	<b>HB2010FS</b>	<b>HB2010B</b>
	1 1/4"	<b>HB2012FS</b>	<b>HB2012B</b>
	1 1/2"	<b>HB2015FS</b>	<b>HB2015B</b>
2 1/2"	1 1/2"	---	<b>HB2515B</b>
	2"	<b>HB2520FS</b>	<b>HB2520B</b>
3"	2"	<b>HB3020FS</b>	<b>HB3020B</b>
	2 1/2"	<b>HB3025FS</b>	<b>HB3025B</b>
4"	2"	---	<b>HB4020B</b>
	3"	<b>HB4030FS</b>	<b>HB4030B</b>

• For additional information on pipe dimensions please reference [dixonvalve.com](http://dixonvalve.com).



150# iron



150# galvanized iron



150# 316 stainless steel

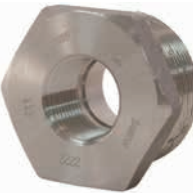

3000# forged steel



125# brass

Reducer Hex Bushings

Feature:

- ref SAE 130140

Female NPTF	Male NPTF	Brass		Optional Qty	Lead Free Brass <sup>2,3,4</sup> Part #
		Previous Part #	Part #		
1/8"	1/4"	HB1F2M	<b>3730402C</b>	100	<b>3730402CLF</b>
1/8"	3/8"	HB1F3M	<b>3730602C</b>	100	---
1/4"		HB2F3M	<b>3730604C</b>	100	<b>3730604CLF</b>
1/8"	1/2"	HB1F4M	<b>3730802C</b>	25	---
1/4"		HB2F4M	<b>3730804C</b>	50	<b>3730804CLF</b>
3/8"		HB3F4M	<b>3730806C</b>	50	<b>3730806CLF</b>
1/8"	3/4"	HB1F6M	<b>3731202C</b> <sup>1</sup>	25	---
1/4"		HB2F6M	<b>3731204C</b>	25	---
3/8"		HB3F6M	<b>3731206C</b>	25	---
1/2"		HB4F6M	<b>3731208C</b>	25	<b>3731208CLF</b>
1/4"	1"	HB2F8M	<b>3731604C</b> <sup>1</sup>	10	---
3/8"		HB3F8M	<b>3731606C</b> <sup>1</sup>	10	---
1/2"		HB4F8M	<b>3731608C</b>	10	---
3/4"		HB6F8M	<b>3731612C</b>	10	---

<sup>1</sup> SAE does not provide a standard for these sizes

<sup>2</sup> lead free brass <=0.25% lead; Alloy CA2745; Alloy C46400

<sup>3</sup> conforms To: Safe Water Drinking Act (SWDA) of Jan. 4, 2014; California AB1953; RoHS Compliant

<sup>4</sup> NPT threads



Pipe, Welding & Tube Fittings

Adapters

Female NPTF x Male NPTF

Feature:

- ref SAE 130139

Female NPTF	Male NPTF	Brass		Optional Qty	Lead Free Brass <sup>1,2,3</sup> Part #
		Previous Part #	Part #		
1/8"	1/8"	RA1F1M	<b>3750202C</b>	100	---
1/4"	1/4"	RA2F1M	<b>3750402C</b>	50	<b>3750402CLF</b>
		RA2F2M	<b>3750404C</b>	50	<b>3750404CLF</b>
3/8"	1/8"	RA3F1M	<b>3750602C</b>	50	---
	1/4"	RA3F2M	<b>3750604C</b>	50	<b>3750604CLF</b>
	3/8"	RA3F3M	<b>3750606C</b>	50	---
1/2"	1/4"	RA4F2M	<b>3750804C</b>	25	---
	3/8"	RA4F3M	<b>3750806C</b>	25	---
	1/2"	RA4F4M	<b>3750808C</b>	25	<b>3750808CLF</b>
3/4"	3/8"	RA6F3M	<b>3751206C</b>	10	---
	1/2"	RA6F4M	<b>3751208C</b>	10	---
	3/4"	RA6F6M	<b>3751212C</b>	10	<b>3751212CLF</b>

<sup>1</sup> lead free brass <=0.25% lead; Alloy CA2745; Alloy C46400

<sup>2</sup> conforms To: Safe Water Drinking Act (SWDA) of Jan. 4, 2014; California AB1953; RoHS Compliant

<sup>3</sup> NPT threads



Pump Adapters

Features:

- used to convert BSP pump outlets to NPT
- hard-coated, extruded 6061-T6 aircraft aluminum alloy
- other sizes, configurations are available, contact Dixon®

Female BSP	Male NPT	Aluminum Part #
1 1/2"	1 1/2"	<b>AHA15BSP15T</b>
2"	2"	<b>AHA20BSP20T</b>
2 1/2"	2 1/2"	<b>AHA25BSP25T</b>
3"	3"	<b>AHA30BSP30T</b>
4"	4"	<b>AHA40BSP40T</b>



- For additional information on pipe dimensions please reference [dixonvalve.com](http://dixonvalve.com).

## Pipe Nipples

## Long Pipe Nipples

- carbon steel and stainless steel nipples are available on page 661



NPT	Length	Brass		Optional Qty	Lead Free Brass <sup>1,2</sup> Part #
		Previous Part #	Part #		
1/8"	1 1/2"	166-0215	<b>1660215C</b>	25	---
	2"	166-0220	<b>1660220C</b>	25	---
	2 1/2"	166-0225	<b>1660225C</b>	25	---
	3"	166-0230	<b>1660230C</b>	25	<b>1660230CLF</b>
	3 1/2"	166-0235	<b>1660235C</b>	10	---
	4"	166-0240	<b>1660240C</b>	10	<b>1660240CLF</b>
1/4"	1 1/2"	166-0415	<b>1660415C</b>	25	<b>1660415CLF</b>
	2"	166-0420	<b>1660420C</b>	25	<b>1660420CLF</b>
	2 1/2"	166-0425	<b>1660425C</b>	25	---
	3"	166-0430	<b>1660430C</b>	25	<b>1660430CLF</b>
	3 1/2"	166-0435	<b>1660435C</b>	10	---
	4"	166-0440	<b>1660440C</b>	10	<b>1660440CLF</b>
3/8"	1 1/2"	166-0615	<b>1660615C</b>	25	<b>1660615CLF</b>
	2"	166-0620	<b>1660620C</b>	25	<b>1660620CLF</b>
	2 1/2"	166-0625	<b>1660625C</b>	10	<b>1660625CLF</b>
	3"	166-0630	<b>1660630C</b>	10	<b>1660630CLF</b>
	3 1/2"	166-0635	<b>1660635C</b>	10	---
	4"	166-0640	<b>1660640C</b>	5	<b>1660640CLF</b>
1/2"	1 1/2"	166-0815	<b>1660815C</b>	10	<b>1660815CLF</b>
	2"	166-0820	<b>1660820C</b>	10	---
	2 1/2"	166-0825	<b>1660825C</b>	10	---
	3"	166-0830	<b>1660830C</b>	10	---
	3 1/2"	166-0835	<b>1660835C</b>	10	---
	4"	166-0840	<b>1660840C</b>	5	---
3/4"	2"	166-1220	<b>1661220C</b>	5	---
	2 1/2"	166-1225	<b>1661225C</b>	5	---
	3"	166-1230	<b>1661230C</b>	5	---
	3 1/2"	166-1235	<b>1661235C</b>	5	---
1"	2"	---	<b>TN100X2B</b>	---	---
	3"	---	<b>TN100X3B</b>	---	---
	4"	---	<b>TN100X4B</b>	---	---
1 1/2"	2"	---	<b>TN150X2B</b>	---	---
	3"	---	<b>TN150X3B</b>	---	---
2"	3"	---	<b>TN200X3B</b>	---	---
	4"	---	<b>TN200X4B</b>	---	---
	6"	---	<b>TN200X6B</b>	---	---

<sup>1</sup> lead free brass <=0.25% lead; Alloy CA2745; Alloy C46400

<sup>2</sup> conforms To: Safe Water Drinking Act (SWDA) of Jan. 4, 2014; California AB1953; RoHS Compliant

## Female NPTF x Male NPSM Adapters



Female NPTF	Male NPSM	Brass		Optional Qty
		Previous Part #	Part #	
1/4"	1/4"	174-0404	<b>1740404C</b>	100
3/8"	3/8"	174-0606	<b>1740606C</b>	50
1/2"	1/2"	174-0808	<b>1740808C</b>	50

- For additional information on pipe dimensions please reference [dixonvalve.com](http://dixonvalve.com).

Pipe Nipples - Threaded Both Ends

Features:

- made from schedule 40 welded pipe
- male NPT x male NPT design
- brass nipples are available, see page 666
- other lengths are also available, consult Dixon® for pricing

Note: do not use pipe nipples as hose inserts. 

Male NPT	Overall Length	Carbon Steel Part #	316 Stainless Steel Part #
1/4"	2"	<b>TN025X2</b>	---
	6"	---	<b>TN025X6SS</b>
3/8"	2"	<b>TN038X2</b>	---
	4"	<b>TN038X4</b>	---
	6"	<b>TN038X6</b>	---
1/2"	2"	<b>TN050X2</b>	<b>TN050X2SS</b>
	3"	<b>TN050X3</b>	<b>TN050X3SS</b>
	4"	<b>TN050X4</b>	<b>TN050X4SS</b>
	6"	<b>TN050X6</b>	<b>TN050X6SS</b>
3/4"	2"	<b>TN075X2</b>	<b>TN075X2SS</b>
	3"	<b>TN075X3</b>	<b>TN075X3SS</b>
	4"	<b>TN075X4</b>	<b>TN075X4SS</b>
	6"	<b>TN075X6</b>	<b>TN075X6SS</b>
1"	2"	<b>TN100X2</b>	<b>TN100X2SS</b>
	3"	<b>TN100X3</b>	<b>TN100X3SS</b>
	4"	<b>TN100X4</b>	<b>TN100X4SS</b>
	6"	<b>TN100X6</b>	<b>TN100X6SS</b>
1 1/4"	2"	<b>TN125X2</b>	<b>TN125X2SS</b>
	3"	<b>TN125X3</b>	<b>TN125X3SS</b>
	4"	<b>TN125X4</b>	<b>TN125X4SS</b>
	6"	<b>TN125X6</b>	<b>TN125X6SS</b>
1 1/2"	2"	<b>TN150X2</b>	<b>TN150X2SS</b>
	3"	<b>TN150X3</b>	<b>TN150X3SS</b>
	4"	<b>TN150X4</b>	<b>TN150X4SS</b>
	6"	<b>TN150X6</b>	<b>TN150X6SS</b>
2"	3"	<b>TN200X3</b>	<b>TN200X3SS</b>
	4"	<b>TN200X4</b>	<b>TN200X4SS</b>
	5"	<b>TN200X5</b>	<b>TN200X5SS</b>
	6"	<b>TN200X6</b>	<b>TN200X6SS</b>
	8"	<b>TN200X8</b>	---
3"	3"	<b>TN300X3</b>	<b>TN300X3SS</b>
	4"	<b>TN300X4</b>	<b>TN300X4SS</b>
	6"	<b>TN300X6</b>	<b>TN300X6SS</b>
4"	4"	<b>TN400X4</b>	<b>TN400X4SS</b>
	6"	<b>TN400X6</b>	<b>TN400X6SS</b>
	8"	<b>TN400X8</b>	---
6"	6"	<b>TN600X6</b>	---
	8"	<b>TN600X8</b>	---



carbon steel



stainless steel

Close Pipe Nipples

NPT	Brass		Optional Qty	Lead Free Brass <sup>1,2</sup>
	Previous Part #	Part #		Part #
1/8"	165-0202	<b>1650202C</b>	50	<b>1650202CLF</b>
1/4"	165-0404	<b>1650404C</b>	50	<b>1650404CLF</b>
3/8"	165-0606	<b>1650606C</b>	100	<b>1650606CLF</b>
1/2"	165-0808	<b>1650808C</b>	25	<b>1650808CLF</b>
3/4"	165-1212	<b>1651212C</b>	25	<b>1651212CLF</b>
1"	165-1616	<b>1651616C</b>	25	---
1 1/2"	---	<b>CN150B</b>	5	---
2"	---	<b>CN200B</b>	5	---
3"	---	<b>CN300B</b>	5	---



<sup>1</sup> lead free brass <=0.25% lead; Alloy CA2745; Alloy C46400

<sup>2</sup> conforms To: Safe Water Drinking Act (SWDA) of Jan. 4, 2014; California AB1953; RoHS Compliant

• For additional information on pipe dimensions please reference [dixonvalve.com](http://dixonvalve.com).

Close Nipples

Features:

- made from schedule 40 welded pipe
- male NPT x male NPT design

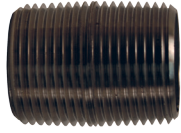

Male NPT	Overall Length	Carbon Steel Part #	Galvanized Part #	316 Stainless Steel Part #	Optional Qty
1/8"	3/4"	---	---	CN012SS	1
1/4"	7/8"	CN025	CN025G	CN025SS	25
3/8"	1"	CN037	---	CN037SS	25
1/2"	1 1/8"	CN050	CN050G	CN050SS	10
3/4"	1 3/8"	CN075	CN075G	CN075SS	10
1"	1 1/2"	CN100	CN100G	CN100SS	10
1 1/4"	1 5/8"	CN125	---	---	10
1 1/2"	1 1/2"	CN150	CN150G	CN150SS	10
2"	2"	CN200	CN200G	CN200SS	10
2 1/2"	2 1/2"	CN250	---	---	--
3"	2 5/8"	CN300	CN300G	CN300SS	1
4"	2 5/8"	CN400	---	CN400SS	5
6"	3 1/8"	CN600	---	---	--

Hex Nipples

Feature:

- ref SAE 130137



NPTF	Brass		Optional Qty	Lead Free Brass <sup>1,2,3</sup> Part #
	Previous Part #	Part #		
1/8" x 1/8"	BCN12	3700202C	100	3700202CLF
1/4" x 1/4"	BCN25	3700404C	100	3700404CLF
3/8" x 3/8"	BCN37	3700606C	50	3700606CLF
1/2" x 1/2"	BCN50	3700808C	25	3700808CLF
3/4" x 3/4"	BCN75	3701212C	20	---
1" x 1"	BCN100	3701616C	10	---

<sup>1</sup> lead free brass <=0.25% lead; Alloy CA2745; Alloy C46400

<sup>2</sup> conforms To: Safe Water Drinking Act (SWDA) of Jan. 4, 2014; California AB1953; RoHS Compliant

<sup>3</sup> NPT threads

Straight Hex Nipples



Male NPT	316 Stainless Steel Part #
3/8"	HN38SS
1/2"	HN50SS
3/4"	HN75SS
1"	HN100SS
1 1/2"	HN150SS
2"	HN200SS

Reducer Hex Nipples

Feature:

- ref SAE 130137



Male NPTF	Brass		Optional Qty
	Previous Part #	Part #	
1/4" x 1/8"	HN2M1M	3790402C	100
3/8" x 1/8"	HN3M1M	3790602C	50
3/8" x 1/4"	HN3M2M	3790604C	50
1/2" x 1/4"	HN4M2M	3790804C	50
1/2" x 3/8"	HN4M3M	3790806C	50
3/4" x 1/2"	HN6M4M	3791208C	25



Male NPT	Male NPT	316 Stainless Steel Part #
3/8"	1/4"	RHN3825SS
1/2"	3/8"	RHN5038SS
3/4"	1/2"	RHN7550SS

Note: do not use pipe nipples as hose inserts.



- For additional information on pipe dimensions please reference dixonvalve.com.



Adapters

Ball Seat to Male Pipe

NPSM	NPTF	Brass		Optional Qty
		Previous Part #	Part #	
1/8"	1/8"	BSM11	<b>1720202C</b>	100
1/4"	1/8"	BSM21	<b>1720402C</b>	100
	1/4"	BSM22	<b>1720404C</b>	100
3/8"	1/4"	BSM32	<b>1720604C</b>	100
	3/8"	BSM33	<b>1720606C</b>	50
	1/2"	BSM34	<b>1720608C</b>	50
1/2"	3/8"	BSM43	<b>1720806C</b>	50
	1/2"	BSM44	<b>1720808C</b>	50
3/4"	3/4"	BSM66	<b>1721212C</b>	25



Pipe, Welding  
& Tube Fittings

Male Unions

NPSM	NPSM	Brass		Pkg Qty
		Previous Part #	Part #	
1/8"	1/8"	176-0202	<b>1760202C</b>	100
1/4"	1/4"	176-0404	<b>1760404C</b>	100
3/8"	3/8"	176-0606	<b>1760606C</b>	100
1/2"	1/2"	176-0808	<b>1760808C</b>	50



• For additional information on pipe dimensions please reference [dixonvalve.com](http://dixonvalve.com).

NPT Threaded 90° Elbows



300# iron



150# iron



150# galvanized iron



150# 316 stainless steel



2000# forged steel



125# brass

Features:

- other sizes are also available
- 304 stainless steel fittings are also available, consult Dixon® for pricing and availability

Female NPT	300# Iron Part #	150# Iron Part #	150# Galvanized Iron Part #
1/8"	---	<b>EL9018</b>	<b>EL9018G</b>
1/4"	<b>300EL9025</b>	<b>EL9025</b>	<b>EL9025G</b>
3/8"	<b>300EL9038</b>	<b>EL9038</b>	<b>EL9038G</b>
1/2"	<b>300EL9050</b>	<b>EL9050</b>	<b>EL9050G</b>
3/4"	<b>300EL9075</b>	<b>EL9075</b>	<b>EL9075G</b>
1"	<b>300EL90100</b>	<b>EL90100</b>	<b>EL90100G</b>
1 1/4"	<b>300EL90125</b>	<b>EL90125</b>	<b>EL90125G</b>
1 1/2"	<b>300EL90150</b>	<b>EL90150</b>	<b>EL90150G</b>
2"	<b>300EL90200</b>	<b>EL90200</b>	<b>EL90200G</b>
2 1/2"	---	<b>EL90250</b>	---
3"	---	<b>EL90300</b>	<b>EL90300G</b>
4"	---	<b>EL90400</b>	<b>EL90400G</b>
5"	---	<b>EL90500</b>	---
6"	---	<b>EL90600</b>	---

Female NPT	150# 316 Stain. Steel Part #	2000# Forged Steel Part #	125# Brass Part #
1/8"	<b>EL9018SS</b>	---	---
1/4"	<b>EL90025SS</b>	<b>EL9025FS</b>	---
3/8"	<b>EL90038SS</b>	<b>EL9038FS</b>	---
1/2"	<b>EL90050SS</b>	<b>EL9050FS</b>	---
3/4"	<b>EL90075SS</b>	<b>EL9075FS</b>	---
1"	<b>EL90100SS</b>	<b>EL90100FS</b>	<b>EL90100B</b>
1 1/4"	<b>EL90125SS</b>	<b>EL90125FS</b>	---
1 1/2"	<b>EL90150SS</b>	<b>EL90150FS</b>	<b>EL90150B</b>
2"	<b>EL90200SS</b>	<b>EL90200FS</b>	<b>EL90200B</b>
3"	<b>EL90300SS</b>	---	---
4"	<b>EL90400SS</b>	---	---

90° Female Pipe Elbows

Feature:

- ref SAE 130238



brass



lead free brass

Female NPTF	Extruded Brass		Optional Qty	Forged Lead Free Brass <sup>1, 2, 3</sup>
	Previous Part #	Part #		Part #
1/8"	EL1F1F	<b>302020C</b>	25	---
1/4"	EL2F2F	<b>302040C</b>	25	<b>302040CLF</b>
3/8"	EL3F3F	<b>302060C</b>	25	<b>302060CLF</b>
1/2"	EL4F4F	<b>302080C</b>	25	<b>302080CLF</b>
3/4"	EL6F6F	<b>302121C</b>	10	<b>302121CLF</b>

<sup>1</sup> lead free brass <=0.25% lead; Alloy CA2745; Alloy C46400

<sup>2</sup> conforms To: Safe Water Drinking Act (SWDA) of Jan. 4, 2014; California AB1953; RoHS Compliant

<sup>3</sup> NPT thread

- For additional information on pipe dimensions please reference dixonvalve.com.

NPT Threaded Reducing Elbows

Feature:

- other sizes are also available, consult Dixon® for pricing and availability

Female NPT	Female NPT	150# Iron Part #
1/4"	1/8"	<b>REL2518</b>
1/2"	1/4"	<b>REL5025</b>
1/2"	3/8"	<b>REL5038</b>
3/4"	1/2"	<b>REL7550</b>
1"	1/2"	<b>REL1050</b>
1"	3/4"	<b>REL1075</b>
1 1/4"	1"	<b>REL1210</b>
1 1/2"	1"	<b>REL1510</b>
1 1/2"	1 1/4"	<b>REL1525</b>
2"	1"	<b>REL2010</b>
2"	1 1/2"	<b>REL2015</b>
2 1/2"	2"	<b>REL2520</b>
3"	2"	<b>REL3020</b>
4"	2"	<b>REL4020</b>
4"	3"	<b>REL4030</b>



Pipe, Welding & Tube Fittings

90° Street Elbows

Feature:

- ref SAE 130239

Female NPTF	Male NPTF	Extruded Brass		Optional Qty	Forged Lead Free Brass <sup>1,2</sup>
		Previous Part #	Part #		Part #
1/8"	1/8"	SE1F1M	<b>3040202C</b>	25	<b>3040202CLF</b>
1/4"	1/8"	SE2F1M	<b>3040402C</b>	25	---
1/4"	1/4"	SE2F2M	<b>3040404C</b>	25	<b>3040404CLF</b>
3/8"	1/4"	SE3F2M	<b>3040604C</b>	25	---
3/8"	3/8"	SE3F3M	<b>3040606C</b>	25	<b>3040606CLF</b>
1/2"	3/8"	SE4F3M	<b>3040806C</b>	25	---
1/2"	1/2"	SE4F4M	<b>3040808C</b>	25	<b>3040808CLF</b>
3/4"	1/2"	SE6F4M	<b>3041208C</b>	25	---
3/4"	3/4"	SE6F6M	<b>3041212C</b>	10	---



brass



lead free brass

<sup>1</sup> lead free brass <=0.25% lead; Alloy CA2745; Alloy C46400

<sup>2</sup> conforms To: Safe Water Drinking Act (SWDA) of Jan. 4, 2014; California AB1953; RoHS Compliant

<sup>3</sup> NPT thread

90° Male Pipe Elbows

Male NPTF	Forged Brass		Optional Qty
	Previous Part #	Part #	
1/8"	169-0202	<b>1690202C</b>	25
1/4"	169-0404	<b>1690404C</b>	25
3/8"	169-0606	<b>1690606C</b>	25
1/2"	169-0808	<b>1690808C</b>	25



- For additional information on pipe dimensions please reference [dixonvalve.com](http://dixonvalve.com).

NPT Threaded 90° Street Elbows



150# iron

Features:

- other sizes are also available
- 304 stainless steel fittings are also available, consult Dixon® for pricing and availability



150# galvanized iron



150# 316 stainless steel

Male NPT	Female NPT	150# Iron Part #	150# Galvanized Iron Part #	150# 316 Stain. Steel Part #
1/8"	1/8"	SE9018	SE9018G	SE9018SS
1/4"	1/4"	SE9025	SE9025G	SE9025SS
3/8"	3/8"	SE9038	SE9038G	SE9038SS
1/2"	1/2"	SE9050	SE9050G	SE9050SS
3/4"	3/4"	SE9075	SE9075G	SE9075SS
1"	1"	SE9010	SE9010G	SE9010SS
1 1/4"	1 1/4"	SE9012	SE9012G	SE9012SS
1 1/2"	1 1/2"	SE9015	SE9015G	SE9015SS
2"	2"	SE9020	SE9020G	SE9020SS
2 1/2"	2 1/2"	SE90250	---	---
3"	3"	SE90300	SE9030G	---
4"	4"	SE90400	---	---
6"	6"	SE90600	---	---



3000# forged steel



125# brass

Male NPT	Female NPT	3000# Forged Steel Part #	125# Brass Part #
1/8"	1/8"	---	---
1/4"	1/4"	SE9025FS	---
3/8"	3/8"	SE9038FS	---
1/2"	1/2"	SE9050FS	---
3/4"	3/4"	SE9075FS	SE9075B
1"	1"	SE9010FS	SE9010B
1 1/4"	1 1/4"	SE9012FS	SE9012B
1 1/2"	1 1/2"	SE9015FS	SE9015B
2"	2"	SE9020FS	SE9020B

• For additional information on pipe dimensions please reference [dixonvalve.com](http://dixonvalve.com).

NPT Threaded 45 Elbows

Female NPT	150# Iron Part #
1/8"	EL4518
1/4"	EL4525
3/8"	EL4538
1/2"	EL4550
3/4"	EL4575
1"	EL45100
1 1/4"	EL45125
1 1/2"	EL45150
2"	EL45200
2 1/2"	EL45250
3"	EL45300
4"	EL45400
5"	EL45500
6"	EL45600



Pipe, Welding & Tube Fittings

Size	150# Iron Part #	150# Galvanized Iron Part #
1/8"	SE4518	---
1/4"	SE4525	SE4525G
3/8"	SE4538	---
1/2"	SE4550	SE4550G
3/4"	SE4575	SE4575G
1"	SE45100	---
1 1/4"	SE45125	SE45125G
1 1/2"	SE45150	SE45150G
2"	SE45200	SE45200G
2 1/2"	SE45250	SE45250G
3"	SE45300	SE45300G
4"	SE45400	SE45400G



150# galvanized iron

Feature:

- ref SAE 130339

Female NPTF	Male NPTF	Extruded Brass		Optional Qty
		Previous Part #	Part #	
1/8"	1/8"	306-0202	3060202C	25
1/4"	1/4"	306-0404	3060404C	25
3/8"	3/8"	306-0606	3060606C	25
1/2"	1/2"	306-0808	3060808C	25
3/4"	3/4"	306-1212	3061212C	10



• For additional information on pipe dimensions please reference [dixonvalve.com](http://dixonvalve.com).

NPT Threaded Female Tees



300# iron



150# iron



150# galvanized iron



150# 316 stainless steel



2000# forged steel



125# brass

Female NPT	300# Iron Part #	150# Iron Part #	150# Galvanized Iron Part #
1/8"	---	<b>FT18</b>	---
1/4"	<b>300FT25</b>	<b>FT25</b>	<b>FT25G</b>
3/8"	<b>300FT38</b>	<b>FT38</b>	<b>FT38G</b>
1/2"	<b>300FT50</b>	<b>FT50</b>	<b>FT50G</b>
3/4"	---	<b>FT75</b>	<b>FT75G</b>
1"	<b>300FT10</b>	<b>FT10</b>	<b>FT100G</b>
1 1/4"	<b>300FT120</b>	<b>FT120</b>	<b>FT120G</b>
1 1/2"	---	<b>FT15</b>	<b>FT150G</b>
2"	<b>300FT200</b>	<b>FT200</b>	<b>FT200G</b>
2 1/2"	---	<b>FT250</b>	---
3"	---	<b>FT30</b>	<b>FT300G</b>
4"	---	<b>FT40</b>	<b>FT400G</b>
5"	---	<b>FT500</b>	---
6"	---	<b>FT60</b>	---

Female NPT	150# 316 Stainless Steel Part #	2000# Forged Steel Part #	125# Brass Part #
1/8"	---	---	---
1/4"	<b>FT25SS</b>	<b>FT25FS</b>	---
3/8"	<b>FT38SS</b>	---	---
1/2"	<b>FT50SS</b>	<b>FT50FS</b>	---
3/4"	<b>FT75SS</b>	<b>FT75FS</b>	<b>FT75B</b>
1"	<b>FT10SS</b>	<b>FT100FS</b>	<b>FT10B</b>
1 1/4"	<b>FT120SS</b>	<b>FT120FS</b>	---
1 1/2"	<b>FT150SS</b>	<b>FT150FS</b>	<b>FT15B</b>
2"	<b>FT200SS</b>	<b>FT200FS</b>	<b>FT20B</b>

Female Tees

Feature:

- ref SAE 130438



brass



lead free brass

NPTF Thread	Extruded Brass		Optional Qty	Forged Lead Free Brass <sup>1,2,3</sup>
	Previous Part #	Part #		Part #
1/8"	322-0202	<b>3220202C</b>	25	<b>3220202CLF</b>
1/4"	322-0404	<b>3220404C</b>	25	<b>3220404CLF</b>
3/8"	322-0606	<b>3220606C</b>	25	<b>3220606CLF</b>
1/2"	322-0808	<b>3220808C</b>	25	<b>3220808CLF</b>
3/4"	322-1212	<b>3221212C</b>	10	<b>3221212CLF</b>

<sup>1</sup> lead free brass <=0.25% lead; Alloy CA2745; Alloy C46400

<sup>2</sup> conforms To: Safe Water Drinking Act (SWDA) of Jan. 4, 2014; California AB1953; RoHS Compliant

<sup>3</sup> NPT thread

- For additional information on pipe dimensions please reference dixonvalve.com.

NPT Threaded Side Outlet Elbows

Female NPT	150# Iron Part #
1/8"	<b>SOE18</b>
1/4"	<b>SOE25</b>
3/8"	<b>SOE38</b>
1/2"	<b>SOE50</b>
3/4"	<b>SOE75</b>
1"	<b>SOE100</b>
1 1/4"	<b>SOE120</b>
1 1/2"	<b>SOE150</b>
2"	<b>SOE200</b>



Pipe, Welding & Tube Fittings

NPT Threaded Female Reducing Tees

Female NPT	Female NPT	150# Iron Part #
3/8"	1/4"	<b>FRT3825</b>
1/2"	3/8"	<b>FRT5038</b>
3/4"	1/2"	<b>FRT7550</b>
1"	1/2"	<b>FRT1050</b>
1 1/4"	1"	<b>FRT1210</b>
1 1/2"	1"	<b>FRT1510</b>
2"	1"	<b>FRT2010</b>
2"	1 1/2"	<b>FRT2015</b>
3"	2"	<b>FRT3020</b>



NPT Threaded Street Service Tees

NPT	150# Iron Part #
1/2"	<b>SST50</b>
3/4"	<b>SST75</b>
1"	<b>SST100</b>
1 1/2"	<b>SST150</b>



NPT Threaded Bull Head Tees

Female NPT	Female NPT	150# Iron Part #
1/2"	3/4"	<b>BHT1575</b>
1/2"	1"	<b>BHT1510</b>
3/4"	1"	<b>BHT7510</b>
1"	1 1/2"	<b>BHT1015</b>
1"	2"	<b>BHT1020</b>
1 1/2"	2"	<b>BHT1520</b>
2"	2 1/2"	<b>BHT2025</b>



K

NPT Threaded Side Outlet Tees

Female NPT	150# Iron Part #
1/2"	<b>SOT50</b>
3/4"	<b>SOT75</b>
1"	<b>SOT100</b>
1 1/4"	<b>SOT120</b>
1 1/2"	<b>SOT150</b>
2"	<b>SOT200</b>



• For additional information on pipe dimensions please reference [dixonvalve.com](http://dixonvalve.com).

Street Tees

Feature:

- ref SAE 130424



Female NPTF	Male NPTF	Extruded Brass		Optional Qty	Lead Free Brass <sup>1, 2, 3</sup> Part #
		Previous Part #	Part #		
1/8"	1/8"	326-0202	<b>3260202C</b>	25	---
1/4"	1/4"	326-0404	<b>3260404C</b>	25	<b>3260404CLF</b>
3/8"	3/8"	326-0606	<b>3260606C</b>	25	---
1/2"	1/2"	326-0808	<b>3260808C</b>	25	---
3/4"	3/4"	326-1212	<b>3261212C</b>	10	---

<sup>1</sup> lead free brass <=0.25% lead; Alloy CA2745; Alloy C46400

<sup>2</sup> conforms To: Safe Water Drinking Act (SWDA) of Jan. 4, 2014; California AB1953; RoHS Compliant

<sup>3</sup> NPT thread

Male Branch Tees

Feature:

- ref SAE 130425



NPTF	Extruded Brass		Optional Qty	Lead Free Brass <sup>1, 2, 3</sup> Part #
	Previous Part #	Part #		
1/8"	324-0202	<b>3240202C</b>	25	---
1/4"	324-0404	<b>3240404C</b>	25	---
3/8"	324-0606	<b>3240606C</b>	25	<b>3240606CLF</b>
1/2"	324-0808	<b>3240808C</b>	25	---
3/4"	324-1212	<b>3241212C</b>	10	---

<sup>1</sup> lead free brass <=0.25% lead; Alloy CA2745; Alloy C46400

<sup>2</sup> conforms To: Safe Water Drinking Act (SWDA) of Jan. 4, 2014; California AB1953; RoHS Compliant

<sup>3</sup> NPT thread

NPT Threaded Crosses



Female NPT	150# Iron Part #
1/8"	<b>MIC18</b>
1/4"	<b>MIC25</b>
3/8"	<b>MIC38</b>
1/2"	<b>MIC50</b>
3/4"	<b>MIC75</b>
1"	<b>MIC100</b>
1 1/4"	<b>MIC125</b>
1 1/2"	<b>MIC150</b>
2"	<b>MIC200</b>
2 1/2"	<b>MIC250</b>
3"	<b>MIC300</b>
4"	<b>MIC400</b>

Pipe Crosses



Female NPTF	Extruded Brass		Optional Qty
	Previous Part #	Part #	
1/8"	228-0202	<b>2280202C</b>	25
1/4"	228-0404	<b>2280404C</b>	25
3/8"	228-0606	<b>2280606C</b>	25
1/2"	228-0808	<b>2280808C</b>	10
3/4"	228-1212	<b>2281212C</b>	10

- For additional information on pipe dimensions please reference [dixonvalve.com](http://dixonvalve.com).



NPT Threaded Caps

Features:

- other sizes are also available
- 304 stainless steel fittings are also available, consult Dixon® for pricing and availability

Female NPT	300# Iron Part #	150# Iron Part #
1/8"	---	<b>MICAP18</b>
1/4"	---	<b>MICAP25</b>
3/8"	---	<b>MICAP38</b>
1/2"	<b>300MICAP50</b>	<b>MICAP50</b>
3/4"	<b>300MICAP75</b>	<b>MICAP75</b>
1"	<b>300MICAP100</b>	<b>MICAP100</b>
1 1/4"	<b>300MICAP125</b>	<b>MICAP120</b>
1 1/2"	<b>300MICAP150</b>	<b>MICAP150</b>
2"	<b>300MICAP200</b>	<b>MICAP200</b>
2 1/2"	---	<b>MICAP250</b>
3"	---	<b>MICAP300</b>
4"	---	<b>MICAP400</b>
5"	---	<b>MICAP500</b>
6"	---	<b>MICAP600</b>

Female NPT	150# Galvanized Iron Part #	150# 316 Stainless Steel Part #
1/8"	---	<b>SSCAP18</b>
1/4"	---	<b>SSCAP25</b>
3/8"	---	<b>SSCAP38</b>
1/2"	<b>MICAP50G</b>	<b>SSCAP50</b>
3/4"	<b>MICAP75G</b>	<b>SSCAP75</b>
1"	---	<b>SSCAP10</b>
1 1/4"	---	<b>SSCAP12</b>
1 1/2"	---	<b>SSCAP15</b>
2"	<b>MICAP200G</b>	<b>SSCAP20</b>



300# iron



150# iron



150# galvanized iron



150# 316 stainless steel

Pipe, Welding  
& Tube Fittings

NPT Pipe Caps

Female NPT	Optional Qty	Lead Free Brass <sup>1, 2, 3</sup> Part #
1/8"	50	<b>2130200CLF</b>
1/4"	100	<b>2130400CLF</b>
3/8"	25	<b>2130600CLF</b>
1/2"	25	<b>2130800CLF</b>
3/4"	25	<b>2131200CLF</b>



<sup>1</sup> lead free per NSF/ANSI 372  
<sup>2</sup> lead free brass <=0.25% lead; Alloy CA2745; Alloy C46400  
<sup>3</sup> conforms To: Safe Water Drinking Act (SWDA) of Jan. 4, 2014; California AB1953; RoHS Compliant

• For additional information on pipe dimensions please reference [dixonvalve.com](http://dixonvalve.com).

NPT Threaded Square Head Plugs

Feature:

- forged steel and brass plugs are solid, all others are cored



150# iron



150# galvanized iron



150# 316 stainless steel



3000# forged steel



125# brass

Male NPT	150# Iron Part #	150# Galvanized Iron Part #	150# 316 Stain. Steel Part #
1/8"	<b>SHP18</b>	<b>SHP18G</b>	<b>SHP18SS</b>
1/4"	<b>SHP14</b>	<b>SHP14G</b>	<b>SHP14SS</b>
3/8"	<b>SHP38</b>	<b>SHP38G</b>	<b>SHP38SS</b>
1/2"	<b>SHP50</b>	<b>SHP50G</b>	<b>SHP50SS</b>
3/4"	<b>SHP75</b>	<b>SHP75G</b>	<b>SHP75SS</b>
1"	<b>SHP100</b>	<b>SHP100G</b>	<b>SHP100SS</b>
1 1/4"	<b>SHP125</b>	<b>SHP125G</b>	<b>SHP125SS</b>
1 1/2"	<b>SHP150</b>	<b>SHP150G</b>	<b>SHP150SS</b>
2"	<b>SHP200</b>	<b>SHP200G</b>	<b>SHP200SS</b>
2 1/2"	<b>SHP250</b>	<b>SHP250G</b>	<b>SHP250SS</b>
3"	<b>SHP300</b>	<b>SHP300G</b>	<b>SHP300SS</b>
4"	<b>SHP400</b>	<b>SHP400G</b>	<b>SHP400SS</b>
5"	<b>SHP500</b>	---	---
6"	<b>SHP600</b>	<b>SHP600G</b>	---

Male NPT	3000# Forged Steel Part #	125# Brass Part #
1/8"	---	<b>2110200C</b> <sup>1,2</sup>
1/4"	<b>SHP14FS</b>	<b>2110400C</b> <sup>1,2</sup>
3/8"	<b>SHP38FS</b>	<b>2110600C</b> <sup>1,2</sup>
1/2"	<b>SHP50FS</b>	<b>2110800C</b> <sup>1,2</sup>
3/4"	<b>SHP75FS</b>	<b>2111200C</b> <sup>1,2</sup>
1"	<b>SHP100FS</b>	<b>SHP100B</b>
1 1/2"	<b>SHP150FS</b>	<b>SHP150B</b>
2"	<b>SHP200FS</b>	---
3"	<b>SHP300FS</b>	---

<sup>1</sup> lead free brass per NSF/ANSI 372, Brass Alloy 260/270

<sup>2</sup> threads are PTF-SAE

Hex Head Plugs

NPT	Brass		Pkg Qty	Lead Free Brass <sup>1,2</sup> Part #
	Previous Part #	Part #		
1/8"	HHP1M	<b>1630200C</b>	50	<b>1630200CLF</b>
1/4"	HHP2M	<b>1630400C</b>	100	<b>1630400CLF</b>
3/8"	HHP3M	<b>1630600C</b>	25	---
1/2"	HHP4M	<b>1630800C</b>	25	---
3/4"	HHP6M	<b>1631200C</b>	25	---
1"	HHP8M	<b>1631600C</b>	10	---



- standard brass hex head plug is hollow; lead free brass is solid

<sup>1</sup> lead free brass <=0.25% lead; Alloy CA2745; Alloy C46400

<sup>2</sup> conforms To: Safe Water Drinking Act (SWDA) of Jan. 4, 2014; California AB1953; RoHS Compliant

Hex Socket Plugs

NPTF	Lead Free Brass <sup>1</sup>		Optional Qty
	Previous Part #	Part #	
1/8"	219-0200	<b>2190200C</b>	50
1/4"	219-0400	<b>2190400C</b>	100
3/8"	219-0600	<b>2190600C</b>	25
1/2"	219-0800	<b>2190800C</b>	25
3/4"	219-1200	<b>2191200C</b>	25



<sup>1</sup> lead free brass per NSF/ANSI 372, Brass Alloy 260/270

- For additional information on pipe dimensions please reference dixonvalve.com.

Polypropylene Schedule 80 - Pipe Couplings

Female NPT	Polypropylene Part #
3/4"	<b>62238</b>
1"	<b>62239</b>
1 1/2"	<b>62241</b>
2"	<b>62194</b>



Pipe, Welding & Tube Fittings

Tuff-Lite™ - Female NPT x Female NPT Adapters

- sold in package quantity only

Female NPT	Female NPT	Nylon Part #	Pkg Qty
1/2"	1/2"	<b>TA994</b>	25
3/4"	3/4"	<b>TA996</b>	25



Polypropylene Schedule 80 - Reducer Bushings

Male NPT	Female NPT	Polypropylene Part #
1/2"	1/4"	<b>62267</b>
3/4"	1/2"	<b>62272</b>
1"	1/2"	<b>62275</b>
1"	3/4"	<b>62276</b>
1 1/4"	3/4"	<b>62277</b>
1 1/4"	1"	<b>62278</b>
1 1/2"	3/4"	<b>62279</b>
1 1/2"	1"	<b>62280</b>
1 1/2"	1 1/4"	<b>62281</b>
2"	3/4"	<b>62195</b>
2"	1"	<b>62196</b>
2"	1 1/4"	<b>62197</b>
2"	1 1/2"	<b>62198</b>
3"	2"	<b>60330</b>



Tuff-Lite™ - Male NPT x Female Threaded Swivel Nut Adapters

- female shipped with a red vinyl washer (**TVW7**), replacement washers on page 242

Male NPT	Female Thread	Nylon Part #
1/4"	3/4" GHT	<b>TSA72</b>
3/8"	3/4" GHT	<b>TSA73</b>
1/4"	3/4" NPS	<b>TSA62</b>
3/8"	3/4" NPS	<b>TSA63</b>



Tuff-Lite™ - Reducing Bushings

Male NPT	Female NPT	Nylon Part #
3/8"	1/4"	<b>THB32</b>
1/2"	1/4"	<b>THB42</b>
1/2"	3/8"	<b>THB43</b>
3/4"	1/2"	<b>THB64</b>
1"	3/4"	<b>THB86</b>



- For additional information on pipe dimensions please reference [dixonvalve.com](http://dixonvalve.com).

Tuff-Lite™ - Close Nipples

- sold in package quantity only



Male NPT	Nylon Part #	Pkg Qty
1/4"	<b>TCN202</b>	50
3/8"	<b>TCN303</b>	50
1/2"	<b>TCN404</b>	50
3/4"	<b>TCN606</b>	50

Polypropylene Schedule 80 - Hex Nipples

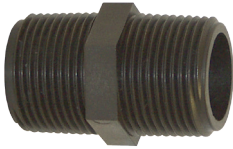

Male NPT	Polypropylene Part #
1/2"	<b>62221</b>
3/4"	<b>60554</b>
1"	<b>60555</b>
1 1/4"	<b>60556</b>
1 1/2"	<b>60547</b>
2"	<b>60548</b>
3"	<b>61769</b>

Polypropylene Schedule 80 - Reducer Nipples



Male NPT	Male NPT	Polypropylene Part #
3/4"	1/2"	<b>62233</b>
1"	3/4"	<b>62234</b>
1 1/4"	1"	<b>62235</b>
1 1/2"	1 1/4"	<b>62236</b>
2"	1 1/2"	<b>60549</b>

Polypropylene Schedule 80 - Nipples



Male NPT	Length	Polypropylene Part #
3/4"	4"	<b>62223</b>
3/4"	6"	<b>62224</b>
1"	4"	<b>62225</b>
1"	6"	<b>62226</b>
2"	4"	<b>62192</b>
2"	6"	<b>62193</b>

- For additional information on pipe dimensions please reference [dixonvalve.com](http://dixonvalve.com).

Polypropylene Schedule 80 - 90° Elbows

Female NPT	Polypropylene Part #
1/2"	<b>62215</b>
3/4"	<b>62216</b>
1"	<b>62217</b>
1 1/2"	<b>62219</b>
2"	<b>62191</b>
3"	<b>62220</b>



Pipe, Welding & Tube Fittings

Tuff-Lite™ - Street Female NPT x 90° Male NPT Elbows

Female NPT	Male NPT	Nylon Part #
1/4"	1/4"	<b>TSE22</b>
1/2"	1/2"	<b>TSE44</b>
3/4"	3/4"	<b>TSE66</b>



Polypropylene Schedule 80 - 90° Street Elbows

NPT Thread	Polypropylene Part #
1/2"	<b>62243</b>
3/4"	<b>62244</b>
1"	<b>62245</b>
1 1/4"	<b>62246</b>
1 1/2"	<b>62247</b>
2"	<b>62199</b>
3"	<b>62248</b>



Polypropylene Schedule 80 - Tees

Female NPT	Polypropylene Part #
1/2"	<b>62209</b>
3/4"	<b>62210</b>
1"	<b>62211</b>
1 1/4"	<b>62212</b>
1 1/2"	<b>62213</b>
2"	<b>62190</b>
3"	<b>62214</b>



Polypropylene Schedule 80 - Cross

Female NPT	Polypropylene Part #
1"	<b>62263</b>



• For additional information on pipe dimensions please reference [dixonvalve.com](http://dixonvalve.com).

Tuff-Lite™ - Female Threaded Swivel Nuts



Female Thread	Nylon Part #
3/4" NPSM	<b>TCF6</b>
3/4" GHT	<b>TCF7</b>

Tuff-Lite™ - Threaded Caps

- sold in package quantity only



Female Thread	Nylon Part #	Pkg Qty
1/4" NPT	<b>TTC2</b>	50
3/8" NPT	<b>TTC3</b>	50
1/2" NPT	<b>TTC4</b>	50
3/4" NPT	<b>TTC6</b>	50
3/4" GHT	<b>TTC7</b>	50

Tuff-Lite™ - Hex Head Drain Plugs

- sold in package quantity only



Male NPT	Nylon Part #	Pkg Qty
1/8"	<b>TPX1</b>	50
1/4"	<b>TPX2</b>	50
3/8"	<b>TPX3</b>	50
1/2"	<b>TPX4</b>	50
3/4"	<b>TPX6</b>	50
1"	<b>TPX8</b>	50
1 1/4"	<b>TPX10</b>	25

Tuff-Lite™ - Square Head Drain Plugs

- sold in package quantity only



Male NPT	Nylon Part #	Pkg Qty
1/8"	<b>TPS1</b>	50
1/4"	<b>TPS2</b>	50
3/8"	<b>TPS3</b>	50
1/2"	<b>TPS4</b>	50
3/4"	<b>TPS6</b>	50
1"	<b>TPS8</b>	50
1 1/4"	<b>TPS10</b>	25

Polypropylene Schedule 80 - Pipe Caps



Female NPT	Polypropylene Part #
3/4"	<b>62250</b>
1"	<b>62251</b>

Polypropylene Schedule 80 - Pipe Plugs



Male NPT	Polypropylene Part #
3/4"	<b>62256</b>
1"	<b>62257</b>
1 1/4"	<b>62258</b>
1 1/2"	<b>62259</b>
2"	<b>62201</b>

- For additional information on pipe dimensions please reference [dixonvalve.com](http://dixonvalve.com).

Bulkhead Fittings

**Application:**

- for use on most poly storage tanks and many steel and fiberglass tanks

**Features:**

- glass reinforced polypropylene provides strength and chemical resistance
- EPDM gaskets are standard
- FKM gaskets are available, contact Dixon® to order

**female NPT fittings**

Female NPT	Hole Size	Polypropylene Part #
1/2"	1-7/16"	<b>62834</b>
3/4"	1-7/16"	<b>60401</b>
1"	2-1/4"	<b>60427</b>
1 1/4"	2-1/4"	<b>60403</b>
1 1/2"	3"	<b>60124</b> <b>NEW</b>
1 1/2"	2-3/8"	<b>63931</b> <sup>1</sup>
2"	3"	<b>60405</b>
2"	3"	<b>63481</b> <sup>2</sup>
2" HD <sup>3</sup>	3-1/4"	<b>63683</b>
3"	4-1/2"	<b>62299</b> <sup>1</sup>



Pipe, Welding & Tube Fittings

<sup>1</sup> 1 1/2" and 3" do not contain a washer

<sup>2</sup> designed for tank wall thickness less than 3/8" - low profile

**Gaskets**

Size	EPDM Part #
1/2" - 3/4"	<b>60402</b>
1" - 1 1/4"	<b>60404</b>
1 1/2"	<b>63938</b>
2"	<b>60406</b>
2" HD <sup>1</sup>	<b>60336</b>
3"	<b>60331</b>



<sup>1</sup> heavy duty

Bulkhead Couplings

Female NPTF	External Male UNS	Length	Brass Part #
1/8"	5/8"	1.50"	<b>207BH2</b>
1/4"	3/4"	1.50"	<b>207BH4</b>
1/4"	3/4"	.94"	<b>207BH4S</b>
3/8"	1"	1.31"	<b>207BH6</b>
1/2"	1-1/8"	1.50"	<b>207BH8</b>
3/4"	1-5/16"	1.50"	<b>207BH12</b>



K

Note: washer nut is 12L14 steel

## Bolted Fittings

## Polypropylene Female NPT fittings

## Features:

- bolts thread into back plate of fitting leaving no welds, holes as potential points of leakage
- 316 stainless steel bolts
- 2 required, EPDM gaskets are standard (sold separately)
- FKM gaskets are available, contact Dixon®



Size	Polypropylene Part #
¾"	<b>60502</b>
1"	<b>60505</b>
1½"	<b>60513</b>
2"	<b>60516</b>

## Gaskets

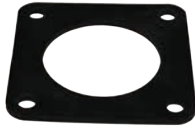

Size	EPDM Part #
¾" - 1"	<b>60498</b>
1½" - 2"	<b>60497</b>

## Stainless Steel Female NPT fittings

## Features:

- bolts thread into back plate of fitting leaving no welds, holes as potential points of leakage
- 316 stainless steel bolts
- required, cross-linked polyethylene gaskets are standard (*sold separately*)
- FKM and EPDM gaskets are available, contact Dixon®



Size	Stainless Steel Part #
¾"	<b>63035</b>
1"	<b>62948</b>
1½"	<b>63037</b>
2"	<b>63038</b>

## Gaskets

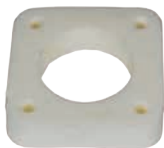

Size	Cross-Linked Polyethylene Part #
¾" - 1"	<b>62950</b>
1½"	<b>63042</b>
2"	<b>62848</b>



Swage Nipples

Features:

- manufactured in conformance with ASTM A234 and MSS SP-95
- threads on nipples conform to ASME B1.20.1
- schedule 40 nipples have blue caps
- schedule 80 nipples have green caps

Male NPT	Length	Zinc Plated Schedule 40 Part #
2" x 1"	6.5"	SW40-200100
2" x 1¼"	6.5"	SW40-200125
2" x 1½"	6.5"	SW40-200150
2½" x 1"	7"	SW40-250100
2½" x 1½"	7"	SW40-250150
2½" x 2"	7"	SW40-250200
3" x 2"	8"	SW40-300200
3" x 2½"	8"	SW40-300250
4" x 2"	9"	SW40-400200
4" x 2½"	9"	SW40-400250
4" x 3"	9"	SW40-400300
6" x 3"	12"	SW40-600300
6" x 4"	12"	SW40-600400
8" x 4"	13"	SW40-800400
8" x 6"	13"	SW40-800600



Pipe, Welding  
& Tube Fittings

Male NPT	Length	Zinc Plated Schedule 80 Part #
½" x ¼"	2.8"	SW80-050025
½" x ⅜"	2.8"	SW80-050038
¾" x ½"	3.0"	SW80-075050
1" x ¼"	3.5"	SW80-100025
1" x ½"	3.5"	SW80-100050
1" x ¾"	3.5"	SW80-100075
2" x ½"	6.5"	SW80-200050
2" x ¾"	6.5"	SW80-200075
2" x 1"	6.5"	SW80-200100
2" x 1¼"	6.5"	SW80-200125
2" x 1½"	6.5"	SW80-200150
2½" x 2"	7.0"	SW80-250200
3" x 1"	8.0"	SW80-300100
3" x 2"	8.0"	SW80-300200
3" x 2½"	8.0"	SW80-300250
4" x 2"	9.0"	SW80-400200
4" x 3"	9.0"	SW80-400300
4" x 4"	9.0"	SW80-400400
6" x 3"	12.0"	SW80-600300
6" x 4"	12.0"	SW80-600400
8" x 6"	13.0"	SW80-800600



K

• For additional information on pipe dimensions please reference [dixonvalve.com](http://dixonvalve.com).

## Bull Plugs



schedule 80

**Features:**

- manufactured in conformance with ASTM A234 and MSS SP-95
- threads on nipples conform to ASME B1.20.1
- schedule 40 nipples have blue caps
- schedule 80 nipples have green caps

Male NPT	Length	Zinc Plated Schedule 40 Part #	Zinc Plated Schedule 80 Part #
2"	4"	<b>BP40-200</b>	<b>BP80-200</b>
2½"	5"	<b>BP40-250</b>	<b>BP80-250</b>
3"	6"	<b>BP40-300</b>	<b>BP80-300</b>
4"	7"	<b>BP40-400</b>	<b>BP80-400</b>

## Bull Plugs with Tap



schedule 40

**Features:**

- manufactured in conformance with ASTM A234 and MSS SP-95
- threads on nipples conform to ASME B1.20.1
- schedule 40 nipples have blue caps
- schedule 80 nipples have green caps

Male NPT	Length	Zinc Plated Schedule 40 Part #	Zinc Plated Schedule 80 Part #
2" x ¼"	4"	<b>BP40-200T025</b>	<b>BP80-200T025</b>
2" x ½"	5"	<b>BP40-200T050</b>	<b>BP80-200T050</b>
3" x ½"	6"	<b>BP40-300T050</b>	<b>BP80-300T050</b>
4" x ½"	7"	<b>BP40-400T050</b>	<b>BP80-400T050</b>

- For additional information on pipe dimensions please reference [dixonvalve.com](http://dixonvalve.com).

Hammer Unions

Features:

- Socket weld configurations and other materials are available, contact Dixon® for further information.
- Hammer unions work at extremely high pressures. Mismatching components of one series with another (i.e. series 602 with series 1502) can lead to destruction of property, serious bodily injury or death.
- temperature range: **-20°F to 250°F (-29°C to 121°C)**
- non-shocking cold water pressure means that the rated value is the maximum operating pressure at ambient temperature
- no spikes higher than this pressure
- no instantaneous pressure increases (0-2000 PSIG in ¼ of a second)
- ambient temperature: **70°F (21°C)**



100 Series

Features:

- used on low pressure manifolds and lines and in applications running air, water, oil or gas up to **1,000 PSI NSCWP** (non-shock cold working pressure)
- yellow sub, black nut

Size	Configuration	NSCWP (PSI)	Forged Steel Part #
2"	threaded	1000	HU100200
	butt weld	1000	HU100200BW <sup>1</sup>
2½"	threaded	1000	HU100250
3"	threaded	1000	HU100300
4"	threaded	1000	HU100400
	butt weld	1000	HU100400BW <sup>1</sup>
6"	threaded	1000	HU100600
8"	threaded	1000	HU100800

<sup>1</sup> butt weld ends are schedule 40



200 Series

Features:

- used in general service applications running air, water, oil or gas up to **2,000 PSI NSCWP** (non-shock cold working pressure)
- Nitrile O-ring mounted sub provides excellent sealing properties
- grey sub, blue nut

Size	Configuration	NSCWP (PSI)	Forged Steel Part #
1"	threaded	2000	HU200100
1½"	threaded	2000	HU200150
2"	threaded	2000	HU200200
	butt weld	2000	HU200200BW <sup>1</sup>
2½"	threaded	2000	HU200250
3"	threaded	2000	HU200300
4"	threaded	2000	HU200400
6"	threaded	2000	HU200600
8"	threaded	2000	HU200800

<sup>1</sup> butt weld ends are schedule 40



206 Series

Features:

- used in general service applications running air, water, oil and gas up to **2,000 PSI NSCWP** (non-shock cold working pressure)
- Nitrile O-ring mounted sub provides excellent sealing properties
- grey sub, blue nut

Size	Configuration	NSCWP (PSI)	Forged Steel Part #
1"	threaded	2000	HU206100
1½"	threaded	2000	HU206150
2"	threaded	2000	HU206200
2½"	threaded	2000	HU206250
3"	threaded	2000	HU206300
4"	threaded	2000	HU206400
6"	threaded	2000	HU206600
8"	threaded	2000	HU206800



## Hammer Unions

## 400 Series

## Features:

- used on manifold and line connections, pump, suction and mud service
- up to **4,000 PSI NSCWP** (non-shock cold working pressure)
- red sub, black nut



Size	Configuration	NSCWP (PSI)	Forged Steel Part #
2"	threaded	<b>4000</b>	<b>HU400200</b>
3"	threaded	<b>4000</b>	<b>HU400300</b>
4"	threaded	<b>4000</b>	<b>HU400400</b>

## 602 Series

## Features:

- for use in mud, manifold service and truck mounting applications running water, oil or mud up to **6,000 PSI NSCWP** (non-shock cold working pressure)
- lip type seal ring minimizes fluid flow turbulence while creating a pressure seal
- orange sub, black nut



Size	Configuration	NSCWP (PSI)	Forged Steel Part #
1"	threaded	<b>6000</b>	<b>HU602100</b>
2"	threaded	<b>6000</b>	<b>HU602200</b>
	butt weld	<b>6000</b>	<b>HU602200BW<sup>1</sup></b>
3"	threaded	<b>6000</b>	<b>HU602300</b>
	butt weld	<b>6000</b>	<b>HU602300BW<sup>1</sup></b>
4"	threaded	<b>6000</b>	<b>HU602400</b>
	butt weld	<b>6000</b>	<b>HU602400BW<sup>1</sup></b>

<sup>1</sup> butt weld ends are schedule 80

## 1002 Series

## Features:

- for use in high pressure systems and truck mounting applications running water, oil or mud up to **10,000 PSI NSCWP** (non-shock cold working pressure)
- lip type seal ring minimizes fluid flow turbulence while creating a pressure seal
- blue sub, red nut



Size	Configuration	NSCWP (PSI)	Forged Steel Part #
1"	threaded	<b>10000</b>	<b>HU1002100</b>
2"	threaded	<b>10000</b>	<b>HU1002200</b>
	butt weld	<b>10000</b>	<b>HU1002200BW<sup>1</sup></b>
3"	threaded	<b>10000</b>	<b>HU1002300</b>
	butt weld	<b>10000</b>	<b>HU1002300BW<sup>1</sup></b>
4"	threaded	<b>10000</b>	<b>HU1002400</b>
	butt weld	<b>10000</b>	<b>HU1002400BW<sup>1</sup></b>

<sup>1</sup> butt weld ends are schedule XXS

Hammer Unions

1502 Series

Features:

- for use in extreme high pressure applications running water, oil or mud up to **15,000 PSI** NSCWP (non-shock cold working pressure)
- lip type seal ring minimizes fluid flow turbulence while creating a pressure seal
- red sub, blue nut

Size	Configuration	NSCWP (PSI)	Forged Steel Part #
2"	threaded	<b>15000</b>	<b>HU1502200</b>
	butt weld	<b>15000</b>	<b>HU1502200BW<sup>1</sup></b>
3"	threaded	<b>15000</b>	<b>HU1502300</b>
	butt weld	<b>15000</b>	<b>HU1502300BW<sup>1</sup></b>
4"	threaded	<b>15000</b>	<b>HU1502400</b>
	butt weld	<b>15000</b>	<b>HU1502400BW<sup>1</sup></b>

<sup>1</sup> butt weld ends are schedule XXS



Pipe, Welding & Tube Fittings

Hookie - Hook Hose Lifter

Features:

- for use with hammer unions on pages 681, 683
- safe working load is 4 tons, with a proof load test of 8 tons
- supplied complete with retaining clamp

Size	Forged Steel Part #
3"	<b>HA0900-3</b>
4"	<b>HA0900-4</b>
5"	<b>HA0900-5</b>



NPT Threaded Pipe Fittings



Size	Overall Length	Carbon Steel Part #	304 Stainless Steel Part #	Aluminum Part #
1/4"	2"	<b>PN250</b>	<b>PNS250</b>	---
3/8"	2"	<b>PN375</b>	<b>PNS375</b>	---
1/2"	2"	<b>PN500</b>	<b>PNS500</b>	---
3/4"	2"	<b>PN750</b>	<b>PNS750</b>	---
1"	2"	<b>PN1000</b>	<b>PNS1000</b>	---
1 1/4"	2"	<b>PN1250</b>	<b>PNS1250</b>	---
1 1/2"	2"	<b>PN1500</b>	<b>PNS1500</b>	---
2"	2"	<b>PN2000</b>	<b>PNS2000</b>	---
2 1/2"	3"	<b>PN2500</b>	<b>PNS2500</b>	---
3"	3"	<b>PN3000</b>	<b>PNS3000</b>	<b>APN3000</b>
4"	4"	<b>PN4000</b>	<b>PNS4000</b>	<b>APN4000</b>

Dixon® Hex Nipples for Welding to Metal Hose



carbon steel

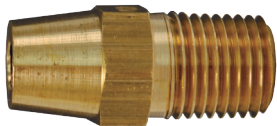

machined brass



global stainless

Size	Carbon Steel <sup>1</sup> Part #	Optional Qty	Machined Brass Part #
1/4"	<b>FM250</b>	200	<b>FMB250</b>
3/8"	<b>FM375</b>	100	<b>FMB375</b>
1/2"	<b>FM500</b>	50	<b>FMB500</b>
3/4"	<b>FM750</b>	50	<b>FMB750</b>
1"	<b>FM1000</b>	50	<b>FMB1000</b>
1 1/4"	<b>FM1250</b>	50	---
1 1/2"	<b>FM1500</b>	50	---
2"	<b>FM2000</b>	10	---

Size	304 Stainless Steel <sup>1</sup> Part #	Optional Qty	316 Stainless Steel <sup>1</sup> Part #
1/4"	<b>FMS250</b>	200	---
3/8"	<b>FMS375</b>	100	---
1/2"	<b>FMS500<sup>2</sup></b>	50	<b>FMR500<sup>2</sup></b>
3/4"	<b>FMS750<sup>2</sup></b>	50	<b>FMR750<sup>2</sup></b>
1"	<b>FMS1000<sup>2</sup></b>	50	<b>FMR1000<sup>2</sup></b>
1 1/4"	<b>FMS1250</b>	50	---
1 1/2"	<b>FMS1500</b>	50	<b>FMR1500</b>

<sup>1</sup> Dixon® suggests using 308 LSI welding rod

<sup>2</sup> global stainless steel

Dixon® Octagonal Nipples for Welding to Metal Hose



Size	Overall Length	Weld-On Length	Hex Length	Carbon Steel Part #	304 Stainless Steel Part #
2"	2 1/2"	7/8"	9/16"	<b>OCTOE32</b>	<b>OCTOES32</b>

• For additional information on pipe dimensions please reference [dixonvalve.com](http://dixonvalve.com).

Dixon® Octagonal Wrench Grips

Size	Across Outside Flats	Across Inside Flats	Width	304 Stainless Steel Part #
1½"	2.230"	1.910"	9/16"	<b>OCTS24</b>
2"	2.781"	2.385"	9/16"	<b>OCTS32</b>
3"	3.750"	3.510"	7/8"	<b>OCTS48</b>

Size	Across Outside Flats	Across Inside Flats	Width	304 Stainless Steel Part #
2"	2.740"	2.510"	9/16"	<b>OCT32</b>



Pipe, Welding  
& Tube Fittings

Dixon® Weld-On Hex Wrench Grips

Size	Global Investment Cast Steel Part #
1"	<b>WN12</b>
1¼"	<b>WN16</b>
1½"	<b>WN21</b>
2"	<b>WN26</b>
2½"	<b>WN31</b>
3"	<b>WN36</b>
4"	<b>WN46</b>



## Straub Grip-L Axial Restraint Pipe Couplings

**Application:**

- suitable for pipes within the lower pressure range, applications include, but are not limited to: ship building, water and waste water treatment plants and industrial process pipe work

**Features:**

- joins like or dissimilar pipe materials: steel, galvanized, painted, stainless steel, thin-wall stainless steel, PVC, copper
- requires no special tools or pipe-end preparation; only a torque wrench is required for a secure and safe pipe connection that seldom needs retightening
- accommodates up to 5° of pipe misalignment
- vary gap between pipe ends
- absorbs vibration, water hammer and sound
- special patented grip ring for superior holding power on hard-surfaced pipes
- 5 year limited warranty
- reusable
- EPDM sealing sleeve temperature range: - 4°F to 176°F (-20°C to 80°C)
- NBR and FKM sleeves available, contact Dixon® for information

**Materials:**

- casing: AISI 316Ti; screws: AISI 316 L; bolts: AISI 316 Ti; anchoring ring: AISI 301; sealing sleeve: EPDM standard

**Specifications:**

- American Bureau of Shipping (ABS) up to **232 PSI** on ¾" - 5"; **188 PSI** on 6"; **145 PSI** on 8"
- Underwriter's Laboratories (UL)
- National Sanitation Foundation (NSF)
- built to ASTM 1476, Type 2, Class 2 specifications

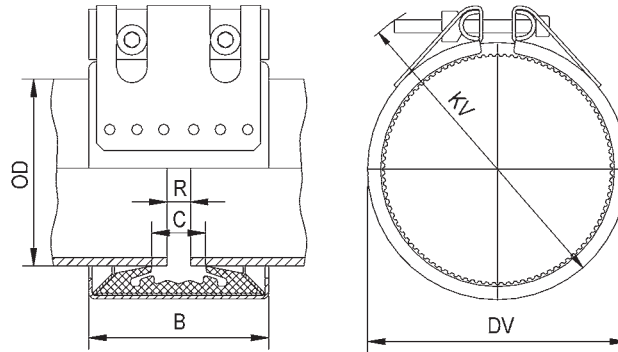

Size	Pipe OD Range		Working Pressure PSI	Coupling Dimensions		Assembled Dimensions		Maximum Distance Between Pipe End R	316 Ti Stainless Steel Part #
	actual	min to max		B	C	DV	KV		
¾"	1.05"	1.04" to 1.08"	<b>670</b>	1.8"	0.7"	1.7"	2.8"	0.2"	<b>STR20000</b> <sup>1</sup>
1"	1.31"	1.31" to 1.35"	<b>550</b>	1.8"	0.7"	2.0"	3.0"	0.2"	<b>STR20100</b> <sup>1</sup>
1½"	1.90"	1.88" to 1.92"	<b>440</b>	2.4"	1.0"	2.6"	3.9"	0.2"	<b>STR20300</b> <sup>1</sup>
2"	2.37"	2.35" to 2.40"	<b>320</b>	3.0"	1.5"	3.1"	4.3"	0.4"	<b>STR20450</b> <sup>1</sup>
2½"	2.87"	2.85" to 2.90"	<b>450</b>	3.7"	1.6"	3.9"	5.3"	0.4"	<b>STR20500</b>
3"	3.50"	3.46" to 3.54"	<b>320</b>	3.7"	1.6"	4.4"	5.9"	0.4"	<b>STR20650</b>
4"	4.50"	4.46" to 4.54"	<b>232</b>	3.7"	1.6"	5.4"	6.7"	0.4"	<b>STR20900</b>
5"	5.50"	5.51" to 5.62"	<b>232</b>	4.3"	2.1"	6.5"	8.3"	0.4"	<b>STR21150</b>
6"	6.63"	6.56" to 6.69"	<b>232</b>	4.3"	2.1"	7.6"	9.1"	0.4"	<b>STR21350</b>
8"	8.63"	8.54" to 8.71"	<b>232</b>	5.6"	3.1"	9.8"	11.6"	0.4"	<b>STR21400</b>

<sup>1</sup> only has one bolt

Note: All Straub couplings require the correct use of a torque wrench for a safe and proper installation. Straub couplings must be torqued to the specified value as printed on each individual coupling. Failure to do so can result in serious injury or death.

**Not for steam or refrigerant service.**





## Straub Open-Flex 1L Couplings

**Applications:**

- suitable for repairing or joining pipes where access to the pipe end is difficult or impossible

**Features:**

- use to replace bolted sleeve type couplings (AWWA Std. C-219) or for permanent repairs or installation
- wrap-around design differs from similar type repair products because the installation or repair is permanent due to the unique flexible lip seal gasket design
- joins like or dissimilar pipe materials: steel, galvanized, painted, stainless steel, thin-wall stainless steel, PVC, copper
- requires no special tools or pipe-end preparation; only a torque wrench is required for a secure and safe pipe connection that seldom needs retightening
- accommodates up to 5° of pipe misalignment
- vary gap between pipe ends
- absorbs vibration, water hammer, and sound
- acts as an expansion joint; will accept up to .25" of axial movement
- EPDM sealing sleeve temperature range: - 4°F to 176°F (-20°C to 80°C)
- 5 year limited warranty
- reusable

**Materials:**

- casing: AISI 316Ti; screws: AISI 4135 steel; bolts: AISI 12L 14 galvanized

**Specifications:**

- American Bureau of Shipping (ABS) up to 232 PSI
- Underwriter's Laboratories (UL)
- National Sanitation Foundation (NSF)
- conforms to ASTM 1476, Type 2, Class 3 specifications

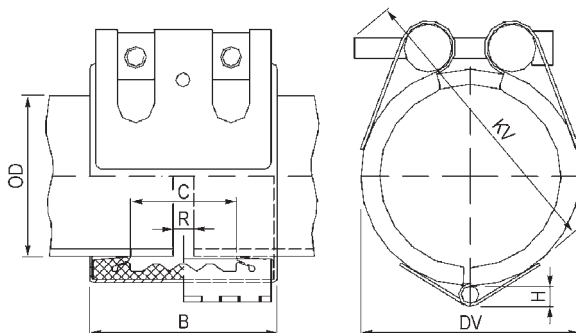

Size	Pipe OD Range		Working Pressure PSI	Coupling Dimensions			Assembled Dimensions		Maximum Distance Between Pipe End R	316 Ti Stainless Steel Part #
	actual	min to max		B	C	H	DV	KV		
1½"	1.90"	1.85" to 1.95"	363	3.0"	1.4"	.28"	2.8"	3.3"	.20"	<b>STR35001</b>
2"	2.38"	2.32" to 2.42"	232	3.0"	1.4"	.28"	3.2"	3.7"	.20"	<b>STR35151</b>
2½"	2.88"	2.81" to 2.93"	232	3.0"	1.4"	.36"	3.2"	3.7"	.20"	<b>STR35201</b>
3"	3.50"	3.44" to 3.56"	232	3.7"	2.0"	.36"	4.4"	4.9"	.20"	<b>STR35351</b>
4"	4.50"	4.43" to 4.57"	232	3.7"	2.0"	.36"	5.4"	5.9"	.20"	<b>STR35651</b>
5"	5.56"	5.49" to 5.57"	232	4.2"	2.4"	.38"	6.4"	7.1"	.20"	<b>STR35901</b>
6"	6.63"	6.54" to 6.71"	232	4.2"	2.4"	.38"	7.5"	8.1"	.20"	<b>STR36051</b>

**⚠ Note: Not pull-out resistant.** Ensure that pipes are properly anchored and supported.

**Assembly Tool**

Part #  
**STR6648**



150 Lb. ASA Forged Lap Joint Flanges

Features:

- no raised face
- commonly called a Van Stone or a floating flange

Pipe, Welding & Tube Fittings



Size	Number of Bolts	Carbon Steel Part #	316 Stainless Steel Part #
1"	4	LJ100	---
1¼"	4	LJ125	---
1½"	4	LJ150	LJR150
2"	4	LJ200	LJR200
2½"	4	LJ250	---
3"	4	LJ300	LJR300
4"	8	LJ400	LJR400
5"	8	LJ500	---
6"	8	LJ600	LJR600
8"	8	LJ800	---
10"	12	LJ1000	---
12"	12	LJ1200	---

150 Lb. ASA Forged Slip-On Flanges

Feature:

- raised face



Size	Number of Bolts	Carbon Steel Part #	316 Stainless Steel Part #
1"	4	SO100	---
1¼"	4	SO125	---
1½"	4	SO150	SOR150
2"	4	SO200	SOR200
2½"	4	SO250	---
3"	4	SO300	SOR300
4"	8	SO400	SOR400
5"	8	SO500	---
6"	8	SO600	SOR600
8"	8	SO800	---
10"	12	SO1000	---
12"	12	SO1200	---

150 Lb. ASA Forged NPT Threaded Flanges

Feature:

- raised face



Size	Number of Bolts	Carbon Steel Part #	316 Stainless Steel Part #
1"	4	T100	---
1¼"	4	T125	---
1½"	4	T150	TR150
2"	4	T200	TR200
2½"	4	T250	---
3"	4	T300	TR300
4"	8	T400	TR400
5"	8	T500	---
6"	8	T600	TR600
8"	8	T800	---
10"	12	T1000	---
12"	12	T1200	---

- For flange dimensions, diagrams and additional information please reference [dixonvalve.com](http://dixonvalve.com).

150 Lb. Weld Neck ASA Forged Flanges

Feature:

- raised face

Size	Number of Bolts	Carbon Steel Part #
1"	4	WN100
1¼"	4	WN125
1½"	4	WN150
2"	4	WN200
3"	4	WN300
4"	8	WN400
5"	8	WN500
6"	8	WN600
8"	8	WN800
10"	12	WN1000

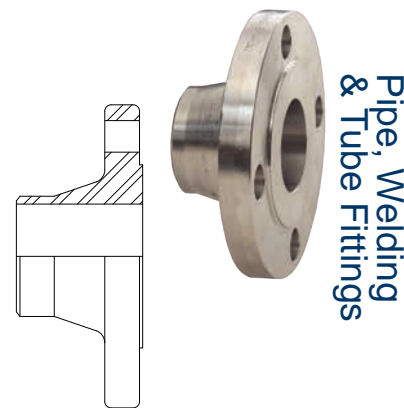

Pipe, Welding & Tube Fittings

Flange Gaskets

Features:

- standard drop-ring type all 1/16" thick
- reference page 903 for joint sealant gasket material
- for flange dimensional information and diagrams please reference dixonvalve.com

Size	Neoprene Part #	Klingersil® C-4401 Part #
1"	NG10	AG10
1¼"	NG15	AG15
1½"	NG20	AG20
2"	NG25	AG25
2½"	NG30	AG30
3"	NG35	AG35
4"	NG40	AG40
5"	NG50	---
6"	NG60	AG60
8"	NG80	AG80



carbon steel



Klingersil® C-4401

ANSI Flat Face Flange x Male NST (NH)

Features:

- flange - black powder coated carbon steel
- male adapter - black anodized aluminum

Size	PSI	Carbon Steel / Aluminum Part #
6" NST (NH)	175	T600-60F



King™ Turned Back Weld-To-Metal Hose Nipples

Features:

- MSS Length
- phono-finish face (type CS), except 10" and 12" have smooth face (type C)
- for use with Slip-On and Lap Joint flanges shown on previous page

Size	Length	Schedule 40 Plated Carbon Steel Part #	Schedule 40 316 Stainless Steel Part #
1"	2"	NW10	RNW10-40
1¼"	2"	NW15	RNW15-40
1½"	2"	NW20	RNW20-40
2"	2½"	NW25	RNW25-40
2½"	2½"	NW30	RNW30-40
3"	2½"	NW35	RNW35-40
4"	3"	NW40	RNW40-40
6"	3½"	NW60	RNW60-40
8"	4"	NW80	RNW80-40
10"	5"	NW100	RNW100-40
12"	6"	NW120	RNW120-40



Quick Release Couplings - Series Q

Features:

- designed for applications requiring a quick connection and/or disconnection of a pipe joint, a locking pin through the handle prevents accidental opening of the coupling
- ductile iron body with zinc plating and steel safety clip
- see page 695 for replacement gaskets
- Comparable to: Victaulic's #78 Grinnell's #7003



Nominal Size	Pipe OD	Maximum Working Pressure PSI at 70°F (21°C)	Maximum End Load (Lbs.)	Ductile Iron	
				Part # with EPDM gasket	Part # with Buna-N gasket
1½"	1.900"	300	850	H315	H315BU
2"	2.375"	300	1329	H32	H32BU
2½"	2.875"	300	2120	H325	H325BU
3"	3.500"	300	2886	H33	H33BU
4"	4.500"	300	4771	H34	H34BU
6"	6.625"	300	10341	H36	H36BU

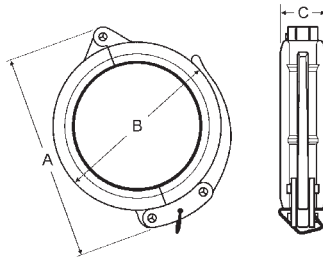

Dimensions

A	B	C
4¾"	3½"	1"
5½"	3¾"	1⅞"
5⅞"	4¾"	1⅞"
7¼"	5¼"	1⅞"
8½"	6½"	2"
10⅝"	8½"	2"

## Standard Couplings - Series S, Style 11

**Applications:**

- designed for a wide range of applications including commercial/industrial construction, mining, and process piping

**Features:**

- ductile iron body with rust inhibiting paint
- Underwriters Listed and Factory Mutual approved
- housing design allows for optimum strength without excessive casting weight.
- see pages 695, 701 for replacement gaskets, nuts and bolts
- Comparable to:
  - Victaulic's #77
  - Grinnell's #7001

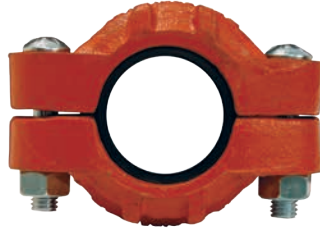

Nominal Size	Pipe OD	Maximum Working Pressure PSI at 70°F (21°C)	Maximum End Load (Lbs.)	Bolts			Ductile Iron	
				qty	size	length	Part # with EPDM gasket	Part # with Buna-N gasket
1½"	1.900"	1000	2835	2	¾"	2"	<b>C115</b>	<b>C115BU</b>
2"	2.375"	1000	4430	2	½"	2¾"	<b>C12</b>	<b>C12BU</b>
2½"	2.875"	1000	6492	2	½"	2¾"	<b>C125</b>	<b>C125BU</b>
3"	3.500"	1000	9621	2	½"	3"	<b>C13</b>	<b>C13BU</b>
4"	4.500"	1000	15904	2	⅝"	3¼"	<b>C14</b>	<b>C14BU</b>
6"	6.625"	1000	34472	2	¾"	4¼"	<b>C16</b>	<b>C16BU</b>
8"	8.625"	800	46741	2	⅞"	5"	<b>C18</b>	<b>C18BU</b>
10"	10.750"	800	72610	2	⅞"	5"	<b>C20</b>	<b>C20BU</b>
12"	12.750"	800	102141	2	⅞"	5"	<b>C24</b>	<b>C24BU</b>

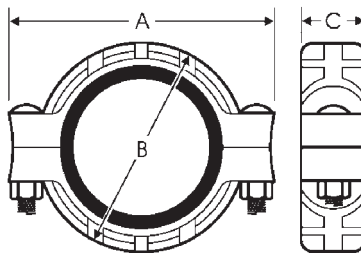

Dimensions

A	B	C
4-5/8"	3"	1-7/8"
5-15/64"	3-45/64"	1-27/32"
5-5/8"	4-1/4"	1-27/32"
6-21/32"	5"	1-27/32"
8-17/64"	6-3/8"	2-3/64"
11-7/32"	8-57/64"	2-3/64"
14-1/64"	11-3/8"	2-23/64"
16-5/8"	13-1/2"	2-5/8"
18-5/8"	15-1/2"	2-5/8"



Lightweight Flexible Couplings - Series L, Style 10

Pipe, Welding & Tube Fittings

Applications:

- designed for applications requiring moderate internal pressure or where weight is a factor such as general purpose, mining, irrigation, and compressed air where a deflection of 5% or less is required

Features:

- ductile iron body with rust inhibiting paint
- Underwriters Listed and Factory Mutual approved
- see pages 695, 701 for replacement gaskets, nuts and bolts
- Comparable to: Victaulic's #75 Grinnell's #7000



Nominal Size	Pipe OD	Maximum Working Pressure PSI at 70°F (21°C)	Maximum End Load (Lbs.)	Bolts			Ductile Iron	
				qty	size	length	Part # with EPDM gasket	Part # with Buna-N gasket
1½"	1.900"	500	1418	2	⅜"	2¼"	L215	L215BU
2"	2.375"	500	2215	2	⅜"	2"	L02	L02BU
2½"	2.875"	300	3246	2	⅜"	2"	L025	L025BU
3"	3.500"	300	4811	2	½"	2¾"	L03	L03BU
4"	4.500"	300	6362	2	½"	2¾"	L04	L04BU
5"	5.563"	300	9722	2	⅝"	3¼"	L05	L05BU
6"	6.625"	300	13789	2	⅝"	3¼"	L06	L06BU
8"	8.625"	300	20449	2	¾"	4¼"	L08	L08BU
10"	10.750"	350	29815	2	¾"	4¼"	L010	L010BU
12"	12.750"	350	40581	2	⅞"	5"	L012	L012BU

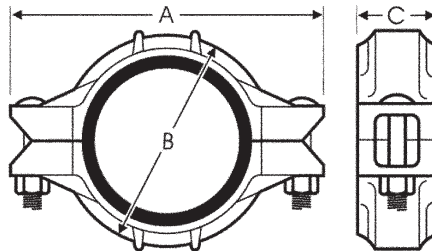

Dimensions

A	B	C
4-1/2"	2-29/32"	1-25/32"
4-7/8"	3-25/64"	1-27/32"
5-15/32"	3-45/64"	1-27/32"
6-27/64"	4-39/64"	1-27/32"
7-33/64"	5-7/8"	2 -1/64"
9-17/32"	7-3/32"	2 -1/64"
10-7/16"	8-7/64"	2-3/64"
13-15/32"	10-5/32"	2-13/32"
15-3/4"	12-39/64"	2-9/16"
18-23/64"	15-7/16"	2-9/16"

Lite® Couplings - Stainless Steel



**Applications:**

- designed for use on rigid, locked-in pipe connections

**Features:**

- 316 cast stainless steel body, nuts and bolts
  - certified to ANSI/NSF 61
  - ideal for corrosive environments
  - use of suitable anti-galling thread compound is recommended
- Comparable to: Grinnell's #7400 SS



Nominal Size	Pipe OD	Maximum Working Pressure (PSI)	Maximum End Load (Lbs.)	Bolts			316 Stainless Steel Part # with Fluoro-elastomer gasket
				qty	size	length	
2"	2.375"	300	1329	2	3/8"	2 1/4"	<b>RL02V</b>
3"	3.500"	300	2886	2	1/2"	2 3/4"	<b>RL03V</b>
4"	4.500"	300	4771	2	1/2"	2 3/4"	<b>RL04V</b>

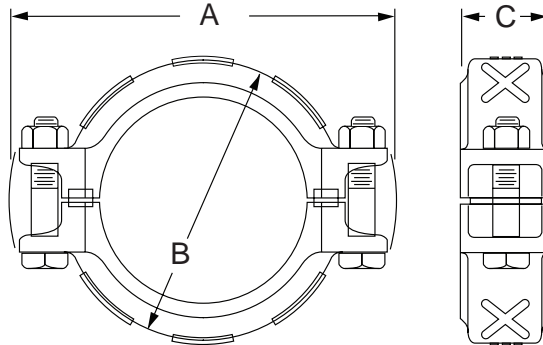

Dimensions

A	B	C
5 5/8"	3 5/8"	1 3/4"
6 5/8"	4 5/8"	1 3/4"
7 3/4"	6"	1 7/8"



Rigid Couplings - Series R, Style 5

Pipe, Welding & Tube Fittings

Application:

- ideal for fire protection, plumbing, low pressure air and drainage

Features:

- lightweight, low pressure
- galvanized ductile iron body
- small gripping teeth hold the housing into the groove allowing a straight run of pipe and preventing any flex at the joint
- Underwriters Listed and Factory Mutual approved
- see pages 695, 701 for replacement gaskets, nuts and bolts



Nominal Size	Pipe OD	Maximum Working Pressure PSI at 70°F (21°C)	Maximum End Load (Lbs.)	Bolts			Ductile Iron	
				qty	size	length	Part # with EPDM gasket	Part # with Buna-N gasket
2"	2.375"	175	4425	2	3/8"	2"	<b>R72</b>	<b>R72BU</b>
2½"	2.875"	175	6490	2	3/8"	2"	<b>R725</b>	<b>R725BU</b>
3"	3.500"	175	9620	2	½"	2¾"	<b>R73</b>	<b>R73BU</b>
4"	4.500"	175	12720	2	½"	2¾"	<b>R74</b>	<b>R74BU</b>
6"	6.625"	175	27570	2	5/8"	3¼"	<b>R76</b>	<b>R76BU</b>
8"	8.625"	175	35050	2	¾"	4¼"	<b>R78</b>	<b>R78BU</b>

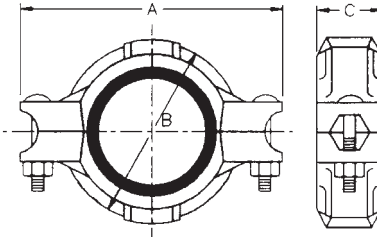

Dimensions

A	B	C
4-7/8"	3-17/32"	1-27/32"
5-5/8"	3-45/64"	1-3/4"
6-3/8"	4-41/64"	1-27/32"
7-45/64"	5-15/16"	2"
10-25/32"	8-7/64"	2-3/64"
13-25/32"	10"	2-21/64"



## Grooved Bolted Clamps

## Features:

- 2" pressure rating: **400 PSI**
- 3" pressure rating: **170 PSI**
- 4" pressure rating: **120 PSI**
- bolt torque: 20 ft. lbs.
- precision casting and machined dimensions provide an exact fit and great appearance
- use of lock nuts prevents clamps from loosening in high vibration applications
- leak-tight connection
- are intended for tank truck applications only 
- Unlike steel groove clamps that secure pipe ends with high clamp force against the tubing walls, the Dixon® bolted clamp takes the full bolt force and locks in the groove of the tube preventing distortion of the tube diameter.
- FKM-B rated for 100% biodiesel and Ethanol
- Buna-N rated for petroleum service, Ethanol to E100 and biodiesel to B20
- Baylast™ rated for petroleum service, Ethanol to E100 and biodiesel to B100
- white buna-N for use in dry bulk food applications
- temperature ratings for FKM-B is **20°F to 300°F (-7°C to 149°C)**
- temperature ratings for Baylast is **-20°F to 180°F (-29°C to 82°C)**

Size	Gasket Material	Aluminum Part #
2"	<i>FKM-B</i>	<b>DBV-VB200</b>
3"	<i>FKM-B</i>	<b>DBV-VB300</b>
4"	<i>FKM-B</i>	<b>DBV-VB400</b>
2"	<i>buna-N</i>	<b>DBV-BN200</b>
3"	<i>buna-N</i>	<b>DBV-BN300</b>
4"	<i>buna-N</i>	<b>DBV-BN400</b>
2"	<i>Baylast™</i>	<b>DBV-BL200</b>
3"	<i>Baylast™</i>	<b>DBV-BL300</b>
4"	<i>Baylast™</i>	<b>DBV-BL400</b>
4"	<i>white buna-N</i>	<b>DBV-WB400</b>



clamp with black buna gasket  
Note: Supplied clamp gasket must be installed prior to use, ships separately.

## Replacement Gaskets

Size	Material	Part #
2"	<i>FKM-B</i>	<b>G200VB</b>
3"	<i>FKM-B</i>	<b>G300VB</b>
4"	<i>FKM-B</i>	<b>G400VB</b>
3"	<i>buna-N</i>	<b>G300T</b>
4"	<i>buna-N</i>	<b>G400T</b>
2"	<i>Baylast™</i>	<b>G200BL</b>
3"	<i>Baylast™</i>	<b>G300BL</b>
4"	<i>Baylast™</i>	<b>G400BL</b>
4"	<i>white buna-N</i>	<b>G400N</b>



## Painted Iron Clamps with Baylast™ Gaskets

## Features:

- painted red
- Baylast™ seal is rated for biodiesel, Ethanol, diesel, gas and ULSD

Size	Maximum PSI	Iron Part #
2"	<b>500</b>	<b>L02BL</b>
3"	<b>300</b>	<b>L03BL</b>
4"	<b>300</b>	<b>L04BL</b>





Mechanical Tees - Series T

Features:

- Provides a fast easy way to install a threaded connection along a length of pipe. After drilling or cutting a hole in the pipe at the location of the branch connection, simply attach the clamps around the pipe for a leak-free threaded outlet connection. See chart below for drilling hole specifications
- ductile iron body with rust inhibiting paint
- supplied with EPDM gasket
- Underwriters Listed and Factory Mutual approved
- maximum operating pressure: **300 PSI at 70°F (21°C)**
- see pages 695, 701 for replacement gaskets, nuts and bolts
- Comparable to: Victaulic's #920 Grinnell's #7045

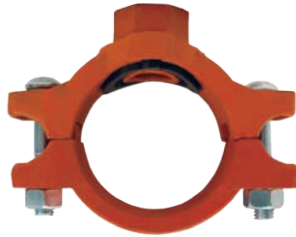

Nominal Size	Branch Size	Hole Saw Diameter	Maximum End Load (Lbs.)	Bolts			Ductile Iron Part #
				qty	size	length	
2"	1"	1 1/2"	1 5/8"	2	3/8"	2"	<b>MT2010</b>
	1 1/4"	1 3/4"	1 7/8"	2	3/8"	2"	<b>MT20125</b>
	1 1/2"	1 3/4"	1 7/8"	2	3/8"	2"	<b>MT20150</b>
2 1/2"	1 1/4"	2"	2 1/8"	2	1/2"	2 5/8"	<b>MT250125</b>
3"	1"	1 1/2"	1 5/8"	2	1/2"	2 3/4"	<b>MT3010</b>
	1 1/2"	2"	2 1/8"	2	1/2"	2 3/4"	<b>MT30150</b>
4"	1"	1 1/2"	1 5/8"	2	1/2"	2 3/4"	<b>MT4010</b>
	1 1/4"	2"	2 1/8"	2	1/2"	2 3/4"	<b>MT40125</b>
	1 1/2"	2"	2 1/8"	2	1/2"	2 3/4"	<b>MT40150</b>
	2"	2 1/2"	2 5/8"	2	1/2"	2 3/4"	<b>MT4020</b>
	2 1/2"	2 3/4"	2 7/8"	2	1/2"	2 3/4"	<b>MT40250</b>
3"	3 1/2"	3 5/8"	3 5/8"	2	1/2"	2 3/4"	<b>MT4030</b>
6"	1 1/4"	2 1/2"	2 5/8"	2	5/8"	3 1/4"	<b>MT60125</b>
	1 1/2"	2 1/2"	2 5/8"	2	5/8"	3 1/4"	<b>MT60150</b>
	2"	2 1/2"	2 5/8"	2	5/8"	3 1/4"	<b>MT6020</b>
	3"	3 1/2"	3 5/8"	3 5/8"	2	5/8"	3 1/4"

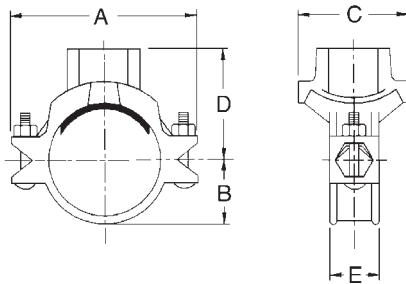

Dimensions

A	B	C	D	E
4 1/2"	1 3/8"	2 3/4"	2 1/4"	1 7/8"
4 1/2"	1 3/8"	2 3/4"	2 1/2"	1 7/8"
4 1/2"	1 3/8"	2 3/4"	2 1/2"	1 7/8"
5-5/32"	1-11/16"	3"	2-31/32"	2"
5-13/16"	1-11/16"	3-11/32"	3"	2"
6-11/32"	2-1/8"	3-3/32"	3-1/16"	2"
6-11/32"	2-1/8"	3-3/4"	3-3/8"	2"
7-5/16"	2-9/16"	3-3/32"	3-1/2"	2"
7-5/16"	2-9/16"	3-3/4"	3-7/8"	2"
7-5/16"	2-9/16"	3-3/4"	3-7/8"	2"
7-5/16"	2-9/16"	4-1/8"	4"	2"
7-5/16"	2-9/16"	4-3/8"	4"	2"
7-5/16"	2-9/16"	5-1/4"	4-1/4"	2"
10-5/32"	3-11/16"	4-1/8"	4-7/8"	2 1/4"
10-5/32"	3-11/16"	4-1/8"	4-7/8"	2 1/4"
10-5/32"	3-11/16"	4-1/8"	5"	2 1/4"
10-5/32"	3-11/16"	5-1/4"	5-3/8"	2 1/4"

## Flange Adapters - Series FA

**Application:**

- used to connect an ANSI Class 125 and 150 flange to a grooved pipe using a grooved clamp

**Features:**

- Provides a rigid one piece connection that can be disconnected by removing the clamp assembly. To assemble to another flange, position bolt heads on the adapter (grooved) side.
- ductile iron body with rust inhibiting paint

Nominal Size	Pipe OD	Maximum Working Pressure PSI at 70°F (21°C)	Flange Dimensions		Bolts		Ductile Iron Part #
			A	B	qty	size	
2"	2.375"	300	6"	2-3/8"	4	5/8"	<b>FA20</b>
3"	3.500"	300	7 1/4"	2-3/8"	4	5/8"	<b>FA30</b>
4"	4.500"	300	8 1/2"	2-3/8"	8	5/8"	<b>FA40</b>
6"	6.625"	300	11"	2-9/16"	8	3/4"	<b>FA60</b>
8"	8.625"	300	13 1/4"	3"	8	3/4"	<b>FA80</b>

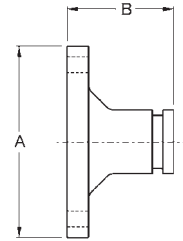

## ANSI Split Flanges - Series SF

**Features:**

- provides a direct connection between a grooved adapter and an ANSI Class 125 and 150 raised face flanged component
  - can be used with flat face flanges by removing the raised projections on the outside face of the flange.
  - ductile iron body with rust inhibiting paint
  - Underwriters Listed and Factory Mutual approved
  - Buna gaskets are available upon request
- Comparable to:  
Victaulic's #741  
Grinnell's #7012

Nom. Size	Pipe OD	Max. Work. Press. PSI at 70°F (21°C)	Flange Dims.		Bolts		Ductile Iron with Gasket Part # <sup>1</sup>	Replacement EPDM Gaskets Part # <sup>2</sup>
			A	B	qty	size		
2"	2.375"	300	6"	13/16"	4	5/8"	<b>ANSI20</b>	<b>FLG200E</b>
2 1/2"	2.875"	300	7"	13/16"	4	5/8"	<b>ANSI25</b>	<b>FLG250E</b>
3"	3.500"	300	7 1/2"	13/16"	4	5/8"	<b>ANSI30</b>	<b>FLG300E</b>
4"	4.500"	300	9"	15/16"	8	5/8"	<b>ANSI40</b>	<b>FLG400E</b>
6"	6.625"	300	11"	1"	8	3/4"	<b>ANSI60</b>	<b>FLG600E</b>
8"	8.625"	300	13 1/2"	1-1/8"	8	3/4"	<b>ANSI80</b>	<b>FLG800E</b>

<sup>1</sup> with EPDM gasket

<sup>2</sup> replacement gasket

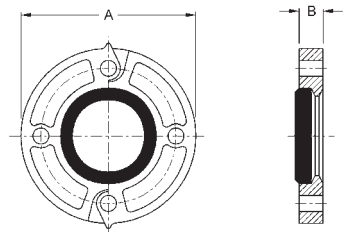

## Reducing Adapters - Series RA

**Features:**

- ductile iron body with rust inhibiting paint
- Underwriters Listed and Factory Mutual approved
- Comparable to:  
Victaulic's #50, Grinnell's #7072

Nominal Size	Nominal Size	Dimensions E to E	Ductile Iron Part #
2"	1 1/2"	2.5"	<b>RAGG20150</b>
2 1/2"	2"	2.5"	<b>RAGG25020</b>
3"	2"	2.5"	<b>RAGG3020</b>
	2 1/2"	2.5"	<b>RAGG30250</b>
4"	2"	3.0"	<b>RAGG4020</b>
	2 1/2"	3.0"	<b>RAGG40250</b>
	3"	3.0"	<b>RAGG4030</b>
5"	4"	3.5"	<b>RAGG5040</b>
	2"	4.0"	<b>RAGG6020</b>
6"	2 1/2"	4.0"	<b>RAGG60250</b>
	3"	4.0"	<b>RAGG6030</b>
	4"	4.0"	<b>RAGG6040</b>

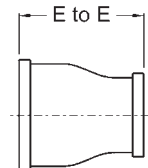



Grooved End Fittings - Series 45

Series 45

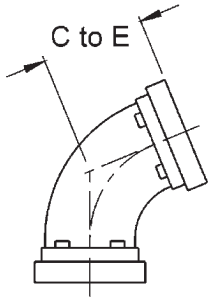

Features:

- designed to provide minimum pressure drop and uniform strength
- maximum operating pressure: **500 PSI** at ambient temperature **70°F (21°C)**
- ductile iron body with rust inhibiting paint
- Underwriters Listed and Factory Mutual approved
- Comparable to:  
Victaulic's #110  
Grinnell's #7051

Nominal Size	Dimensions C to E	Ductile Iron Part #
2"	2"	<b>L2045</b>
2½"	2¼"	<b>L2545</b>
3"	2½"	<b>L3045</b>
4"	3"	<b>L4045</b>
5"	3¼"	<b>L5145</b>
6"	3½"	<b>L6045</b>
8"	4¼"	<b>L8045</b>



Series 90

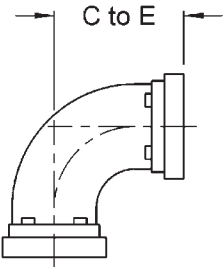

Features:

- designed to provide minimum pressure drop and uniform strength
- maximum operating pressure: **500 PSI** at ambient temperature **70°F (21°C)**
- ductile iron body with rust inhibiting paint
- Underwriters Listed and Factory Mutual approved
- Comparable to:  
Victaulic's #10  
Grinnell's #7050

Nominal Size	Dimensions C to E	Ductile Iron Part #
2"	3¼"	<b>L502</b>
2½"	3¾"	<b>L5025</b>
3"	4¼"	<b>L503</b>
4"	5"	<b>L504</b>
6"	6½"	<b>L506</b>
8"	7¾"	<b>L508</b>



Series T

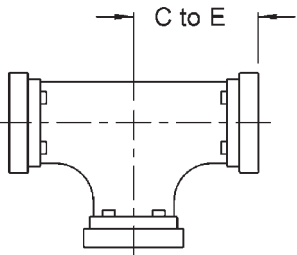

Features:

- designed to provide minimum pressure drop and uniform strength
- maximum operating pressure: **500 PSI** at ambient temperature **70°F (21°C)**
- ductile iron body with rust inhibiting paint
- Underwriters Listed and Factory Mutual approved
- Comparable to:  
Victaulic's #20  
Grinnell's #7060

Nominal Size	Dimensions C to E	Ductile Iron Part #
2"	3¼"	<b>T602</b>
2½"	3¾"	<b>T6025</b>
3"	4¼"	<b>T603</b>
4"	5"	<b>T604</b>
6"	6½"	<b>T606</b>
8"	7¾"	<b>T608</b>

## ANSI Caps with Tapped Outlet - Series EC

## Feature:

- painted with rust inhibiting paint

Nominal Size	Outlet	Dimensions E to E	Ductile Iron Part #
2"	1"	7/8"	<b>EC201</b>
2½"	1"	7/8"	<b>EC251</b>
3"	1"	7/8"	<b>EC301</b>
4"	1"	1"	<b>EC401</b>
	2"	1"	<b>EC402</b>
6"	1"	1"	<b>EC601</b>
	2"	1"	<b>EC602</b>
8"	2"	1-3/16"	<b>EC802</b>

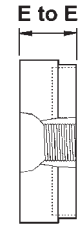
Pipe, Welding  
& Tube Fittings

## Blank Caps - Series BE



## Features:

- painted with rust inhibiting paint
- Underwriters Listed and Factory Mutual approved
- Comparable to:  
Victaulic's #60  
Grinnell's #7074

Nominal Size	Dimensions E to E	Ductile Iron Part #
2"	7/8"	<b>BEC20</b>
2½"	7/8"	<b>BEC25</b>
3"	7/8"	<b>BEC30</b>
4"	1"	<b>BEC40</b>
6"	1"	<b>BEC60</b>
8"	1-3/16"	<b>BEC80</b>



## Long Pipe Style Nipples - Series AN

Groove x NPT	Dimensions E to E	Carbon Steel Part #
2"	4"	<b>A712</b>
2½"	4"	<b>A7125</b>
3"	4"	<b>A713</b>
4"	6"	<b>A714</b>
5"	6"	<b>A715</b>
6"	6"	<b>A716</b>

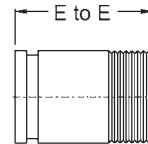

## Grooved End x Weld Nipples

Nominal Size	Aluminum Part #	Carbon Steel Part #	316 Stainless Steel Part #
2"	<b>AVN2000-200</b>	<b>VN2000-200</b>	<b>VNR2000-200</b>
2½"	<b>AVN2500-200</b>	<b>VN2500-200</b>	<b>VNR2500-200</b>
3"	<b>AVN3000-200</b>	<b>VN3000-200</b>	<b>VNR3000-200</b>
4"	<b>AVN4000-200</b>	<b>VN4000-200</b>	<b>VNR4000-200</b>



- For additional information on pipe dimensions please reference [dixonvalve.com](http://dixonvalve.com).

## Grooved End Butterfly Valves

## Features:

- for water and air applications
- working pressure: **300 PSI**
- maximum temperature: **210°F (99°C)**
- material: **body:** ductile iron, epoxy coated; **disc:** ductile iron, EPDM encapsulated; **stem:** stainless steel; **notch plate:** zinc plated steel; **seals:** EPDM

Size	Ductile Iron Part #
2"	<b>GIBFV200</b>
2½"	<b>GIBFV250</b>
3"	<b>GIBFV300</b>
4"	<b>GIBFV400</b>
6"	<b>GIBFV600</b>
8"	<b>GIBFV800</b>



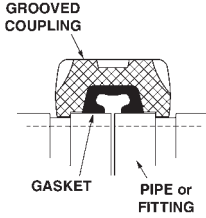

## Grooved Fitting Gaskets

- check gasket color code to be certain it is recommended for the service intended
- use lubricant on gasket (reference next page)
- for services not listed contact Dixon® for recommendations

### FKM Gaskets

**Features:**

- temperature range: **-13°F to 350°F (-11°C to 177°C)**
- color code: black with blue stripe
- resistant to oxidizing acids, petroleum oils, hydraulic fluids, halogenated hydrocarbons and lubricants



Size	FKM Part #
2"	<b>G200V</b>
3"	<b>G300V</b>
4"	<b>G400V</b>
6"	<b>G600V</b>
8"	<b>G800V</b>
10"	<b>G1000V</b>
12"	<b>G1200V</b>

### EPDM Gaskets

**Features:**

- temperature range: **-22°F to 230°F (-30°C to 110°C)**
- color code: black with green stripe
- for water, dilute acids, alkalis, salts, and many chemical services not involving hydrocarbons, oils, or gases
- excellent oxidation resistance
- *not for use with hydrocarbons* 



Size	EPDM Part #
1½"	<b>G150E</b>
2"	<b>G200E</b>
2½"	<b>G250E</b>
3"	<b>G300E</b>
4"	<b>G400E</b>
5"	<b>G500E</b>
6"	<b>G600E</b>
8"	<b>G800E</b>
10"	<b>G1000E</b>
12"	<b>G1200E</b>

### Buna Gaskets

**Features:**

- temperature range: **-24°F to 176°F (-31°C to 80°F)**
- for petroleum products, vegetable oils, mineral oils, and air contaminated with petroleum oils
- *not for use in hot water services* 



Size	Black Buna with orange stripe Part #	White Buna Part #
1½"	<b>G150T</b>	---
2"	<b>G200T</b>	---
2½"	<b>G250T</b>	---
3"	<b>G300T</b>	---
4"	<b>G400T</b>	<b>G400N</b>
5"	<b>G500T</b>	---
6"	<b>G600T</b>	---
8"	<b>G800T</b>	---
10"	<b>G1000T</b>	---
12"	<b>G1200T</b>	---

## Grooved Fitting Accessories

## Nuts and Bolts

**Features:**

- the nuts are a heavy hexagon design
- specifically designed for use with the couplings on pages 691-696

**Specification:**

- conforms to ASTM A183

Bolt Thread	Bolt Length	Torque Ft. Lbs.	Electroplated Carbon Steel Part #
3/8"	2"	30	<b>BLT38200</b>
3/8"	2¼"	30	<b>BLT38225</b>
1/2"	2½"	50	<b>BLT50212</b>
1/2"	2¾"	50	<b>BLT50234</b>
1/2"	3"	50	<b>BLT50300</b>
5/8"	3¼"	75	<b>BLT58314</b>
3/4"	4¼"	75	<b>BLT75414</b>
7/8"	5"	200	<b>BLT78500</b>



## Groove Lube

**Features:**

- water soluble
- non-toxic
- non-corrosive
- non-flammable
- *should not be used with HDPE pipe*

**Specification:**

- NSF approved for use with potable water

Size	Container	Part #
1 qt.	Tub	<b>GROOVLUB32</b>



## High Density Polyethylene (HDPE) Couplings

Pipe, Welding  
& Tube Fittings

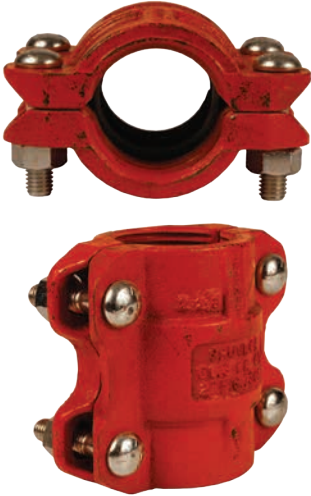

**Applications:**

- designed for mechanically joining high density polyethylene pipe and fittings

**Features:**

- ductile iron body with rust inhibiting paint
- uses four bolts to drive the sharply machined housing teeth into the outside of the pipe

- Comparable to:  
Grinnell's #9095

Nominal Size	Pipe OD	Bolts			Ductile Iron	
		qty	size	length	Part # with EPDM gasket	Part # with Buna-N gasket
2"	2.375"	4	1/2"	2 3/8"	<b>HDPE200</b>	<b>HDPE200BU</b>
3"	3.500"	4	1/2"	3"	<b>HDPE300</b>	<b>HDPE300BU</b>
4"	4.500"	4	1/2"	3"	<b>HDPE400</b>	<b>HDPE400BU</b>
6"	6.625"	4	5/8"	3 1/2"	<b>HDPE600</b>	<b>HDPE600BU</b>

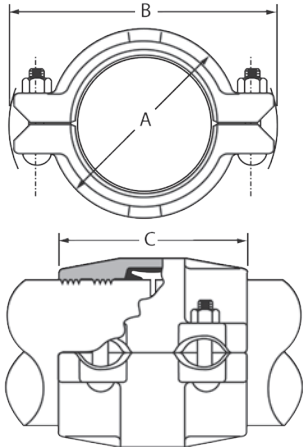

**Dimensions**

A	B	C
3 3/8"	5 1/2"	4 5/8"
4 5/8"	6 3/4"	4 5/8"
5 1/4"	8"	5 3/4"
7 1/2"	11"	5 7/8"



## Y Line Strainers

## Cast Iron

## Features:

- graphite gasket
- working pressure: **400 PSI WOG, 250 PSI steam**
- plug ported for blowdown service
- no replacement screens available

Female NPT	Description	Cast Iron Part #
1/4"	20 x 20 mesh	Y001
3/8"		Y002
1/2"		Y003
3/4"		Y004
1"		Y005
1 1/4"		Y006
1 1/2"		Y007
2"		Y008



## Cast Bronze

## Feature:

- working pressure: **400 PSI WOG, 125 PSI steam**

Female NPT	Description	Cast Bronze Part #	304 Stainless Replacement Screens Part #
1/4"	50 x 50 mesh	59-001	G3271-00
3/8"	50 x 50 mesh	59-002	G2457-00
1/2"	50 x 50 mesh	59-003	G2457-00
3/4"	20 x 20 mesh	59-004	G3224-00
1"	20 x 20 mesh	59-005	G3225-00
1 1/4"	20 x 20 mesh	59-006	G3231-00
1 1/2"	20 x 20 mesh	59-007	G3229-00
2"	20 x 20 mesh	59-008	G3230-00



replacement screen

## Polypropylene

## Features:

- protects and prevents clogging of pipelines, pumps and spray tips
- glass-filled polypropylene body
- easy access for cleaning
- maximum operating pressure: **90 PSI at 70°F (21°C)**

Female NPT	Description	Polypropylene Part #	304 Stainless Replacement Screens Part #
3/4"	40 mesh	PYLS7540	64178
1"	40 mesh	PYLS10040	61746
1 1/2"	40/20 mesh	PYLS15040	61509
2"	40/20 mesh	PYLS20040	61509



replacement screen

## Polypropylene T Line Strainers

## Features:

- white polypropylene allows easy inspection
- maximum operating pressure: **100 PSI at 70°F (21°C)**

Female NPT	Description	Polypropylene Part #	304 Stainless Replacement Screens Part #
3/4"	50 mesh	PTLS7540	61405
1"	40 mesh	PTLS10040	61405



LP Gas Couplings and Adapters

**Specifications:**

- products meet or exceed the requirements of Compressed Gas Association (CGA), the National Fire Protection Association (NFPA), the Canadian Gas Association, American Society of Mechanical Engineers (ASME) and Underwriters Laboratories (UL)

Pipe, Welding & Tube Fittings

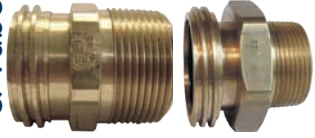

ME217

ME233



ME502-12/8

ME503-16

**Male Acme x Male NPT Adapters**

Male Acme	Male NPT	Female NPT	Brass Part #
1 3/4"	1 1/4"	--	<b>ME217</b>
2 1/4"	1 1/4"	--	<b>ME233</b>
2 1/4"	1 1/2"	1"	<b>ME502-12/8</b> <sup>1</sup>
3 1/4"	2"	--	<b>ME503-16</b>

<sup>1</sup> dual threads - male outside / female inside

**Male Acme x Female NPT Adapters**



Male Acme	Female NPT	Brass Part #
1 3/4"	1"	<b>ME214</b>
3 1/4"	2"	<b>ME252-16</b>

**Male Acme x Male NPT Adapters**



ME217S

ME503S-16

Male Acme	Male NPT	Steel Part #
1 3/4"	1 1/4"	<b>ME217S</b>
2 1/4"	1 1/4"	<b>ME233S</b>
3 1/4"	2"	<b>ME503S-16</b>

**Male Acme x Female NPT Adapter**



Male Acme	Female NPT	Steel Part #
3 1/4"	2"	<b>ME252S-16</b>

**Female Acme x Male Acme Adapters**



brass

steel

Female Acme	Male Acme	Material	Part #
3 1/4"	1 3/4"	brass	<b>ME612</b>
3 1/4"	1 3/4"	steel	<b>ME612S</b>

LP Gas Couplings and Adapters

Female Acme x Male NPT Filler Couplings, Brass Nut

Female Acme	Male NPT	Material	Part #
1 3/4"	1"	brass nut, brass nipple	<b>ME112</b>
2 1/4"	1 1/4"	brass nut, brass nipple	<b>ME120</b>
2 1/4"	1 1/4"	brass nut, steel nipple	<b>ME120S</b>
3 1/4"	2"	brass nut, steel nipple	<b>ME130</b>

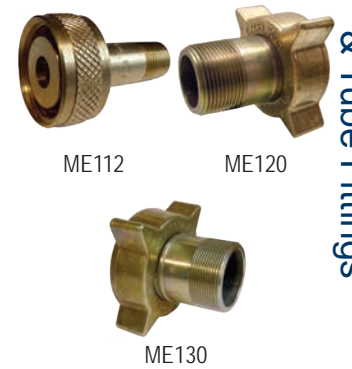

Pipe, Welding & Tube Fittings

Female Acme x Male NPT Filler Couplings, Steel Nut

Female Acme	Male NPT	Steel Part #
1 3/4"	1"	<b>ME112S</b>
2 1/4"	1 1/4"	<b>ME121S</b>
3 1/4"	2"	<b>ME130S</b>



Acme Gaskets

Size	Nitrile Part #
1 3/4"	<b>MEW2</b>
2 1/4"	<b>MEW5</b>
3 1/4"	<b>MEW6</b>



Clamp Style Hose Couplings

Features:

- clamp sections and hose barbs are made of steel and ductile iron
- 32B and 32S sizes offer a female Acme swivel to eliminate the need to add additional weight and bulk to the hose assembly

Hose Barb	Thread Size	Material	Part #
1"	1" male NPT	steel nipple, 2-piece ductile iron clamp	<b>ME3162-16</b>
1 1/4"	1 1/4" male NPT	steel nipple, 2-piece ductile iron clamp	<b>ME3162-20</b>
1 1/2"	1 1/2" male NPT	steel nipple, 2-piece ductile iron clamp	<b>ME3162-24</b>
2"	2" male NPT	steel nipple, 2-piece ductile iron clamp	<b>ME3162-32</b>
2"	3 1/4" female Acme	steel nipple, brass nut, 2-piece ductile iron clamp	<b>ME3162-32B</b>
2"	3 1/4" female Acme	steel nipple, steel nut, 2-piece ductile iron clamp	<b>ME3162-32S</b>



Acme Spanner Wrench

Feature:

- used on 1 3/4", 2 1/4", 3 1/4" and 4 1/4" fittings

Aluminum Part #
<b>MEP120B</b>



LP Gas Hose Caps and Plugs



ME229



ME441F

Metal Caps

Female Acme Threads	Description	Material	Part #
1 3/4"	cap with ring and chain	brass	<b>ME229-1</b>
1 3/4"	cap with ring and chain	steel	<b>ME229S-1</b>
2 1/4"	cap with knob plug and chain	brass	<b>ME431F-1</b>
2 1/4"	cap with knob plug, ring and chain	steel	<b>ME431FS-1</b>
3 1/4"	cap with knob plug, ring and chain	brass	<b>ME441F-1</b>
3 1/4"	cap with knob plug, ring and chain	steel	<b>ME441FS-1</b>

Plastic Caps



ME109-1



ME109-NH3-1

Female Acme Threads	Description	Plastic Part #
1 3/4"	cap with ring and chain, yellow	<b>ME109-1</b>
1 3/4"	cap with chain assembly, for anhydrous service	<b>ME109-NH3-1</b>

Plastic Dust Plugs



ME179-1



ME180-1



ME181-1

Male Acme Threads	Description	Plastic Part #
1 3/4"	plug with dust seal and chain assembly, yellow	<b>ME179-1</b>
2 1/4"	plug with dust seal and chain assembly, yellow	<b>ME180-1</b>
3 1/4"	plug with dust seal and chain assembly, yellow	<b>ME181-1</b>

## Instrumentation Fittings

**Applications:**

- high pressure
- high temperature
- nitrogen
- helium
- flammable gases
- hydraulic gases
- corrosive media
- pneumatic automation

**Features:**

- Instrumentation fittings come completely assembled.
- fully interchangeable with Swagelok® and Parker A-Lok®, all fittings are ASTM F 1387 Certified
- double collet (ferrule) swaging action
- two positive seal points
- ASTM 316 stainless steel material construction
- temperature range: **-325°F to 1200°F (-198°C to 648°C)**
- pressure ratings: see chart to the left, ratings listed are for reference only

**Installation Instructions:**

1. Cut tubing squarely and clean tube end thoroughly to remove burrs.
2. Insert the tubing into the assembly making sure the tubing seats firm against the shoulder of the body and the nut is finger tight.
3. Tighten the nut with a wrench 1¼ turns, while holding the body with a second wrench.

**Suggested Working Pressures (PSI)**

wall thk.	.028	.035	.049	.065	.083	.095	.109
¼"	<b>4,000</b>	<b>5,100</b>	<b>7,500</b>	<b>10,100</b>	---	---	---
⅜"	---	<b>3,300</b>	<b>4,700</b>	<b>6,600</b>	---	---	---
½"	---	<b>2,600</b>	<b>3,700</b>	<b>5,000</b>	<b>6,600</b>	---	---
⅝"	---	---	<b>2,900</b>	<b>3,900</b>	<b>5,200</b>	<b>6,000</b>	---
¾"	---	---	<b>2,400</b>	<b>3,200</b>	<b>4,200</b>	<b>4,900</b>	<b>5,700</b>

**Safety Guidelines:**

- Never connect, disconnect or remake a fitting with pressure in the system.
- Make sure all fittings are properly installed.
- It is not recommended to go beyond the pressure rating of the tubing. Elongation could occur in the tubing, shrinking the wall thickness and causing potential harm.
- For proper sealing it is recommended that the tubing and fittings be of like material.
- Always use proper thread lubricant and sealants on tapered pipe threads.
- Never bleed a system by loosening a fitting.

Pipe, Welding & Tube Fittings

### Male Connectors

Tube OD	Male NPT	Interchanges	316 Stainless Steel Part #	Pkg Qty
⅛"	⅛"-27 ¼"-18	200-1-2	<b>2-DMC-2</b>	10
		200-1-4	<b>2-DMC-4</b>	10
¼"	¼"-18 ⅜"-18 ½"-14	400-1-2	<b>4-DMC-2</b>	10
		400-1-4	<b>4-DMC-4</b>	10
		400-1-6	<b>4-DMC-6</b>	10
		400-1-8	<b>4-DMC-8</b>	10
⅜"	¼"-18 ⅜"-18 ½"-14	600-1-4	<b>6-DMC-4</b>	10
		600-1-6	<b>6-DMC-6</b>	10
		600-1-8	<b>6-DMC-8</b>	10
½"	¼"-18 ⅜"-18 ½"-14	810-1-4	<b>8-DMC-4</b>	10
		810-1-6	<b>8-DMC-6</b>	10
		810-1-8	<b>8-DMC-8</b>	10
⅝"	½"-14	1010-1-8	<b>10-DMC-8</b>	10
¾"	½"-14 ¾" 1"	1210-1-8	<b>12-DMC-8</b>	10
		1210-1-12	<b>12-DMC-12</b>	10
		1210-1-16	<b>12-DMC-16</b>	10
1"	¾" 1"	1610-1-12	<b>16-DMC-12</b>	10
		1610-1-16	<b>16-DMC-16</b>	10



### Female Connectors

Tube OD	Female NPT	Interchanges	316 Stainless Steel Part #	Pkg Qty
⅛"	⅛"-27	200-7-2	<b>2-DFC-2</b>	10
¼"	⅛"-27 ¼"-18	400-7-2	<b>4-DFC-2</b>	10
		400-7-4	<b>4-DFC-4</b>	10
⅜"	¼"-18 ½"-14	600-7-4	<b>6-DFC-4</b>	10
		600-7-8	<b>6-DFC-8</b>	10
½"	½"-14	810-7-8	<b>8-DFC-8</b>	10
⅝"	½"	1010-7-8	<b>10-DFC-8</b>	10
¾"	½" ¾"	1210-7-8	<b>12-DFC-8</b>	10
		1210-7-12	<b>12-DFC-12</b>	10
1"	1"	1610-7-16	<b>16-DFC-16</b>	10



K

Instrumentation Fittings

Pipe, Welding  
& Tube Fittings



Unions

Tube OD	Interchanges	316 Stainless Steel Part #	Pkg Qty
1/8" x 1/8"	200-6	<b>2-DU</b>	10
1/4" x 1/8"	400-6-2	<b>4-DU-2</b>	10
1/4" x 1/4"	400-6	<b>4-DU</b>	10
3/8" x 1/4"	600-6-4	<b>6-DU-4</b>	10
3/8" x 3/8"	600-6	<b>6-DU</b>	10
1/2" x 1/2"	810-6	<b>8-DU</b>	10
5/8" x 5/8"	1010-6	<b>10-DU</b>	10
3/4" x 3/4"	1210-6	<b>12-DU</b>	10
1" x 1"	1610-6	<b>16-DU</b>	10

Bulkhead Unions



Tube OD	Interchanges	316 Stainless Steel Part #	Pkg Qty
1/4"	400-61	<b>4-DBHU-4</b>	10
3/8"	600-61	<b>6-DBHU-6</b>	10
1/2"	810-61	<b>8-DBHU-8</b>	10
5/8"	1010-61	<b>10-DBHU-10</b>	10
3/4"	1210-16	<b>12-DBHU-12</b>	10
1"	1610-16	<b>16-DBHU-16</b>	10

Reducers



Tube OD	Interchanges	316 Stainless Steel Part #	Pkg Qty
1/4" x 1/8"	400-R-2	<b>4-DRATT-2</b>	10
3/8" x 1/4"	600-R-4	<b>6-DRATT-4</b>	10
3/8" x 1/2"	600-R-8	<b>6-DRATT-8</b>	10
1/2" x 3/4"	810-R-12	<b>8-DRATT-12</b>	10
3/4" x 1/2"	1210-R-8	<b>12-DRATT-8</b>	10
3/4" x 1"	1210-R-16	<b>12-DRATT-16</b>	10

Male Elbows



Tube OD	Male NPT	Interchanges	316 Stainless Steel Part #	Pkg Qty
1/4"	1/8"-27	400-2-2	<b>4-DME-2</b>	10
	1/4"-18	400-2-4	<b>4-DME-4</b>	10
3/8"	1/4"-18	600-2-4	<b>6-DME-4</b>	10
	3/8"-18	600-2-6	<b>6-DME-6</b>	10
1/2"	1/2"-14	810-2-8	<b>8-DME-8</b>	10
3/4"	1/2"-14	1210-2-8	<b>12-DME-8</b>	10
	3/4"	1210-2-12	<b>12-DME-12</b>	10
1"	3/4"	1610-2-12	<b>16-DME-12</b>	10
	1"	1610-2-16	<b>16-DME-16</b>	10

Female Elbows



Tube OD	Female NPT	Interchanges	316 Stainless Steel Part #	Pkg Qty
1/4"	1/8"-27	400-8-2	<b>4-DFE-2</b>	10
3/8"	1/4"-18	600-8-4	<b>6-DFE-4</b>	10
1/2"	1/2"-14	810-8-8	<b>8-DFE-8</b>	10
3/4"	1/2"	1210-8-8	<b>12-DFE-8</b>	10
3/4"	3/4"	1210-8-12	<b>12-DFE-12</b>	10
1"	1"	1610-8-16	<b>16-DFE-16</b>	10

Instrumentation Fittings

Union Elbows

Tube OD	Interchanges	316 Stainless Steel Part #	Pkg Qty
1/4"	400-9	<b>4-DELU-4</b>	10
3/8"	600-9	<b>6-DELU-6</b>	10
1/2"	810-9	<b>8-DELU-8</b>	10
5/8"	1010-9	<b>10-DELU-10</b>	10
3/4"	1210-9	<b>12-DELU-12</b>	10
1"	1610-9	<b>16-DELU-16</b>	10



Pipe, Welding & Tube Fittings

Male Branch Tees

Tube OD	Male NPT	Interchanges	316 Stainless Steel Part #	Pkg Qty
1/8"	1/8"-27	200-3TTM	<b>2-DTTM-2</b>	10
1/4"	1/4"-18	400-3-4TTM	<b>4-DTTM-4</b>	10
1/2"	3/8"	810-3TTM	<b>8-DTTM-6</b>	10
1/2"	1/2"	810-3-8TTM	<b>8-DTTM-8</b>	10
3/4"	1/2"	1210-3-8TTM	<b>12-DTTM-8</b>	10
3/4"	3/4"	1210-3TTM	<b>12-DTTM-12</b>	10
1"	3/4"	1610-3-12TTM	<b>16-DTTM-12</b>	10
1"	1"	1610-3-16TTM	<b>16-DTTM-16</b>	10



Female Branch Tees

Tube OD	Female NPT	Interchanges	316 Stainless Steel Part #	Pkg Qty
1/4"	1/4"-18	400-3-4TTF	<b>4-DTTF-4</b>	10



Union Tees

Tube OD	Interchanges	316 Stainless Steel Part #	Pkg Qty
1/4"	400-3	<b>4-DTTT-4</b>	10
3/8"	600-3	<b>6-DTTT-6</b>	10
1/2"	810-3	<b>8-DTTT-8</b>	10
5/8"	1010-3	<b>10-DTTT-10</b>	10
3/4" x 3/8"	1210-3-12-6	<b>12-DTTT-6</b>	10
3/4" x 1/2"	1210-3-12-8	<b>12-DTTT-8</b>	10
3/4"	1210-3	<b>12-DTTT-12</b>	10
1" x 3/4"	1610-3-12-16	<b>16-DTTT-12</b>	10
1"	1610-3	<b>16-DTTT-16</b>	10



Male Run Tees

Tube OD	Male NPT	Interchanges	316 Stainless Steel Part #	Pkg Qty
1/8"	1/8"-27	200-3TMT	<b>2-DTMT-2</b>	10
1/4"	1/4"-18	400-3-4TMT	<b>4-DTMT-4</b>	10
3/8"	1/4"-18	600-3TMT	<b>6-DTMT-4</b>	10
1/2"	3/8"	810-3TMT	<b>8-DTMT-6</b>	10
1/2"	1/2"	810-3-8TMT	<b>8-DTMT-8</b>	10
3/4"	3/4"	1210-3TMT	<b>12-DTMT-12</b>	10
1"	1"	1610-3-16TMT	<b>16-DTMT-16</b>	10

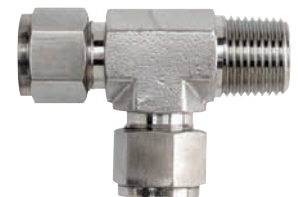

Instrumentation Fittings

Pipe, Welding  
& Tube Fittings



Front Ferrules

Tube OD	Interchanges	316 Stainless Steel Part #	Pkg Qty
1/8"	203-1	<b>DFC-2</b>	10
1/4"	403-1	<b>DFC-4</b>	10
3/8"	603-1	<b>DFC-6</b>	10
1/2"	813-1	<b>DFC-8</b>	10
5/8"	1013-1	<b>DFC-10</b>	10
3/4"	1213-1	<b>DFC-12</b>	10
1"	1613-1	<b>DFC-16</b>	10

Rear Ferrules



Tube OD	Interchanges	316 Stainless Steel Part #	Pkg Qty
1/8"	204-1	<b>DRC-2</b>	10
1/4"	404-1	<b>DRC-4</b>	10
3/8"	604-1	<b>DRC-6</b>	10
1/2"	814-1	<b>DRC-8</b>	10
5/8"	1014-1	<b>DRC-10</b>	10
3/4"	1214-1	<b>DRC-12</b>	10
1"	1614-1	<b>DRC-16</b>	10

Nuts



Tube OD	Interchanges	316 Stainless Steel Part #	Pkg Qty
1/4"	402-1	<b>DN-4</b>	10
3/8"	602-1	<b>DN-6</b>	10
1/2"	812-1	<b>DN-8</b>	10
5/8"	1012-1	<b>DN-10</b>	10
3/4"	1212-1	<b>DN-12</b>	10
1"	1612-1	<b>DN-16</b>	10

Caps



Tube OD	Interchanges	316 Stainless Steel Part #	Pkg Qty
1/4"	400-C	<b>4-DCAP</b>	10
3/8"	600-C	<b>6-DCAP</b>	10
1/2"	810-C	<b>8-DCAP</b>	10
5/8"	1010-C	<b>10-DCAP</b>	10
3/4"	1210-C	<b>12-DCAP</b>	10
1"	1610-C	<b>16-DCAP</b>	10

Plugs



Tube OD	Interchanges	316 Stainless Steel Part #	Pkg Qty
1/4"	400-P	<b>4-DFPLUG</b>	10
3/8"	600-P	<b>6-DFPLUG</b>	10
1/2"	810-P	<b>8-DFPLUG</b>	10
5/8"	1010-P	<b>10-DFPLUG</b>	10
3/4"	1210-P	<b>12-DFPLUG</b>	10
1"	1610-P	<b>16-DFPLUG</b>	10



Compression Fittings

**Applications:**

- for use with copper, aluminum and Parflex thermoplastic tubing
- not recommended for steel tubing or applications using gaseous media

**Features:**

- no flaring, soldering or other preparation of tubing necessary to assemble
- manufactured for connection to low and medium pressure tubing connection work where excessive vibration or tube movement is not involved
- Underwriter's Laboratories listed for flammable liquid
- Compression fittings meet functional requirements of SAE J-512 and ASA.

**Assembly Instructions:**

1. Slide nut, then sleeve onto tubing. The thread end of the nut must face outward.
2. Insert the tube into the fitting. Be sure the tube is bottomed on the fitting shoulder.
3. Assemble nut to body, than tighten hand-tight. Then follow the number of wrench turns as indicated in the table below.

Fitting Size	Tube OD	Tube Wall	Turns required to seal from hand-tight		PSI @ 73°F (23°C)
			60C Series with soft metal tubing	60PT Series with thermoplastic tubing	
2"	1/8"	.030	1¼	-	400
3"	3/16"	.030	1¼	-	400
4"	1/4"	.030	1¼	2	300
5"	5/16"	.032	1¼	2	300
6"	3/8"	.032	2¼	2	200
8"	1/2"	.032	2¼	2	200
10"	5/8"	.035	2¼	2	150
12"	3/4"	.035	2¼	2	100
14"	7/8"	.035	2¼	-	75

**Male Connectors**

**Feature:**

- reference SAE 060102 BA

Tube Size	Pipe Thread	Brass Part #
1/8"	1/8"	68C-0202
3/16"	1/8"	68C-0302
	1/4"	68C-0304
1/4"	1/8"	68C-0402
	1/4"	68C-0404
	3/8"	68C-0406
5/16"	1/2"	68C-0408
	1/8"	68C-0502
	1/4"	68C-0504
3/8"	1/8"	68C-0602
	1/4"	68C-0604
	3/8"	68C-0606
	1/2"	68C-0608
7/16"	1/4"	68C-0704
1/2"	1/4"	68C-0804
	3/8"	68C-0806
	1/2"	68C-0808
5/8"	3/8"	68C-1006
	1/2"	68C-1008
	3/4"	68C-1012
3/4"	1/2"	68C-1208
	3/4"	68C-1212
7/8"	3/4"	68C-1412



Compression Fittings

Female Connectors

Feature:

- reference SAE 060103 BA



Tube Size	Pipe Thread	Brass Part #
1/8"	1/8"	<b>66C-0202</b>
3/16"	1/8"	<b>66C-0302</b>
	1/4"	<b>66C-0304</b>
1/4"	1/8"	<b>66C-0402</b>
	1/4"	<b>66C-0404</b>
5/16"	1/8"	<b>66C-0502</b>
	1/4"	<b>66C-0504</b>
3/8"	1/8"	<b>66C-0602</b>
	1/4"	<b>66C-0604</b>
	3/8"	<b>66C-0606</b>
	1/2"	<b>66C-0608</b>
1/2"	1/4"	<b>66C-0804</b>
	3/8"	<b>66C-0806</b>
	1/2"	<b>66C-0808</b>
5/8"	1/2"	<b>66C-1008</b>

Unions

Feature:

- reference SAE 060101 BA



Tube Size	Brass Part #
1/8"	<b>62C-02</b>
3/16"	<b>62C-03</b>
1/4"	<b>62C-04</b>
5/16"	<b>62C-05</b>
3/8"	<b>62C-06</b>
7/16"	<b>62C-07</b>
1/2"	<b>62C-08</b>
5/8"	<b>62C-10</b>
3/4"	<b>62C-12</b>
7/8"	<b>62C-14</b>

Union Reducers

Feature:

- reference SAE 060101 BA



Tube Size	Brass Part #
1/4" x 3/16"	<b>62C-0403</b>
3/8" x 1/4"	<b>62C-0604</b>
1/2" x 3/8"	<b>62C-0806</b>
5/8" x 3/8"	<b>62C-1006</b>

Bulkhead Unions



Tube Size	Brass Part #
1/4"	<b>62CBH-04</b>
3/8"	<b>62CBH-06</b>

Compression Fittings

Straight Through Tank Fittings

Tube Size	Pipe Thread	Brass Part #
3/16"	1/8"	682C-0302
3/8"	3/8"	682C-0606
1/2"	1/2"	682C-0808



Pipe, Welding & Tube Fittings

Female Elbows

Feature:

- reference SAE 060203 BA

Tube Size	Pipe Thread	Brass Part #
1/8"	1/8"	170C-0202
3/16"	1/8"	170C-0302
1/4"	1/8"	170C-0402
	1/4"	170C-0404
3/8"	1/4"	170C-0604
	3/8"	170C-0606
7/16"	1/4"	170C-0704
1/2"	3/8"	170C-0806



Male Elbows

Feature:

- reference SAE 060202 BA

Tube Size	Pipe Thread	Brass Part #
1/8"	1/8"	269C-0202
3/16"	1/8"	169C-0302
	1/4"	169C-0304
1/4"	1/8"	169C-0402
	1/4"	169C-0404
	3/8"	169C-0406
5/16"	1/8"	169C-0502
	1/4"	169C-0504
	3/8"	169C-0506
3/8"	1/8"	169C-0602
	1/4"	169C-0604
	3/8"	169C-0606
	1/2"	169C-0608
1/2"	1/4"	169C-0804
	3/8"	169C-0806
	1/2"	169C-0808
5/8"	1/2"	169C-1008
3/4"	1/2"	169C-1208
	3/4"	169C-1212



45° Elbows

Tube Size	Pipe Thread	Brass Part #
1/4"	1/8"	179C-0402
	1/4"	179C-0404
3/8"	1/8"	179C-0602
	1/4"	179C-0604
1/2"	3/8"	179C-0606
	3/8"	179C-0806



Compression Fittings

Union Elbows

Feature:

- reference SAE 060201 BA



Tube Size	Brass Part #
1/8"	165C-02
3/16"	165C-03
1/4"	165C-04
5/16"	165C-05
3/8"	165C-06
7/16"	165C-07
1/2"	165C-08
5/8"	165C-10
3/4"	165C-12

Male Branch Tees

Feature:

- reference SAE 060425 BA



Tube Size	Pipe Thread	Brass Part #
1/8"	1/8"	172C-0202
3/16"	1/8"	172C-0302
1/4"	1/8"	172C-0402
	1/4"	172C-0404
3/8"	1/8"	172C-0602
	1/4"	172C-0604
	3/8"	172C-0606
1/2"	3/8"	172C-0806

Female Branch Tee



Tube Size	Pipe Thread	Brass Part #
1/4"	1/8"	177C-0402

Union Tees

Feature:

- reference SAE 060401 BA



Tube Size 1 and 2	Tube Size 3	Brass Part #
1/8"	1/8"	164C-02
3/16"	3/16"	264C-03
1/4"	1/4"	164C-04
5/16"	5/16"	164C-05
3/8"	3/8"	164C-06
1/2"	1/2"	164C-08
5/8"	5/8"	164C-10
3/4"	3/4"	164C-12
3/8"	1/4"	164C-06-06-04
1/2"	3/8"	164C-08-08-06

Compression Fittings

Male Run Tees

Feature:

- reference SAE 060424 BA

Tube Size	Pipe Thread	Brass Part #
1/8"	1/8"	171C-0202
3/16"	1/8"	171C-0302
1/4"	1/8"	171C-0402
1/4"	1/4"	171C-0404
3/8"	1/4"	171C-0604



Pipe, Welding & Tube Fittings

Adapter Tee

Tube Size	Male Pipe Thread	Female Straight Thread	Brass Part #
1/4"	1/8"	7/16"-24	176C-0402



Seal Plug

Tube Size	Brass Part #
1/4"	639C-04



Inserts

Tube Size	Tube Wall Thickness	Brass Part #
1/8"	.016"	63PT-0216
	.023"	63PT-0223
3/16"	.025"	63PT-0325
	.040"	63PT-0340
1/4"	.040"	63PT-0440
	.062"	63PT-0462
5/16"	.040"	63PT-0540
	.062"	63PT-0562
3/8"	.062"	63PT-0662
1/2"	.062"	63PT-0862
5/8"	.062"	63PT-1062



- Acetal sleeves and brass inserts allow for standard compression fittings to be used with industrial grades of thermoplastic tubing.

Brass Sleeves

Feature:

- reference SAE 060115

Tube Size	Brass Part #
1/8"	60C-02
3/16"	60C-03
1/4"	60C-04
5/16"	60C-05
3/8"	60C-06
7/16"	60C-07
1/2"	60C-08
5/8"	60C-10
3/4"	60C-12
7/8"	60C-14



## Compression Fittings



## Acetal Sleeves

Tube Size	Acetal Part #
1/4"	<b>60PT-04</b>
5/16"	<b>60PT-05</b>
3/8"	<b>60PT-06</b>
1/2"	<b>60PT-08</b>
5/8"	<b>60PT-10</b>

- Acetal sleeves and brass inserts allow for standard compression fittings to be used with industrial grades of thermoplastic tubing.

## Nuts

## Feature:

- reference SAE 060110



Tube Size	Straight Thread	Brass Part #
1/8"	5/16"-24	<b>61C-02</b>
3/16"	3/8"-24	<b>61C-03</b>
1/4"	7/16"-24	<b>61C-04</b>
5/16"	1/2"-24	<b>61C-05</b>
3/8"	9/16"-24	<b>61C-06</b>
7/16"	5/8"-24	<b>61C-07</b>
1/2"	11/16"-20	<b>61C-08</b>
5/8"	13/16"-18	<b>61C-10</b>
3/4"	1"-18	<b>61C-12</b>
7/8"	1-1/8"-18	<b>61C-14</b>

## Long Nuts

## Feature:

- reference SAE 060111



Tube Size	Straight Thread	Brass Part #
1/4"	7/16"-24	<b>61CL-04</b>
5/16"	1/2"-24	<b>61CL-05</b>
3/8"	9/16"-24	<b>61CL-06</b>
1/2"	11/16"-20	<b>61CL-08</b>
5/8"	13/16"-18	<b>61CL-10</b>
3/4"	1"-18	<b>61CL-12</b>

## Brass SAE 45° Flare Fittings

**Applications:**

- for use with copper, brass, aluminum and welded steel hydraulic tubing that can be flared

**Features:**

- economical fitting
- resists mechanical pullout
- easy to disassemble and may be reassembled repeatedly, for a leak-proof connection
- manufactured from CA 360, CA 345, or CA377 brass
- for use with hard-to-hold liquids and gases
- Listed with Underwriter's Laboratories for flammable liquid, marine, refrigeration and gas applications. Meets functional requirements of SAE J512 and J513, ASA and MS (Military Standards).
- temperature range: **-65°F to 250°F (-54°C to 121°C)**

**Working Pressure Ranges:**

Temperature and type of tubing used are important factors, the following table is a general guide for proper selection. The PSI rating given is based on a temperature of **73°F (22°C)** using copper tubing.

PSI	Tube OD	Tube Wall
<b>1400</b>	1/4"	.030
<b>1000</b>	3/8"	.032
<b>750</b>	1/2"	.032
<b>650</b>	5/8"	.035
<b>550</b>	3/4"	.035

**Assembly Instructions:**

1. Cut tubing squarely and clean tube end thoroughly to remove burrs.
2. Place nut onto tube. Place threaded end of nut toward end of tube.
3. Flare tube end with flaring tool to provide 45° flare (flare tools are available, please contact Dixon® for pricing and availability).
4. Clamp tube flare between nut and nose of fitting body by screwing nut on finger-tight. Tighten with a wrench an additional 1/4 turn for a metal-to-metal seal.

### Male Connectors

**Feature:**

- reference SAE 010102

Tube Size	Pipe Size	Straight Thread	Hex	Brass Part #
1/4"	1/4"	7/16"-20	9/16"	<b>48F-4-4</b>
	3/8"	7/16"-20	11/16"	<b>48F-4-6</b>
	1/2"	7/16"-20	7/8"	<b>48F-4-8</b>
3/8"	1/8"	5/8"-18	5/8"	<b>48F-6-2</b>
	1/4"	5/8"-18	5/8"	<b>48F-6-4</b>
	3/8"	5/8"-18	11/16"	<b>48F-6-6</b>
	1/2"	5/8"-18	7/8"	<b>48F-6-8</b>
1/2"	1/4"	3/4"-16	3/4"	<b>48F-8-4</b>
	3/8"	3/4"-16	3/4"	<b>48F-8-6</b>
	1/2"	3/4"-16	7/8"	<b>48F-8-8</b>
5/8"	3/8"	7/8"-14	7/8"	<b>48F-10-6</b>
3/4"	3/4"	1-1/16"-14	1-1/16"	<b>48F-12-12</b>



### Female Connectors

**Feature:**

- reference SAE 010103

Tube Size	Pipe Size	Straight Thread	Hex	Brass Part #
1/4"	1/4"	7/16"-20	11/16"	<b>46F-4-4</b>
3/8"	1/4"	5/8"-18	11/16"	<b>46F-6-4</b>
	3/8"	5/8"-18	13/16"	<b>46F-6-6</b>
1/2"	1/2"	5/8"-18	1"	<b>46F-6-8</b>
	1/4"	3/4"-16	3/4"	<b>46F-8-4</b>
5/8"	3/8"	3/4"-16	13/16"	<b>46F-8-6</b>
	3/8"	7/8"-14	7/8"	<b>46F-10-6</b>



## Brass SAE 45° Flare Fittings

## Unions



## Feature:

- reference SAE 010101

Tube Size	Straight Thread	Hex	Brass Part #
1/4"	7/16"-20	7/16"	<b>42F-4</b>
3/8"	5/8"-18	5/8"	<b>42F-6</b>
1/2"	3/4"-16	3/4"	<b>42F-8</b>

## Male Elbows

## Feature:

- reference SAE 010202



Tube Size	Pipe Size	Straight Thread	Brass Part #
1/4"	1/8"	7/16"-20	<b>149F-4-2</b>
	1/4"	7/16"-20	<b>149F-4-4</b>
	3/8"	7/16"-20	<b>149F-4-6</b>
3/8"	1/4"	5/8"-18	<b>149F-6-4</b>
	3/8"	5/8"-18	<b>149F-6-6</b>
	1/2"	5/8"-18	<b>149F-6-8</b>
1/2"	1/4"	3/4"-16	<b>149F-8-4</b>
	3/8"	3/4"-16	<b>149F-8-6</b>
	1/2"	3/4"-16	<b>149F-8-8</b>
5/8"	1/2"	7/8"-14	<b>149F-10-8</b>
3/4"	3/4"	1-1/16"-14	<b>149F-12-12</b>

## Female Elbows

## Feature:

- reference SAE 010203



Tube Size	Pipe Size	Straight Thread	Brass Part #
1/4"	1/4"	7/16"-20	<b>150F-4-4</b>
3/8"	3/8"	5/8"-18	<b>150F-6-6</b>
3/8"	1/2"	5/8"-18	<b>150F-6-8</b>

## 90° Swivel Elbows



Tube Size	Straight Thread	Brass Part #
1/4"	7/16"-20	<b>166FSV-4-4</b>
3/8"	5/8"-18	<b>166FSV-6-6</b>
1/2"	3/4"-16	<b>166FSV-8-8</b>



Brass SAE 45° Flare Fittings

45° Elbows

Feature:

- reference SAE 010302

Tube Size	Pipe Size	Straight Thread	Brass Part #
1/4"	1/4"	7/16"-20	<b>159F-4-4</b>
3/8"	1/4"	5/8"-18	<b>159F-6-4</b>
	3/8"	5/8"-18	<b>159F-6-6</b>
1/2"	1/4"	3/4"-16	<b>159F-8-4</b>
	3/8"	3/4"-16	<b>159F-8-6</b>
	1/2"	3/4"-16	<b>159F-8-8</b>



Pipe, Welding & Tube Fittings

Union Tees

Feature:

- reference SAE 010401

Tube Size	Straight Thread	Brass Part #
1/4"	7/16"-20	<b>144F-4</b>
3/8"	5/8"-18	<b>144F-6</b>
1/2"	3/4"-16	<b>144F-8</b>

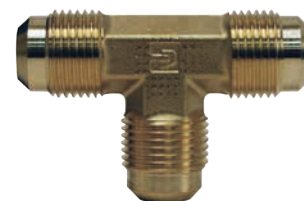

Short Nuts

Features:

- short nut for use when vibration is minimal
- reference SAE 010110

Tube Size	Straight Thread	Hex	Brass Part #
1/4"	7/16"-20	9/16"	<b>41FS-4</b>
3/8"	5/8"-18	3/4"	<b>41FS-6</b>
1/2"	3/4"-16	7/8"	<b>41FS-8</b>



Long Nuts

Features:

- long nut offers additional vibration capacity
- reference SAE 010111

Tube Size	Straight Thread	Hex	Brass Part #
1/4"	7/16"-20	9/16"	<b>41FL-4</b>
3/8"	5/8"-18	3/4"	<b>41FL-6</b>
1/2"	3/4"-16	7/8"	<b>41FL-8</b>



Flareless Bite Fittings

**Applications:**

- chemical, pulp and paper, oil and gas refineries, military, air compressors and machine tools
- well-suited for a variety of processing and general hydraulic applications

**Features:**

- Ideally suited for use with tubing having medium to extra heavy wall thicknesses.
- 3 piece design, with only one ferrule eliminates possible make-up errors that may occur using a twin ferrule tube fitting.
- Minimal risk of improper assembly as the ferrule visibly bites into the tubing, allowing installer to visually inspect the bite quality.
- fittings are suitable for sub-zero through elevated temperature applications
- temperature rating is limited by the material chosen
- pressure ratings are determined by the size (OD) and wall thickness (inches/mm) of the tubing on which they are to be installed

**Specifications:**

- exceeds Military (MIL F18866) and SAE J514 standards

**Assembly Instructions:**

- cut, de-burr and clean tubing
- pre-set ferrule onto tubing
- inspect ferrule bite in tubing by disassembling the fitting and visually inspecting the de-burred end of tube for slight indentation
- finger tighten nut and then further wrench tighten nut another 1/3 to 1/2 turn



Male Tube x Male NPTF Adapters

Tube OD	Male NPTF	Steel Part #
1/8"	1/8"	<b>FLC2404-02</b>
	1/4"	<b>FLC2404-02-04</b>
3/16"	1/8"	<b>FLC2404-03-02</b>
	1/4"	<b>FLC2404-04-02</b>
1/4"	1/4"	<b>FLC2404-04</b>
	3/8"	<b>FLC2404-04-06</b>
	1/2"	<b>FLC2404-04-08</b>
5/16"	1/8"	<b>FLC2404-05-02</b>
	1/4"	<b>FLC2404-05-04</b>
3/8"	1/8"	<b>FLC2404-06-02</b>
	1/4"	<b>FLC2404-06-04</b>
	3/8"	<b>FLC2404-06</b>
1/2"	1/2"	<b>FLC2404-06-08</b>
	3/4"	<b>FLC2404-08-04</b>
	1"	<b>FLC2404-08-06</b>
5/8"	1 1/2"	<b>FLC2404-08</b>
	3/4"	<b>FLC2404-08-12</b>
	1"	<b>FLC2404-10-06</b>
3/4"	3/8"	<b>FLC2404-10-08</b>
	1/2"	<b>FLC2404-10-12</b>
	3/4"	<b>FLC2404-12-08</b>
1"	1"	<b>FLC2404-12</b>
	1 1/4"	<b>FLC2404-12-16</b>
	3/4"	<b>FLC2404-16-12</b>
1-1/4"	1"	<b>FLC2404-16</b>
	1-1/4"	<b>FLC2404-16-20</b>
1-1/2"	3/4"	<b>FLC2404-20-12</b>
	1-1/4"	<b>FLC2404-20</b>
1-1/2"	1-1/2"	<b>FLC2404-24</b>



Male Tube x Male 37° JIC

Tube OD	Male 37° JIC	Steel Part #
1/4"	1/4"	<b>FLC2402-04-04</b>
3/8"	3/8"	<b>FLC2402-06-06</b>
1/2"	1/2"	<b>FLC2402-08-08</b>
3/4"	3/4"	<b>FLC2402-12-12</b>

Male Tube x Female NPTF Adapters

Tube OD	Female NPTF	Steel Part #
1/8"	1/8"	FLC2405-02
1/4"	1/8"	FLC2405-04-02
	1/4"	FLC2405-04
5/16"	1/8"	FLC2405-05-02
	1/4"	FLC2405-06-04
3/8"	3/8"	FLC2405-06
	1/2"	FLC2405-08-04
1/2"	3/8"	FLC2405-08-06
	1/2"	FLC2405-08
5/8"	1/2"	FLC2405-10-08
3/4"	3/4"	FLC2405-12
1"	1"	FLC2405-16
1-1/4"	1 1/4"	FLC2405-20

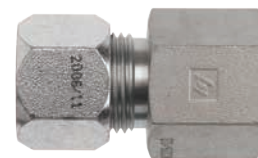

Pipe, Welding & Tube Fittings

Tube Unions

Tube OD	Steel Part #
1/8"	FLC2403-02
3/16"	FLC2403-03
1/4"	FLC2403-04
5/16"	FLC2403-05
3/8"	FLC2403-06
1/2"	FLC2403-08
5/8"	FLC2403-10
3/4"	FLC2403-12
1"	FLC2403-16
1-1/4"	FLC2403-20
1-1/2"	FLC2403-24



Male Tube x Male NPTF Adapter 90° Elbows

Tube OD	Male NPTF	Steel Part #
1/8"	1/8"	FLC2501-02
3/16"	1/8"	FLC2501-03-02
	1/4"	FLC2501-04-02
1/4"	3/8"	FLC2501-04-06
	1/2"	FLC2501-06-08
5/16"	1/8"	FLC2501-05-02
	1/4"	FLC2501-05-04
3/8"	1/8"	FLC2501-06-02
	1/4"	FLC2501-06-04
1/2"	3/8"	FLC2501-08-06
	1/2"	FLC2501-08
5/8"	3/4"	FLC2501-08-12
	1"	FLC2501-16-12
3/4"	1/2"	FLC2501-12-08
	3/4"	FLC2501-12
1"	3/4"	FLC2501-16-12
	1"	FLC2501-16
1 1/4"	1 1/4"	FLC2501-20
1 1/2"	1 1/2"	FLC2501-24

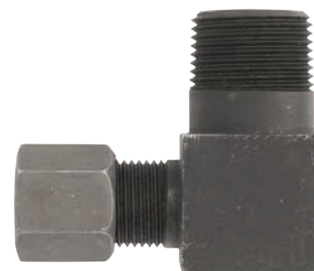



Male Union 90° Elbows

Tube OD	Steel Part #
1/4"	FLC2500-04
5/16"	FLC2500-05
3/8"	FLC2500-06
1/2"	FLC2500-08
5/8"	FLC2500-10
3/4"	FLC2500-12
1"	FLC2500-16
1-1/4"	FLC2500-20

Male Tube Union Tees

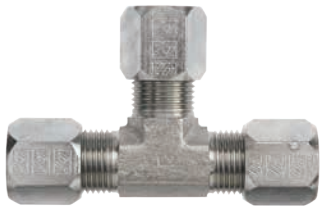

Tube OD	Steel Part #
1/8"	FLC2603-02
3/16"	FLC2603-03
1/4"	FLC2603-04
5/16"	FLC2603-05
3/8"	FLC2603-06
1/2"	FLC2603-08
5/8"	FLC2603-10
3/4"	FLC2603-12
1"	FLC2603-16
1-1/4"	FLC2603-20

Ferrules



Tube OD	Steel Part #
1/8"	FLC0319-02
3/16"	FLC0319-03
1/4"	FLC0319-04
5/16"	FLC0319-05
3/8"	FLC0319-06
1/2"	FLC0319-08
5/8"	FLC0319-10
3/4"	FLC0319-12
1"	FLC0319-16
1-1/4"	FLC0319-20
1-1/2"	FLC0319-24

Nuts



Tube OD	Steel Part #
1/8"	FLC0318-02
3/16"	FLC0318-03
1/4"	FLC0318-04
5/16"	FLC0318-05
3/8"	FLC0318-06
1/2"	FLC0318-08
5/8"	FLC0318-10
3/4"	FLC0318-12
1"	FLC0318-16
1-1/4"	FLC0318-20
1-1/2"	FLC0318-24

## Sharkbite® Push to Connect Fittings

**Applications:**

- for **water, dry, clean air** or **100% glycol solutions** only
- connects copper, CPVC, and PEX pipe in any combination
- approved for use underground and behind walls without access panels



**Features:**

- no soldering, clamps, unions or glue needed
- pressure rating: **200 PSI at 200°F (93°C)**
- integral tube liner for PEX installations
- Fittings can be rotated after assembly for easier installation in tight spaces.
- easy to disconnect if needed
- design certified and listed to ASSE 1061/NSF 61
- listed by IAPMO
- meets UPC, IPC and cUPC requirements
- all Sharkbite® fittings are lead free

Pipe, Welding & Tube Fittings

### Straight Couplings

Tube Size	Forged Brass Part #
1/2" x 1/2"	<b>U008</b>
3/4" x 3/4"	<b>U016</b>
1" x 1"	<b>U020</b>



### Reducing Couplings

Tube Size	Forged Brass Part #
3/4" x 1/2"	<b>U058</b>
1" x 3/4"	<b>U060</b>



### Straight Connectors

Tube Size	Female NPT	Forged Brass Part #
1/2"	1/2"	<b>U072</b>
3/4"	3/4"	<b>U088</b>
1"	1"	<b>U094</b>



Tube Size	Male NPT	Forged Brass Part #
1/2"	1/2"	<b>U120</b>
3/4"	3/4"	<b>U134</b>
1"	1"	<b>U140</b>



### Reducing Connectors

Tube Size	Female NPT	Forged Brass Part #
1/2"	3/4"	<b>U068</b>



Tube Size	Male NPT	Forged Brass Part #
1/2"	3/4"	<b>U116</b>



Sharkbite® Push to Connect Fittings

Pipe, Welding & Tube Fittings



Elbows

Tube Size	Forged Brass Part #
1/2" x 1/2"	<b>U248</b>
3/4" x 3/4"	<b>U256</b>
1" x 1"	<b>U260</b>

Drop Ear Elbow



Tube Size	Female NPT	Forged Brass Part #
1/2"	1/2"	<b>U334</b>

Tees



Tube Size	Forged Brass Part #
1/2"	<b>U362</b>
3/4"	<b>U370</b>

Reducing Tee



Tube Size (2)	Tube Size	Forged Brass Part #
3/4"	1/2"	<b>U412</b>

End Stops



Tube Size	Forged Brass Part #
1/2"	<b>U514</b>
3/4"	<b>U518</b>
1"	<b>U520</b>

Slip Couplings



Application:

- for use with copper pipe only



Tube Size	Forged Brass Part #
1/2"	<b>U3008</b>
3/4"	<b>U3016</b>

Disconnect Clips





Size	ABS Plastic Part #
1/2"	<b>U710</b>
3/4"	<b>U712</b>
1"	<b>U714</b>

**LIQUIfit™** Fittings

**Application:**

- Suitable for water, potable liquids and neutral gas applications: including water filtration, water coolers, coffee machines and beverage dispensers.

**Features:**

- EPDM seal secures connection with larger surface area than standard O-rings
- engineered polymer allows superior mechanical strength and chemical resistance
- full stainless gripping ring eliminates the need for locking clips
- release button protects and supports tubing
- FDA compliant
- meets California and Vermont <0.25% lead requirements
- NSF-51 listed for contact with food
- NSF-61 list C-Hot rated
- in compliance with the following standards:   

**Specifications:**

- working pressure:
  - 1/4" **230 PSI** from 35°F to 100°F (1.7°C to 38°C)  
**150 PSI** at 150°F (66°C)  
**60 PSI** at 200°F (93°C)
  - 3/8" **190 PSI** from 35°F to 100°F (1.7°C to 38°C)  
**100 PSI** at 150°F (66°C)  
**60 PSI** at 200°F (93°C)
  - 1/2" **160 PSI** from 35°F to 100°F (1.7°C to 38°C)  
**100 PSI** at 150°F (66°C)  
**60 PSI** at 200°F (93°C)
- maximum torque values for NPTF threads:
  - 1/8" and 1/4" 1.0 ft. lbs. / 1.5Nm
  - 3/8" and 1/2" 2.2 ft. lbs. / 3.0Nm

**Male Connectors**

Tube OD	Male NPTF	Nylon Part #	Pkg Qty
1/4"	1/8"	<b>65055611WP2</b>	10
	1/4"	<b>65055614WP2</b>	10
3/8"	1/4"	<b>65056014WP2</b>	10
	3/8"	<b>65056018WP2</b>	10
1/2"	3/8"	<b>65056218WP2</b>	5
	1/2"	<b>65056222WP2</b>	5



**Female Connectors**

Tube OD	Female NPTF	Nylon Part #	Pkg Qty
1/4"	1/4"	<b>63155614WP2</b>	10
3/8"	3/8"	<b>63156018WP2</b>	10



**Faucet Connectors**

Tube OD	Female UNS	Nylon Part #	Pkg Qty
1/4"	7/16-24	<b>632556133WP2</b>	10
3/8"	7/16-24	<b>632560133WP2</b>	10



**Fixed Elbows**

Tube OD	Male NPTF	Nylon Part #	Pkg Qty
1/4"	1/8"	<b>65795611WP2</b>	10
	1/4"	<b>65795614WP2</b>	10
	3/8"	<b>65795618WP2</b>	10
3/8"	1/4"	<b>65796014WP2</b>	10
	3/8"	<b>65796018WP2</b>	10



**LIQUIfit™** Fittings

**Union Elbows**

Pipe, Welding  
& Tube Fittings



Tube OD	Nylon Part #	Pkg Qty
1/4"	<b>63025600WP2</b>	10
3/8"	<b>63026000WP2</b>	10
1/2"	<b>63026200WP2</b>	5

**Union Tees**



Tube OD	Nylon Part #	Pkg Qty
1/4"	<b>63045600WP2</b>	10
3/8"	<b>63046000WP2</b>	10
1/2"	<b>63046200WP2</b>	5

**Union Connectors**



Tube OD 1	Tube OD 2	Nylon Part #	Pkg Qty
1/4"	1/4"	<b>63065600WP2</b>	10
	3/8"	<b>63065660WP2</b>	10
3/8"	3/8"	<b>63066000WP2</b>	10
	1/2"	<b>63066062WP2</b>	5
1/2"	1/2"	<b>63066200WP2</b>	5

**Unequal Union Tee**



Branch Tube OD (1)	Run Tube OD (2)	Nylon Part #	Pkg Qty
1/4"	3/8"	<b>63046056WP2</b>	10

**Bulkhead Unions**



Tube OD	Nylon Part #	Pkg Qty
1/4"	<b>63165600WP2</b>	10
3/8"	<b>63166000WP2</b>	10
1/2"	<b>63166200WP2</b>	5

**Union Y Connectors**



Tube OD	Nylon Part #	Pkg Qty
1/4"	<b>63405600WP2</b>	10
3/8"	<b>63406000WP2</b>	10
1/2"	<b>63406200WP2</b>	5



**LIQUIfit™** Fittings

**Swivel Elbows**

Tube OD	Male NPTF	Nylon Part #	Pkg Qty
1/4"	1/8"	<b>65095611WP2</b>	10
	1/4"	<b>65095614WP2</b>	10
	3/8"	<b>65095618WP2</b>	10
3/8"	1/4"	<b>65096014WP2</b>	10
	3/8"	<b>65096018WP2</b>	10
1/2"	3/8"	<b>65096218WP2</b>	4
	1/2"	<b>65096222WP2</b>	4



Pipe, Welding & Tube Fittings

**Swivel Branch Tees**

Tube OD	Male NPTF	Nylon Part #	Pkg Qty
1/4"	1/8"	<b>65085611WP2</b>	10
	1/4"	<b>65085614WP2</b>	10
	3/8"	<b>65085618WP2</b>	10
3/8"	1/4"	<b>65086014WP2</b>	10
	3/8"	<b>65086018WP2</b>	10



**Swivel Male Run Tees**

Tube OD	Male NPTF	Nylon Part #	Pkg Qty
1/4"	1/8"	<b>65035611WP2</b>	10
	1/4"	<b>65035614WP2</b>	10
	3/8"	<b>65035618WP2</b>	10
3/8"	1/4"	<b>65036014WP2</b>	10
	3/8"	<b>65036018WP2</b>	10



**Stem Adapters**

Tube OD	Male NPTF	Nylon Part #	Pkg Qty
1/4"	1/4"	<b>65215614WP2</b>	10
	3/8"	<b>65215618WP2</b>	10
3/8"	1/4"	<b>65216014WP2</b>	10
	3/8"	<b>65216018WP2</b>	10
1/2"	3/8"	<b>65216218WP2</b>	5
	1/2"	<b>65216222WP2</b>	5



K

**End Stops**

Tube OD	Nylon Part #	Pkg Qty
1/4"	<b>63515600WP2</b>	10
3/8"	<b>63516000WP2</b>	10



**Plugs**

Tube OD	Nylon Part #	Pkg Qty
1/4"	<b>63265600WP2</b>	10
3/8"	<b>63266000WP2</b>	10
1/2"	<b>63266200WP2</b>	5



## LIQUIfit™ Fittings

## Hose Stems



Tube OD	Stem	Nylon Part #	Pkg Qty
1/4"	1/4"	<b>63225656WP2</b>	10
3/8"	1/4"	<b>63226056WP2</b>	10
	5/16"	<b>63226008WP2</b>	10
1/2"	3/8"	<b>63226060WP2</b>	10
	3/8"	<b>63226260WP2</b>	10

## Plug-in Reducers



Tube OD	Plug-in	Nylon Part #	Pkg Qty
1/4"	5/16"	<b>63665608WP2</b>	10
1/4"	3/8"	<b>63665660WP2</b>	10
3/8"	1/2"	<b>63666062WP2</b>	5

## Plug-in Elbows



Tube OD	Plug-in	Nylon Part #	Pkg Qty
1/4"	1/4"	<b>63825600WP2</b>	10
3/8"	3/8"	<b>63826000WP2</b>	10
1/2"	1/2"	<b>63826200WP2</b>	5

## Plug-in Tees



Tube OD	Plug-in	Nylon Part #	Pkg Qty
1/4"	1/4"	<b>63885600WP2</b>	10
3/8"	3/8"	<b>63886000WP2</b>	10
1/2"	1/2"	<b>63886200WP2</b>	5

TrueSeal™ Ball Valves

**Application:**

These corrosion resistant, all-plastic designed ball valves are ideal for water filtration units, coffee and beverage machines and a wide variety of other fluid applications.

**Features:**

- EPDM seal secures connection with larger surface area than standard O-rings
- full flow self-cleaning ball
- high-temperature, scale resistant Polysulfone ball
- glass-reinforced Polypropylene body
- FDA compliant
- NSF-51 listed for contact with food
- certified to NSF-61

**Specifications:**

- temperature range: **0°F to 225°F (-18°C to 107°C)**
- O-ring seal material: EPDM
- maximum operating pressure: **150 PSI**
- Burst pressure **600 PSI**
- Actual working pressures will be lower at elevated temperatures.

**Tube to Male NPTF**

Tube OD	Male NPTF	Polypropylene Part #	Pkg Qty
1/4"	1/4"	<b>PP4VMC4-MG</b>	10
	3/8"	<b>PP4VMC6-MG</b>	10
3/8"	1/4"	<b>PP6VMC4-MG</b>	10
	3/8"	<b>PP6VMC6-MG</b>	10



**Tube to Female NPTF**

Tube OD	Female NPTF	Polypropylene Part #	Pkg Qty
1/4"	1/8"	<b>PP4VFC2-MG</b>	10
	1/4"	<b>PP4VFC4-MG</b>	10
	3/8"	<b>PP4VFC6-MG</b>	10
3/8"	1/8"	<b>PP6VFC2-MG</b>	10
	1/4"	<b>PP6VFC4-MG</b>	10
	3/8"	<b>PP6VFC6-MG</b>	10



**Tube to Male NPTF Elbows**

Tube OD	Male NPTF	Polypropylene Part #	Pkg Qty
1/4"	1/4"	<b>PP4VME4-MG</b>	10
	3/8"	<b>PP4VME6-MG</b>	10
	1/2"	<b>PP4VME8-MG</b>	10
3/8"	1/4"	<b>PP6VME4-MG</b>	10
	3/8"	<b>PP6VME6-MG</b>	10
	1/2"	<b>PP6VME8-MG</b>	10



**Tube to Female NPTF Elbows**

Tube OD	Female NPTF	Polypropylene Part #	Pkg Qty
1/4"	1/4"	<b>PP4VFE4-MG</b>	10
	3/8"	<b>PP4VFE6-MG</b>	10
3/8"	1/4"	<b>PP6VFE4-MG</b>	10
	3/8"	<b>PP6VFE6-MG</b>	10



TrueSeal™ Ball Valves

Pipe, Welding & Tube Fittings

Tube to Tube Unions



Tube OD 1	Tube OD 2	Polypropylene Part #	Pkg Qty
1/4"	1/4"	<b>PP4VUC4-MG</b>	10
3/8"	1/4"	<b>PP4VUC6-MG</b>	10
3/8"	3/8"	<b>PP6VUC6-MG</b>	10

Tube to Tube Elbow Unions



Tube OD 1	Tube OD 2	Polypropylene Part #	Pkg Qty
1/4"	1/4"	<b>PP4VEU4-MG</b>	10
	3/8"	<b>PP4VEU6-MG</b>	10
3/8"	1/4"	<b>PP6VEU4-MG</b>	10
	3/8"	<b>PP6VEU6-MG</b>	10

Tube to Plug-in Elbow Unions



Tube OD	Stem	Polypropylene Part #	Pkg Qty
1/4"	3/8"	<b>PP4VTEU6-MG</b>	10
3/8"	3/8"	<b>PP6VTEU6-MG</b>	10

TrueSeal™ Check Valves

Application:

Push-to connect check valves ensure protection against reversal of flow. The valves have an arrow molded into the body to indicate the direction of flow. Valves are designed for connection with either thermoplastic or soft metal tubing and are intended for use with liquids only.



Features:

- body material: acetal
- O-ring: EPDM
- metal grip edge: 300 stainless steel
- NSF-51 listed
- maximum operating pressure: **150 PSI** (dependent on tubing used)
- temperature range: **34°F to 150°F (1°C to 65°C)**
- cracking pressure: 1/3 PSI



Tube OD	Acetal Part #	Pkg Qty
1/4"	<b>A4VC4-MG</b>	25
3/8"	<b>A6VC6-MG</b>	25

<b>Fire Hose</b> .....	<b>732 to 739</b>	<b>Nozzles (cont.)</b> .....	<b>752 to 765</b>
300# single jacket all polyester.....	732	Break apart attack .....	761
500# single jacket all polyester.....	733 , 734	Pistol grip adapters.....	761
UL labeled.....	733	Gallonge .....	762
Color impregnated .....	734	Penetrator.....	764
800# double jacket all polyester .....	734	Straight steam .....	764
Color impregnated .....	734	Adjust-A-Power.....	765
MSHA approved single jacket mine.....	735	Constant Flow.....	765
Double jacket potable water hose .....	735		
500# all polyester rack.....	735, 736	<b>Adapters &amp; Connections ...</b>	<b>766 to 819</b>
UL labeled.....	735	Double hex .....	766, 782 to 784
Non-UL labeled .....	736	Swivel .....	767 to 770, 779
500# nitrile covered .....	736	Hydrant.....	771 to 774, 785, 786
Forestry non-weeping.....	737	Hazmat .....	773
Forestry mop up .....	737	Hex nipples.....	774 to 776
Forestry mop up kit.....	737	Style N37 .....	777, 778
Nitrile covered - heavy duty .....	738	Suction.....	780, 803
Non-collapsible .....	739	Style N54 .....	781
Chemical booster .....	739	Style N36.....	785
Fire and utility.....	739	Caps & plugs .....	787 to 792
		Replacement swivels & accessories .....	792
<b>Fire Hose Couplings</b> .....	<b>740 to 743</b>	Storz .....	793 to 797
Expansion ring couplings.....	740 to 742	Accessories.....	798
Washers.....	741 to 742	Wrenches .....	799 to 802
Ring and gasket guide .....	742	Continuous swivel.....	803
Hose type booster couplings .....	743	Pump head testers .....	804
Forestry couplings .....	743	Manifolds .....	804
		Roof connections.....	805 to 807
<b>Racks, Reels, Hose cabinet</b> .....	<b>744 to 750</b>	Siamese connections .....	808 to 811
Style V Swing type hose storage.....	744	Wall hydrant body.....	812
Swing type hose storage .....	745	Snoots .....	813, 814
Heavy duty swing type hose storage.....	745	Wall plates .....	814
Global continuous flow .....	746	Siamese assemblies.....	815
Continuous flow .....	747	Single sprinkler connection.....	816
Hump racks .....	748	Single inlet and hydrant connections.....	816
Hose racks .....	748	Wall hydrants.....	816
Pin rack hose assembly .....	749	Round ID plates.....	817
Semi automatic pin racks .....	749	British Instantaneous.....	818, 819
Steel hose cabinet .....	750	International shore.....	819
		Pressure temperature rating.....	820
<b>Hose protection</b> .....	<b>751</b>	<b>Accessories</b> .....	<b>820</b>
Fire jacket.....	751	<b>Valves</b> .....	<b>821 to 842</b>
Fire tape .....	751	<b>Specialty products</b> .....	<b>843</b>
<b>Nozzles</b> .....	<b>752 to 765</b>		
Fog .....	752, 753, 758, 759, 760, 762, 763		
Rack .....	753		
Ball shutoffs .....	754, 761, 763, 764		
Nozzle tips.....	754		
Plain hose.....	754, 755		
Twist .....	754		
Red plain hose.....	755		
UL play pipes.....	755		
Street cleaning.....	755		
US Coast Guard approved .....	756		
Monitors & nozzles .....	757		
Garden hose.....	760		

Garden hose and washdown hoses can be found on pages 883 - 885.

## 300# Single Jacket All Polyester Fire Hose

**Features:**

- outer construction: single jacket, all polyester
- tube construction: EPDM rubber lining
- proof pressure: **300 PSI**
- service test pressure: **150 PSI** at ambient temperature **70°F (21°C)**
- working pressure: **135 PSI** at ambient temperature **70°F (21°C)**
- 25' and 75' lengths, UL labeled hoses and other threads and configurations are available, contact Dixon®

Fire Fittings & Accessories



**Uncoupled**

Size	Bowl	Length	Part #
1½"	1-3/4"	50'	<b>A315-50UC</b>
	1-3/4"	100'	<b>A315-100UC</b>
2"	2-1/4"	50'	<b>A320-50UC</b>
	2-1/4"	100'	<b>A320-100UC</b>
2½"	2-13/16"	50'	<b>A325-50UC</b>
	2-13/16"	100'	<b>A325-100UC</b>
3"	3-3/8"	50'	<b>A330-50UC</b>
	3-3/8"	100'	<b>A330-100UC</b>

**Coupled with female and male expansion ring couplings**



Size	Length	Rocker Lug Aluminum NST (NH)	Rocker Lug Brass NST (NH)	Rocker Lug Aluminum NPSH
		Part #	Part #	Part #
1½"	50'	<b>A315-50RAF</b>	<b>A315-50RBF</b>	<b>A315-50RAS</b>
	100'	<b>A315100RAF</b>	<b>A315100RBF</b>	<b>A315100RAS</b>
2"	50"	---	---	<b>A320-50RAS</b>
	100'	---	---	<b>A320100RAS</b>
2½"	50'	<b>A325-50RAF</b>	<b>A325-50RBF</b>	<b>A325-50RAS</b>
	100'	<b>A325100RAF</b>	<b>A325100RBF</b>	<b>A325100RAS</b>
3"	50'	---	---	<b>A330-50RAS</b>
	100'	---	---	<b>A330100RAS</b>

500# Single Jacket All Polyester Fire Hose

Features:

- outer construction: single jacket, all polyester
- tube construction: EPDM rubber lining
- proof pressure: **500 PSI**
- service test pressure: **250 PSI** at ambient temperature **70°F (21°C)**
- working pressure: **225 PSI** at ambient temperature **70°F (21°C)**
- other threads and configurations are available, contact Dixon®

Uncoupled

Size	Bowl	Length	Part #
1"	1-1/4"	50'	<b>A510-50UC</b>
	1-1/4"	100'	<b>A510-100UC</b>
1½"	1-3/4"	50'	<b>A515-50UC</b>
	1-3/4"	100'	<b>A515-100UC</b>
2½"	2-13/16"	50'	<b>A525-50UC</b>
	2-13/16"	100'	<b>A525-100UC</b>



Coupled with female and male expansion ring couplings

Size	Length	Rocker Lug Aluminum NST (NH) Part #	Rocker Lug Brass NST (NH) Part #	Rocker Lug Aluminum NPSH Part #
1"	50'	<b>A510-50RAF</b>	---	<b>A510-50RAS</b>
	100'	<b>A510100RAF</b>	---	<b>A510100RAS</b>
1½"	25'	<b>A515-25RAF</b>	---	<b>A515-25RAS</b>
	50'	<b>A515-50RAF</b>	<b>A515-50RBF</b>	<b>A515-50RAS</b>
	75'	<b>A515-75RAF</b>	---	<b>A515-75RAS</b>
	100'	<b>A515100RAF</b>	<b>A515100RBF</b>	<b>A515100RAS</b>
2½"	25'	<b>A525-25RAF</b>	---	<b>A525-25RAS</b>
	50'	<b>A525-50RAF</b>	<b>A525-50RBF</b>	<b>A525-50RAS</b>
	75'	<b>A525-75RAF</b>	---	---
	100'	<b>A525100RAF</b>	<b>A525100RBF</b>	<b>A525100RAS</b>



500# Single Jacket Fire Hose - UL labeled



Coupled with female and male expansion ring couplings

Features:

- outer construction: single jacket, all polyester
- tube construction: EPDM rubber lining
- proof pressure: **500 PSI**
- service test pressure: **250 PSI** at ambient temperature **70°F (21°C)**
- working pressure: **225 PSI** at ambient temperature **70°F (21°C)**
- Underwriters Listed
- impregnated hose and other lengths threads and configurations are available, contact Dixon®

Size	Coupling Type	Length	NST Thread Part #
1½"	combo lug, brass	50'	<b>A515U50CBF</b>
2½"	combo lug, brass	50	<b>A525U50CBF</b>



500# Single Jacket Fire Hose - Color Impregnated

Fire Fittings & Accessories



orange



red

Features:

- outer construction: single jacket, all polyester
- tube construction: EPDM rubber lining
- proof pressure: **500 PSI**
- service test pressure: **250 PSI**
- working pressure: **225 PSI** at ambient temperature **70°F (21°C)**
- consult Dixon® for pricing and availability of other colors, lengths, threads and configurations

Coupled with female and male expansion ring couplings

Size	Coupling Type	Length	Color	Part #
1½"	rocker lug, aluminum, NST (NH)	50'	yellow	<b>A515Y50RAF</b>
	rocker lug, aluminum, NPSH	50'	yellow	<b>A515Y50RAS</b>
	rocker lug, aluminum, NST (NH)	50'	red	<b>A515R50RAF</b>
	rocker lug, aluminum, NPSH	50'	red	<b>A515R50RAS</b>
	rocker lug, aluminum, NST (NH)	50'	orange	<b>A515OR50RAF</b>
	rocker lug, aluminum, NPSH	50'	orange	<b>A515OR50RAS</b>

800# Double Jacket All Polyester Fire Hose

Features:

- outer construction: double jacket, all polyester
- tube construction: EPDM rubber lining
- proof pressure: **800 PSI**
- service test pressure: **400 PSI**
- working pressure: **360 PSI** at ambient temperature **70°F (21°C)**
- consult Dixon™ for pricing and availability of 75' lengths and other threads and configurations

Coupled with female and male expansion ring couplings



Size	Length	Rocker Lug Aluminum NST (NH) RAF	Rocker Lug Brass NST (NH) RBF	Rocker Lug Aluminum NPSH RAS
1½"	25'	<b>D815-25RAF</b>	---	---
	50'	<b>D815-50RAF</b>	<b>D815-50RBF</b>	<b>D815-50RAS</b>
	100'	<b>D815100RAF</b>	<b>D815100RBF</b>	<b>D815100RAS</b>
2½"	25'	<b>D825-25RAF</b>	---	---
	50'	<b>D825-50RAF</b>	<b>D825-50RBF</b>	<b>D825-50RAS</b>
	100'	<b>D825100RAF</b>	<b>D825100RBF</b>	<b>D825100RAS</b>

800# Double Jacket Fire Hose - Color Impregnated

Features:

- outer construction: double jacket, all polyester
- tube construction: black, synthetic rubber liner
- proof pressure: **800 PSI** at **70°F (21°C)**
- service test pressure: **400 PSI** at **70°F (21°C)**
- working pressure: **360 PSI** at **70°F (21°C)**
- other lengths, threads and couplings and colors (yellow, red, blue, tan, orange, green, black) are available, contact Dixon®

Coupled with female & male expansion ring couplings



Size	Thread NH (NST)	Coupling Type	Length	Part #
1½"	1½"	rocker lug, aluminum NST (NH)	50'	<b>D815Y50RAF</b>
		rocker lug, aluminum NST (NH)	100'	<b>D815Y100RAF</b>
		rocker lug, aluminum NPSH	50'	<b>D815Y50RAS</b>
		rocker lug, aluminum NPSH	100'	<b>D815Y100RAS</b>
1¾"	1½"	rocker lug, aluminum NST (NH)	50'	<b>D817Y50RAF</b>
2½"	2½"	rocker lug, aluminum NST (NH)	50'	<b>D825Y50RAF</b>
		rocker lug, aluminum NST (NH)	100'	<b>D825Y100RAF</b>
3"	2½"	rocker lug, aluminum NST (NH)	50'	<b>D8325Y50RAF</b>



## MSHA Approved Single Jacket Mine Fire Hose Coupled with female and male aluminum rocker lug expansion ring couplings

**Specification:**

- approved by MSHA: Mine Safety and Health Administration for all mine fire protection applications

**Features:**

- outer construction: single jacket, synthetic flame resistant
- tube construction: flame resistant lining
- proof pressure: **500 PSI at 70°F (21°C)**
- service test pressure: **250 PSI at 70°F (21°C)**
- working pressure: **225 PSI at 70°F (21°C)**



Size	Thread	Length	Part #
1½"	NST (NH)	50'	<b>SM515W50RAF</b>
	NPSH	50'	<b>SM515W50RAS</b>

## Double Jacket Potable Water Hose - Blue

**Features:**

- Liner is NSF approved for potable water, fittings are not, except for temporary / emergency drinking needs only.
- outer construction: double jacket, all polyester
- tube construction: thermoplastic
- proof pressure: **600 PSI at 70°F (21°C)**
- service test pressure: **300 PSI at 70°F (21°C)**
- working pressure: **270 PSI at 70°F (21°C)**



**Coupled with female and male, brass or aluminum rocker lug, expansion ring couplings**

Size	Thread	Length	Brass Expansion Ring Part #	Aluminum Expansion Ring Part #
1½"	NPSH	50'	<b>PW615B50RBS</b>	<b>PW615B50RAS</b>
	NPSH	100'	<b>PW615B100RBS</b>	<b>PW615B100RAS</b>
	NST (NH)	50'	<b>PW615B50RBF</b>	<b>PW615B50RAF</b>
	NST (NH)	100'	<b>PW615B100RBF</b>	<b>PW615B100RAF</b>
2½"	NPSH	50'	<b>PW625B50RBS</b>	<b>PW625B50RAS</b>
	NPSH	100'	<b>PW625B100RBS</b>	<b>PW625B100RAS</b>
	NST (NH)	50'	<b>PW625B50RBF</b>	<b>PW625B50RAF</b>
	NST (NH)	100'	<b>PW625B100RBF</b>	<b>PW625B100RAF</b>

## 500# All Polyester Rack Hose - UL Labeled

**Application:**

- for pin rack service / emergency fire fighting only, not to be used for washdown

**Features:**

- outer construction: single jacket, all polyester
- tube construction: clear thermoplastic
- proof pressure: **300 PSI at ambient temperature 70°F (21°C)**
- service test pressure: **150 PSI at ambient temperature 70°F (21°C)**
- working pressure: **135 PSI at ambient temperature 70°F (21°C)**
- Underwriters Listed



**Coupled with female and male expansion ring couplings**

Size	Coupling Type	Length	Folded Part #	Coiled Part #
1½"	combo lug, brass NST (NH)	50'	<b>R515U50CBF/F</b>	<b>R515U50CBF</b>
	combo lug, brass NST (NH)	100'	<b>R515U100CBF/F</b>	<b>R515U100CBF</b>
	combo lug, alum. NST (NH)	50'	<b>R515U50RAF/F</b>	<b>R515U50RAF</b>
	combo lug, alum. NST (NH)	100'	<b>R515U100RAF/F</b>	---

500# All Polyester Rack Hose - non-UL Labeled

Fire Fittings & Accessories



**Application:**

- for pin rack service / emergency fire fighting only, not to be used for washdown

**Features:**

- outer construction: single jacket, all polyester
- tube construction: clear thermoplastic
- proof pressure: **500 PSI** at ambient temperature **70°F (21°C)**
- service test pressure: **250 PSI** at ambient temperature **70°F (21°C)**
- working pressure: **225 PSI** at ambient temperature **70°F (21°C)**

**Coupled with female and male expansion ring couplings**

Size	Coupling Type	Length	Folded Part #	Coiled Part #
1½"	combo lug, brass NST (NH)	50'	<b>R515-50CBF/F</b>	<b>R515-50CBF</b>
	combo lug, brass NST (NH)	100'	<b>R515100CBF/F</b>	<b>R515100CBF</b>
	combo lug, alum. NST (NH)	50'	<b>R515-50RAF/F</b>	<b>R515-50RAF</b>
	combo lug, alum. NST (NH)	100'	<b>R515100RAF/F</b>	<b>R515100RAF</b>

500# Nitrile Covered Fire Hose - Light Duty Red

**Application:**

- ideal for industrial and construction washdown and discharge applications

**Features:**

- outer construction: thin ribbed nitrile
- tube construction: nitrile
- proof pressure: **500 PSI** at ambient temperature **70°F (21°C)**
- service test pressure: **250 PSI** at ambient temperature **70°F (21°C)**
- working pressure: **225 PSI** at ambient temperature **70°F (21°C)**
- other colors, threads and configurations are available, consult Dixon®

**Uncoupled**



Size	Bowl	Length	Part #
1½"	1-13/16"	50'	<b>H515R50UC</b>
2½"	2-13/16"	50'	<b>H525R50UC</b>
1½"	1-13/16"	100'	<b>H515R100UC</b>
2½"	2-13/16"	100'	<b>H525R100UC</b>

**Coupled with female and male expansion ring couplings**



Size	Length	Rocker Lug Aluminum NST (NH) Part #	Rocker Lug Brass NST (NH) Part #	Rocker Lug Aluminum NPSH Part #
1½"	50'	<b>H515R50RAF</b>	<b>H515R50RBF</b>	<b>H515R50RAS</b>
2½"	50'	<b>H525R50RAF</b>	<b>H525R50RBF</b>	<b>H525R50RAS</b>
1½"	100'	<b>H515R100RAF</b>	---	<b>H515R100RAS</b>
2½"	100'	<b>H525R100RAF</b>	---	---

## Forestry Non Weeping Fire Hose

### Features:

- outer construction: single jacket, all polyester
- tube construction: thermoplastic
- impregnation: yellow
- proof pressure: **600 PSI** at ambient temperature **70°F (21°C)**
- service test pressure: **300 PSI** at ambient temperature **70°F (21°C)**
- working pressure: **270 PSI** at ambient temperature **70°F (21°C)**
- consult Dixon® for pricing and availability of 25' lengths, other threads and configurations

### Coupled with female and male expansion ring couplings

Size	Length	Rocker Lug Aluminum NST (NH) Part #	Rocker Lug Aluminum NPSH Part #
1"	50'	<b>NF610Y50RAF</b>	<b>NF610Y50RAS</b>
1"	100'	<b>NF610Y100RAF</b>	<b>NF610Y100RAS</b>
1½"	50'	<b>NF615Y50RAF</b>	<b>NF615Y50RAS</b>
1½"	100'	<b>NF615Y100RAF</b>	<b>NF615Y100RAS</b>



## Forestry Mop Up Hose

### Application:

- used on mop-up and low volume hand lines to fill pump cans supplying sprinklers and remote fire line protection

### Features:

- 50' coil diameter is 9"
- outer construction: single jacket, synthetic
- tube construction: thermoplastic
- impregnation: yellow
- proof pressure: **300 PSI** at ambient temperature **70°F (21°C)**
- service test pressure: **150 PSI** at ambient temperature **70°F (21°C)**
- working pressure: **135 PSI** at ambient temperature **70°F (21°C)**
- consult Dixon™ for pricing and availability of other threads and configurations

### Coupled with female and male brass ferrule type garden hose couplings

Size	Length	Part #
¾"	50'	<b>NF307Y50GHT</b>
1½"	50'	<b>NF615-50RAQT<sup>1</sup></b>
1½"	100'	<b>NF615100RAQT<sup>1</sup></b>

<sup>1</sup> coupled with quarter turn forestry couplings



## Forestry Mop Up Hose Kit

Description	Part #
kit contains: hose, pouch and nozzle	<b>NF307Y50GHT-KIT</b>



## Nitrile Covered Fire Hose - Heavy Duty - Yellow

**Applications:**

- ideal for heavy-duty washdown in refineries and power plants

**Features:**

- extruded interlocking matrix fire hose with 100% synthetic circular woven polyester reinforcement
- heavy ribbed for severe service
- outer construction: thick ribbed nitrile
- tube construction: nitrile
- 25' lengths, other colors, threads and configurations are available, contact Dixon®
- Pressures supplied in the chart below are at ambient temperature **70°F (21°C)**.

Size	Proof Pressure PSI	Service Test Pressure PSI	Working Pressure PSI
1" - 3"	<b>600</b>	<b>300</b>	<b>270</b>
4"	<b>450</b>	<b>225</b>	<b>200</b>
5"	<b>400</b>	<b>200</b>	<b>180</b>
6"	<b>300</b>	<b>150</b>	<b>135</b>

Fire Fittings & Accessories



**Uncoupled**

Size	Bowl	Length	Part #
1"	1-1/4"	50'	<b>H610Y50UC</b>
1½"	1-13/16"	50'	<b>H615Y50UC</b>
2"	2-1/4"	50'	<b>H620Y50UC</b>
2½"	2-13/16"	50'	<b>H625Y50UC</b>
3"	3-3/8"	50'	<b>H630Y50UC</b>
4"	4-3/8"	50'	<b>H440Y50UC</b>
5"	5-3/8"	50'	<b>H450Y50UC</b>

**Coupled with female and male expansion ring couplings**



Size	Length	Rocker Lug <i>Aluminum</i> NST (NH) RAF	Rocker Lug <i>Brass</i> NST (NH) RBF	Pin Lug <i>Brass</i> NST (NH) PBF	Rocker Lug <i>Aluminum</i> NPSH RAS
1"	50'	<b>H610Y50RAF</b>	---	---	<b>H610Y50RAS</b>
1½"	50'	<b>H615Y50RAF</b>	<b>H615Y50RBF</b>	<b>H615Y50PBF</b>	<b>H615Y50RAS</b>
2½"	50'	<b>H625Y50RAF</b>	<b>H625Y50RBF</b>	<b>H625Y50PBF</b>	<b>H625Y50RAS</b>

**Coupled with female and male segmented Storz collar style couplings**

**Features:**

- working pressures can be achieved using appropriate expansion ring couplings
- under no circumstance should the hose be used beyond the working pressure of the fittings to which it is coupled
- assembled hose should be hydrostatically proof tested before use, and thereafter in accordance with NFPA 1962



Size	Length	Storz Size	Part #
4"	50'	4"	<b>H440Y50SZ</b>
5"	50'	5"	<b>H450Y50SZ</b>
5"	100'	5"	<b>H450Y100SZ</b>

## Non-collapsible Hose

### Chemical Booster Hose - Red

**Features:**

- outer cover material: specially compounded red EPDM tough cover
- inner tube material: smooth black synthetic EPDM rubber
- reinforced with multiple plies of high tensile Aramid yarn providing flexible strength
- ¾" diameter hose is coupled with 1" threaded couplings
- meets and exceeds NFPA standard 1961
- working pressure: **800 PSI**

**Coupled with female and male NST (NH) thread, chromed brass hole type couplings**

Size	Length	Part #
¾"	50'	<b>80B07-50HCF</b>
	100'	<b>80B07-100HCF</b>
1"	50'	<b>80B10-50HCF</b>
	100'	<b>80B10-100HCF</b>

**Coupled with female and male NST (NH) thread, hole type coupling, aluminum expansion ring couplings**

Size	Length	Part #
¾"	50'	<b>80B07-50HAF</b>
	100'	<b>80B07-100HAF</b>
1"	50'	<b>80B10-50HAF</b>
	100'	<b>80B10-100HAF</b>



### Fire and Utility Hose - Red

**Features:**

- outer construction is designed to withstand abrasion
- working pressure: **200 PSI** at ambient temperature **70°F (21°C)**
- burst pressure: **600 PSI** at ambient temperature **70°F (21°C)**
- consult Dixon® for pricing and availability of other lengths, threads and configurations
- also available with chrome brass fittings

**Coupled with female and male NST (NH) thread, rocker lug, brass expansion ring couplings**

Size	Length	Part #
1½"	50'	<b>15B15-50RBF</b>
	100'	<b>15B15-100RBF</b>



**Coupled with female and male NST (NH) thread, rocker lug, aluminum expansion ring couplings**

Size	Length	Part #
1½"	50'	<b>15B15-50RAF</b>
	100'	<b>15B15-100RAF</b>



**Coupled with female and male NPSH thread, rocker lug, aluminum expansion ring couplings**

Size	Length	Part #
1½"	50'	<b>15B15-50RAS</b>
	100'	<b>15B15-100RAS</b>



Expansion Ring Couplings

Features:

- shipped complete with expansion rings, swivel and tail washers
- aluminum expansion ring couplings have 3 rocker lugs on the male and female

For Single Jacket Hose - Aluminum

Size	Thread	Bowl	Aluminum Part #
1"	NPSH	1¼"	<b>S10125</b>
1½"	NPSH	1¾"	<b>S16175</b>
1½"	NPSH	1-11/16"	<b>S16168</b>
1½"	NPSH	1-13/16"	<b>S16181</b>
2"	NPSH	2¼"	<b>S20225</b>
2½"	NPSH	2-13/16"	<b>S26281</b>
1½"	NST (NH)	1-11/16"	<b>S16168F</b>
1½"	NST (NH)	1¾"	<b>S16175F</b>
1½"	NST (NH)	1-13/16"	<b>S16181F</b>
2½"	NST (NH)	2-11/16"	<b>S26268F</b>
2½"	NST (NH)	2-13/16"	<b>S26281F</b>
1½"	MNPT	1-11/16"	<b>MS16168T<sup>1</sup></b>
1½"	MNPT	1¾"	<b>MS16175T<sup>1</sup></b>
2"	MNPT	2-1/4"	<b>MS20225T<sup>1</sup></b>
2½"	MNPT	2-11/16"	<b>MS26268T<sup>1</sup></b>

<sup>1</sup> male fitting only



For Single Jacket Hose - Brass

Size	Thread	Bowl	Brass Part #
1½"	NPSH	1-3/4"	<b>RS15175</b>
1½"	NPSH	1-13/16"	<b>RS15181</b>
2½"	NPSH	2-13/16"	<b>RS25281</b>
1½"	NST (NH)	1-3/4"	<b>RS15175F</b>
1½"	NST (NH)	1-13/16"	<b>RS15181F</b>
2½"	NST (NH)	2-13/16"	<b>RS25281F</b>

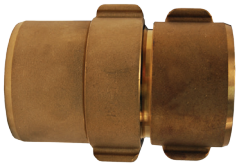

Expansion Ring Couplings

For Double Jacket Hose - Aluminum

Size	Thread	Bowl	Aluminum Part #
1½"	NPSH	1-13/16"	<b>D16181</b>
1½"	NPSH	1-15/16"	<b>D16193</b>
1½"	NPSH	2-1/16"	<b>D16206</b>
2"	NPSH	2-5/16"	<b>D20231</b>
2½"	NPSH	3"	<b>D263</b>
1½"	NST (NH)	1-13/16"	<b>D16181F</b>
1½"	NST (NH)	1-15/16"	<b>D16193F</b>
1½"	NST (NH)	2-1/16"	<b>D16206F</b>
2½"	NST (NH)	2-7/8"	<b>D26287F</b>
2½"	NST (NH)	3"	<b>D263F</b>
1½"	MNPT	1-13/16"	<b>MD16181T<sup>1</sup></b>
2"	MNPT	2-5/16"	<b>MD20231T<sup>1</sup></b>
2½"	MNPT	2-7/8"	<b>MD26287T<sup>1</sup></b>

<sup>1</sup> male fitting only



For Double Jacket Hose - Brass

Size	Thread	Bowl	Brass Part #
1½"	NPSH	1-15/16"	<b>RD15193</b>
1½"	NST (NH)	1-15/16"	<b>RD15193F</b>

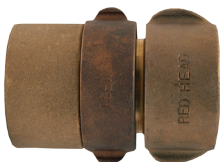

### Expansion Rings

- used with the fire hose couplings listed on page 740

OD	Length	Wall Thickness	85/15 red brass Part #
1"	1¼"	.05	<b>ER10125</b>
1½"	¾"	.05	<b>ER1575</b>
1½"	7⁄8"	.05	<b>ER1587</b>
1½"	1"	.05	<b>ER1510</b>
1½"	1¼"	.05	<b>ER15125</b>
1¾"	1¼"	.05	<b>ER17125</b>
2½"	1¼"	.062	<b>ER27125</b>
2½"	1½"	.062	<b>ER27150</b>
3"	2"	.07	<b>ER3020</b>



### Swivel Washers

- used on the swivel end of the fire hose couplings listed on page 740

ID	OD	Thickness	Buna-N Part #
1-1/16"	1-7/16"	⅛"	<b>SW100F</b>
1-9/16"	2-1/16"	⅛"	<b>SW150</b>
2-1/16"	2½"	⅛"	<b>SW200</b>
2-9/16"	3-3/16"	3/16"	<b>SW250</b>
3-1/16"	3-3/4"	¼"	<b>SW300F</b>
4-1/16"	5-1/8"	¼"	<b>SW400F</b>
4-9/16"	5-7/8"	¼"	<b>SW450F</b>
5-1/16"	6-3/8"	¼"	<b>SW500F</b>
6-1/16"	7-1/8"	¼"	<b>SW600F</b>



### Tail Washers

- used on the tail end of the fire hose couplings listed on page 740

ID	OD	Thickness	Buna-N Part #
1-1/32"	1-5/16"	3/16"	<b>STW100</b>
1-9/16"	1¾"	3/16"	<b>RTW150</b>
1-9/16"	1-15/16"	3/16"	<b>STW150</b>
1-5⁄8"	2⅝"	3/16"	<b>DTW150</b>
2-9/16"	3"	¼"	<b>STW250</b>
2-5⁄8"	3¼"	¼"	<b>DTW250</b>
3⁄8"	3-25/32"	¼"	<b>DTW300</b>



Expansion Ring and Gasket Guide

Fire Fittings & Accessories

Coupling Part #	Swivel Washer Part #	Tail Washer Part #	Expansion Ring Part #
D15193 & D15193F	SW150	DTW150	ER15125
D15206F	SW150	G12014	ER15125
D16187 & D16187F	SW150	DTW150	ER15125
D16193 & D16193F	SW150	DTW150	ER15125
D16206 & D16206F	SW150	G12014	ER15125
D253 & D253F	SW250	DTW250	ER27150
D26287F	SW250	DTW250	ER27150
D263 & D263F	SW250	DTW250	ER27150
MD16181T	n/a	STW150	ER15125
MD20231T	n/a	special	special
MD26287T	n/a	DTW250	ER27150
MS16168T	n/a	STW150	ER15125
MS16175T	n/a	STW150	ER15125
MS20225T	n/a	special	special
MS26268T	n/a	STW250	ER27150
RD15193 & RD15193F	SW150	DTW150	ER15125
RD15206 & RD15206F	SW150	G12014	ER15125
RD253 & RD253F	SW250	DTW250	ER27150
RH15168 & RH15168F	SW150	RTW150	ER1575
RH16168F & RH16168F	SW150	RTW150	ER1575
RS15175 & RS15175F	SW150	STW150	ER15125
RS15181 & RS15181F	SW150	STW150	ER1510
RS25281 & RS25281F	SW250	STW250	ER27125
RS25287	SW250	STW250	ER27150
S15175 & S15175F	SW150	RTW150	ER15125
S15181 & S15181F	SW150	RTW150	ER1510
S16168 & S16168F	SW150	STW150	ER15125
S16175 & S16175F	SW150	STW150	ER15125
S16181 & S16181F	SW150	STW150	ER15125
S25281 & S25281F	SW250	STW250	ER27125
S25287 & S25287F	SW250	STW250	ER27150
S26268 & S26268F	SW250	STW250	ER27150
S26275 & S26275F	SW250	STW250	ER27150
S26281 & S26281F	SW250	STW250	ER27150



## Hose Type Booster Hose Couplings

**Features:**

- special tooling is required to attach these couplings to hose
- hardcoat finish
- complete set
- working pressure: **800 PSI** at ambient temperature **70°F (21°C)**
- ¾" and 1" NST threads are the same size; also known as **Chemical Hose Thread (CHT)** or **Booster Hose Thread**



Hose Size	Thread Type	Bowl Size	Aluminum Hardcoat Part #
¾"	1" NPSH	1-1/4"	<b>ABH08125</b>
1"	1" NST (NH)	1-7/16"	<b>ABH10143F</b>
1"	1" NST (NH)	1-1/2"	<b>ABH10150F</b>

## Forged Forestry Couplings

**Features:**

- maximum operating pressure: **300 PSI** at ambient temperature **70°F (21°C)**
- common quarter turn sexless head (a 1½" QT fitting will mate with a ¾" QT or 1" QT)

### ¼ Turn Male

Thread	Forged Aluminum Part #
¾" GHT	<b>QTM75GHT-F</b>
1" NPSH	<b>QTM100S-F</b>
1" NPT	<b>QTM100T-F</b>
1½" NST (NH)	<b>QTM150F-F</b>
1½" NPT	<b>QTM150T-F</b>



### ¼ Turn Female

Thread	Forged Aluminum Part #
¾" GHT	<b>QTF75GHT-F</b>
1" NPSH	<b>QTF100S-F</b>
1" NPT	<b>QTF100T-F</b>
1½" NST (NH)	<b>QTF150F-F</b>
1½" NPT	<b>QTF150T-F</b>



### Forestry Coupling Gasket

Part #
<b>QTG-F</b>



## Quick Connect Forestry Expansion Ring Couplings

- sold in sets of (2) with expansion ring

Hose Size	Bowl Size	Forged Aluminum Part #
1½"	1-11/16"	<b>QTX150-F</b>



## Style V Swing Type Hose Storage Reels

Fire Fittings & Accessories

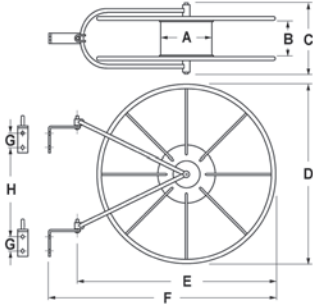

**Features:**

- drum storage of collapsible hose prevents damaging kinks allowing longer hose life
- pivot mounting permits reel to swing to the proper angle preventing twists and kinks
- open sides allow faster hose drying, to prevent mold and mildew
- red polyester powder coat finish
- wall mounting is standard, 2 wall mounting brackets included
- style V5 (when used with 1½" hose only), has a space between the reel sides to accommodate two widths of hose side by side, for maximum capacity in minimum space
- replacement brackets - **1212-0930-4**, 2 per set

Size	Hose Capacity			A	B	C	D	E	F	G	H	Steel Part #
	Rack	Single	Double									
1½" - 1¾"	100'	75'	50'	8"	3"	7½"	21"	23"	27"	2"	11⅜"	<b>FHR-V1</b>
1½" - 1¾"	150'	100'	75'	8"	3"	7½"	26"	29"	33"	2"	15"	<b>FHR-V2</b>
1½"	300'	200'	150'	8"	5½"	9½"	26"	30"	34"	2"	13"	<b>FHR-V5</b>
2" - 2½"	150'	100'	75'	8"	5½"	9½"	26"	30"	34"	2"	13"	<b>FHR-V5</b>

### Covers for Style V Swing Type Hose Storage Reels

**Features:**

- Velcro™ closures
- printed on both sides



Cover for	Dimensions	Vinyl Coated Nylon Part #
FHR-V2	26"	<b>FHR-C</b>
FHR-V1	21"	<b>FHR-C1</b>
FHR-V5	26"	<b>HSRC26</b>

## Swing Type Hose Storage Reels

## Features:

- one piece wall bracket (14 gauge), for easier mounting
- 180° swing will also take pipe clamps to 3"
- compact size - smaller reel hub to allow more hose storage
- baked red enamel finish
- 14 gauge steel support arms
- welded construction - rim (18 gauge) hub cap, welded spokes form solid wheels, separated by a molded poly hub and bolted together to form a sturdy unit
- hose is double rolled from the center of length coupled to valve and nozzle
- hose is ready for action when completely removed and valve is open

Hose Size	Hose Capacity		Steel Part #
	Lightweight	Rubber Lined	
1½"	150'	50' - 75'	<b>HSR18</b>
	250'	100'	<b>HSR24</b>
2½"	100'	100'	<b>HSR25-24</b>

## Dimensions

Cover for	A	B	C
HSR18	18"	23½"	6¼"
HSR24	24"	29"	6¼"
HSR25-24	24"	29"	8¼"



Fire Fittings &amp; Accessories

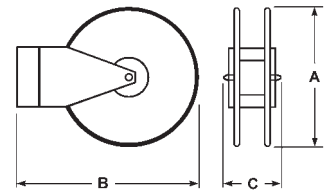

## Covers for Swing Type Hose Reels

## Features:

- to be used with hose storage reels, bright red fabric reinforced PVC with Velcro™ closures for quick release
- "Fire Hose / Keep Clear" printed on one side

Cover for	Dimensions	Vinyl Part #
HSR18	16" - 18"	<b>HSRC18</b>
HSR24	24"	<b>HSRC24</b>
HSR25-24	24" - 25"	<b>HSRC25-24</b>



## Heavy Duty, High Capacity Swing Type Hose Storage Reel

## Features:

- welded steel wall bracket swings 180°
- wall bracket adapts to pipes (1½" - 3") with an optional pipe bracket kit
- red baked enamel finish
- supplied with hook-and-loop back strap to keep hose securely wound

Size	Hose Capacity		16-gauge steel Part #
	Single Jacket	Double Jacket	
1½"	200'	150'	<b>DXHDR25HC</b>
2½"	100'	75'	



## Cover for Heavy Duty Swing Type Hose Storage Reel

## Features:

- to be used with hose storage reels
- "Fire Hose / Keep Clear" printed on one side

Cover for	Dimensions	Vinyl Part #
DXHDR25HC	l: 26", h: 25", w: 8"	<b>DXHDC25HC</b>



## Pipe Brackets for Heavy Duty Swing Type Hose Storage Reel

Description	Vinyl Part #
pipe bracket set	<b>DXHDR25PB</b>



Global Continuous Flow Reels

Fire Fittings & Accessories

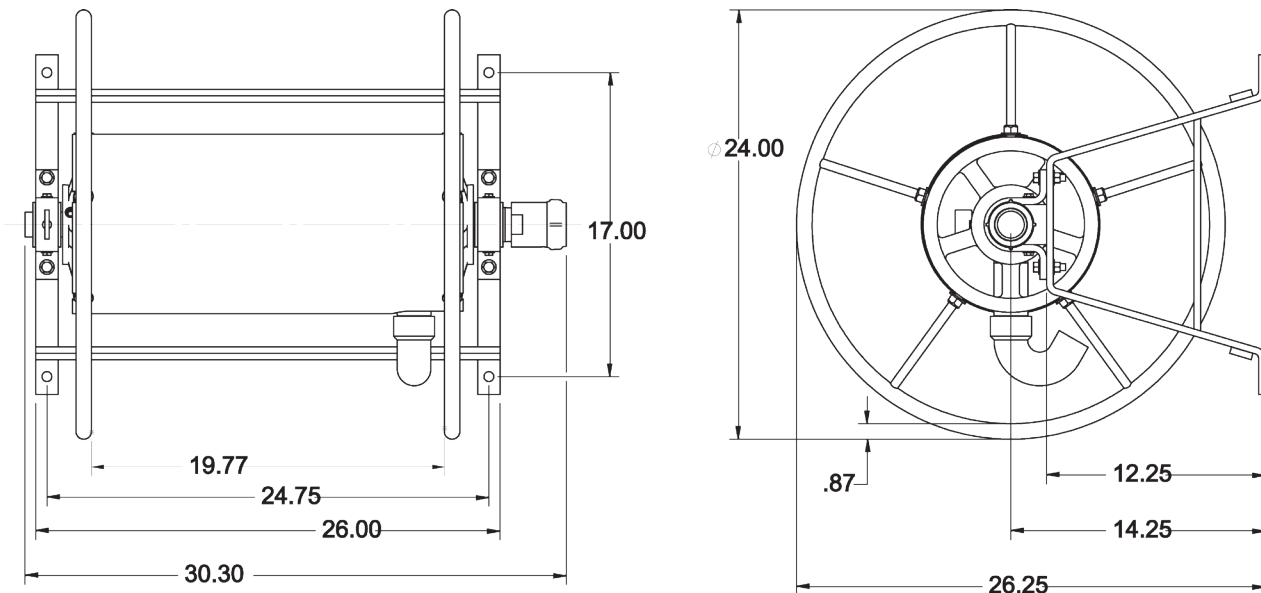

Features:

- greaseless swivel and reel bearings improve performance
- optional adapters (order separately):  
 FM15S15F = 1½" FNPSH x 1½" MNST brass  
 FM1515F = 1½" FNPT x 1½" MNST brass
- replacement inlet swivel joints at bottom of page



Hose Size and Capacity			Inlet Size	Outlet Size	Steel Part #
¾"	1"	1½"	1½" NPT	1½" NPT	<b>FD47IR-150-100</b>
250'	150'	100'			

Cover for Global Continuous Flow Hose Reel



Cover for	Dimensions	Vinyl Part #
FD47IR-150-100	22" x 24" x 24"	<b>FD47-C2</b>

Replacement Inlet Swivel Joint for FD471-150-100



Features:

- ball-bearing swivel
- requires no lubrication
- **200 PSI**

Size	Cast Brass Part #
1½"	<b>CSSF150T</b>

## Continuous Flow Reels

**Features:**

- allows immediate and continuous flow of water at all times during deployment of hose
- one-person operation
- use with non-collapsible hose shown on page 749
- powder coated with an electrostatically-applied, thermally-fused, red polyester finish steel drum
- rims and universal mounting stand
- female NPT inlet with male NST (NH) hose thread outlet

A flexible connector assembly must be installed directly between the hose reel inlet hub and the water supply. *Failure to use the flexible connector assembly will void the warranty.*

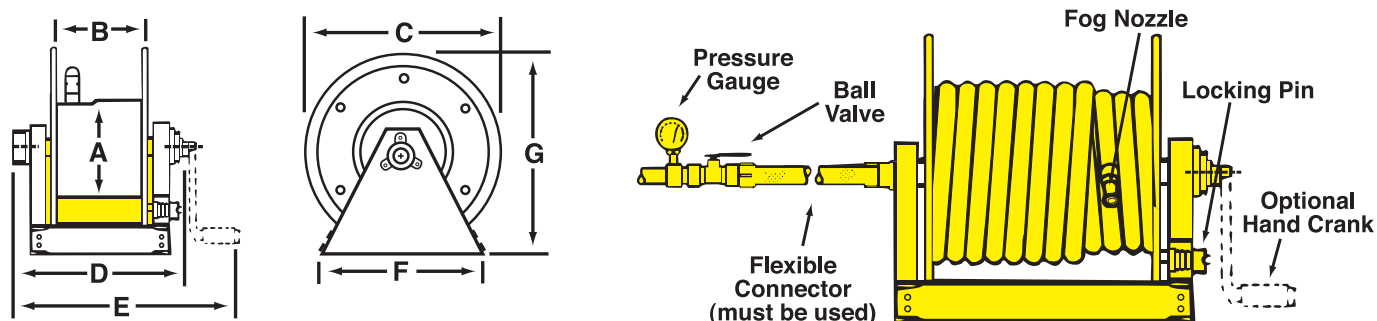

Hose Size and Capacity			A	B	C	D	E	F	G	Inlet Size	Outlet Size	Steel Part #
3/4"	1"	1 1/2"										
150'	125'	---	10 1/2"	11 1/2"	24"	19 1/4"	24"	21 3/4"	26"	1"	1"	<b>CFR47-1-100</b>
250'	150'	100'	10 1/2"	20 1/2"	24"	28 1/4"	33"	21 3/4"	26"	1 1/2"	1 1/2"	<b>CFR47-150-100</b>
400'	300'	150'	10 1/2"	28"	24"	35 3/4"	40 1/2"	21 3/4"	26"	1 1/2"	1 1/2"	<b>CFR47-1-200</b>
---	---	200'	10 1/2"	34"	24"	41 3/4"	46 1/2"	21 3/4"	26"	1 1/2"	1 1/2"	<b>CFR47-150-200</b>

### Optional Accessories

Description	Part #
1" x 18" flexible connector (male NPT x male NPT)	<b>DX2836</b>
1 1/2" x 18" flexible connector (male NPT x male NPT)	<b>DX2839</b>
hand crank	<b>CFR-HC</b>
repair kit: contains O-ring, PTFE retaining ring for the inlet casting, spacer washer, and 2 steel retaining rings for the manifold	<b>CFR-RK</b>

### Covers for Continuous Flow Hose Reels

Cover for	Dimensions H x W x D	Vinyl Part #
CFR47-1-100	26" x 20" x 26"	<b>CFR47-C1</b>
CFR47-1-200	26" x 36" x 26"	<b>CFR47-C2</b>
CFR47-150-100	26" x 29" x 26"	<b>CFR47-C3</b>
CFR47-150-200	26" x 42" x 26"	<b>CFR47-C4</b>



## Hump Racks

## Features:

- compact, neat and economical method of storing collapsible hose
- pivot mounting permits rack to swing, preventing kinks and twists
- rugged steel construction provides long, dependable service
- red enamel finish for protection
- open sides allow faster drying to prevent mold and mildew
- wall mounting brackets are standard

Hose Size	Hose Capacity			Steel Part #
	Synthetic	Single Jacket	Double Jacket	
1½" - 1¾"	100'	50'	---	<b>FHHR-1</b>
1½" - 1¾"	150'	100'	50'	<b>FHHR-3</b>
2" - 2½"	100'	50'	---	<b>FHHR-2</b>
2" - 2½"	150'	100'	50'	<b>FHHR-4</b>
1½" - 1¾"	200'	150'	100'	<b>FHHR-5</b>

Fire Fittings &amp; Accessories



## Covers for Hump Racks



Cover for	Dimensions	Vinyl Part #
FHHR-1 or FHHR-2	16" x 25½" x 6"	<b>FHHR-C</b>
FHHR-3 or FHHR-4	24" x 29½" x 6"	<b>FHHR-C4</b>
FHHR-5	33½" x 35½" x 6"	<b>FHHR-C5</b>

## Hose Racks

## Features:

- can be used for fire or water hose
- constructed from 12 gauge sheet steel
- provides compact and economical hose storage
- curved saddle design avoids sharp bends in the hose prolonging hose life
- red enamel finish

Hose Size	Rack	Hose Capacity		Steel Part #
		Single Jacket	Double Jacket	
1½" - 1¾"	50'	---	---	<b>HR1610-3</b>
1½" - 1¾"	100'	---	---	<b>HR1610-6</b>
1½" - 2½"	200'	150'	100'	<b>HR1610</b>
2" - 2½"	50'	---	---	<b>HR1610-4</b>



Pin Rack Hose Assembly



**Features:**

- components include: rack nipple, UL **300 PSI** angle valve, semi-automatic fire hose pin rack, brass rack nozzle, and a length of 1½" pin rack hose
- UL listed and Factory Mutual approved
- per NFPA 1962, Chap. 4, in-service hose shall be un-racked and physically inspected at least annually



Fire Fittings & Accessories

NST (NH) Thread	Hose	Part #
1½"	50'	<b>FHPR150-50CBF</b>
	75'	<b>FHPR150-75CBF</b>
	100'	<b>FHPR150-100CBF</b>

Semi Automatic Fire Hose Pin Racks

**Features:**

- red enameled steel
- holds up to 100' of either 1½" or 2½" rack hose
- 1½" is UL listed and Factory Mutual approved

Hose Size	For use with:		Steel Part #
	Valve	Nipple	
1½"	AVF150	PRN150F	<b>FHPR150</b>
2½"	AVF250	PRN250F	<b>FHPR2515</b>



Covers for Pin Racks

**Features:**

- 10 oz. red vinyl with Velcro™ closures
- used on FHPR150, FHPR150-50CBF, FHPR150-75CBF, FHPR150-100CBF

Size	Vinyl Part #
25" x 30" x 6"	<b>PRC</b>



Pin Rack Nipples

**Feature:**

- finish: -C polished chrome plated

Male NPT	Male NST (NH)	Brass Part #
1½"	1½"	<b>PRN150F</b>
2½"	2½"	<b>PRN250F</b>



Pin Rack Wall Bracket

**Application:**

- used to support hose rack independent of a stand pipe valve

Aluminum Part #
<b>PRWB</b>



## Steel Hose Cabinet

Fire Fittings &amp; Accessories

**Features:**

- red polyester coated finish on 18-gauge steel
- designed for wall installation, with or without legs, or free standing
- supplied with holes in the back for wall mounting and 1" pipe couplings on the bottom for adding legs
- Factory Mutual approved
- hose, accessories and mounting hardware not included
- furnished without legs, if legs required contact Dixon®

Steel

Part #

**HC30143****Dimensions**

width	depth	height
60"	15"	48"

**Basic Approved Equipment for Hose Cabinet**

Examples			Quantity Required		
Part #	Description	Page #	Factory Mutual	UL & FIA	ISO
<b>A525-50RAF</b> <sup>1</sup>	2½" x 50' single jacket hose	733	4	5	5
<b>A515-50RAF</b> <sup>1</sup>	1½" x 50' single jacket hose	733	2	0	0
<b>UPP250F</b> <sup>1</sup>	Underwriters play pipe	750	0	2	2
<b>BFN250NST</b> <sup>1</sup>	2½" adjustable fog nozzle	752	2	0	0
<b>BFN150NST</b> <sup>1</sup>	1½" adjustable fog nozzle	752	1	0	0
<b>HA2515F</b> <sup>1</sup>	2½" x 1½" pin lug adapter	771	1	0	0
<b>233</b>	universal spanner	799	4	5	5
<b>189</b>	adjustable hydrant wrench	800	2	2	2
<b>PHFA6</b>	6 lb. fire axe	820	0	1	1
<b>FCB48</b>	crowbar	---	0	1	1
<b>SW150</b> <sup>1</sup>	1½" hose coupling gasket	741, 742, 754, 785	4	5	5
<b>SW250</b> <sup>1</sup>	2½" hose coupling gasket	741, 742, 754, 785, 792	2	0	0

<sup>1</sup> threads must be appropriate to the authority having jurisdiction



## Fire Jacket for Hose

**Application:**

- used to protect hose and hose assemblies, tubing, piping, wiring and cables from high temperatures, direct flame or molten splash

**Features:**

- helps maintain line temperature and reduce environmental overheating and overcooling
- meets flammability requirements of UL 94 HB & UL 94 V-0
- sleeving slides easily over hose and expands to go over fittings
- resistant to hydraulic fluids and lubricating oil
- iron oxide red color
- compounded silicone rubber coating over fiberglass
- completely non-asbestos, REACH - ROHS compliant
- supplied in 50' lengths
- temperature range: **-65°F to 500°F (-54°C to 260°C)**
- Made in USA

Nominal ID	Part #
1/4"	<b>0610-4</b>
3/8"	<b>1010-6</b>
1/2"	<b>1310-8</b>
5/8"	<b>1610-10</b>
3/4"	<b>1910-12</b>
7/8"	<b>2210-14</b>
1"	<b>2510-16</b>
1 1/4"	<b>3210-20</b>
1 1/2"	<b>3810-24</b>
1 3/4"	<b>4510-28</b>
2"	<b>5110-32</b>
2 1/2"	<b>6410-40</b>
3"	<b>7610-48</b>
4"	<b>10210-64</b>



## Fire Jacket Tape

**Application:**

- used to seal the ends of fire jackets to prevent fraying and fluid wicking

**Features:**

- completely non-asbestos
- iron oxide red color
- temperature range: **-45°F to 380°F (-45°C to 200°C)**
- Made in USA

Size	Length	Silicone Rubber Part #
1"	12 yards	<b>FTH100</b>



## Non Adhesive Fire Tape

**Features:**

- fiberglass coated silicone rubber
- fluid resistant to hydraulic fluids and lubricating oils
- should be installed in a spiral wrap utilizing 30% to 50% overlap
- iron oxide red color
- temperature range: **-65°F to 500°F (-54°C to 260°C)**
- Made in USA

Width	Length	Fiberglass Coated Silicone Rubber Part #
3"	50'	<b>4055-3</b>





### Industrial Fog Nozzles



**Features:**

- maximum operating pressure: **175 PSI** (water only) at **70°F (21°C)**
- delivers 30° - 60° - 90° fog pattern - shut-off - straight stream - fog
- UL listed and Factory Mutual approved for class A and B fires (except noted <sup>1,2</sup>)
- supplied with bumper

Size	Thread	90° Spray GPM @ 100 PSI	Brass Part #
¾"	GHT	---	<b>BFN75GHT</b> <sup>1</sup>
¾"	NPSH	---	<b>BFN75</b>
1"	NPSH	<b>32</b>	<b>BFN100</b>
1½"	NPSH	<b>85</b>	<b>BFN150</b>
2"	NPSH	<b>108</b>	<b>BFN200</b> <sup>1,2</sup>
1"	NST (NH)	<b>32</b>	<b>BFN100NST</b>
1½"	NST (NH)	<b>85</b>	<b>BFN150NST</b>
2½"	NST (NH)	<b>205</b>	<b>BFN250NST</b> <sup>2</sup>

<sup>1</sup> not UL Listed

<sup>2</sup> not Factory Mutual approved

• replacement washers can be found on page 741



### Heavy Duty Industrial Fog Nozzles



**Features:**

- maximum operating pressure: **175 PSI** (water only) at **70°F (21°C)**
- delivers 30° - 60° - 90° fog pattern - shut-off - straight stream - fog
- UL listed and Factory Mutual approved
- New UL and FM approvals are pending due to change in standard UL 401
- Products are to be reapproved, data subject to change in coming months
- supplied with bumper

Size	Thread	90° Spray GPM @ 100 PSI	Brass Part #
1"	NPSH	---	<b>HFN100</b>
1½"	NPSH	<b>88 (+/-12)</b>	<b>HFN150</b>
1"	NST (NH)	---	<b>HFN100NST</b>
1½"	NST (NH)	<b>88 (+/-12)</b>	<b>HFN150NST</b>
1½"	NYFD	---	<b>HFN150NYFD</b>

• replacement washers can be found on page 741, flow rate chart on following page 753



### High Pressure Industrial Fog Nozzles



**Features:**

- working pressure: **25 to 300 PSI** (water only) at **70°F (21°C)**
- combination straight stream and fog - shut-off - straight stream - fog
- Factory Mutual approved
- large one-piece rubber bumper with molded teeth
- knurled base

Size	Thread	90° Spray GPM @ 100 PSI	Brass Part #
1½"	NPSH	<b>117</b>	<b>HPFN150</b>
1½"	NST (NH)	<b>117</b>	<b>HPFN150NST</b>

• replacement washers can be found on page 741, flow rate chart on following page 753



### Electrical Fire All-Fog Nozzles



**Features:**

- maximum operating pressure: **100 PSI** (water only) at **70°F (21°C)**
- delivers 30° - 60° - 90° fog pattern - shutoff to 30° fog, adjustable to 90° fog
- UL listed and Factory Mutual approved for class C fires
- New UL and FM approvals are pending due to change in standard UL 401
- Products are to be reapproved, data subject to change in coming months
- supplied with bumper
- Use of this nozzle is not likely to prove hazardous when nozzle is held in excess of 10 feet from electrical apparatus and circuits not involving more than 250,000 volts.

Size	Thread	Wide Open GPM @ 100 PSI	Brass Part #
1½"	NST (NH)	<b>96</b>	<b>BFNE150NST</b>
1½"	NPSH	<b>96</b>	<b>BFNE150</b>

• replacement washers can be found on page 741, flow rate chart on following page 753

Fog Nozzles

Features:

- shutoff - straight stream - fog
- maximum operating pressure: **100 PSI** (water only) at **70°F (21°C)**
- brass stem

Size	Thread	90° Spray GPM @ 100 PSI	Polycarbonate <sup>1</sup> Part #	Polycarbonate <sup>2</sup> Part #
¾"	GHT	<b>8.0</b>	<b>FNB75GHT</b> <sup>3,4</sup>	---
¾"	NPS	<b>30.9</b>	<b>FNB75S</b> <sup>4</sup>	---
1"	NPS	<b>11.4</b>	<b>FNB100S</b> <sup>4</sup>	<b>FN100S</b>
1"	NPS	<b>30.9</b>	<b>HGB100S</b>	---
1½"	NPS	<b>83.6</b>	<b>FNB150S</b>	<b>FN150S</b>
1"	NST (NH)	<b>11.4</b>	<b>FNB100NST</b>	<b>FN100NST</b>
1"	NST (NH)	<b>30.9</b>	<b>HGB100NST</b>	---
1½"	NST (NH)	<b>83.6</b>	<b>FNB150NST</b>	<b>FN150NST</b>

<sup>1</sup> with bumper

<sup>2</sup> without bumper

<sup>3</sup> standard flow

<sup>4</sup> 120° spray GPM @100 PSI

- replacement washers can be found on page 741



with bumper



without bumper

Fire Fittings & Accessories

Fog Nozzle Flow Rate Chart

Part Number	Inlet Pressure		Straight Stream		30°		60°		90°	
	PSI	kPa	GPM	LPM	GPM	LPM	GPM	LPM	GPM	LPM
<b>BFN100</b>	<b>50</b>	(345)	18	(68)	21	(79)	24	(91)	27	(102)
	<b>75</b>	(517)	22	(83)	25	(95)	28	(106)	32	(121)
	<b>100</b>	(690)	24	(91)	28	(106)	32	(121)	36	(136)
<b>BFN250</b>	<b>50</b>	(345)	90	(341)	120	(454)	130	(492)	145	(549)
	<b>75</b>	(517)	100	(379)	140	(530)	150	(568)	180	(681)
	<b>100</b>	(690)	110	(416)	165	(625)	180	(681)	205	(776)
<b>HFN100</b>	<b>100</b>	(690)	25	(95)	---	---	---	---	---	---
<b>HFN150</b>	<b>100</b>	(690)	---	---	---	---	---	---	86	(326)
<b>HPFN150</b>	<b>275</b>	(1040)	---	---	---	---	---	---	130	(492)

Domestic Rack Nozzles



Features:

- maximum operating pressure: **100 PSI** (water only) at **70°F (21°C)**
- UL listed and Factory Mutual approved for class A and B fires
- New UL and FM approvals are pending due to change in standard UL 401
- Products are to be reapproved, data subject to change in coming months
- delivers 30° - 60° - 90° fog pattern - shut-off - straight stream - fog
- supplied without bumper

Size	Thread	Wide Open GPM @ 100 PSI	Brass Part #
1½"	NST (NH)	<b>100</b>	<b>BRN150NST</b>
	NPSH	<b>100</b>	<b>BRN150</b>



- replacement washers can be found on page 741

Global Rack Nozzles



Features:

- maximum operating pressure: **100 PSI** (water only) at **70°F (21°C)**
- UL listed and Factory Mutual approved for class A and B fires
- New UL and FM approvals are pending due to change in standard UL 401
- Products are to be reapproved, data subject to change in coming months
- delivers 30° - 60° - 90° fog pattern - shut-off - straight stream - fog
- supplied without bumper

Size	Thread	Wide Open GPM @ 100 PSI	Brass Part #
1½"	NST (NH)	<b>100</b>	<b>BRN150NST-I</b>
	NPSH	<b>100</b>	<b>BRN150S-I</b>



- replacement washers can be found on page 741

### Ball Shut-Offs



**Features:**

- full time swivel base ensures durable rubber-like handle can be positioned for easy operation
- maximum operating pressure: **100 PSI** (water only) at **70°F (21°C)**

Thread	Length	Waterway	Cast Brass Part #
1½" NST (NH)	4¾"	1⅜"	<b>BSO150NST</b>
1½" NPSH	4¾"	1⅜"	<b>BSO150S</b>

#### Replacement Part



Description	Composite Part #
replacement handle	<b>BSO150-H</b>

### Nozzle Tips



**Features:**

- straight stream only
- maximum operating pressure: **100 PSI** (water only) at **70°F (21°C)**
- **74 GPM @ 100 PSI**

Thread	Length	Orifice	Satin Brass Part #
1" NST (NH)	4¾"	½"	<b>BNT100F</b>
1" NPSH	4¾"	½"	<b>BNT100S</b>
1½" NST (NH)	4⅜"	½"	<b>BNT150F</b>
1½" NPSH	4⅜"	½"	<b>BNT150S</b>

### Plain Hose Nozzles



**Features:**

- finish: satin
- maximum operating pressure: **100 PSI** (water only) at **70°F (21°C)**

Size	Thread	Overall Length	Orifice	Replacement Gasket	Previous Part #	Brass
						Part #
¾"	GHT	6"	1/4"	<b>KRW5</b>	500SN6	<b>BN6</b>
¾"	NPSH	6"	1/4"	<b>KRW5</b>	---	<b>BN7</b>
1"	NPSH	8"	5/16"	<b>KRW10</b>	---	<b>BN10</b>
1¼"	NPSH	10"	3/8"	<b>KRW15</b>	---	<b>BN12</b>
1½"	NPSH	10"	1/2"	<b>KRW20</b>	---	<b>BN15</b>
2"	NPSH	12"	9/16"	<b>SW200</b>	---	<b>BN20</b>
2½"	NPSH	12"	1"	<b>KRW35</b>	---	<b>BN25</b>
1"	NST (NH)	8"	5/16"	<b>SW100F</b>	---	<b>BN10F</b>
1½"	NST (NH)	10"	1/2"	<b>SW150</b>	---	<b>BN15F</b>
2½"	NST (NH)	12"	1"	<b>SW250</b>	---	<b>BN25F</b>
1½"	NYFD	10"	1/2"	<b>SW150</b>	---	<b>BN15NYFD</b>
2½"	NYFD	12"	1"	<b>SW250</b>	---	<b>BN25NYFD</b>

### Twist Nozzles



**Feature:**

- maximum operating pressure **150 PSI** (water only)

Thread Size	Length	Previous Part #	Extruded Brass Part #
¾" GHT	4"	---	<b>BTN75</b>
	4"	---	<b>500AN4<sup>1</sup></b>
	6¾"	500-AN7	<b>500AN7<sup>1</sup></b>

<sup>1</sup> imported

Red Plain Hose Nozzles

Feature:

- maximum operating pressure: **100 PSI** (water only) at **70°F (21°C)**

Size	Thread	Length	Orifice	Polycarbonate Part #
1½"	NPSH	10"	½"	<b>PN15</b>
	NST (NH)	10"	½"	<b>PN15F</b>



Fire Fittings & Accessories

UL Play Pipes with Tip



Application:

- often required in hydrant houses by Insurance Underwriters

Features:

- swivel handle, red marlin trim
- maximum operating pressure: **100 PSI** (water only) at **70°F (21°C)**
- UL listed and Factory Mutual approved
- ULT male thread specification: 2-3/16" ODM x 12 TPI
- comes standard with 1⅝" orifice tip

Size	Female Thread	Male Thread	Overall Length	Brass Part #
2½"	NST (NH)	ULT	30"	<b>UPP250F</b>
		playpipe only		<b>UPP250F-SPEC</b>



Tips

Features:

- finish: satin
- maximum operating pressure: **100 PSI** (water only) at **70°F (21°C)**
- ULT male thread specification: 2-3/16" ODM x 12 TPI

Orifice	Cast Brass Part #
1⅝"	<b>UPPT</b>
1¼"	<b>UPPT125</b>
1½"	<b>UPPT150</b>
1¾"	<b>UPPT175</b>



Street Cleaning Nozzles

Feature:

- welded fabrication

Size	Connection	Aluminum Part #
2"	female cam	<b>200DBAL</b>
3"	female cam	<b>300DBAL</b>



U.S. Coast Guard Approved AFFF / Water Fog Nozzles

Fire Fittings & Accessories



CGSN150F

**Application:**

- designed for maximum efficiency with AFFF (Aqueous Film Forming Foams) or water on shipboard, offshore rigs and industrial applications

**Features:**

- corrosion resistant brass construction
- rubber-like bumper and handle for added protection
- Zytel (nylon) horseshoe handle
- double row of molded teeth for excellent fog pattern
- flush without shutting down
- constant gallonage in all fog and straight stream patterns
- combination fog and straight stream
- maximum operating pressure: **100 PSI** (water/AFFF only) at **70°F (21°C)**



CGSN151F

Thread NST (NH)	Description	Fog Flow GPM @100 PSI	Approval #	Brass Part #
1½"	nozzle	<b>95</b>	162.027/13/0	<b>CGSN150F</b>
	nozzle w/pistol grip	<b>95</b>	162.027/14/0	<b>CGSN151F</b>

- Gaskets are special order, please call 877.712.6179 for assistance.

Thread NPSH	Description	Fog Flow GPM @100 PSI	Brass Part #
1½"	nozzle	<b>95</b>	<b>CGSN150S</b>
	nozzle w/pistol grip	<b>95</b>	<b>CGSN151S</b>

U.S. Coast Guard Approved Fog Nozzles

**Application:**

- designed to US Coast Guard specifications for fighting fires with drafted water, required equipment for all commercial vessels under US registry

**Features:**

- maximum operating pressure: **100 PSI** (water/AFFF only) at **70°F (21°C)**
- corrosion resistant brass construction
- combination fog and straight stream for shipboard fire fighting
- applicator tips are available, consult Dixon® for pricing and availability



Thread	Fog Flow GPM @100 PSI	Cast Brass Part #
1½" NST	55	<b>CGN150NST</b>
2½" NST	108	<b>CGN250NST</b>

- Gaskets and tips are special order, please call 877.712.6179 for assistance.

## Omega™ Monitor



**Features:**

- cast-in turning vanes for a more efficient flow
- 360° horizontal and 150° vertical travel
- friction loss: **10 PSI at 800 GPM** (.7 bar at 3030 LPM)
- 4 bolt hole pattern on flange
- Factory Mutual approved

Size	Inlet	Outlet	Waterway	Flow	Brass Part #
17" x 11½"	3" flange	2½" MNST	3"	1250 GPM	<b>AK3526-300FL</b>

- For flange dimensions, diagrams and additional information please reference dixonvalve.com.



Fire Fittings & Accessories

## Monitor Nozzle

**Features:**

- fixed teeth
- combination Straight, Stream and Fog - no shutoff
- fixed gallonage master stream nozzle
- factory set at **500 GPM** (1900 lpm) field changeable to **300** or **700 GPM** (1140 or 2660 LPM)
- maximum operating pressure: **100 PSI** (water only)

Size	Thread	90° Spray GPM @ 100 PSI	Brass Part #
2½"	NST (NH)	500	<b>AK4450NST</b>

- Gaskets are special order, please call 877.712.6179 for assistance.



## FirePro™ Monitor



**Features:**

- seamless 2½" monitor - rated at 750 GPM
- carbon steel construction, stainless steel discharge tip and ball bearings
- 360° horizontal and 140° vertical travel
- red epoxy finish standard
- 150# ASA raised face 4" flange
- Factory Mutual approved

Size	Inlet	Outlet	Waterway	Flow GPM	Carbon Steel Part #
22" x 13"	4" flange	2½" MNST	2½"	<b>750</b>	<b>FP475S</b>

- Gaskets are special order, please call 877.712.6179 for assistance.
- For flange dimensions, diagrams and additional information please reference dixonvalve.com.



## Master Stream Nozzles

**Features:**

- factory set at **500 GPM**
- featuring a straight stream to fog 'quick throw' pattern change
- constant gallonage

Size	Thread	Material	Part #
2½"	NST (NH)	brass	<b>FP500B<sup>1</sup></b>
	NST (NH)	aluminum	<b>FP500A</b>

<sup>1</sup> Factory Mutual approved

- Gaskets are special order, please call 877.712.6179 for assistance.





### Factory Mutual Approved Fog Nozzles

**Features:**

- brass stem with locking nut
- shutoff-straight-stream-fog
- wings on sleeve for ease of adjustment
- maximum operating pressure: **100 PSI** (water only) at **70°F (21°C)**
- Factory Mutual approved



with bumper



without bumper

Size	Thread	90° Spray GPM @ 100 PSI	Polycarbonate <sup>1</sup> Part #	Polycarbonate <sup>2</sup> Global Part #
3/4"	GHT	<b>30.9</b>	<b>SL075GHT<sup>3</sup></b>	---
3/4"	NPSH	<b>30.9</b>	<b>SL075<sup>3</sup></b>	---
1"	NPSH	<b>30.9</b>	<b>SL100<sup>3</sup></b>	<b>PFNB100S</b>
1 1/2"	NPSH	<b>75.0</b>	<b>SL150</b>	<b>PFNB150S</b>
1"	NST (NH)	<b>30.9</b>	<b>SL100NST</b>	---
1 1/2"	NST (NH)	<b>75.0</b>	<b>SL150NST</b>	<b>PFNB150NST</b>

<sup>1</sup> with bumper  
<sup>2</sup> without bumper  
<sup>3</sup> 120° spray on 3/4" and 1"

### Polycarbonate Electrical Fire All-Fog Nozzles

**Features:**

- opens and closes in a 30° fog pattern up to 120°- no straight stream
- maximum operating pressure: **100 PSI** (water only) at **70°F (21°C)**
- brass stem



Size	Thread	75° Spray GPM @ 100 PSI	Polycarbonate Part #
1 1/2"	NPS	<b>92</b>	<b>FNBE150S</b>
	NST (NH)	<b>92</b>	<b>FNBE150NST</b>

### Fog Nozzles Gaskets



Size	Thread	ID	OD	Thickness	Buna-N Part #
1"	NPSH	0.937"	1.234"	0.125"	<b>FNG100S</b>
1"	NPSH	1.000"	1.375"	0.125"	<b>HGG100S</b>
1 1/2"	NPSH	1.500"	1.827"	0.125"	<b>FNG150S</b>
1"	NST (NH)	0.937"	1.281"	0.125"	<b>FNG100NST</b>
1"	NST (NH)	1.000"	1.375"	0.125"	<b>HGG100NST</b>
1 1/2"	NST (NH)	1.510"	1.906"	0.125"	<b>FNG150NST</b>

- dimensions are nominal



## Constant Flow Fog Nozzles

**Features:**

- red polycarbonate with bumper and black plastic and steel stem
- provides consistent volume at any spray angle
- adjusts from straight stream to fog
- 1" and 1½" are ULC listed
- maximum operating pressure: **100 PSI** (water only) at **70°F (21°C)**

Size	Thread	90° Spray GPM @ 100 PSI	Polycarbonate Part #
¾"	GHT	<b>8</b>	<b>CFB75GHT</b>
1"	NPSH	<b>22</b>	<b>CFB100S</b>
1½"	NPSH	<b>75</b>	<b>CFB150S</b> <sup>1</sup>
1½"	NPSH	<b>150</b>	<b>HGCFB150S</b> <sup>2</sup>
2"	NPSH	<b>75</b>	<b>CFB2015S</b> <sup>1</sup>
2"	NPSH	<b>150</b>	<b>CFB200S</b> <sup>2</sup>
1"	NST (NH)	<b>22</b>	<b>CFB100NST</b>
1½"	NST (NH)	<b>75</b>	<b>CFB150NST</b> <sup>1</sup>
1½"	NST (NH)	<b>150</b>	<b>HGCFB150NST</b> <sup>2</sup>
2½"	NST (NH)	<b>150</b>	<b>CFB250NST</b> <sup>3</sup>
2½"	NST (NH)	<b>215</b>	<b>HGCFB250NST</b> <sup>2,4</sup>

- <sup>1</sup> standard flow
- <sup>2</sup> high flow
- <sup>3</sup> provided with handles

- gaskets located below
- NYF – New York Fire Dept. Thread 1½" (2.100 ODM X 8 TPI) — 2½" (3.030 ODM X 8 TPI)
- CF – Chicago Fire Dept. Thread 1½" (1.933 ODM X 11.5 TPI) — 2½" (2.990 ODM X 7.5 TPI)
- NYC – New York Corporation Thread 1½" (2.093 ODM X 11 TPI) — 2½" (3.000 ODM X 8 TPI)
- Also available CSA, BAT, NSS



2½" nozzle with handles



2½" nozzle without handles



1½" nozzle

## Blue Refinery Fog Nozzles

**Features:**

- blue polycarbonate with bumper and black plastic and steel stem
- glass-filled
- provides consistent volume at any spray angle
- adjusts from Straight Stream to Fog
- resistant to petrochemicals
- maximum operating pressure: **100 PSI** (water only) at **70°F (21°C)**

Size	Thread	90° Spray GPM @ 100 PSI	Polycarbonate Part #
1½"	NPSH	<b>75</b>	<b>RNB150S</b>
1½"	NST (NH)	<b>75</b>	<b>RNB150NST</b>



## Gaskets

**Application:**

- used on constant flow and refinery fog nozzles

Size	Thread	ID	OD	Thickness	Buna-N Part #
1"	NPSH	0.900"	1.270"	0.125"	<b>CFG100S</b>
1½"	NPSH	1.510"	1.878"	0.125"	<b>CFG150S</b>
2"	NPSH	1.680"	2.340"	0.156"	<b>CFG200S</b>
1"	NST (NH)	0.900"	1.270"	0.125"	<b>CFG100NST</b>
1½"	NST (NH)	1.510"	1.906"	0.125"	<b>CFG150NST</b>
2½"	NST (NH)	2.250"	3.000"	0.187"	<b>CFG250NST</b>

- dimensions are nominal



### TriFlow Fog Nozzles



**Features:**

- corrosion resistant plated aluminum
- combination 170° fog and straight stream
- Venturi flow improves straight stream and gallonage
- no nozzle teeth eliminates fingers and voids in the spray pattern thus producing a dense fog

Size	Thread	GPM @ 100 PSI Straight Stream	6061 T-6 Aluminum Part #
1½"	NST	<b>60-100-140</b>	<b>TFN150NST-140</b>
	NPSH	<b>60-100-140</b>	<b>TFN150-140</b>
1½"	NST	<b>75-150-200</b>	<b>TFN150NST-200</b>
	NPSH	<b>75-150-200</b>	<b>TFN150-200</b>

### Econo Fog Nozzles



**Features:**

- rugged, lightweight, corrosion resistant
- supplied without bumper
- for cabinet use, discourages theft
- for use up to 100 PSI (water only)

Size	Thread	Straight Stream @ 100 PSI	6061-T6 Aluminum Part #
1"	NPSH	56	<b>AFN100</b>
1"	NST	56	<b>AFN100NST</b>
1½"	NPSH	56	<b>AFN150</b>
1½"	NST	56	<b>AFN150NST</b>

### Heavy Duty Constant Flow Fog Nozzles



Size	Thread	Length	GPM @ 100 PSI	Fiberglass Reinforced Composite Part #
1½"	NPSH	5"	<b>95</b>	<b>CFFR150</b>
	NST (NH)	5"	<b>95</b>	<b>CFFR150NST</b>

### Garden Hose Nozzles



GHN75



GHN75-B

**Features:**

- offers two straight streams and one fog pattern <sup>1</sup>
- massive bumper specially formulated to resist damage and aging
- corrosion resistant hard coat

Size	Thread	GPM @ 40 PSI Straight Stream		6061-T6 Aluminum Part #
		1st	2nd	
¾"	GHT - without bumper	<b>1-2</b>	<b>3-4</b>	<b>GHN75</b>
	GHT - with bumper	<b>1-2</b>	<b>3-4</b>	<b>GHN75-B</b>

<sup>1</sup> fog pattern is **4-5 GPM @ 40 PSI**

## Break Apart Attack Nozzles

**Application:**

- low-cost, versatile, and easy-to-use nozzle for first responders in rural and suburban fire departments

**Features:**

- minimal training required to connect and operate the nozzle
- nozzle uses a 1½" coupler, provides **20-90 GPM** fog or straight stream flows at **100 PSI**
- nozzle can be separated from the shut off valve for extended hose lays and other uses
- meets or exceeds USDA Forestry Service standards

Size	Thread	Aluminum Part #
1"	NPSH	<b>ABN100S</b>
	NST (NH)	<b>ABN100F</b>
1½"	NPSH	<b>ABN150S</b>
	NST (NH)	<b>ABN150F</b>



## Ball Shut-Off Nozzles - Bolted Style

**Features:**

- rugged and lightweight
- pistol grip
- hardcoated female swivel inlet and male outlet
- maximum operating pressure: **200 PSI** (water only) at **70°F (21°C)**

Size	Thread	Waterway	Cast Aluminum Part #
1½"	NST (NH)	1⅜"	<b>ACPSO150F</b>
	NPSH	1⅜"	<b>ACPSO150</b>



## Pistol Grip Adapters

**Features:**

- converts any standard fog nozzle to a well-balanced, easy to hold pistol grip fog nozzle making the job of holding high pressure lines easier
- full-time ball bearing swivel base
- corrosion resistant
- hardcoated per MIL-A-8625-F TYPE 111, (Polylube 1)

Size	Thread	6061 T-6 Aluminum Part #
1"	NST	<b>PGA100NST</b>
1½"	NST	<b>PGA150NST</b>
	NPSH	<b>PGA150NPSH</b>
2½"	NST	<b>PGA250NST</b>



### Single Gallonage Shut-off Nozzles



**Features:**

- PTFE hard-coated for greater corrosion resistance and durability
- lightweight and easily maneuvered
- full-time ball bearing swivel base
- metal ball with non-stick Delrin® seats
- 1-1/16" waterway

Size	Thread	Constant GPM @ 100 PSI	Aluminum Part #
1"	NST	95	<b>BVSO100NST</b>
	NPSH	95	<b>BVSO100</b>
1½"	NST	95	<b>BVSO150NST</b>
	NPSH	95	<b>BVSO150</b>
	NST	125	<b>BVSO150NST-125</b>
	NPSH	125	<b>BVSO150-125</b>

### Dual Gallonage Shut-off Nozzles



**Features:**

- PTFE hard-coated for greater corrosion resistance and durability
- lightweight and easily maneuvered
- full-time ball bearing swivel base
- metal ball with non-stick Delrin® seats
- 1-1/16" waterway

Size	Thread	Constant GPM @ 100 PSI	Aluminum Part #
1"	NST	25 - 70	<b>BVDSO100NST</b>
	NPSH	25 - 70	<b>BVDSO100</b>
1½"	NST	25 - 70	<b>BVDSO150NST</b>
	NPSH	25 - 70	<b>BVDSO150</b>

### Adjustable Tri-Flo Selectable Gallonage Nozzles



**Features:**

- corrosion resistant plated with Neoprene bumper
- full-time ball bearing swivel base
- dense fog delivery with no voids or fingers in pattern
- metal ball with non-stick Delrin® seats

Size	Thread	Constant GPM @ 100 PSI	Aluminum Part #
1½"	NST	60 - 100 - 140	<b>BVTSO150NST</b>
	NPSH	60 - 100 - 140	<b>BVTSO150</b>
	NST	75 - 150 - 200	<b>BVTSO150NST-200</b>
	NPSH	75 - 150 - 200	<b>BVTSO150-200</b>
2½"	NST	100 - 200 - 300	<b>BVTSO250NST</b>

### Global Forestry Fog Nozzles



Size	Thread	GPM @ 100 PSI Straight Stream		Anodized Aluminum Part #
		1st	2nd	
1½"	NPSH	23.8	73.9	<b>GFN150</b>
	NST (NH)	37.6	95.0	<b>GFN150NST</b>

### Forestry Fog Nozzles

**Features:**

- maroon hard-coated barrel allows for easy identification
- corrosion resistant plated
- dual flow rate nozzles offer two straight stream and two fog patterns
- combination fog and straight stream
- maximum operating pressure: **600 PSI** (water only) at **70°F (21°C)**

Size	Thread	GPM @ 100 PSI Straight Stream		6061-T6 Aluminum Part #
		1st	2nd	
¾"	GHT	1-2	3-4 <sup>1</sup>	<b>FFN75GHT<sup>1</sup></b>
1"	NPSH	12	25	<b>FFN100<sup>2,4</sup></b>
1½"	NPSH	25	70	<b>FFN150</b>
1"	NST (NH)	12	25	<b>FFN100NST</b>
1½"	NST (NH)	25	70	<b>FFN150NST<sup>3,4</sup></b>

<sup>1</sup> GPM @ 40 PSI

<sup>2</sup> FFN100 meets USFS 5100-239A and NSN 4210-01-165-6603

<sup>3</sup> FFN150NST meets USFS 5100-107A and NSN 4210-01-167-1123

<sup>4</sup> both nozzles conform to Forestry Service specification 5100-239C and 5100-107a



FFN75GHT



FFN100

### Forestry Grade Ball Shut-Off Nozzles

**Features:**

- NFPA1964 compliant
- hardcoated threads, acetal ball and rigid inlet
- maximum operating pressure: **600 PSI** at ambient temperature **70°F (21°C)**
- FSS specification 5100-238

Size	Thread	Waterway	Anodized Aluminum Part #
1"	NPSH	¾"	<b>FBSO100S</b>
1½"	NPSH	1"	<b>FBSO150S</b>
1"	NST (NH)	¾"	<b>FBSO100F</b>
1½"	NST (NH)	1"	<b>FBSO150F</b>



### Forestry Grade Ball Shut-Off Pistol Grip

**Features:**

- NFPA1964 compliant
- hardcoated threads, acetal ball and full time live swivel inlet
- maximum operating pressure: **600 PSI** at ambient temperature **70°F (21°C)**
- FSS specification 5100-238

Size	Thread	Waterway	Anodized Aluminum Part #
1"	NPSH	¾"	<b>FBSO100S-PG</b>
1½"	NPSH	1"	<b>FBSO150S-PG</b>
1"	NST (NH)	¾"	<b>FBSO100F-PG</b>
1½"	NST (NH)	1"	<b>FBSO150F-PG</b>



### Ball Shut-Off Nozzles Tips

**Features:**

- lightweight
- maximum operating pressure: **200 PSI** (water only) at ambient temperature **70°F (21°C)**
- ½" orifice standard, other sizes available, contact Dixon®

Size	Thread	Length	Orifice	Anodized Aluminum Part #
1"	NPSH	4"	½"	<b>ANT100</b>
1½"	NPSH	4¾"	½"	<b>ANT150</b>
1"	NST (NH)	4"	½"	<b>ANT100F</b>
1½"	NST (NH)	4¾"	½"	<b>ANT150F</b>



NPSH



NST

- Gaskets are special order, please call 877.712.6179 for assistance.

Penetrator Nozzles



Features:

- designed with standard 1½" NPSH male hose threads that are converted to female thread for connection to the hose using a double female rigid connector
- ¼" discharge orifice generates a high velocity water jet that is effective against deep seated wildland fires
- maximum operating pressure: **200 PSI** (water only) at ambient temperature **70°F (21°C)**

Size	Thread	Length	Orifice	Polycarbonate Part #
1½"	NPSH	5½"	¼"	<b>PFN4005S</b>
	NST (NH)	5½"	¼"	<b>PFN4005F</b>

Twin Tip Straight Stream Forestry Nozzles



Features:

- molded high strength red polycarbonate
- solid, one-piece reversible twin tip has ¼" and ⅜" orifices
- maximum operating pressure: **100 PSI** (water only) at ambient temperature **70°F (21°C)**

Size	Thread	Length with tip	Length without tip	Orifice of base nozzle	Polycarbonate Part #
1½"	NPSH	9"	7½"	½"	<b>PTTF150S</b>
	NST (NH)	9"	7½"	½"	<b>PTTF150F</b>

Ball Shut-Off with Nozzle



FNPSO150F-30

FNPSO150S-30

Features:

- flexible design allows nozzle tip to be detached so a mating foam inductor can be inserted between the tip and shut-off valve
- lightweight
- black pistol grip shutoff with nozzle
- maximum operating pressure: **150 PSI** (water / AFFF only) at **70°F (21°C)**

Size	Body Color	Thread	GPM	Polycarbonate Part #
1½"	red	NPSH	30	<b>FNPSO150S-30</b>
	orange	NST (NH)	30	<b>FNPSO150F-30</b>
1½"	red	NPSH	70	<b>FNPSO150S-70</b>
	orange	NST (NH)	70	<b>FNPSO150F-70</b>

Ball Shut-Off Pistol Grips



Features:

- lightweight
- maximum operating pressure: **150 PSI** (water or AFFF only) at ambient temperature **70°F (21°C)**

Size	Thread	Polycarbonate Part #
1½"	NPSH	<b>PPSO150S</b>
	NST (NH)	<b>PPSO150F</b>

### Adjust-A-Power Nozzle

**Features:**

- ideal for patio, auto and boat, driveway and garden
- produces 50% more power than twist nozzles
- does not require a washer
- leave nozzle in the open position when not in use
- brass construction with stainless steel bearings
- maximum operating pressure: **100 PSI** (water only) at ambient temperature **70°F (21°C)**



Thread Size	Brass Part #
3/4" GHT	<b>AAPN75GHT</b>

### Constant Flow Nozzle Displays

**Features:**

- shatterproof and UV resistant polycarbonate withstands tough environmental conditions
- seals used for true water shut off
- easy twist spray pattern adjustment
- sold in case quantity only (25 per case), with display



Thread	45° Spray GPM @ 100 PSI	Color	Global Part #
3/4" GHT	25.1	green	<b>FNB75GHT-GD</b>
	25.1	clear	<b>CNB75GHT-GD</b>

### Constant Flow Nozzles with Bumper

**Feature:**

- can be used as a replacement nozzle in the display case **FNB75GHT-GD**



Thread	45° Spray GPM @ 100 PSI	Color	Plastic Part #
3/4" GHT	8.0	green	<b>GNB75GHT</b> (domestic)
	25.1	clear	<b>CNB75GHT</b> (global)

### Double Female Hex Adapters

**Feature:**

- other configurations are available, consult Dixon® for information



Female Thread	Female NST (NH) Thread	Cast Brass Part #
1½" NPT	1½"	<b>FFH1515F</b>
2½" NPT	2½"	<b>FFH2525F</b>
1½" NST (NH)	1½"	<b>FFH15F15F</b>
2½" NST (NH)	2½"	<b>FFH25F25F</b>

Female Thread	Female NYFD	Cast Brass Part #
1½" NYFD	1½"	<b>FFH15NYFD15NYFD</b>
1½" NPT	1½"	<b>FFH1515NYFD</b>
2½" NPT	2½"	<b>FFH2525NYFD</b>

Female Thread	Female Thread	Cast Brass Part #
1½" NPT	1½" NPSH	<b>FFH15T15S</b>

### Female Rocker Lug - Suction Adapter with Poly Screen



**Feature:**

- suction intake with strainer screen

Female NST (NH) Thread	Female NPT Thread	Cast Brass Part #
2½"	1½"	<b>RSFSA25F15T</b>
	2"	<b>RSFSA25F20T</b>
	2½"	<b>RSFSA250F</b>
	3"	<b>RSFSA25F30T</b>

- All adapters are made to approved Dixon® specifications.
- Replacement washers can be found on page 785



(Open Snoot) Female Swivel Adapters - Pin Lug

**Features:**

- double female rigid hexagon to swivel connection, rigid end thread is always NPT, hose thread is on swivel end
- finishes: -P polished, -C polished chrome plated
- other configurations are available, consult Dixon® for information

Female Swivel Thread	Female Rigid Thread	Cast Brass Part #
1½" NST (NH)	1½" NPT	<b>SF150F</b>
1½" NPSH	1½" NPT	<b>SF150S</b>
2½" NST (NH)	1½" NPT	<b>SF25F15T</b>
2½" NST (NH)	2" NPT	<b>SF25F20T</b>
2½" NYFD	2½" NPT	<b>SF250NYFD</b>
2½" NST (NH)	2½" NPT	<b>SF250F</b>
2½" NST (NH)	2½" NPT	<b>SF250F-P</b>
2½" NST (NH)	2½" NPT	<b>SF250F-C</b>
2½" NPSH	2½" NPT	<b>SF250S</b>
2½" NST (NH)	3" NPT	<b>SF25F30T</b>
3" NST (NH)	3" NPT	<b>SF300F</b>
3" NYFD	3" NPT	<b>SF300NYFD</b>
4" NST (NH)	4" NPT	<b>SF400F</b>



Domestic Female Swivel Adapters - Pin Lug

**Feature:**

- other configurations are available, consult Dixon® for information

Female NST (NH) Swivel Thread	Female Rigid NPT Thread	Cast Brass Part #
1½"	1½"	<b>SF150F-D</b>
2½"	2½"	<b>SF250F-D</b>
	2"	<b>SF25F20T-D</b>



(Open Snoot) Female Swivel Adapters - Rocker Lug

**Feature:**

- other configurations are available, consult Dixon® for information

Female NST (NH) Thread	Female Rigid NPT Thread	Cast Brass Part #
1½"	1½"	<b>RSF150F</b>
2½"	1½"	<b>RSF25F15T</b>
	2"	<b>RSF25F20T</b>
	2½"	<b>RSF250F</b>
	3"	<b>RSF25F30T</b>



- All adapters are made to approved Dixon® specifications.
- Replacement washers can be found on page 785

Double Female Swivels  
Pin Lug



Female NPSH Thread	Female NPSH Thread	Cast Brass Part #
1½"	1½"	<b>DFP1515</b>
2½"	2½"	<b>DFP2525</b>

Female NST (NH) Thread	Female NST (NH) Thread	Cast Brass Part #
1½"	1½"	<b>DFP1515F</b>
2½"	2½"	<b>DFP2525F</b>

Female NST (NH) Thread	Female NPSH Thread	Cast Brass Part #
1½"	1½"	<b>DFP15F15S</b>
2½"	2½"	<b>DFP25F25S</b>

Female NYFD Thread	Female NYFD Thread	Cast Brass Part #
1½"	1½"	<b>DFP15NYFD15NYFD</b>
2½"	2½"	<b>DFP25NYFD25NYFD</b>

Rocker Lug



Female NPSH Thread	Female NPSH Thread	Cast Brass Part #
1½"	1½"	<b>DFR1515</b>
2½"	2½"	<b>DFR2525</b>

Female NST (NH) Thread	Female NST (NH) Thread	Cast Brass Part #
1½"	1½"	<b>DFR1515F</b>
2½"	2½"	<b>DFR2525F</b>

Domestic Double Female Swivels - Pin Lug



Female NST (NH) Thread	Female NST (NH) Thread	Cast Brass Part #
1½"	1½"	<b>DFP1515F-D</b>
2½"	2½"	<b>DFP2525F-D</b>

- Replacement washers can be found on page 785

Aluminum Swivel Female x Rigid Female Adapters - Rocker Lug Style N53

Female NPSH Swivel Thread	Female Rigid NPT Thread	Aluminum Extrusion - Anodized Part #
1½"	1½"	<b>N53-15S15T</b>
2"	2"	<b>N53-20S20T</b>
3"	3"	<b>N53-30S30T</b>
6"	6"	<b>N53-60S60T</b>



Female NPSH Swivel Thread	Female Rigid NPSH Thread	Aluminum Extrusion - Anodized Part #
1½"	1½"	<b>N53-15S15S</b>



Female NST (NH) Swivel Thread	Female Rigid NPT Thread	Aluminum Extrusion - Anodized Part #
1½"	1½"	<b>N53-15F15T</b>
2½"	2"	<b>N53-25F20T</b>
	2½"	<b>N53-25F25T</b>
	3"	<b>N53-25F30T</b>
4"	4"	<b>N53-25F40T</b>
	4"	<b>N53-40F40T</b>
4½"	4"	<b>N53-45F40T</b>
	6"	<b>N53-45F60T</b>
5"	6"	<b>N53-50F60T</b>
6"	6"	<b>N53-60F60T</b>



Female NST (NH) Swivel Thread	Female Rigid NST Thread	Aluminum Extrusion - Anodized Part #
1½"	1½"	<b>N53-15F15F</b>
2½"	1½"	<b>N53-25F15F</b>
	2½"	<b>N53-25F25F</b>
	6"	<b>N53-25F60F</b>
4"	4"	<b>N53-40F40F</b>
6"	4½"	<b>N53-60F45F</b>



- All adapters are made to approved Dixon® specifications.
- Replacement washers can be found on page 785

Double Swivel Female Adapters - Rocker Lug  
Style N35

Fire Fittings & Accessories



Female NPSH Swivel Thread	Female NPSH Swivel Thread	Aluminum Extrusion - Anodized Part #
1"	1"	<b>N35-10S10S</b>
1½"	1½"	<b>N35-15S15S</b>
2½"	2½"	<b>N35-25S25S</b>
3"	3"	<b>N35-30S30S</b>



Female NST (NH) Swivel Thread	Female NST (NH) Swivel Thread	Aluminum Extrusion - Anodized Part #
1"	1"	<b>N35-10F10F</b>
1½"	1½"	<b>N35-15F15F</b>
	2½"	<b>N35-15F25F</b>
2½"	2½"	<b>N35-25F25F</b>
4"	4"	<b>N35-40F40F</b>
4½"	4½"	<b>N35-45F45F</b>
5"	5"	<b>N35-50F50F</b>
6"	6"	<b>N35-60F60F</b>



Female NPSH Swivel Thread	Female NST Swivel Thread	Aluminum Extrusion - Anodized Part #
1"	1"	<b>N35-10S10F</b>
	1½"	<b>N35-10S15F</b>
1½"	1½"	<b>N35-15S15F</b>
2"	2½"	<b>N35-20S25F</b>
2½"	2½"	<b>N35-25S25F</b>

Aluminum Double Female Swivel Adapters - Long Handle  
Style N57



Female NST (NH) Thread	Male NST (NH) Thread	Aluminum Extrusion - Anodized Part #
4½"	6"	<b>N57-45F60F</b>
5"	5"	<b>N57-50F50F</b>
	6"	<b>N57-50F60F</b>
6"	6"	<b>N57-60F60F</b>

- All adapters are made to approved Dixon® specifications.
- Replacement washers can be found on page 785

Hydrant Adapters - Pin Lug

Feature:

- other configurations are also available, consult Dixon® for information

Female Thread	Male Thread	Cast Brass Part #
1½" NPSH	¾" GHT	HA15S76
	¾" NPSH	HA15S75
	¾" NPT	HA15S75T
	1" NPSH	HA15S10S
	1" NPT	HA15S10T
	1½" NPT	HA15S15T
	1½" NST (NH)	HA15S15F
1½" NPT	1½" NPSH	HA15T15S
	1½" NST (NH)	HA15T15F
1½" NST (NH)	¾" GHT	HA1576
	¾" NPSH	HA1575
	¾" NPT	HA1575T
	1" NPSH	HA1510
	1" NST (NH)	HA1510F
	1" NPT	HA1510T
	1½" NPSH	HA1515
	1½" NPT	HA1515T
	1½" NST (NH)	HA1515F
	2½" NST (NH)	HA1525F
2" NPSH	1½" NPSH	HA20S15S
	1½" NPT	HA20S15T
	1½" NST (NH)	HA20S15F
	2½" NST (NH)	HA20S25F
2" NPT	2½" NST (NH)	HA20T25F
2" NST (NH)	2½" NST (NH)	HA2025F
2½" NPSH	1" NPT	HA25S10T
	1½" NPSH	HA25S15S
	1½" NPT	HA25S15T
	1½" NST (NH)	HA25S15F
	2½" NST (NH)	HA25S25F
2½" NST (NH)	¾" GHT	HA2576
	¾" NPT	HA2575T
	1" NPSH	HA2510
	1" NST (NH)	HA2510F
	1" NPT	HA2510T
	1½" NPSH	HA2515
	1½" NST (NH)	HA2515F
	1½" NPT	HA2515T
	2" NPSH	HA2520
	2" NST (NH)	HA2520F
	2" NPT	HA2520T
	2½" NPSH	HA2525
	2½" NST (NH)	HA2525F
	2½" NPT	HA2525T
	3" NPSH	HA2530
3" NST (NH)	HA2530F	
3" NPT	HA2530T	
3" NPSH	2½" NST (NH)	HA30S25F
	2½" NPT	HA30S25T
3" NST (NH)	1½" NPSH	HA3015S
	1½" NST (NH)	HA3015F
	2½" NST (NH)	HA3025F
4" NST (NH)	2½" NST (NH)	HA4025F
4½" NST (NH)	2½" NST (NH)	HA4525F



reducer



same size



increaser

- All adapters are made to approved Dixon® specifications.
- Replacement washers can be found on page 785

Hydrant Adapters - Rocker Lug

Features:

- finishes: -C polished chrome plated
- other configurations are also available, consult Dixon® for information

Fire Fittings & Accessories



reducer



reducer - chrome plated



same size

Female Thread	Male Thread	Cast Brass Part #
1½" NST (NH)	¾" NST (NH)	<b>RHA1576</b>
	1" NST (NH)	<b>RHA1510</b>
	1" NST (NH)	<b>RHA1510F</b>
	1" NPT	<b>RHA1510T</b>
	1½" NPSH	<b>RHA1515</b>
	1½" NST (NH)	<b>RHA1515F</b>
	1½" NPT	<b>RHA1515T</b>
	2" NPSH	<b>RHA1520</b>
	2½" NST (NH)	<b>RHA1525F</b>
	1½" NPSH	¾" NPT
1" NPSH		<b>RHA15S10</b>
1" NPT		<b>RHA15S10T</b>
1½" NST (NH)		<b>RHA15S15F</b>
1½" NPT		<b>RHA15S15T</b>
1½" NPT	1½" NST (NH)	<b>RHA15T15F</b>
2" NST (NH)	2½" NST (NH)	<b>RHA2025F</b>
2½" NST (NH)	¾" GHT	<b>RHA2576</b>
	1" NPSH	<b>RHA2510</b>
	1" NST (NH)	<b>RHA2510F</b>
	1" NPT	<b>RHA2510T</b>
	1½" NPSH	<b>RHA2515</b>
	1½" NST (NH)	<b>RHA2515F</b>
	1½" NPT	<b>RHA2515T</b>
	2" NST (NH)	<b>RHA2520F</b>
	2" NPT	<b>RHA2520T</b>
	2½" NPT	<b>RHA2525T</b>
3" NPT	<b>RHA2530T</b>	
2½" NPSH	1½" NPSH	<b>RHA25S15</b>
	1½" NST (NH)	<b>RHA25S15F</b>
2½" NPT	2½" NST (NH)	<b>RHA25T25F</b>
3" NST (NH)	2½" NST (NH)	<b>RHA3025F</b>

Female x Male Adapters - Long Handle Style N56



Female NST (NH) Thread	Male NST (NH) Thread	Aluminum Extrusion - Anodized Part #
4"	2½"	<b>N56-40F25F</b>
4½"	4"	<b>N56-45F40F</b>
5"	2½"	<b>N56-50F25F</b>
6"	4½"	<b>N56-60F45F</b>
	6"	<b>N56-60F60T<sup>1</sup></b>

<sup>1</sup> female NST (NH) x male NPT

- All adapters are made to approved Dixon® specifications.
- Replacement washers can be found on page 785

## Hydrant Adapters - Pin Lugs (New York Threads)

**Features:**

- NYFD thread = 3.031 x 8 TPI
- NYC thread = 3.00 x 8 TPI
- other configurations are also available, consult Dixon® for information

Female NYFD Thread	Male Thread	Cast Brass Part #
1½"	¾" GHT	<b>HA15NYFD76</b>
2½"	¾" NPT	<b>HA25NYFD75T</b>
	¾" GHT	<b>HA25NYFD76</b>
	1½" NPSH	<b>HA25NYFD15S</b>
	1½" NST (NH)	<b>HA25NYFD15F</b>
	1½" NPT	<b>HA25NYFD15T</b>
	1½" NYFD	<b>HA25NYFD15NYFD</b>
	2" NPT	<b>HA25NYFD20T</b>
	2½" NST (NH)	<b>HA25NYFD25F</b>

Female NYC Thread	Male Thread	Cast Brass Part #
2½"	¾" GHT	<b>HA25NYC76</b>
	1" NPT	<b>HA25NYC10T</b>
	1½" NPT	<b>HA25NYC15T</b>
	2" NPT	<b>HA25NYC20T</b>



reducer



same size



increaser

## Hazmat Adapters - Pin Lugs

**Feature:**

- divides single stream into double stream

Female NST Thread	Male Thread	Cast Brass Part #
1½"	(2) ¾" GHT	<b>HHA1576</b>
2½"	(2) ¾" GHT	<b>HHA2576</b>



## Domestic Hydrant Adapters - Pin Lug

**Feature:**

- other configurations are available, consult Dixon® for information

Female NST (NH) Thread	Male Thread	Cast Brass Part #
1½"	¾" GHT	<b>HA1576-D</b>
2½"	1" NPT	<b>HA2510T-D</b>
	1½" NST (NH)	<b>HA2515F-D</b>
	1½" NPT	<b>HA2515T-D</b>
	¾" GHT	<b>HA2576-D</b>



- All adapters are made to approved Dixon® specifications.
- Replacement washers can be found on page 785

## Hydrant Adapters - Rocker Lug

**Features:**

- use with water
- maximum working pressure: **100 PSI at 70°F (21°C)**

Female Thread	Male Thread	Polycarbonate Part #
1½" NPSH	1½" NST (NH)	<b>POLYHA15S15F</b>
2½" NST (NH)	¾" GHT	<b>POLYHA2576</b>
	1½" NPSH	<b>POLYHA2515</b>
	1½" NST (NH)	<b>POLYHA2515F</b>
	2" NPT	<b>POLYHA2520T</b>

Fire Fittings & Accessories



## Domestic Female to Male Hex Nipples

**Feature:**

- other configurations are available, consult Dixon® for information

Female Thread	Male Thread	Cast Brass Part #
1" NPT	1½" NST (NH)	<b>FM1015F-D</b>
1½" NPT	1½" NST (NH)	<b>FM1515F-D</b>
	2½" NST (NH)	<b>FM1525F-D</b>
1½" NST (NH)	1½" NPSH	<b>FM15F15S-D</b>
	1½" NPT	<b>FM15F15T-D</b>
	2½" NST (NH)	<b>FM15F25F-D</b>
1½" NPSH	1½" NST (NH)	<b>FM15S15F-D</b>
	1½" NPT	<b>FM15S15T-D</b>
2" NPT	1½" NST (NH)	<b>FM2015F-D</b>
2½" NPT	2½" NST (NH)	<b>FM2525F-D</b>
2½" NST (NH)	1½" NST (NH)	<b>FM25F15F-D</b>
	1½" NPT	<b>FM25F15T-D</b>
	2½" NPT	<b>FM25F25T-D</b>



reducer



same size



increaser

- All adapters are made to approved Dixon® specifications.
- Replacement washers can be found on page 785



Single Male Outlet with Hex (open snoot)

**Application:**

- used to connect fire hose to a standpipe or sprinkler system

**Features:**

- finishes: -P polished, -C polished chrome plated
- other sizes, threads and configurations are available, consult Dixon® for information

Female NPT Thread	Male Thread	Cast Brass Part #
2½"	2½" NST (NH)	<b>MOC250F-P</b>
	2½" NST (NH)	<b>MOC250F-C</b>
3"	2½" NST (NH)	<b>MOC3025F-P</b>
	2½" NST (NH)	<b>MOC3025F-C</b>
	3" NST (NH)	<b>MOC300F-P</b>
Female NPT Thread	Male Thread	Cast Brass Part #
2½"	2½" NYC	<b>MOC250NYC-P</b>
	2½" NYFD	<b>MOC250NYFD-P</b>



polished



polished chrome plated

Fire Fittings & Accessories

Female to Male Hex Nipples

**Feature:**

- other configurations are also available, consult Dixon® for information

Female Thread	Male Thread	Cast Brass Part #
¾" GHT	1" NPT	<b>FM7610T</b>
1" NPSH	¾" GHT	<b>FM10S76</b>
	¾" GHT	<b>FM1076</b>
1" NPT	1" NPSH	<b>FM1010</b>
	1" NST (NH)	<b>FM1010F</b>
	1½" NPSH	<b>FM1015</b>
	1½" NST (NH)	<b>FM1015F</b>
1" NST (NH)	1" NPT	<b>FM10F10T</b>
1½" NPT	1½" NPSH	<b>FM1515</b>
	1½" NST (NH)	<b>FM1515F</b>
	2½" NST (NH)	<b>FM1525F</b>
1½" NST (NH)	1½" NPSH	<b>FM15F15S</b>
	1½" NPT	<b>FM15F15T</b>
	2" NPT	<b>FM15F20T</b>
	2½" NPT	<b>FM15F25T</b>
	2½" NST (NH)	<b>FM15F25F</b>
	1½" NST (NH)	<b>FM15F15F</b>
1½" NPSH	1½" NST (NH)	<b>FM15S15F</b>
	1½" NPT	<b>FM15S15T</b>
	2" NPT	<b>FM15S20T</b>
2" NPSH	1½" NPSH	<b>FM20S15</b>
	1½" NST (NH)	<b>FM20S15F</b>
	1½" NPT	<b>FM20S15T</b>
	2" NPT	<b>FM20S20T</b>
	2½" NST (NH)	<b>FM20S25F</b>
2" NPT	1½" NPSH	<b>FM2015</b>
	1½" NST (NH)	<b>FM2015F</b>
	2" NPSH	<b>FM2020</b>
	2½" NST (NH)	<b>FM2025F</b>
2½" NST (NH)	¾" NPT	<b>FM25F75T</b>
	1" NPT	<b>FM25F10T</b>
	1½" NST (NH)	<b>FM25F15F</b>
	1½" NPT	<b>FM25F15T</b>
	2" NPT	<b>FM25F20T</b>
2½" NPT	1½" NST (NH)	<b>FM2515F</b>
	2½" NPSH	<b>FM2525</b>
	2½" NST (NH)	<b>FM2525F</b>



reducer



same size

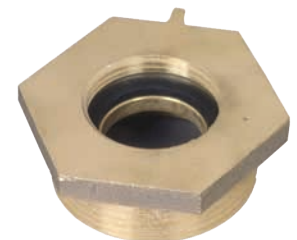

increaser

Table continued on next page

- All adapters are made to approved Dixon® specifications.
- Replacement washers can be found on page 785

### Female to Male Hex Nipples

Table continued from previous page

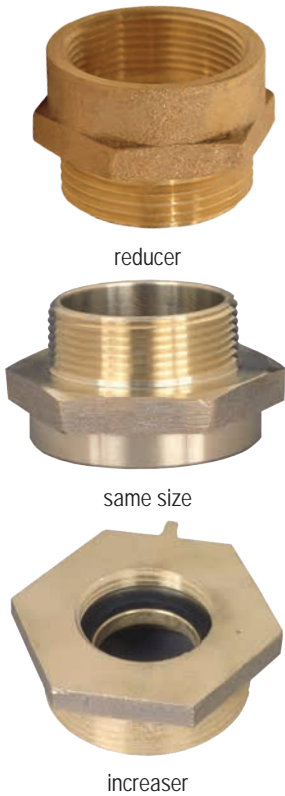

Female Thread	Male Thread	Cast Brass Part #
2½" NST (NH)	2½" NST (NH)	<b>FM25F25F</b>
	2½" NPT	<b>FM25F25T</b>
	3" NST (NH)	<b>FM25F30F</b>
	3" NPT	<b>FM25F30T</b>
	2½" NPSH	<b>FM25F25S</b>
2½" NPT	2½" NPT	<b>FM2525T</b>
2½" NPSH	2½" NST (NH)	<b>FM25S25F</b>
	2½" NPT	<b>FM25S25T</b>
3" NPT	2½" NST (NH)	<b>FM3025F</b>
	2½" NPT	<b>FM3025T</b>
	3" NST (NH)	<b>FM3030F</b>
3" NST (NH)	2½" NST (NH)	<b>FM30F25F</b>
	2½" NPT	<b>FM30F25T</b>
	3" NPT	<b>FM30F30T</b>
3" NPSH	2½" NST (NH)	<b>FM30S25F</b>
4" NPT	2½" NST (NH)	<b>FM4025F</b>
	4" NST (NH)	<b>FM4040F</b>
	4½" NST (NH)	<b>FM4045F</b>
4" NST (NH)	4" NPT	<b>FM40F40T</b>
4½" NST (NH)	4" NPT	<b>FM45F40T</b>
6" NPT	6" NST (NH)	<b>FM6060F</b>
6" NST (NH)	6" NPT	<b>FM60F60T</b>

### Female to Male Hex Nipples (New York Threads)

**Features:**

- NYFD thread = 3.031 x 8 TPI
- NYC thread = 3.00 x 8 TPI
- other configurations are available, consult Dixon® for information



Female Thread	Male Thread	Cast Brass Part #
1½" NPT	1½" NYFD	<b>FM1515NYFD</b>
1½" NST (NH)	1½" NYFD	<b>FM15F15NYFD</b>
1½" NYFD	1½" NST (NH)	<b>FM15NYFD15F</b>
	1½" NPT	<b>FM15NYFD15T</b>
Female Thread	Male Thread	Cast Brass Part #
2½" NPT	2½" NYC	<b>FM2525NYC</b>
	2½" NYFD	<b>FM2525NYFD</b>
2½" NST (NH)	2½" NYC	<b>FM25F25NYC</b>
	2½" NYFD	<b>FM25F25NYFD</b>
2½" NYC	2½" NST (NH)	<b>FM25NYC25F</b>
	2½" NPT	<b>FM25NYC25T</b>
2½" NYFD	2½" NST (NH)	<b>FM25NYFD25F</b>
	2½" NPT	<b>FM25NYFD25T</b>
Female NYFD Thread	Male Thread	Cast Brass Part #
2½"	1½" NPT	<b>FM25NYFD15T</b>
	2" NPT	<b>FM25NYFD20T</b>
	3" NPT	<b>FM25NYFD30T</b>

- All adapters are made to approved Dixon® specifications.
- Replacement washers can be found on page 785

Female x Male Adapters - Rocker Lug  
Style N37

Female Thread	Male Thread	Aluminum Extrusion - Anodized Part #
3/4" GHT	1" NST (NH)	<b>N37-07G10F</b>
	1" NPSH	<b>N37-07G10S</b>
	1" NPT	<b>N37-07G10T</b>
	1 1/2" NST (NH)	<b>N37-07G15F</b>
	1 1/2" NPSH	<b>N37-07G15S</b>
1" NST	3/4" GHT	<b>N37-10F07G</b>
	1" NPSH	<b>N37-10F10S</b>
	1" NPT	<b>N37-10F10T</b>
	1 1/2" NST (NH)	<b>N37-10F15F</b>
	1 1/2" NPSH	<b>N37-10F15S</b>
	2 1/2" NST (NH)	<b>N37-10F25F</b>
1" NPSH	3/4" GHT	<b>N37-10S07G</b>
	3/4" NPSH	<b>N37-10S07S</b>
	1" NST (NH)	<b>N37-10S10F</b>
	1" NPT	<b>N37-10S10T</b>
	1 1/2" NST (NH)	<b>N37-10S15F</b>
	1 1/2" NPSH	<b>N37-10S15S</b>
1" NPT	1" NST	<b>N37-10T10F</b>
1 1/2" NST (NH)	3/4" GHT	<b>N37-15F07G</b>
	3/4" NPT	<b>N37-15F07T</b>
	1" NST (NH)	<b>N37-15F10F</b>
	1" NPSH	<b>N37-15F10S</b>
	1" NPT	<b>N37-15F10T</b>
	1 1/2" NST (NH)	<b>N37-15F15F</b>
	1 1/2" NPSH	<b>N37-15F15S</b>
	1 1/2" NPT	<b>N37-15F15T</b>
	2" NPT	<b>N37-15F20T</b>
	2 1/2" NST (NH)	<b>N37-15F25F</b>
1 1/2" NPSH	3/4" GHT	<b>N37-15S07G</b>
	1" NST (NH)	<b>N37-15S10F</b>
	1 1/2" NST (NH)	<b>N37-15S15F</b>
	1 1/2" NPT	<b>N37-15S15T</b>
	2" NPT	<b>N37-15S20T</b>
1 1/2" NPT	1 1/2" NST (NH)	<b>N37-15T15F</b>
	1 1/2" NPSH	<b>N37-15T15S</b>
	2 1/2" NST (NH)	<b>N37-15T25F</b>
2" NPSH	3/4" GHT	<b>N37-20S07G</b>
	1 1/2" NST (NH)	<b>N37-20S15F</b>
	1 1/2" NPSH	<b>N37-20S15S</b>
	2" NPT	<b>N37-20S20T</b>
	2 1/2" NST (NH)	<b>N37-20S25F</b>
2" NPT	1 1/2" NST (NH)	<b>N37-20T15F</b>
	1 1/2" NPSH	<b>N37-20T15S</b>
	2 1/2" NST (NH)	<b>N37-20T25F</b>



reducer



same size



increaser

Table continued on next page

- All adapters are made to approved Dixon® specifications.
- Replacement washers can be found on page 785

Female x Male Adapters - Rocker Lug (continued)  
Style N37

Table continued from previous page

Female Thread	Male Thread	Aluminum Extrusion - Anodized Part #
2½" NST (NH)	¾" GHT	<b>N37-25F07G</b>
	¾" NPT	<b>N37-25F07T</b>
	1" NPT	<b>N37-25F10T</b>
	1½" NST (NH)	<b>N37-25F15F</b>
	1½" NPSH	<b>N37-25F15S</b>
	1½" NPT	<b>N37-25F15T</b>
	2" NPT	<b>N37-25F20T</b>
	2½" NST (NH)	<b>N37-25F25F</b>
	2½" NPSH	<b>N37-25F25S</b>
	2½" NPT	<b>N37-25F25T</b>
	3" NST (NH)	<b>N37-25F30F</b>
3" NPT	<b>N37-25F30T</b>	
2½" NPSH	1½" NPSH	<b>N37-25S15S</b>
	2½" NST (NH)	<b>N37-25S25F</b>
	2½" NPT	<b>N37-25S25T</b>
2½" NPT	1½" NPSH	<b>N37-25T15S</b>
	2½" NST (NH)	<b>N37-25T25F</b>
	3" NPT	<b>N37-25T30T</b>
3" NST (NH)	1½" NST (NH)	<b>N37-30F15F</b>
	2½" NST (NH)	<b>N37-30F25F</b>
	3" NPT	<b>N37-30F30T</b>
	2½" NST (NH)	<b>N37-30S25F</b>
3" NPT	2½" NST (NH)	<b>N37-30T25F</b>
	2½" NPT	<b>N37-30T25T</b>
4" NST (NH)	2½" NST (NH)	<b>N37-40F25F</b>
	4" NST (NH)	<b>N37-40F40F</b>
	4" NPT	<b>N37-40F40T</b>
	6" NST (NH)	<b>N37-40F60F</b>
4" NPT	2½" NST (NH)	<b>N37-40T25F</b>
	4" NST (NH)	<b>N37-40T40F</b>
	4½" NST (NH)	<b>N37-40T45F</b>
4½" NST (NH)	2½" NST (NH)	<b>N37-45F25F</b>
	4" NST (NH)	<b>N37-45F40F</b>
	4" NPT	<b>N37-45F40T</b>
	5" NST (NH)	<b>N37-45F50F</b>
5" NST (NH)	4½" NST (NH)	<b>N37-50F45F</b>
	5" NPT	<b>N37-50F50T</b>
	6" NST (NH)	<b>N37-50F60F</b>
5" NPSH	6" NST (NH)	<b>N37-50S60F</b>
5" NPT	5" NST (NH)	<b>N37-50T50F</b>
6" NST (NH)	4" NPT	<b>N37-60F40T</b>
	5" NST (NH)	<b>N37-60F50F</b>
	6" NPT	<b>N37-60F60T</b>
6" NPT	4" NST (NH)	<b>N37-60T40F</b>
	6" NST (NH)	<b>N37-60T60F</b>

Fire Fittings & Accessories



- All adapters are made to approved Dixon® specifications.
- Replacement washers can be found on page 785

Brass Female Swivel to Male Adapters  
Pin Lug

Female NST (NH) Thread	Male NPT Thread	Cast Brass Part #
1½"	1½"	<b>SM150F</b>
2½"	1½"	<b>SM25F15T</b>
	2"	<b>SM25F20T</b>
	2½"	<b>SM250F</b>
	3"	<b>SM25F30T</b>
4"	4"	<b>SM400F</b>

Female NPSH Thread	Male NPT Thread	Cast Brass Part #
1½"	1½"	<b>SM150S</b>
2"	2"	<b>SM200S</b>
2½"	2½"	<b>SM250S</b>

Female Thread	Male NST (NH) Thread	Cast Brass Part #
1½" NPSH	1½"	<b>SM15S15F</b>
2½" NST (NH)	3"	<b>SM25F30F</b>

Female Thread	Male NPT Thread	Cast Brass Part #
1½" NYFD	1½"	<b>SM150NYFD</b>
2½" NYFD	2½"	<b>SM250NYFD</b>



Rocker Lug

Female Thread	Male NPT Thread	Cast Brass Part #
1½" NST (NH)	1½"	<b>RSM150F</b>
1½" NPSH	1½"	<b>RSM150S</b>
2½" NST (NH)	2"	<b>RSM25F20T</b>
	2½"	<b>RSM250F</b>
	3"	<b>RSM25F30T</b>



Domestic Male Swivel Adapters - Pin Lug

Female NST (NH) Swivel Thread	Male NPT Thread	Cast Brass Part #
1½"	1½"	<b>SM150F-D</b>
2½"	2½"	<b>SM250F-D</b>
	2"	<b>SM25F20T-D</b>
	3"	<b>SM25F30T-D</b>



- All adapters are made to approved Dixon® specifications.
- Replacement washers can be found on page 785

Male Rocker Lug - Suction with Poly Screen



**Feature:**

- suction intake with strainer screen

Female NST (NH) Thread	Male NPT Thread	Cast Brass Part #
2½"	2" 2½" 3"	<b>RSMSA25F20T</b> <b>RSMSA250F</b> <b>RSMSA25F30T</b>

Male Rocker Lug - Suction with Zinc Screen



**Feature:**

- suction intake with zinc strainer screen - excellent to use before backflow preventers

Female NST (NH) Thread	Male NPT Thread	Cast Brass Part #
2½"	2" 2½" 3"	<b>RSMSA25F20T-Z</b> <b>RSMSA250F-Z</b> <b>RSMSA25F30T-Z</b>

Male Rocker Lug - Suction with Poly Screen



**Feature:**

- suction intake with strainer screen

Female NST (NH) Thread	Male NPT Thread	Aluminum Part #
2½"	2" 2½"	<b>ARMSA25F20T</b> <b>ARMSA250F</b>

- All adapters are made to approved Dixon® specifications.
- Replacement washers can be found on page 785

Female Swivel to Male Adapters - Rocker Lug Style N54

Female Swivel Thread	Male Rigid Thread	Aluminum Extrusion - Anodized Part #
1½" NST (NH)	1½" NST (NH)	<b>N54-15F15F</b>
	1½" NPT	<b>N54-15F15T</b>
	2½" NST (NH)	<b>N54-15F25F</b>
1½" NPSH	1½" NPSH	<b>N54-15S15S</b>
	1½" NPT	<b>N54-15S15T</b>
2½" NST (NH)	1½" NST (NH)	<b>N54-25F15F</b>
	1½" NPT	<b>N54-25F15T</b>
	2" NPT	<b>N54-25F20T</b>
	2½" NST (NH)	<b>N54-25F25F</b>
	2½" NPT	<b>N54-25F25T</b>
	3" NPT	<b>N54-25F30T</b>
2½" NPSH	2" NPT	<b>N54-25S20T</b>
3" NPSH	3" NPT	<b>N54-30S30T</b>
4" NST (NH)	4" NST (NH)	<b>N54-40F40F</b>
	4" NPT	<b>N54-40F40T</b>
	6" NST (NH)	<b>N54-40F60F</b>
4½" NST (NH)	4" NPT	<b>N54-45F40T</b>
	6" NPT	<b>N54-45F60T</b>
6" NST (NH)	6" NPT	<b>N54-60F60T</b>



Female Swivel to Male Adapters - Long Handle Style N54L

Female NST Thread	Male Thread	Aluminum Extrusion - Anodized Part #
2½"	2½" NST (NH)	<b>N54L-25F25F</b>
4"	6" NST (NH)	<b>N54L-40F60F</b>
4½"	4" NPT	<b>N54L-45F40T</b>
6"	4" NPT	<b>N54L-60F40T</b>
	5" NST (NH)	<b>N54L-60F50F</b>
	6" NPT	<b>N54L-60F60T</b>



- All adapters are made to approved Dixon® specifications.
- Replacement washers can be found on page 785

## Double Male Hex Nipples

**Feature:**

- other configurations are available, consult Dixon® for information



reducer



same size



increaser

Male Thread	Male Thread	Cast Brass Part #
¾" NPT	1½" NPSH	<b>DMH7515</b>
	1½" NST (NH)	<b>DMH7515F</b>
1" NPT	¾" GHT	<b>DMH1076</b>
	1" NPSH	<b>DMH1010</b>
	1" NST (NH)	<b>DMH1010F</b>
	1½" NPSH	<b>DMH1015</b>
	1½" NST (NH)	<b>DMH1015F</b>
	2½" NST (NH)	<b>DMH1025F</b>
1½" NPSH	1½" NPSH	<b>DMH15S15S</b>
1½" NPT	1" NPSH	<b>DMH1510</b>
	1" NST (NH)	<b>DMH1510F</b>
	1½" NPSH	<b>DMH1515</b>
	1½" NPT	<b>DMH1515T</b>
	1½" NST (NH)	<b>DMH1515F</b>
	2" NPSH	<b>DMH1520</b>
	2½" NST (NH)	<b>DMH1525F</b>
1½" NST (NH)	1½" NPSH	<b>DMH15F15S</b>
	1½" NST (NH)	<b>DMH15F15F</b>
	2½" NST (NH)	<b>DMH15F25F</b>
2" NPT	1½" NPSH	<b>DMH2015</b>
	1½" NST (NH)	<b>DMH2015F</b>
	2" NPSH	<b>DMH2020</b>
	2½" NPSH	<b>DMH2025</b>
	2" NPT	<b>DMH2020T</b>
	2½" NST (NH)	<b>DMH2025F</b>
2½" NPT	1½" NPSH	<b>DMH2515</b>
	1½" NST (NH)	<b>DMH2515F</b>
	2" NPSH	<b>DMH2520</b>
	2½" NPSH	<b>DMH2525</b>
	2½" NST (NH)	<b>DMH2525F</b>
	2½" NPT	<b>DMH2525T</b>
	3" NPSH	<b>DMH2530</b>
	3" NPT	<b>DMH2530T</b>
	3" NST (NH)	<b>DMH2530F</b>
2½" NST (NH)	2½" NST (NH)	<b>DMH25F25F</b>
	3" NST (NH)	<b>DMH25F30F</b>
3" NPT	2½" NPSH	<b>DMH3025</b>
	2½" NST (NH)	<b>DMH3025F</b>
	3" NPSH	<b>DMH3030</b>
	3" NST (NH)	<b>DMH3030F</b>
3" NPT	3" NPT	<b>DMH3030T</b>
4" NPT	4" NPSH	<b>DMH4040</b>
4" NST (NH)	4" NST	<b>DMH40F40F</b>
4" NPT	4" NST (NH)	<b>DMH4040F</b>
	4½" NST (NH)	<b>DMH4045F</b>
	4" NPT	<b>DMH4040T</b>
5" NPT	5" NST (NH)	<b>DMH5050F</b>
6" NPT	4½" NST (NH)	<b>DMH6045F</b>
	6" NST (NH)	<b>DMH6060F</b>
	6" NPSH	<b>DMH6060</b>
	6" NPT	<b>DMH6060T</b>

- All adapters are made to approved Dixon® specifications.



## Double Male Hex Adapters (NYFD Threads)

**Feature:**

- other configurations are available, consult Dixon® for information

Male Thread	Male NYFD Thread	Cast Brass Part #
1½" NPT	1½"	<b>DMH1515NYFD</b>
1½" NST (NH)	1½"	<b>DMH15F15NYFD</b>
1½" NPT	2½"	<b>DMH1525NYFD</b>
2" NPT	2½"	<b>DMH2025NYFD</b>
2½" NPT	1½"	<b>DMH2515NYFD</b>
2½" NPT	2½"	<b>DMH2525NYFD</b>

Male NST (NH) Thread	Male NYFD Thread	Cast Brass Part #
2½"	2½"	<b>DMH25F25NYFD</b>

Male NYFD Thread	Male NYFD Thread	Cast Brass Part #
1½"	1½"	<b>DMH15NYFD15NYFD</b>
2½"	2½"	<b>DMH25NYFD25NYFD</b>

- NYFD thread: 3.031 x 8 TPI



reducer



same size



increaser

- All adapters are made to approved Dixon® specifications.

Domestic Double Male Hex Adapters



reducer



same size



increaser

**Feature:**

- other configurations are available, consult Dixon® for information

Male Thread	Male Thread	Cast Brass Part #
1" NPT	1" NST (NH)	<b>DMH1010F-D</b>
	1½" NST (NH)	<b>DMH1015F-D</b>
1½" NPT	1½" NPSH	<b>DMH1515-D</b>
	1½" NST (NH)	<b>DMH1515F-D</b>
	2½" NST (NH)	<b>DMH1525F-D</b>
1½" NST (NH)	1½" NST (NH)	<b>DMH15F15F-D</b>
	1½" NPSH	<b>DMH15F15S-D</b>
	2½" NST (NH)	<b>DMH15F25F-D</b>
2" NPT	1½" NST (NH)	<b>DMH2015F-D</b>
	2" NPSH	<b>DMH2020-D</b>
	2½" NST (NH)	<b>DMH2025F-D</b>
2½" NPT	1½" NST (NH)	<b>DMH2515F-D</b>
	2½" NST (NH)	<b>DMH2525F-D</b>
2½" NST (NH)	2½" NST (NH)	<b>DMH25F25F-D</b>
		<b>DMH3025F-D</b>
3" NPT	2½" NST (NH)	<b>DMH3030F-D</b>
	3" NST (NH)	<b>DMH3030F-D</b>
4" NPT	4½" NST (NH)	<b>DMH4045F-D</b>
	6" NST (NH)	<b>DMH6060F-D</b>

Double Male Adapters

**Feature:**

- other configurations are available, consult Dixon® for information



**Pin Lug**

Male Thread	Male Thread	Cast Brass Part #
1½" NST (NH)	1½" NST (NH)	<b>DMP1515F</b>
	1½" NPT	<b>DMP15F15T</b>
1½" NPSH	1½" NPSH	<b>DMP1515</b>
	1½" NPT	<b>DMP15S15T</b>
1½" NST (NH)	1½" NPSH	<b>DMP15F15S</b>
2½" NST (NH)	2½" NST (NH)	<b>DMP2525F</b>
	2½" NPSH	<b>DMP25F25S</b>
	2½" NPT	<b>DMP25F25T</b>
2½" NPSH	2½" NPSH	<b>DMP2525</b>

**Rocker Lug**



Male Thread	Male Thread	Cast Brass Part #
1½" NST (NH)	1½" NST (NH)	<b>DMR1515F</b>
	1½" NPT	<b>DMR15F15T</b>
	1½" NPSH	<b>DMR15F15S</b>
1½" NPSH	1½" NPSH	<b>DMR1515</b>
	1½" NPT	<b>DMR15S15T</b>
2½" NST (NH)	2½" NST (NH)	<b>DMR2525F</b>
	2½" NPSH	<b>DMR2525</b>

- All adapters are made to approved Dixon® specifications.

Double Male Adapters - Rocker Lug  
Style N36

Male NST (NH) Thread	Male Thread	Aluminum Extrusion - Anodized Part #
1"	1" NST (NH)	<b>N36-10F10F</b>
1½"	1½" NST (NH)	<b>N36-15F15F</b>
	2" NPT	<b>N36-15F20T</b>
	2½" NST (NH)	<b>N36-15F25F</b>
2½"	2½" NST (NH)	<b>N36-25F25F</b>
	3" NST (NH)	<b>N36-25F30F</b>
	3" NPT	<b>N36-25F30T</b>
	4" NST (NH)	<b>N36-25F40F</b>
	4" NPT	<b>N36-25F40T</b>
	4½" NST (NH)	<b>N36-25F45F</b>
3"	3" NST (NH)	<b>N36-30F30F</b>
4"	4" NST (NH)	<b>N36-40F40F</b>
4½"	4½" NST (NH)	<b>N36-45F45F</b>
6"	6" NST (NH)	<b>N36-60F60F</b>
Male NPT Thread	Male Thread	Aluminum Extrusion - Anodized Part #
1½"	1½" NST (NH)	<b>N36-15T15F</b>
	2½" NST (NH)	<b>N36-15T25F</b>
2"	2" NPT	<b>N36-20T20T</b>
	2½" NST (NH)	<b>N36-20T25F</b>
2½"	2½" NST (NH)	<b>N36-25T25F</b>
	3" NPT	<b>N36-25T30T</b>
	4" NPT	<b>N36-25T40T</b>
3"	3" NST (NH)	<b>N36-30T30F</b>
4"	4" NST (NH)	<b>N36-40T40F</b>
	4½" NST (NH)	<b>N36-40T45F</b>
5"	6" NPT	<b>N36-50T60T</b>
6"	6" NST (NH)	<b>N36-60T60F</b>
Male NPSH Thread	Male Thread	Aluminum Extrusion - Anodized Part #
1"	1" NPSH	<b>N36-10S10S</b>
1½"	1½" NST (NH)	<b>N36-15S15F</b>
	1½" NPSH	<b>N36-15S15S</b>
	1½" NPT	<b>N36-15S15T</b>
	2" NPSH	<b>N36-15S20S</b>
2½"	2½" NST (NH)	<b>N36-25S25F</b>
	2½" NPSH	<b>N36-25S25S</b>



same size



increaser

Cam and Groove Hydrant Adapters

Features:

- pin lugs allow for easy connection using standard spanner and hydrant wrenches on pages 799 - 802
- supplied with a Buna-N washer in the threaded end

Female NST (NH) Thread	Male Adapter	Brass Part #	Aluminum Part #
1½"	1½"	<b>HA1515ADP</b>	<b>AHA1515ADP</b>
2½"	2½"	<b>HA2525ADP</b>	<b>AHA2525ADP</b>



Replacement Washers

ID	OD	Thickness	Buna-N Part #
1-9/16"	2-1/16"	1/8"	<b>SW150</b>
2-9/16"	3-3/16"	3/16"	<b>SW250</b>



- All adapters are made to approved Dixon® specifications.

Cam and Groove x NST

Features:

- powder coated aluminum adapter
- for suction and low pressure discharge only
- other sizes, configurations and materials available, contact Dixon® for information



Type A x Female NST (NH)

Adapter Size	Female NST (NH) Thread	Aluminum Part #
1½"	1½"	<b>G150-A-ALNST</b>
2½"	2½"	<b>G250-A-ALNST</b>
3"	2½"	<b>3025-A-ALNST</b>

Type B x Male NST (NH)

Feature:

- Buna seals standard



Coupler Size	Male NST (NH) Thread	Aluminum Part #
1½"	1½"	<b>G150-B-ALNST</b>
2"	1½"	<b>2015-B-ALNST</b>
2½"	2½"	<b>G250-B-ALNST</b>
3"	2½"	<b>3025-B-ALNST</b>

Type D x Female NST (NH)

Feature:

- Buna seals standard



Coupler Size	Female NST (NH) Thread	Aluminum Part #
1½"	1½"	<b>G150-D-ALNST</b>
2"	2½"	<b>2025-D-ALNST</b>
2½"	2½"	<b>G250-D-ALNST</b>
3"	2½"	<b>3025-D-ALNST</b>

Type F x Male NST (NH)



Adapter Size	Male NST (NH) Thread	Aluminum Part #
1½"	1½"	<b>G150-F-ALNST</b>
2"	2½"	<b>2025-F-ALNST</b>
2½"	2½"	<b>G250-F-ALNST</b>
3"	2½"	<b>3025-F-ALNST</b>

## Brass Caps Pin Lug

**Features:**

- finishes: -P polished, -C polished chrome plated
- NOT intended for pressure applications - for debris and thread protection only 

NST (NH) Thread	Cast Brass Part #
1½"	<b>FC150F</b> <b>FC150F-P</b> <b>FC150F-C</b>
2"	<b>FC200F</b> <b>FC250F</b> <b>FC250F-P</b> <b>FC250F-C</b>
2½"	<b>FC300F</b> <b>FC400F</b> <b>FC450F</b> <b>FC600F</b>
3"	
4"	
4½"	
6"	
NPSH Thread	Cast Brass Part #
1½"	<b>FC150</b>
2"	<b>FC200</b>
2½"	<b>FC250</b>
3"	<b>FC300</b>
4"	<b>FC400</b>
6"	<b>FC600</b>



## Rocker Lug

**Feature:**

- finishes: -P polished, -C polished chrome plated

NST (NH) Thread	Cast Brass Part #
1"	<b>RFC100F</b>
1½"	<b>RFC150F</b>
2½"	<b>RFC250F</b> <b>RFC250F-C</b>
NPSH Thread	Cast Brass Part #
¾"	<b>RFC075</b>
1"	<b>RFC100</b>
1½"	<b>RFC150</b>
2"	<b>RFC200</b>
2½"	<b>RFC250</b>



## Brass Test Caps

**Features:**

- pet cock port supplied with ⅛" NPT
- drain cock port supplied with ¼" NPT

NST (NH) Thread	Brass Part #
2½"	<b>NST250TC</b>



Aluminum Caps with Cable

Rocker Lug

Features:

- other configurations are available, consult Dixon® for information, not all configurations are stocked
- aircraft cable (coated) included

Size	Thread	Extruded Hardcoated Aluminum Part #
1"	NST (NH)	<b>CAP100F-C</b>
1½"		<b>CAP150F-C</b>
2"		<b>CAP200F-C</b>
2½"		<b>CAP250F-C</b>
3"		<b>CAP300F-C</b>
4"		<b>CAP400F-C</b>
4½"		<b>CAP450F-C</b>
5"		<b>CAP500F-C</b>
6"	<b>CAP600F-C</b>	
1"	NPSH	<b>CAP100S-C</b>
1½"		<b>CAP150S-C</b>
2"		<b>CAP200S-C</b>
2½"		<b>CAP250S-C</b>

Fire Fittings & Accessories



Long Handle

NST (NH) Thread	Extruded Hardcoated Aluminum Part #
4"	<b>CAP400F-C-LH</b>
4½"	<b>CAP450F-C-LH</b>
5"	<b>CAP500F-C-LH</b>
6"	<b>CAP600F-C-LH</b>



Aluminum Test Caps

Feature:

- supplied with ¼" NPT drill and tap

Size	Thread	Aluminum Part #
1½"	NST (NH)	<b>CAP150FABS</b>
2"		<b>CAP200FABS</b>
2½"		<b>CAP250FABS</b>
3"		<b>CAP300FABS</b>
4"		<b>CAP400FABS</b>
4½"		<b>CAP450FABS</b>
5"		<b>CAP500FABS</b>
6"		<b>CAP600FABS</b>
1½"	NPSH	<b>CAP150SABS</b>
2"		<b>CAP200SABS</b>
2½"		<b>CAP250SABS</b>
3"		<b>CAP300SABS</b>
4"		<b>CAP400SABS</b>
4½"		<b>CAP450SABS</b>
5"		<b>CAP500SABS</b>
6"		<b>CAP600SABS</b>



## Thermoplastic Caps

### Caps with Chain

**Application:**

- prevents entry of foreign material and protects male outlet threads on valves and hydrants

**Feature:**

- NOT intended to be pressurized 

Size	Thread	Polycarbonate Part #
1½"	NPSH NST (NH)	<b>PFCW150</b> <b>PFCW150F</b>
2"	NPSH	<b>PFCW200</b>
2½"	NST (NH)	<b>PFCW250F</b>
3"	NST	<b>PFCW300F</b>



### Pressurizable Cap with Chains

**Feature:**

- can be pressurized to **300 PSI**

Size	Thread	Polycarbonate Part #
2½"	NST (NH) Thread	<b>PFC250F</b>



### Hydrant Caps

**Features:**

- 1⅛" pentagonal nut with weep hole
- gasket not included

NST (NH) Thread	Polycarbonate Part #
2½"	<b>PFCW250F-Y</b>
4"	<b>PFCW400F-Y</b>
4½"	<b>PFCW450F-Y</b>



### Universal Hose Cap

**Features:**

- universal push on - pull off cap protects all threads by gripping the valve or outlet on the inside of the waterway
- NOT intended to be pressurized 

Size	Polycarbonate Part #
2½"	<b>PFC250U</b>



## Breakable Caps

### Polycarbonate

**Application:**

- prevents entry of foreign material and protects female threads on pin lug fire department inlet connections

**Feature:**

- used on pin lug females



Size	Polycarbonate Part #
2½"	<b>PBC250</b>

### Aluminum

**Features:**

- for use on fire department inlet connections
- prevents entry of foreign matter and protects female threads
- breakable ears feature permits fast hose connection
- two eyebolts with nuts for attachment to female pin lug swivel
- painted red finish

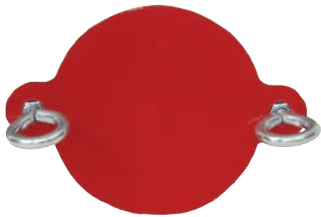

Size	Aluminum Part #
2½"	<b>ABC250</b>

## Specialty Caps

### Domestic Caps - Pin Lug

**Feature:**

- other sizes, threads, and finishes available, call Dixon® for information



Size	Thread	Brass Part #
1½"	NST (NH)	<b>FC150F-D</b>
2½"		<b>FC250F-D</b>

Note: jack chains with S-hooks can be found on page 172

### Hydrant Caps

**Features:**

- pentagon fire hydrant cap
- supplied with chain and ring



Size	Thread	Iron Part #
2½"	NST (NH)	<b>IHC250F</b>
4½"	NST (NH)	<b>IHC450F</b>

Note: jack chains with S-hooks can be found on page 172



Specialty Caps

Plugs with Cable - Rocker Lug

Feature:

- NC: no cable option available

Size	Extruded Hardcoated Aluminum	
	NST (NH) Part #	NPSH Part #
1½"	<b>PLUG150F-C</b>	<b>PLUG150S-C</b>
2½"	<b>PLUG250F-C</b>	<b>PLUG250S-C</b>
3"	<b>PLUG300F-C</b>	<b>PLUG300S-C</b>
4"	<b>PLUG400F-C</b>	---
4½"	<b>PLUG450F-C</b>	---
5"	<b>PLUG500F-C</b>	---
6"	<b>PLUG600F-C</b>	---



Fire Fittings & Accessories

Cap Test Gauges

Application:

Used for testing hose or static pressure on hydrants or trucks

Features:

- rocker lug swivel
- petcock to release pressure
- supplied with a 0-300 PSI glycerine 3½" diameter gauge

NST (NH) Thread	Hardcoated Aluminum Part #
1½"	<b>AFC150F-TGWP</b>
2½"	<b>AFC250F-TGWP</b>



FDC Plugs

Features:

- fits standard 2½" NST (NH) female swivel
- withstands wide range of temperatures from -4°F to 200°F (-20°C to 93°C)
- 1⅛" pentagonal nut with weep hole to allow for drainage
- removed from FDC with adjustable hydrant wrench

Size	Thread	Polycarbonate Part #
1½"	NST (NH)	<b>PP150F</b> <b>NEW</b>
2½"	NST (NH)	<b>PP250F</b>
2½"	NYFD	<b>PP250NYFD</b> <b>NEW</b>



Adjust-A-Plug

Features:

- molded red polycarbonate protective plug for swivel connections up to 2½"
- two adjustable metal plates installed in the back of the plug can be mated with your local thread
- plug can be easily removed with a fire department spanner wrench

Polycarbonate Part #
<b>PAP250</b>



front



back

## Brass Plugs

### Pin Lug

**Features:**

- finishes: -P polished, -C polished chrome plated
- NOT intended for pressure applications - for debris and thread protection only 



NST (NH) Thread	Cast Brass Part #
1½"	<b>FP150F</b> <b>FP150F-P</b> <b>FP150F-C</b>
2½"	<b>FP250F</b> <b>FP250F-P</b> <b>FP250F-C</b>
3"	<b>FP300F</b>
4"	<b>FP400F</b>
4½"	<b>FP450F</b>
NPSH Thread	Cast Brass Part #
1½"	<b>FP150</b>
2½"	<b>FP250</b>

### Rocker Lug

**Feature:**

- finishes: -P polished, -C polished chrome plated



NST (NH) Thread	Cast Brass Part #
1½"	<b>RFP150F</b>
2½"	<b>RFP250F</b>

### Domestic Plugs - Pin Lug



NST (NH) Thread	Brass Part #
1½"	<b>FP150F-D</b>
2½"	<b>FP250F-D</b>

## Brass Replacement Swivels and Accessories

**Features:**

- replacement brass swivels for Dixon® fire department connections
- swivel comes with gasket, set screw and ball bearings needed to install on FDC
- other configurations are available, contact Dixon® for information



Size	Female Thread	Brass Part #
2½"	NPSH (2.84x8)	<b>PSNP250S</b>
	NST (NH) (3.07x7.5)	<b>PSNP250NST</b>
	NYC/BA (3.00x8)	<b>PSNP250NYC</b>
	NYFD (3.03x8)	<b>PSNP250NYFD</b>
3"	NST (NH)	<b>PSNP300NST</b>
	NYFD	<b>PSNP300NYFD</b>

- 2½" requires 50 ball bearings, 3" requires 58 ball bearings

### Replacement Parts



4600300001

Description	Part #
2½" gasket	<b>SW250</b>
3" gasket	<b>SW300F</b>
ball bearings	<b>4600300001</b>
set screw	<b>4601100418</b>

FSA-Storz x Rigid Female

Features:

- for use wherever a non-valved, locking coupling is required
- anodized components per MIL-A-8625 Type III Class 1
- Buna-N gaskets
- working pressure: **150 PSI at 70°F (21°C)**
- cast aluminum lock lever assembly on 4", 5" and 6"

Storz x NST (NH) Female

Storz Size	NST (NH) Female Thread	6061-T6 Forged Aluminum Part #
1½"	1½"	<b>FSA1515F</b>
2"	1½"	<b>FSA2015F</b>
	2½"	<b>FSA2025F</b>
2½"	2½"	<b>FSA2525F</b>
	3"	<b>FSA3025F</b>
4"	2½"	<b>FSA4025F</b>
	3"	<b>FSA4030F</b>
	4"	<b>FSA4040F</b>
	4½"	<b>FSA4045F</b>
	5"	<b>FSA4050F</b>
	6"	<b>FSA4060F</b>
5"	2½"	<b>FSA5025F</b>
	3"	<b>FSA5030F</b>
	4"	<b>FSA5040F</b>
	4½"	<b>FSA5045F</b>
	5"	<b>FSA5050F</b>
6"	6"	<b>FSA5060F</b>
	6"	<b>FSA6060F</b>



Storz x NPT Female

Storz Size	NPT Female Thread	6061-T6 Forged Aluminum Part #
1½"	1"	<b>FSA1510T</b>
	1½"	<b>FSA1515T</b>
2"	1½"	<b>FSA2015T</b>
	2"	<b>FSA2020T</b>
2½"	1½"	<b>FSA2515T</b>
	2"	<b>FSA2520T</b>
	2½"	<b>FSA2525T</b>
	3"	<b>FSA2530T</b>
3"	3"	<b>FSA3030T</b>
	3"	<b>FSA4030T</b>
	4"	<b>FSA4040T</b>
4"	6"	<b>FSA4060T</b>
	3"	<b>FSA5030T</b>
	4"	<b>FSA5040T</b>
5"	5"	<b>FSA5050T</b>
	6"	<b>FSA5060T</b>
	4"	<b>FSA6040T</b>
6"	6"	<b>FSA6060T</b>



Storz x NPSH Female

Storz Size	NPSH Female Thread	6061-T6 Forged Aluminum Part #
1½"	1½"	<b>FSA1515S</b>
2"	1½"	<b>FSA2015S</b>
2½"	2½"	<b>FSA2525S</b>
4"	4"	<b>FSA4040S</b>



- All adapters are made to approved Dixon® specifications.
- Replacement washers can be found on page 798

SFSA - Storz x Swivel Female Adapter - Rocker Lug / Long Handle

Fire Fittings & Accessories

**Features:**

- anodized components per MIL-A-8625 Type III Class 1
- Buna-N gaskets
- working pressure: **150 PSI at 70°F (21°C)**
- cast aluminum lock lever assembly on 4", 5" and 6"

**Storz x NST (NH) Female Swivel**

Storz Size	NST (NH) Female Swivel Thread	6061-T6 Forged Alumium Part #
2½"	2½"	<b>SFSA2525F</b>
3"	2½"	<b>SFSA3025F</b>
4"	2½"	<b>SFSA4025F</b>
	3"	<b>SFSA4030F</b>
	4"	<b>SFSA4040F</b>
	4½"	<b>SFSA4045F</b>
5"	6"	<b>SFSA4060F</b>
	2½"	<b>SFSA5025F</b>
	4"	<b>SFSA5040F</b>
6"	4½"	<b>SFSA5045F</b>
	6"	<b>SFSA5060F</b>
	6"	<b>SFSA6060F</b>



**Storz x NPSH Female**

Storz Size	NPSH Female Swivel Thread	6061-T6 Forged Alumium Part #
2½"	2½"	<b>SFSA2525S</b>
3"	3"	<b>SFSA3030S</b>
4"	4"	<b>SFSA4040S</b>
5"	6"	<b>SFSA5060S</b>



**Storz x NST (NH) Female Swivel - Long Handle**

Storz Size	NST (NH) Female Swivel Thread	6061-T6 Forged Alumium Part #
4"	4½"	<b>SFSA4045F-LH</b>
5"	4"	<b>SFSA5040F-LH</b>
5"	4½"	<b>SFSA5045F-LH</b>
6"	6"	<b>SFSA6060F-LH</b>



- All adapters are made to approved Dixon® specifications.
- Replacement washers can be found on page 798



MSA - Storz x Rigid Male

Storz x NST (NH) Male

Storz Size	NST (NH) Male Thread	6061-T6 Forged Alumium Part #
1½"	1½"	<b>MSA1515F</b>
2"	1½"	<b>MSA2015F</b>
2½"	2½"	<b>MSA2525F</b>
3"	2½"	<b>MSA3025F</b>
4"	2½"	<b>MSA4025F</b>
	4"	<b>MSA4040F</b>
	4½"	<b>MSA4045F</b>
5"	2½"	<b>MSA5025F</b>
	5"	<b>MSA5050F</b>



Fire Fittings & Accessories

Storz x NPT Male

Storz Size	NPT Male Thread	6061-T6 Forged Alumium Part #
1½"	1½"	<b>MSA1515T</b>
2"	1½"	<b>MSA2015T</b>
2½"	2"	<b>MSA2520T</b>
	2½"	<b>MSA2525T</b>
	3"	<b>MSA2530T</b>
3"	3"	<b>MSA3030T</b>
4"	4½"	<b>MSA4025T</b>
	4"	<b>MSA4040T</b>
5"	4"	<b>MSA5040T</b>
6"	6"	<b>MSA6060T</b>



Storz x NPSH Male

Storz Size	NPSH Male Thread	6061-T6 Forged Alumium Part #
1½"	1½"	<b>MSA1515S</b>
2"	1½"	<b>MSA2015S</b>



1½" x 1½"

- All adapters are made to approved Dixon® specifications.



### SFSA30 - Storz x Female Swivel 30° Elbow - Rocker Lug



**Features:**

- anodized components per MIL-A-8625 Type III Class 1
- Buna-N gaskets
- working pressure: **150 PSI at 70°F (21°C)**
- cast aluminum lock lever assembly on 4", 5" and 6"
- screens available for 4" and 5" heads, consult Dixon® for information

Storz Size	NST (NH) Female Swivel Thread	6061-T6 Forged Alumium Part #
4"	4"	<b>SFSA30-4040F</b>
	5"	<b>SFSA30-4050F</b>
	6"	<b>SFSA30-4060F</b>
5"	3"	<b>SFSA30-5030F</b>
	4"	<b>SFSA30-5040F</b>
	4½"	<b>SFSA30-5045F</b>
	6"	<b>SFSA30-5060F</b>

- Replacement washers can be found on page 798

### SFSA30 - Storz x Female Swivel 30° Elbow - Long Handle



**Features:**

- anodized components per MIL-A-8625 Type III Class 1
- Buna-N gaskets
- working pressure: **150 PSI at 70°F (21°C)**
- cast aluminum lock lever assembly on 4", 5" and 6"

Storz Size	NST (NH) Female Swivel Thread	6061-T6 Forged Alumium Part #
4"	4½"	<b>SFSA30-4045F-LH</b>
	5"	<b>SFSA30-4050F-LH</b>
	6"	<b>SFSA30-4060F-LH</b>

- Replacement washers can be found on page 798

### NCS-CSF - 150 lbs. Carbon Steel Flange x Storz



150# Flange	Storz	Carbon Steel Part #
4"	5"	<b>NCS-CSF-STZ450</b>
	6"	<b>NCS-CSF-STZ460</b>
5"	4"	<b>NCS-CSF-STZ540</b>
	5"	<b>NCS-CSF-STZ550</b>
	6"	<b>NCS-CSF-STZ560</b>
6"	4"	<b>NCS-CSF-STZ640</b>
	5"	<b>NCS-CSF-STZ650</b>
	6"	<b>NCS-CSF-STZ660</b>

- For flange dimensions, diagrams and additional information please reference [dixonvalve.com](http://dixonvalve.com).

### NCS-CSF - 150 lbs. Carbon Steel Flange x Storz with Cap



150# Flange	Storz	Carbon Steel Part #
5"	6"	<b>NCS-CSF-STZ650C</b>
6"	6"	<b>NCS-CSF-STZ660C</b>

- For flange dimensions, diagrams and additional information please reference [dixonvalve.com](http://dixonvalve.com).

SSA - Storz x Storz Adapter

Features:

- anodized components per MIL-A-8625 Type III Class 1
- Buna-N gaskets
- working pressure: **150 PSI at 70°F (21°C)**
- cast aluminum lock lever assembly on 4", 5" and 6"

Storz Size	Storz Size	6061-T6 Forged Alumium Part #
1½"	2"	<b>SSA1520</b>
	2½"	<b>SSA1525</b>
2"	2½"	<b>SSA2025</b>
	3"	<b>SSA2030</b>
	4"	<b>SSA2540</b>
4"	5"	<b>SSA4050</b>
	6"	<b>SSA4060</b>
5"	6"	<b>SSA5060</b>



SSA30 - Storz x Storz 30° Elbow Adapters

Features:

- anodized components per MIL-A-8625 Type III Class 1
- Buna-N gaskets
- working pressure: **150 PSI at 70°F (21°C)**
- cast aluminum lock lever assembly on 4", 5" and 6"

Storz Size	Storz Size	6061-T6 Forged Alumium Part #
5"	5"	<b>SSA30-550</b>



Dixon Storz Hydrant Conversion Adapters

Features:

- designed to adapt 4½" NH threads found on most hydrants to Storz connection
- secured to hydrant by 3 set screws positioned around the rim
- hydrant side: metal face to seal to gasketed face on hose
- reflective stripe around the rim for ease of night time location

Size	Part #
5" Storz x 4 1/2" NH (NST)	<b>SHA5045F</b>



Storz Accessories

Fire Fittings & Accessories



Threaded Storz Mounting Plates (Bracket)

Storz Size	Anodized Aluminum Part #
1½" - 2½"	<b>SMB1525</b>
4" - 5"	<b>SMB450</b>

Storz Caps

Features:

- 4", 5", 6" supplied with cables
- 1½", 2", 2½", 3" supplied with chains



Storz Size	Aluminum Part #
1½"	<b>SC150-NL</b>
2"	<b>SC200-NL</b>
2½"	<b>SC250-NL</b>
3"	<b>SC300-NL</b>
4"	<b>SC400-NL</b>
4" ABS	<b>SC400ABS<sup>1</sup></b>
5"	<b>SC500-NL</b>
5" ABS	<b>SC500ABS<sup>1</sup></b>
6"	<b>SC600-NL</b>

<sup>1</sup> ABS includes airbleeder/petcock

Storz Gaskets

Features:

- gasket faces should be kept free of sand, grit, etc. and lubricated with O-ring grease or silicone
- pressure seals have a flat face
- suction seals have a beaded face



Storz Size	Buna-N Pressure Part #	Buna-N Suction Part #
1½"	<b>SGS150-NL<sup>1</sup></b>	<b>SGS150-NL</b>
2"	<b>SGP200</b>	<b>SGS200-NL</b>
2½"	<b>SGP250</b>	<b>SGS250-NL</b>
3"	<b>SGP300</b>	<b>SGS300-NL</b>
4"	<b>SGP400</b>	<b>SGS400-NL</b>
5"	<b>SGP500</b>	<b>SGS500-NL</b>
6"	<b>SGS600-NL<sup>1</sup></b>	<b>SGS600-NL</b>

<sup>1</sup> gasket can be used for both pressure and suction service

Storz Locking Device



Description	Part #
metal locking device used on 4" and 5" Storz heads with spring, screw and washer	<b>LOCKINGDEVICE</b>
metal locking device used on 6" Storz heads with spring, screw and washer	<b>LOCKINGDEVICE6</b>



Wrenches  
Universal Spanner

Features:

- for 3/4" to 3" pin lug and rocker lug couplings
- includes gas cock shutoff, pry bar and belt hook eye
- overall length 11 7/8"

Aluminum	Pkg
Part #	Qty
<b>USW</b>	25



Fire Fittings & Accessories

Universal

Features:

- for pin lug or rocker lug couplings 1" - 4 1/2"
- a gas cock shutoff is provided in the handle
- red epoxy painted
- overall length 11 3/4"

Iron	Pkg
Part #	Qty
<b>233</b>	



Hole Type Spanner

Features:

- designed for use on 3/4" and 1" booster hose couplings
- overall length is 7 1/2"

AL-MAG 35	Pkg
Part #	Qty
<b>HTSW</b>	



Storz Hydrant

Features:

- fits 4" and 5" Storz
- ductile iron head
- knurled chrome plated handle
- manganese bronze adjustable jaw
- includes adjustable hydrant nut wrench

Part #	Pkg
<b>SAHW</b>	Qty



Folding Pocket Spanner

Features:

- for pentagon nuts up to 1 3/4"
- built-in spanner for pin or rocker lug couplings
- overall length 16 1/4"

Material	Part #
aluminum	<b>PSW</b>
brass	<b>PSW-B</b>
die cast zinc	<b>PSW-Z</b>
yellow plastic	<b>PSW-Y</b>



Adjustable Hydrant

Features:

- fits 3/4" to 3" rocker lug and pin lug couplings
- a compact wrench easily carried in your jacket pocket

Aluminum	Pkg
Part #	Qty
<b>AHW</b>	20



Wrenches

Pigtail Adjustable Hydrant

Feature:

- double spanner head fits pin lug or rocker (sensible) lug couplings, pentagon nuts up to 1½" from point to flat, 1½" - 6" rocker lug caps, 2" - 4½" pin lug caps, and square nuts up to 1½"



Part #

**AHWPT**

Fire Fittings & Accessories

Heavy Duty Adjustable Hydrant

Features:

- for pentagon hydrant nuts up to 1¾" from point to flat
- notched to fit 1¼" square hydrant nut
- spanner for pin lug and sensible (rocker) lug couplings, 1½" thru 6"
- plated iron head, ⅞" plated steel handle
- overall length 18"



Part #

**189**

Pkg Qty

15

Double Head Adjustable Hydrant

Features:

- for pentagon hydrant nuts up to 1½" and square heads up to 1½"
- fits ¾" - 6" rocker lug or pin lug couplings, can also be used for long handle couplings
- ductile iron head with a deeply knurled chrome plated steel handle
- replaceable adjustable jaw is made of manganese bronze
- overall length 19½"



Part #

**189DH**

5 Hole Hydrant

Features:

- 5 pentagon holes designed to fit common hydrant nut sizes
- built-in spanner for pin or rocker lug couplings
- overall length: 14¼"



Plated Iron

Part #

**PHW**

Pkg

Qty

25

Grip-All Spanner

Features:

- fits ¾" - 6" split lug, rocker lug and pin lug couplings
- can be operated in tight quarters
- gas cock shutoff is provided in the handle, handle is shaped to fit your hand allowing a positive grip on the coupling



Aluminum

Part #

**GAW**

## Wrenches

### Hydrant

**Application:**

- used for hydrant work by water works companies and on construction sites

**Features:**

- overall length 15"
- fits up to 4" pin lug or rocker lug couplings
- complete with pry bar
- 1¼" square hydrant wrench



A356 Aluminum

Part #

**DF16-180**

**Features:**

- fits up to 2½" pin lug or rocker lug couplings
- complete with pry bar and 1¼" nut wrench
- lug / drum wrench



A356 Aluminum

Part #

**DF16-181**

### Long Handle Suction Spanner

**Features:**

- use on long handle, rocker lug, or pin lug couplings from 2½" - 6"
- open end slips over long handles for additional leverage, the claw fits rocker lugs or pin lugs, the other end can be used as a pry or crowbar
- inverted "T" body construction for lighter weight and improved strength
- can be used on Dixon® cam and groove pin lug or trapezoidal lug tank car adapters or 8" pin lug couplings
- overall length 18¾"



Plated Iron

Part #

**LHW**

### Forestry Hose Clamp and Spanner

**Features:**

- material: cast aluminum and brass
- off-set handle enables the user to easily operate the clamp while wearing gloves
- to be used with lightweight 1" and 1½" hoses for pressures up to 200 PSI
- when clamped onto the hose the brass locking device safely holds the clamp in position, a spanner is an integral part of the clamp
- overall length 10"



Cast Aluminum

Part #

**FHCS150**

### Forestry Pocket Spanners

**Features:**

- FSW1: for use on 1" hoses only
- FSW2: for 1" and 1½" hose couplings
- overall length 5"
- meets USFDA specification 5100-101C



Aluminum

Part #

**FSW1**

**FSW2**

Storz Wrenches

Pin Lug Spanner - Single End



Size	Plated Iron Part #
2"	<b>SW20</b>
2½"	<b>SW25</b>
3"	<b>SW30</b>
4"	<b>SW40</b>
6"	<b>SW60</b>

Pin Lug Spanner - Double End



Size	Plated Iron Part #
1½", 2" x 2½", 3"	<b>SW153</b>

Spanner - Single End



SZW2

- Features:**
- SW1530 fits 1½" - 3" Storz
  - SZW2 for use on 4" and 6" Storz



SW1530

Size	AL-MAG 35 Part #
1½" - 3"	<b>SW1530</b>
4" - 6"	<b>SZW2</b>

Spanner -Double End



SZW2-NL



SW-S400

Used On	Material	Part #
2" - 5"	<i>aluminum</i>	<b>SZW2-NL</b>
2" - 5"	<i>steel</i>	<b>SW-S400</b>

Holder with (2) Wrenches - Double Ended



Description	Material	Part #
2 Storz wrenches (2½" - 5") with bracket	<i>aluminum</i>	<b>SWB-2</b>
2 Storz wrenches (2½" - 5") with bracket	<i>steel</i>	<b>SWB-S-2</b>
4 Storz wrenches (2½" - 5") with bracket	<i>steel</i>	<b>SWB-S-4</b>

## Long Handle Short Shank Suction Hose Females

**Features:**

- powder coated aluminum swivel nut
- for suction and low pressure discharge only



Female Swivel NST (NH)	Hose Size	Powder Coated Aluminum Part #
4"	4"	<b>LHFS400F</b>
4½"	4"	<b>LHFS4045F</b>

## Angle and Suction Elbows

**Features:**

- for use on pump discharge valves, or suction inlets to minimize hose kinking
- rocker lug swivel
- satin brass finish
- -C polished chrome plated



30° elbow



45° elbow

Male NST (NH) Thread	Female NST (NH) Thread	Angle	Brass Part #
2½"	2½"	30°	<b>RSE30250F-C</b>
		45°	<b>RSE45250F</b>
		45°	<b>RSE45250F-C</b>
		90°	<b>RSE90250F</b>
		90°	<b>RSE90250F-C</b>

## Continuous Swivel Elbows

**Features:**

- allows hose to swing when connected
- full waterway reduces friction loss
- short style radius is 2½" measured from the center of the waterway to the end of the discharge thread



Female NPT Thread	Male Thread	Length	Cast Brass Part #
1½"	1½" NST (NH)	2½"	<b>CSES150F</b>
2"	1½" NST (NH)	2½"	<b>CSES2015F</b>
1½"	1½" NPT	2½"	<b>CSES150T</b>

## Dixon® Angle and Suction Elbows N54

**Features:**

- ideal for fire apparatus with front suction connections
- anodized, powder coated aluminum, extruded
- anodized female swivel connections



90° elbow

Male NST (NH) Thread	Female NST (NH) Swivel Thread	Angle	Aluminum Part #
2½"	2½"	30°	<b>N5430-25F25F</b>
		45°	<b>N5445-25F25F</b>
		60°	<b>N5460-25F25F</b>
		90°	<b>N5490-25F25F</b>

- Replacement washers can be found on page 785

Pump Test Headers

Fire Fittings & Accessories



flanged



Features:

- available connections: grooved, flanged and threaded
- certified D1, G1, G6
- other sizes, configurations available, consult Dixon® for information

End Connection	End Size	# of Outlets	Pump Size Max. GPM	Part #
150# flanged	3"	1	300	<i>HVF0301-25</i>
	4"	2	500	<i>HVF0402-25</i>
	6"	3	750	<i>HVF0603-25</i>
	6"	4	1000	<i>HVF0604-25</i>
	6"	6	1000	<i>HVF0606-25</i>
	8"	6	2000	<i>HVF0806-25</i>
grooved	6"	3	750	<i>HVG0603-25</i>
	6"	4	1000	<i>HVG0604-25</i>
	8"	3	750	<i>HVG0803-25</i>
	8"	6	2000	<i>HVG0806-25</i>

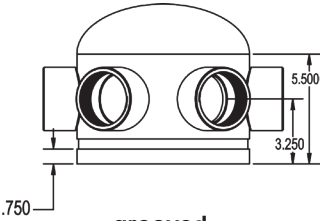

grooved

Manifolds



Model Number Breakdown

T98060-30

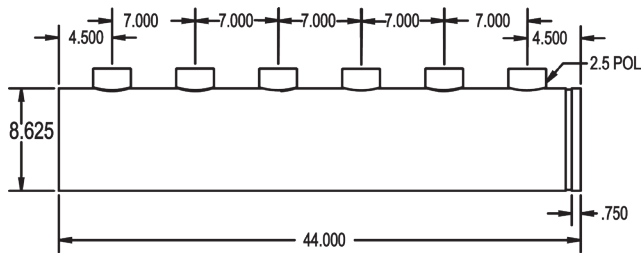
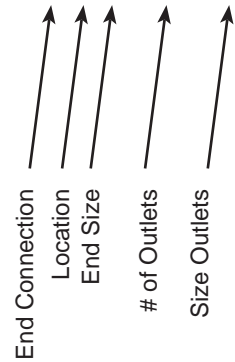

End Connection		Location		End Size		# of Outlets		Outlet Size	
T	threaded	E	End	40	4"	20	2	25	2½" FNPT
G	grooved	B	Back	60	6"	30	3	30	3" FNPT
F	flanged	9	90°	80	8"	40	4	---	---
---	---	---	---	---	---	60	6	---	---



Two Way Male Outlet - Roof Connections

**Features:**

- Used to create roof connections, fire pump test connections, wall hydrants or sidewalk (free standing) hydrants
- provides 250 GPM minimum per outlet
- UL listed
- maximum operating pressure: **175 PSI at 70°F (21°C)**
- other configurations are available, contact Dixon® for additional information

**back outlet**

Pipe Size	(2) Outlets Male	Cast Brass Part #
4"	2½" NPT	<b>IRC4025</b>
	2½" NPT	<b>FRC4025</b>
	2½" NST (NH)	<b>IRC4025F</b>
	2½" NST (NH)	<b>FRC4025F</b>
6"	2½" NPT	<b>FRC6025</b>
	2½" NST (NH)	<b>FRC6025F</b>



Groove Size	(2) Outlets Male	Cast Brass Part #
4"	2½" NST (NH)	<b>IRC4025GF</b>



**Dimensions**

Size	A	B	C
4" x 2½" x 2½"	7-7/8"	5-3/16"	5-1/4"
6" x 2½" x 2½"	8-3/16"	6-3/8"	7-5/8"

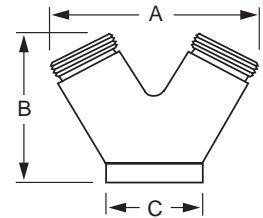

Two Way Male Outlet - Roof Connections



Fire Fittings & Accessories

**Features:**

- Used to create roof connections, fire pump test connections, wall hydrants or sidewalk (free standing) hydrants
- provides 250 GPM minimum per outlet
- UL listed
- maximum operating pressure: **175 PSI at 70°F (21°C)**

**90° bottom outlet**



Pipe Size	(2) Outlets Male	Cast Brass Part #
4"	2½" NPT	<b>90IRC4025</b>
	2½" NPT	<b>90FRC4025</b>
	2½" NST (NH)	<b>90IRC4025F</b>
	2½" NST (NH)	<b>90FRC4025F</b>
6"	2½" NPT	<b>90FRC6025</b>
	2½" NST (NH)	<b>90FRC6025F</b>



Groove Size	(2) Outlets Male	Cast Brass Part #
4"	2½" NPT	<b>90IRC4025G</b>
	2½" NST(NH)	<b>90IRC4025GF</b>

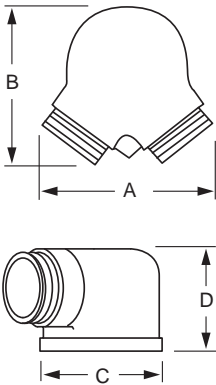

**Dimensions**

Size	A	B	C	D
4" x 2½" x 2½"	7½"	6¾"	5⅛"	4½"
6" x 2½" x 2½"	9"	8½"	7½"	5"



Three Way Male Outlet - Roof Connections

Features:

- used to create roof connections, or fire pump test connections
- provides 250 GPM minimum per outlet

back outlet

Pipe Size	(3) Outlets Male	Cast Brass Part #
4"	2½" NPT	<b>FR3C4025</b>
6"	2½" NPT 2½" NST (NH)	<b>FR3C6025</b> <b>FR3C6025F</b>



Dimensions

Size	A	B	C
4" x 2½" x 2½" x 2½"	12¾"	8¾"	5¼"
6" x 2½" x 2½" x 2½"	15⅝"	9¾"	7⅞"

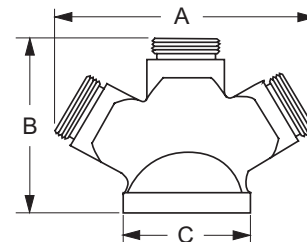

bottom outlet

Pipe Size	(3) Outlets Male	Cast Brass Part #
4"	2½" NPT 2½" NST (NH)	<b>90FR3C4025</b> <b>90FR3C4025F</b>
6"	2½" NPT 2½" NST (NH)	<b>90FR3C6025</b> <b>90FR3C6025F</b>



Dimensions

Size	A	B	C	D
4" x 2½" x 2½" x 2½"	7¾"	11¾"	4-7/16"	6¼"
6" x 2½" x 2½" x 2½"	7¾"	11¾"	4-7/16"	6¼"

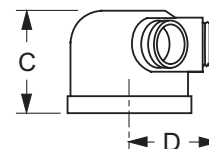
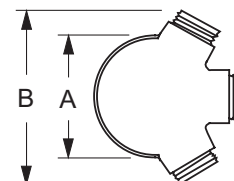

Sleeve for Sidewalk (free standing) Connections

Features:

- used in conjunction with a sidewalk escutcheon and a 90° double clapper Siamese to create a sidewalk (free standing) fire department connection
- finishes: -P polished, -C polished chrome plated

Pipe Size	Length	Brass Part #
4"	18"	<b>SS418-P</b>
	18"	<b>SS418-C</b>
	24"	<b>SS424-P</b>
	24"	<b>SS424-C</b>
6"	18"	<b>SS618-P</b>
	18"	<b>SS618-C</b>
	24"	<b>SS624-P</b>
	24"	<b>SS624-C</b>



## Single Clapper Siamese Connections

**Features:**

- single swing clapper with (2) pin lug swivel inlets
- provides 500 GPM minimum to supplement the fire protection as an auxiliary inlet connection to the water supply (250 GPM minimum per inlet)
- design provides unobstructed waterway
- exposed Fire Department Connections (FDC) provide an economical method of satisfying local fire codes
- branding: Auto-Spkr
- finishes: -P polished or -C polished chrome plated
- maximum operating pressure: **250 PSI at 70°F (21°C)**
- replacement swivels can be ordered on page 792

Fire Fittings & Accessories



### back outlet

**Feature:**

- UL listed and FM approved

Outlet Female NPT Thread	(2) Inlets Female Thread	Cast Brass Part #
4"	2½" NST (NH)	<b>SCS4025F</b>
4"	2½" NST (NH)	<b>ISCS4025F<sup>1</sup></b>

<sup>1</sup> imported

### Dimensions

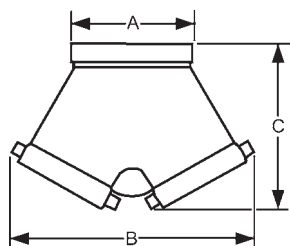

Size	A	B	C
4" x 2½" x 2½"	5⅝"	9"	6-1/16"

- dimensions match SCS4025F and SCS4025NYFD



### bottom outlet

**Feature:**

- UL listed

Outlet Female NPT Thread	(2) Inlets Female Thread	Cast Brass Part #
4"	2½" NST (NH)	<b>90SCS4025F</b>
4"	2½" NST (NH)	<b>90ISCS4025F<sup>1</sup></b>

<sup>1</sup> imported

### Dimensions

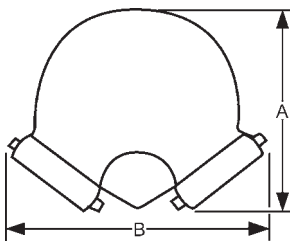

Size	A	B
4" x 2½" x 2½"	6⅞"	9⅞"

- dimensions match 90SCS4025F, and 90SCS4025NYFD

Double Clapper Siamese Connections



Features:

- double drop clapper with (2) pin lug swivel inlets provides required 500 GPM minimum to supplement the fire protection as an auxiliary inlet connection to the water supply (250 GPM minimum per inlet)
- exposed Fire Department Connections (FDC) provide an economical method of satisfying local fire codes
- maximum operating pressure: **175 PSI at 70°F (21°C)**
- finish: -P polished or -C polished chrome plated
- UL listed and FM approved

back outlet

Outlet Female NPT Thread	(2) Inlets Female Thread	Branding	Cast Brass Part #
4"	2½" NST(NH)	AutoSprinkler	<b>DCS4025F</b>
		AutoSprinkler	<b>DCS4025F-P</b>
		AutoSprinkler	<b>DCS4025F-C</b>
		StandPipe	<b>DCS4025F-SP</b>
		No Branding	<b>DCS4025F-NB</b>
6"	2½" NST(NH) 2½" NST(NH)	AutoSprinkler	<b>DCS4030F</b>
		AutoSprinkler	<b>DCS4030NYFD</b>
6"	2½" NST(NH) 2½" NST(NH)	AutoSprinkler	<b>DCS6025F</b>
		StandPipe	<b>DCS6025F-SP</b>



Dimensions

Size	A	B
4" x 2½" x 2½"	9⅝"	12¼"
6" x 2½" x 2½"	10¼"	11¾"
4" x 3" x 3"	10"	12½"
6" x 3" x 3"	10⅝"	12½"

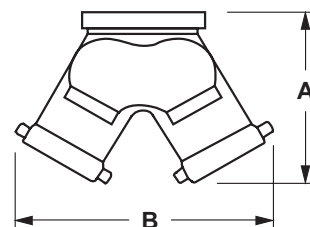

bottom outlet

Outlet Female NPT Thread	(2) Inlets Female Thread	Branding	Cast Brass Part #
4"	2½" NST(NH)	AutoSprinkler	<b>90DCS4025F</b>
		AutoSprinkler	<b>90DCS4025F-P</b>
		AutoSprinkler	<b>90DCS4025F-C</b>
		StandPipe	<b>90DCS4025F-SP</b>
		No Branding	<b>90DCS4025F-NB</b>
6"	2½" NST(NH) 2½" NST(NH)	AutoSprinkler	<b>90DCS4030F</b>
		AutoSprinkler	<b>90DCS4030NYFD</b>
6"	2½" NST(NH) 2½" NST(NH)	AutoSprinkler	<b>90DCS6025F</b>
		AutoSprinkler	<b>90DCS6025F-SP</b>
6"	3" NYFD 3" NYFD	AutoSprinkler	<b>90DCS6030NYFD</b>
		AutoSprinkler	<b>90DCS6030NYFDSP</b>



polished

Dimensions

Size	A	B	C
4" x 2½" x 2½"	11¾"	9⅝"	7¼"
6" x 2½" x 2½"	11¾"	10¾"	7¼"
4" x 3" x 3"	12½"	10⅝"	7½"
6" x 3" x 3"	12¼"	10⅝"	7¼"

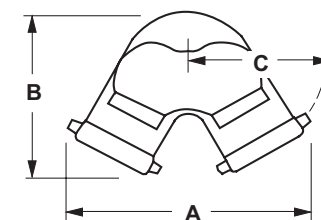

- special threads, branding and finishes are available, consult Dixon® for information
- replacement swivels can be ordered on page 792

Triple Clapper Siamese Connections

Features:

- branding: see below
- finishes: -P polished or -C polished chrome plated
- maximum operating pressure: **175 PSI at 70°F (21°C)**



polished

back outlet

Outlet Female NPT Thread	(3) Inlets Female NST (NH) Thread	Branding	Cast Brass Part #
4"	2½"	AutoSprinkler StandPipe No Branding	<b>TCS4025F</b> <b>TCS4025F-SP</b> <b>TCS4025F-NB</b>
6"	2½"	AutoSprinkler StandPipe No Branding	<b>TCS6025F</b> <b>TCS6025F-SP</b> <b>TCS6025F-NB</b>

Dimensions

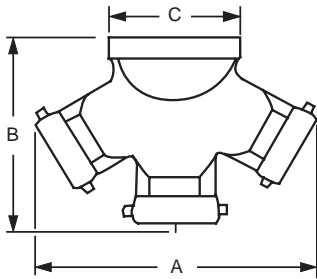

Size	A	B	C
4" x 2½" x 2½" x 2½"	13¾"	10½"	5"
6" x 2½" x 2½" x 2½"	13¾"	10½"	7½"

bottom outlet



Outlet Female NPT Thread	(3) Inlets Female NST (NH) Thread	Branding	Cast Brass Part #
4"	2½"	AutoSprinkler No Branding	<b>90TCS4025F</b> <b>90TCS4025F-NB</b>
6"	2½"	AutoSprinkler No Branding	<b>90TCS6025F</b> <b>90TCS6025F-NB</b>

Dimensions

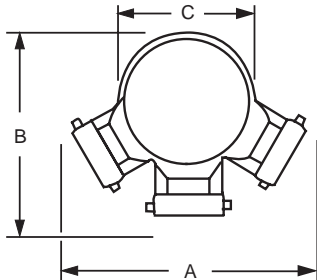

Size	A	B	C
4" x 2½" x 2½" x 2½"	14½"	11½"	7⅝"
6" x 2½" x 2½" x 2½"	14½"	11½"	7⅝"

- special threads, branding and finishes are available, consult Dixon® for information
- replacement swivels can be ordered on page 792

Reversible Concealed Angle Siamese Body



Fire Fittings & Accessories

**Features:**

- fully reversible with a perpendicular trunnion allowing one body to be installed for top and bottom connections
- UL listed
- approved by New York City Board of Standards and Appeals
- maximum operating pressure: **250 PSI at 70°F (21°C)**
- bodies require wall plate **WP2** see page 814

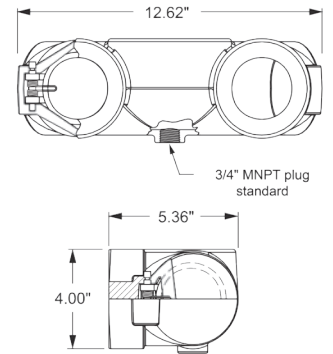

Outlet Female NPT Thread	(2) Inlets Female NPT Thread	Brass Part #
4"	2½"	<b>4025REV90</b>
4"	3"	<b>4030REV90</b>

Reversible Concealed Angle Siamese Body

**Features:**

- fully reversible with a perpendicular trunnion allowing one body to be installed for top and bottom connections
- replaces 23-391 bodies
- maximum operating pressure: **250 PSI at 70°F (21°C)**



Outlet Female NPT Thread	(2) Inlets Female NPT Thread	Brass Part #
5"	2½"	<b>90CREV5025</b>
5"	3"	<b>90CREV5030</b>
6"	2½"	<b>90CREV6025</b>
6"	3"	<b>90CREV6030</b>

Dimensions

Size	A	B	C
5" x 3" x 3"	12"	9½"	7 <sup>5</sup> / <sub>8</sub> "
6" x 2½" x 2½"	12"	7¼"	7 <sup>5</sup> / <sub>8</sub> "
6" x 3" x 3"	12"	9½"	7 <sup>5</sup> / <sub>8</sub> "

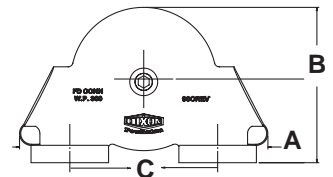



## Concealed Two - Way Wall Hydrant Body

**Features:**

- provides 500 GPM minimums at 250 GPM per inlet (ref NFPA 14)
- drop clappers provide unobstructed waterway
- flush design is desirable when appearance is a factor
- UL listed
- double clapper
- 7<sup>5</sup>/<sub>8</sub>" center-line
- bodies require wall plate **WP2** (24-385), see page 814



**back outlet**

Outlet Female NPT Thread	(2) Inlets Female NPT Thread	Brass Part #
4"	2½"	<b>CDMHCB40225</b>
4"	3"	<b>CDMHCB40230</b>
5"	3"	<b>CDMHCB50230</b>
6"	2½"	<b>CDMHCB60225</b>
6"	3"	<b>CDMHCB60230</b>

**Dimensions**

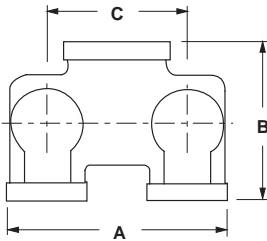

Size	A	B	C
4" x 2½" x 2½"	11-1/8"	6"	7 <sup>5</sup> / <sub>8</sub> "
4" x 3" x 3"	12-1/4"	8-1/8"	7 <sup>5</sup> / <sub>8</sub> "
5" x 3" x 3"	11-13/16"	7-5/16"	7 <sup>5</sup> / <sub>8</sub> "
6" x 2½" x 2½"	11-1/8"	7-3/8"	7 <sup>5</sup> / <sub>8</sub> "
6" x 3" x 3"	12-1/4"	8-1/4"	7 <sup>5</sup> / <sub>8</sub> "

**bottom outlet**



Outlet Female NPT Thread	(2) Inlets Female NPT Thread	Brass Part #
5"	3"	<b>90CDMHCB50230</b>
6"	2½"	<b>90CDMHCB60225</b>
6"	3"	<b>90CDMHCB60230</b>

**Dimensions**

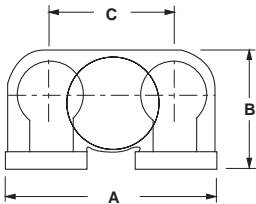

Size	A	B	C
5" x 3" x 3"	12"	9½"	7 <sup>5</sup> / <sub>8</sub> "
6" x 2½" x 2½"	12"	7¼"	7 <sup>5</sup> / <sub>8</sub> "
6" x 3" x 3"	12"	9½"	7 <sup>5</sup> / <sub>8</sub> "

## Spring Check Type Snoots - Pin Lug

**Features:**

- finishes: -P polished, -C polished chrome plated
- other configurations are also available, consult Dixon® for information
- maximum operating pressure: **175 PSI at 70°F (21°C)**

### female outlet

**Features:**

- female NPT rigid with hexagon by female hose thread to swivel
- connections are attached to the bodies with pipe nipples (not included)

Outlet Female NPT Thread	Inlet Female NST (NH) Thread	Cast Brass Part #
3"	2½"	<b>CSSTF25F30T-P</b>
3"	2½"	<b>CSSTF25F30T-C</b>
3"	3"	<b>CSSTF30F30T-P</b>



polished chrome plated

### Dimensions

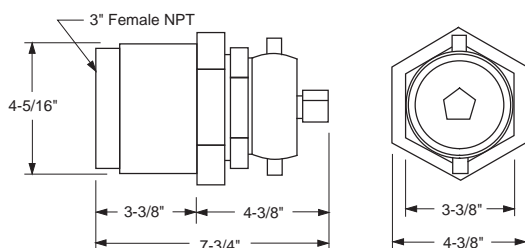

### male outlet

**Features:**

- finishes: -P polished, -C polished chrome plated
- male NPT x 2½" female hose thread to swivel
- used when a direct connection to bodies is desired

Outlet Male NPT Thread	Inlet Female NST (NH) Thread	Cast Brass Part #
3"	2½"	<b>CSSTM25F30T-P</b>
	2½"	<b>CSSTM25F30T-C</b>
	3"	<b>CSSTM30F30T-P</b>
	3"	<b>CSSTM30F30T-C</b>



polished

### Dimensions

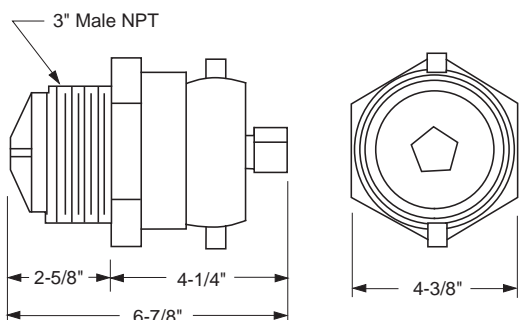

- Under no circumstances should a check snoot be installed directly into a pipe, as this may prevent the snoot from opening. Install directly into the appropriate standpipe body only.





### Clapper Type Snoots - Pin Lug

**Features:**

- finishes: -P polished, -C polished chrome plated
- other sizes and threads are available, consult Dixon® for information



polished chrome plated



polished

Outlet Female NPT Thread	Inlet Female NST (NH) Thread	Cast Brass Part #
3"	2½"	<b>CSCTF25F30T-P</b>
3"	2½"	<b>CSCTF25F30T-C</b>

Outlet Male NPT	Inlet Female NST (NH)	Cast Brass Part #
3"	2½"	<b>CSCTM25F30T-P</b>
3"	2½"	<b>CSCTM25F30T-C</b>

### Wall Plate for Double Clapper Siamese Assemblies

**Features:**

- finishes: -P polished, -C polished chrome plated
- 4-hole and 6-hole wall plates available, consult Dixon® for information



Hole Size	Branding	Brass Part #
3⅝"	AutoSprinkler AutoSprinkler	<b>WP2HAS-P</b> <b>WP2HAS-C</b>
	StandPipe StandPipe	<b>WP2HSP-P</b> <b>WP2HSP-C</b>
	AutoSprinkler StandPipe Combo AutoSprinkler StandPipe Combo	<b>WP2H-ASSP-P</b> <b>WP2H-ASSP-C</b>
	Hydrant	<b>WP2H-HY-P</b>
	PumpTest PumpTest	<b>WP2H-PT-P</b> <b>WP2H-PT-C</b>

Dimensions

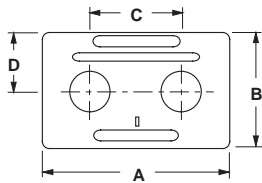

Hole Size	A	B	C	D
3⅝"	14"	8"	7⅞"	4-15/16"

### Wall Plate for Concealed Three Way Bodies

**Features:**

- finishes: -P polished, -C polished chrome plated
- 4-hole and 6-hole wall plates available, consult Dixon® for information



Hole Size	Positioned	Branding	Brass Part #
3⅝"	Horizontal	AutoSprinkler	<b>WP3HAS-P</b>
	Horizontal	AutoSprinkler	<b>WP3HAS-C</b>
	Horizontal	StandPipe	<b>WP3HSP-P</b>
	Horizontal	StandPipe	<b>WP3HSP-C</b>

Dimensions

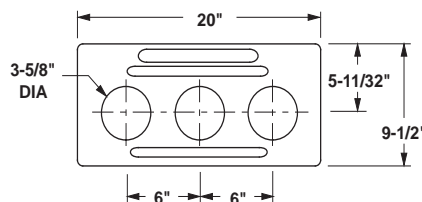



Double Clapper Concealed Type Siamese Assemblies   

**Features:**

- fully reversible with a perpendicular trunnion allowing one body to be installed for top and bottom connections
- branded: 'standpipe', 'auto-sprkr', 'auto-sprkr.-standpipe'
- finishes: -P polished or -C polished chrome plated
- maximum operating pressure: **250 PSI**
- complete unit consisting of the following six parts: (1) 4025REV90, or 4030REV90, or 90CREV6025, (1) 24-385 plate, (2) 23-270 double female connections, (2) 17-127 plugs with chains

Outlet Female NPT Thread	(2) Inlets Female NST (NH) Thread	Branding	Cast Brass Part #
4"	2½"	AutoSprinkler	<b>2WCA4025F-P</b>
4"	2½"	StandPipe	<b>2WCA4025F-SP-P</b>
4"	2½"	AutoSprinkler	<b>2WCA4025F-C</b>
4"	2½"	StandPipe	<b>2WCA4025F-SP-C</b>
4"	3"	AutoSprinkler	<b>2WCA4030F-P</b>
6"	2½"	AutoSprinkler	<b>2WCA6025F-P</b>
6"	2½"	StandPipe	<b>2WCA6025F-SP-P</b>
6"	2½"	AutoSprinkler	<b>2WCA6025F-C</b>
6"	2½"	StandPipe	<b>2WCA6025F-SP-C</b>

- other branding and finishes are also available, consult Dixon® for information



Fire Fittings & Accessories

Two Way Sidewalk Siamese Assemblies   

**Features:**

- UL listed, FM approved
- finishes: -P polished or -C polished chrome plated
- complete unit consists of: (1) 21-133 90° Siamese body, double clapper, (2) 17-127 pin lug plugs with chains, (1) 23-404 sleeve, (1) 24-405 escutcheon plate

Outlet Female NPT Thread	(2) Inlets Female Thread	Cast Brass Part #
4"	2½"	<b>2WSA4025F</b>
4"	2½"	<b>2WSA4025F-SP</b>
6"	2½"	<b>2WSA6025F</b>
6"	2½"	<b>2WSA6025F-SP</b>



Dimensions

Size	A	B	C	E	F
4" x 2½" x 2½"	9¼"	10⅜"	10¾"	10⅜"	6⅝"
6" x 2½" x 2½"	11¼"	10½"	11¾"	13"	7¼"

Note: some components UL listed/FM approved, not entire assembly

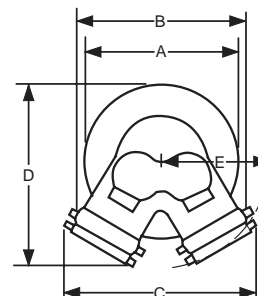

### Single Inlet Residential Sprinkler Connection

Fire Fittings & Accessories



**Application:**

- complete single inlet connection (exposed type) used on residential automatic sprinkler systems

**Features:**

- complete unit consists of: (1) 17-127 1½" pin lug plug with chain and (1) 24-209 4-7/16" OD round escutcheon plate with swivel

Inlet Female NST (NH) Thread	Outlet Female NPT Thread	Cast Brass Part #
1½"	1½"	<b>RIC150F</b>

### Single Inlet Connections

**Features:**

- provides a complete exposed single inlet connection
- finish: -P polished or -C polished chrome plated
- complete unit consists of: (1) 24-209 round plate branded Auto Sprinkler, (1) 23-270 double female or 09-215 male and female connection, (1) 17-127 pin lug plug with chain
- rigid hexagon end of either connection is 2½" NPT
- swivel end



Inlet Female NST (NH) Thread	Outlet Female NPT Thread	Brass Part #
2½"	2½"	<b>SIC250F</b>
2½"	2½"	<b>SIC250F-P</b>
2½"	2½"	<b>SIC250F-C</b>

### Single Hydrant Connection

**Features:**

- finish: -P polished or -C polished chrome plated
- complete unit consists of: (1) 24-209 round plate branded 'Wall Hydrant', (1) 23-272: 2½" female and male connection, (1) 17-126 cap with chain



Inlet Female NPT Thread	Outlet Male NST (NH) Thread	Cast Brass Part #
2½"	2½"	<b>MOCA250F</b>

### Exposed Two Way Wall Hydrants

**Features:**

- finish: -P polished or -C polished chrome plated
- DMOCA40225F consists of: (1) REP400HY round plate branded 'Wall Hydrant', (1) FRC4025F: 2½" female and male connection, (2) FC250F cap with chain
- DMOCA60225F consists of: (1) REP600HY round plate branded 'Wall Hydrant' (1) FRC6025F: 2½" female and male connection, (2) FC250F cap with chain



Inlet Female NPT Thread	(2) Outlets Male NST (NH) Thread	Cast Brass Part #
4"	2½"	<b>DMOCA40225F</b>
6"	2½"	<b>DMOCA60225F</b>

Round **Identification Plates**

**Features:**

- used to trim out and identify exposed fire department connections
- for Siamese, made in 9¼" diameter for 4" pipe and 11¼" diameter for 6" pipe
- finishes: -P polished, -C polished chrome plated

Pipe Size	Branding	Cast Brass Part #
2½"	Auto-Sprinkler	<b>REP250AS</b>
	Auto-Sprinkler	<b>REP250AS-P</b>
	Auto-Sprinkler	<b>REP250AS-C</b>
	Wall Hydrant	<b>REP250HY</b>
	Pump Test	<b>REP250PT</b>
	Standpipe	<b>REP250SP</b>
	Standpipe	<b>REP250SP-P</b>
	Standpipe	<b>REP250SP-C</b>
	4"	Auto-Sprinkler
Auto-Sprinkler		<b>REP400AS</b>
Auto-Sprinkler		<b>REP400AS-P</b>
Auto-Sprinkler		<b>REP400AS-C</b>
Wall Hydrant		<b>REP400HY</b>
Standpipe		<b>REP400SP</b>
Standpipe		<b>REP400SP-P</b>
Standpipe		<b>REP400SP-C</b>
Auto-Sprinkler & Standpipe		<b>REP400AS/SP</b>
6"	Auto-Sprinkler	<b>REP600AS</b>
	Auto-Sprinkler	<b>REP600AS-P</b>
	Auto-Sprinkler	<b>REP600AS-C</b>
	Standpipe	<b>REP600SP</b>
	Standpipe	<b>REP600SP-P</b>
	Standpipe	<b>REP600SP-C</b>

<sup>1</sup> aluminum

Dimensions

Size	OD	Hole Size
2½"	7 <sup>5</sup> / <sub>8</sub> "	3¼"
4"	9¼"	4 <sup>5</sup> / <sub>8</sub> "
6"	11¼"	6 <sup>3</sup> / <sub>4</sub> "



REP250AS-C



REP250AS-P



REP400AS



British Instantaneous Fittings

Features:

- polished finish
- meets BS336 specifications

Fire Fittings & Accessories

Female x female threads



Female BRIT Thread	Female Thread	Brass Part #
2½"	2½" NST (NH) 2½" NPT	<b>BID250F</b> <b>BID250T</b>

Female x male threads



Female BRIT Thread	Male Thread	Brass Part #
2½"	2½" NST (NH) 2½" NPT	<b>BIB250F</b> <b>BIB250T</b>

Male x female threads



Male BRIT Thread	Female Thread	Brass Part #
2½"	2½" NST (NH) 2½" NPT	<b>BIA250F</b> <b>BIA250T</b>

Male x male threads



Male BRIT Thread	Male Thread	Brass Part #
2½"	2½" NST (NH) 2½" NPT	<b>BIF250F</b> <b>BIF250T</b>

British Instantaneous Fittings

Hose Shanks

Size	Brass Part #
2½" male BRIT x 1½" hose shank	<b>BIE150</b>
2½" male BRIT x 2½" hose shank	<b>BIE250</b>
2½" female BRIT x 1½" hose shank	<b>BIC150</b>
2½" female BRIT x 2½" hose shank	<b>BIC250</b>



BIE150



BIC150

Fire Fittings & Accessories

Plug

Size	Brass Part #
2½"	<b>BIDP250</b>



Cap

Size	Brass Part #
2½"	<b>BIDC250</b>



International Shore Connections

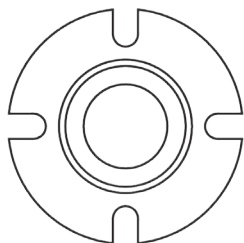

ship connection  
09-319

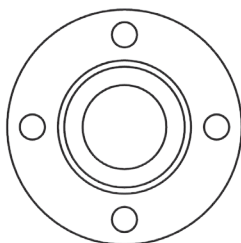

shore connection  
09-318

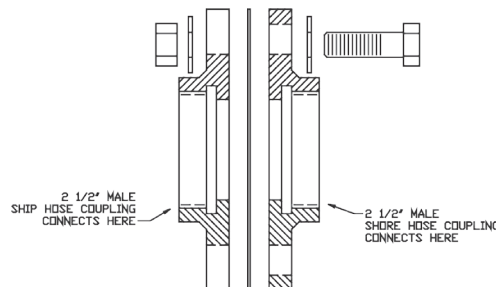

Features:

- meets US Coast Guard specifications for vessels 1000 gross tons or more
- makes possible the connection of two different threads between ship and shore or between ships
- 7" OD brass flange with 4¾" holes
- includes 8 washers, 4 hexagon brass nuts, 4 hex head bolts, 1 washer, 1 fiber gasket
- working pressure: **300 PSI**
- NST (NH) threads standard, also available in NPT and NYFD threads

Description	Brass Part #
shore side	<b>09-318-00001</b>
ship side	<b>09-319-00001</b>



shore side



ship side

### Pick Head Fire Axe



**Features:**

- red trim
- 36" hickory handle
- listed in the minimum requirements approval guides for outfitting hose houses and hose cabinets by insurance underwriters

Description	Part #
6 lb. axe	<b>PHFA6</b>
axe brackets	<b>PHFA-B-A</b>



### Sprinkler Line Tester



**Feature:**

- installs on the last sprinkler head on system branch lines and controls water flow for flushing or testing the system

Inlet	Outlet	Brass Part #
1" female NPT	1" male NPSH	<b>SLT10050</b>

Domestic Cast Angle Valves



Features:

- UL listed and FM approved
- aluminum hand wheel
- working pressure: **300 PSI at 70°F (21°C)**

Female x Male

Inlet Female NPT	Outlet Male Thread	Cast Brass Part #
1½"	1½" NST (NH)	<b>AV150</b>
	1½" NPSH	<b>AV150S</b>
	1½" NPT	<b>AV150T</b>
2½"	2½" NST (NH)	<b>AV250</b>
	2½" NYFD	<b>AV250NYFD<sup>1</sup></b>



<sup>1</sup> supplied with red hand wheel

Female x Female

Inlet Female NPT	Outlet Female NPT	Cast Brass Part #
1½"	1½"	<b>AVF150</b>
2½"	2½"	<b>AVF250</b>



Replacement Parts

Description	Part #
aluminum handwheel for 1½" valve	<b>AV150-W</b>
aluminum handwheel for 2½" valve	<b>AV250-W</b>
handwheel nut for 1½" valve	<b>AV150-N</b>
handwheel nut for 2½" valve	<b>AV250-N</b>
valve seal rubber for 1½" valve	<b>AV150-RBR</b>
valve seal rubber for 2½" valve	<b>AV250-RBR</b>

Dimensions

Size	A	B	C closed	C open	D	F
1½"	2-11/64"	2-7/32"	6⅝"	7-21/32"	3¾"	2-13/16"
2½"	3-3/16"	3-3/16"	9¼"	11"	5"	3-19/32"

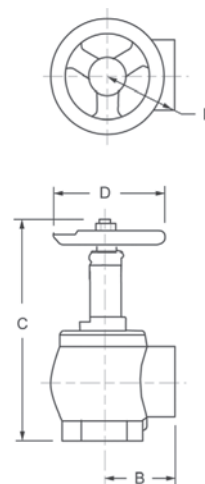



### Grooved Angle Valves

**Application:**  
 • commercial fire protection

**Features:**  
 • made in the USA  
 • easy for contractor to install  
 • groove inlet  
 • Buna-N gasket  
 • working pressure: **300 PSI at 70°F (21°C)**  
 • UL listed, FM approved, ULC approved

Description	Cast Brass Part #
groove x male	<b>AVG250F</b>
groove x groove	<b>AVG250G</b>
groove x female	<b>AVGF250</b>



### 500# Angle Hose Valves

**Applications:**  
 • fire department, gravity and pressure tank connections, test connections, and public water supplies to sprinkler and standpipe systems where it is necessary to access the system for a fire hose connection

**Features:**  
 • designed and approved to manage 500 PSI pressures in piping systems  
 • red handwheel  
 • FM approved  
 • New York City Board of Standards and Appeals, approval # MEA 54-07-E  
 • maximum operating pressure: **500 PSI at 70°F (21°C)**

#### Female x Male



Inlet Female NPT	Outlet Male Thread	Cast Brass Part #
2½"	2½" NST (NH)	<b>AV5-250F</b>
2½"	2½" NYFD	<b>AV5-250NYFD</b>

#### Female x Female



Inlet Female NPT	Outlet Female NPT	Cast Brass Part #
2½"	2½"	<b>AVF5-250</b>





**Features:**

- NPT inlet thread only
- aluminum handwheel
- working pressure: **300 PSI at 70°F (21°C)**
- UL listed and FM approved
- New York City Board of Standards and Appeals, approval # MEA 54-07-E
- available finishes:
  - cast (standard)
  - polished: -P
  - chrome: -C
  - minimum quantity for special thread, consult Dixon®

**Female Inlet**

Inlet Female NPT	Outlet Male Thread	Cast Yellow DZR Brass Part #
1½"	1½" male NST (NH)	<b>AV150-I</b>
2½"	2½" male NST (NH)	<b>AV250-I</b>
2½"	2½" MNYFD	<b>AV250NYFD-I</b>



**Double Female**

**Features:**

- NPT inlet and outlet
- aluminum handwheel
- working pressure: **300 PSI at 70°F (21°C)**
- New York City Board of Standards and Appeals, approval # MEA 54-07-E
- available finish:
  - cast (standard)
  - polished = -P
  - chrome = -C

Inlet Female NPT	Outlet Female NPT	Cast Yellow DZR Brass Part #
1½"	1½"	<b>AVF150-I</b>
2½"	2½"	<b>AVF250-I</b>



**Dimensions**

Size	A	B	C closed	C open	D	E	Wt. in Lbs.
1½"	4.13"	3.75"	6.80"	7.78"	2.25"	1.81"	4.4
2½"	5.69"	5.00"	9.00"	10.72"	3.19"	2.59"	9.5

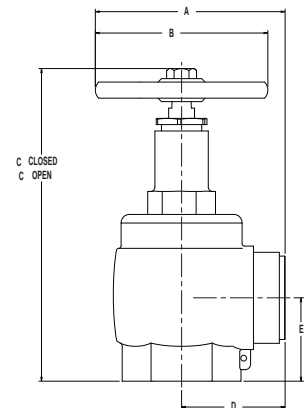



## Global Forged Angle Hose Valves

**Features:**

- to be used with a fire hose rack assembly, or as a fire department outlet connection
- UL listed and FM approved
- red steel handwheel
- maximum operating pressure: **300 PSI at 70°F (21°C)**
- polished or chrome plated parts with other outlet threads are also available, consult Dixon® for information

**Female x Male**



Inlet Female NPT	Outlet Male Thread	Forged Brass Part #
1½"	1½" NST (NH)	<b>AV151</b>
2½"	2½" NST (NH)	<b>AV251</b>
	2½" NYC	<b>AV251NYC</b>
	2½" NYFD	<b>AV251NYFD</b>

**Female x Female**



Inlet Female NPT	Outlet Female NPT	Forged Brass Part #
1½"	1½"	<b>AVF151</b>
2½"	2½"	<b>AVF251</b>

**Replacement Parts**



Description	Part #
handwheel for 1½" valve	<b>AV151-WR</b>
handwheel for 2½" valve	<b>AV251-WR</b>
handwheel nut for 1½" and 2½" valve	<b>AV251-N</b>
valve seal rubber for 1½" valve	<b>AV151-RBR</b>
valve seal rubber for 2½" valve	<b>AV251-RBR</b>

## Non-rising Stem Wedge Disc Gate Valves



**Features:**

- red iron handwheel, with brass cap and chain
- cap not included on the NYFD threaded valve and special threaded valves
- solid wedge disc with tapered seats
- 2½" UL listed and FM approved
- FM approved
- working pressure: **300 PSI at 70°F (21°C)**
- other configurations are available, contact Dixon® for additional information

Inlet Female NPT	Outlet Male Thread	UL Listed	Cast Brass Part #
1½"	1½" NST (NH)	no	<b>WDGV150F</b>
2½"	2½" NST (NH)	yes	<b>WDGV250F</b>
2½"	2½" NYFD	yes	<b>WDGV250NYFD</b>



Fire Fittings & Accessories

### Dimensions

Size	A	B	C	D
1½"	3-49/64"	5⅝"	1⅞"	6⅝"
2½"	6"	10¾"	2½"	13¼"

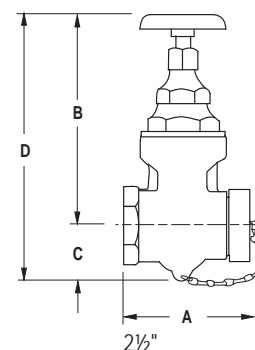

## Global Non-rising Stem Wedge Disc Gate Valves



**Features:**

- working pressure: **300 PSI (2069 kPa)**
- custom male thread available
- UL listed and FM approved
- non-rising stem
- cast brass with solid wedge disc and tapered seats
- red iron wheel handle with cap and chain (cap not supplied on non-standard threads)
- alloy = DZR brass
- furnished with 2½" NST brass cap and chain
- available finishes:
  - cast (standard)
  - polished trim - P
  - cast chrome - RC
  - polished chrome trim - C

Inlet Female NPT	Outlet Male NST	UL Listed	Cast DZR Brass Part #
2½"	2½"	yes	<b>GWDGV250F</b>



### Dimensions

Size	A	B	C	D
2½"	5"	7¾"	2½"	10"

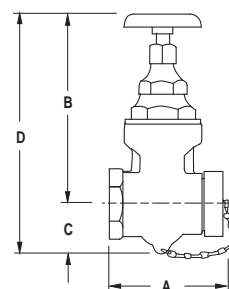



## Non-rising Stem Wedge Disc Gate Valves



**Applications:**

- for use on standpipes, fire pumps and hydrants

**Features:**

- satin finish
- red handwheel
- solid wedge disc with tapered seats
- straightway pattern
- UL listed and FM approved
- working pressure: **300 PSI at 70°F (21°C)**

Inlet Female NPT	Outlet Male NST (NH)	Forged Brass Part #
2½"	2½"	<b>WDGV251F</b>
3"	2½"	<b>WDGV3025F</b>

## Rising Stem Wedge Disc Gate Valves



**Features:**

- red iron handwheel, with brass cap and chain
- solid wedge disc with tapered seats
- not recommended for wet standpipe systems, use AV250 (18-157) for this purpose, see page 821
- other configurations are available, contact Dixon® for additional information



Inlet Female NPT	Outlet Male	Working Pressure PSI	Cast Brass Part #
2½"	2½" NST (NH)	<b>200</b>	<b>RWDGV250F</b>
3"	2½" NST (NH)	<b>300</b>	<b>RWDGV3025F<sup>1</sup></b>

<sup>1</sup> UL listed

### Dimensions

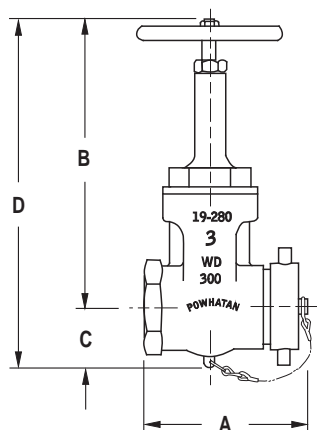

Size	A	B closed	C	D closed	D open
2½"	6½"	11	2½"	13½"	16¼"
3" x 2½"	6-3/16"	11	2½"	13½"	16¼"



## Single Hydrant Gate Valves with Hand Wheel

**Application:**

- used to throttle the flow from a fire hydrant preventing damage to the hydrant

**Features:**

- O-ring seal
- UL listed
- for use on standpipes and fire pumps where UL listing is required
- maximum operating pressure: **175 PSI** (water only) at **70°F (21°C)**
- other configurations are available, contact Dixon® for additional information

Inlet Female	Outlet Male	Cast Red Brass Part #
2½" NST (NH)	2½" NST (NH)	<b>UHGV250F</b>
2½" NST (NH)	2½" NST (NH)	<b>UHGV250F-D</b>



Fire Fittings & Accessories

### Replacement Part

Description	Part #
handwheel	<b>UHGV250-W</b>



## Single Hydrant Gate Valves with Speed Handle

**Application:**

- used to throttle the flow from a fire hydrant preventing damage to the hydrant

**Features:**

- pin lug swivel, non-rising stem, aluminum speed handle
- rubber seal
- for use on hydrants, standpipes, and fire pumps
- maximum operating pressure: **175 PSI** (water only) at **70°F (21°C)**
- other configurations are available, contact Dixon® for additional information

Inlet Female	Outlet Male	Cast Red Brass Part #
2½" NST (NH)	2½" NST (NH)	<b>HGV250F</b>
2½" NST (NH)	2½" NST (NH)	<b>HGV250F-D</b>
2½" NST (NH)	2½" NPSH	<b>HGV250</b>



### Replacement Part

Description	Aluminum Part #
speed handle	<b>HGV250-H</b>





### Single Hydrant Gate Valves with Handwheel

**Application:**

- protects fire hydrants from damage that can occur if they are used for throttling

**Features:**

- pin lug swivel, non-rising stem, red handwheel
- metal to metal seal
- UL listed
- for use on hydrants, standpipes, and fire pumps
- maximum operating pressure: **300 PSI** (water only) at **70°F (21°C)**



Inlet Female	Outlet Male	Forged Brass Part #
2½" NST (NH)	2½" NST (NH)	<b>HGVW250F</b>

**Replacement Part**



Description	Part #
handwheel	<b>HGVW250-W</b>

### Hydrant Gate Valves with Speed Handle

**Features:**

- protects fire hydrants from damage that can occur if they are used for throttling
- full 2½" waterway
- anodized throughout - minimum thickness 0.001"
- test pressure: **250 PSI**, working pressure: **100 PSI** at **70°F (21°C)**



Inlet Female Swivel	Outlet Male	Aluminum Alloy, 356-T6 Part #
2½" NPSH	2½" NPSH	<b>AHGV250</b>
2½" NST (NH)	2½" NST (NH)	<b>AHGV250F</b>

**Replacement Part**



handwheel and knob

Description	Part #
handwheel and knob	<b>HGV-HDWHL</b>
knob only	<b>HGV-KNOB</b>

### Global Hydrant Gate Valves with Speed Handle

**Application:**

- protects fire hydrants from damage that can occur if they are used for throttling

**Features:**

- pin lug swivel, non-rising stem, aluminum speed handle
- non-metallic seal
- maximum operating pressure: **175 PSI** (water only) at **70°F (21°C)**



Inlet Female NST (NH)	Outlet Male NST (NH)	Aluminum Alloy Part #
2½"	2½"	<b>AHGV250F-I</b>

**Replacement Part**



Description	Aluminum Part #
speed handle	<b>AHGV250F-H</b>

## Large Diameter (LDH) Gate Valves

**Application:**

- used on the suction intake and discharge sides of a pumper or on a hydrant

**Features:**

- 30° elbow needs only 8 easy turns to open and close
- non-rising stem, with an air bleed off
- finish anodized throughout - minimum thickness 0.001"
- maximum operating pressure: **280 PSI at 70°F (21°C)**, without relief valve
- 4½" minimum waterway

### Storz x Storz

Inlet Storz	Outlet Storz	Length	Width	Height	Aluminum Alloy, 356-T6 Part #
4"	4"	9"	6¼"	19½"	<b>SGV440</b>
4"	5"	9"	7¾"	19½"	<b>SGV450</b>
5"	4"	9"	7¾"	19½"	<b>SGV540</b>
5"	5"	9"	7¾"	19½"	<b>SGV550</b>

- all measurements include handles



### Storz x Storz 30° with Air Bleeder

Inlet Storz	Outlet Storz	Length	Width	Height	Aluminum Alloy, 356-T6 Part #
4"	4"	9"	6¼"	20.0"	<b>SGV30-440</b>
4"	5"	9"	7¾"	20.0"	<b>SGV30-450</b>
5"	4"	9"	7¾"	20.0"	<b>SGV30-540</b>
5"	5"	9"	7¾"	20.0"	<b>SGV30-550</b>

- all measurements include handles



### Storz x Female Swivel

Inlet Storz	Outlet Female NST Swivel	Length	Width	Height	Aluminum Alloy, 356-T6 Part #
4"	4"	9"	6"	19½"	<b>FSGV440F</b>
	4½"	9"	6½"	19½"	<b>FSGV445F</b>
	5"	9"	7"	19½"	<b>FSGV450F</b>
	6"	9"	8"	19½"	<b>FSGV460F</b>
5"	4"	9"	6"	19½"	<b>FSGV540F</b>
	4½"	9"	6½"	19½"	<b>FSGV545F</b>
	5"	9"	7"	19½"	<b>FSGV550F</b>
	6"	9"	8"	19½"	<b>FSGV560F</b>

- all measurements include handles



### Wharf Hydrants



**Features:**

- used to provide a fire department outlet connection
- pentagon nut at top of spindle discourages unauthorized use
- hydrostatically tested
- maximum operating pressure: **300 PSI at 70°F (21°C)**

Inlet Female NPT	Outlet Male NST (NH)	Height Open	Height Closed	Cast Brass Part #
3"	2½"	16.38	14.25	<b>WHYD3025F</b>
4"	2½"	16.38	14.25	<b>WHYD4025F</b>
4"	4½"	18.13	15.63	<b>WHYD4045F</b>

### Replacement Parts



hand wheel



pentagon hex nut

Description	Part #
optional hand wheel	<b>46-030-00025</b>
pentagon hex nut	<b>44-251-00006</b>

### Forestry Grade ¼ Turn Ball Type Wye Valves



1" - 1½"

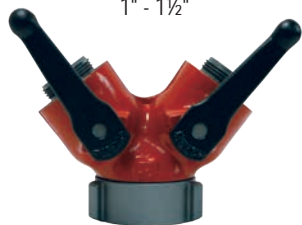

2½"

**Features:**

- cast aluminum swivel inlet, anodized body, hard-coated threads
- built to US Forest Service specifications
- 1" and 1½" for use up to **600 PSI** (water/AFFF only); 2½" for use up to **400 PSI** (water/AFFF only)

Female Thread	(2) Male Threads	Cast Aluminum Part #
1" NPSH	1" NPSH	<b>FWV10S10S</b>
1½" NPSH	1½" NPSH	<b>FWV15S15S</b>
1½" NST (NH)	1½" NST (NH)	<b>FWV15F15F</b>
2½" NST (NH)	1½" NST (NH)	<b>FWV25F15F</b>
2½" NST (NH)	2½" NST (NH)	<b>FWV25F25F</b>



### ¼ Turn Ball Type Wye Valve

**Features:**

- rocker lug swivel
- operates easily under high pressure
- handles are not field replaceable
- seals on the ball are field adjustable and field replaceable
- maximum operating pressure: **175 PSI** (water only) at **70°F (21°C)**

**Specification:**

- meets NSN specifications # 4210-00-255-0234

Inlet Female	(2) Outlets Male	Cast Brass Part #
2½" NST (NH)	1½" NPSH	<b>S7337S</b>



### Full Flow ¼ Turn Ball Type Wye Valves

**Features:**

- recommended for charged pre-connected hose lines
- pin lug swivel
- maximum operating pressure: **175 PSI** (water only) at **70°F (21°C)**
- other configurations are available, contact Dixon® for additional information

Inlet Female Swivel	(2) Outlets Male	Cast Brass Part #
1½" NPSH	1½" NPSH	<b>S7100-15S</b>
1½" NST (NH)	1½" NST (NH)	<b>S7100-15</b>
2½" NST (NH)	1½" NST (NH)	<b>S7100</b>



### Leader Line ¼ Turn Ball Type Wye Valve

**Features:**

- body painted red with chrome trim
- maximum operating pressure: **400 PSI** (water only) at **70°F (21°C)**

Inlet Female NST (NH)	(2) Outlets Male NST (NH)	Brass Part #
2½"	1½"	<b>LLBV2515F</b>



### ¼ Turn Plug Type Wye Valves

**Features:**

- pin lug swivel
- maximum operating pressure: **175 PSI** (water only) at **70°F (21°C)**
- not recommended for charged pre-connected hose 

Inlet Female NST (NH)	(2) Outlets Male	Cast Brass Part #
2½"	1½" NST (NH)	<b>S6175</b>
2½"	1½" NPSH	<b>S6175S</b>

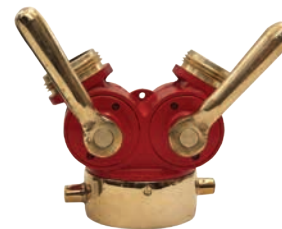

2-Way Ball Valves

Fire Fittings & Accessories



1/2"



2 1/2"



3" - 6"

Inlet Female Swivel	(2) Outlet Male	Aluminum Part #
1 1/2" NST (NH)	1 1/2" NST (NH)	<b>FMBV15F15F</b>
1 1/2" NPSH	1 1/2" NPSH	<b>FMBV15S15S</b>
2 1/2" NST (NH)	1 1/2" NST (NH)	<b>FMBV25F15F</b>
2 1/2" NST (NH)	2 1/2" NST (NH)	<b>FMBV25F25F</b>
4" NST (NH)	2 1/2" NST (NH)	<b>FMBV40F25F</b>
4 1/2" NST (NH)	2 1/2" NST (NH)	<b>FMBV45F25F</b>

Plain Wyes with Pin Lugs

Features:

- divides one stream into two
- other configurations are available, contact Dixon® for additional information



Inlet Female	(2) Outlets Male	Cast Brass Part #
1 1/2" NST (NH)	1 1/2" NST (NH)	<b>PW15F15F</b>
1 1/2" NPSH	1 1/2" NPSH	<b>PW15S15S</b>
2 1/2" NST (NH)	1 1/2" NST (NH)	<b>PW25F15F</b>
2 1/2" NST (NH)	2 1/2" NST (NH)	<b>PW25F25F</b>

## Straight Globe Valves

**Features:**

- ideal for wet and combination systems
- used with a fire hose rack assembly, or as a fire department outlet connection
- aluminum handwheel
- maximum operating pressure: **300 PSI at 70°F (21°C)**

**Female x Male**

Inlet Female NPT	Outlet Male NST (NH)	Cast Brass Part #
1½"	1½"	<b>SGV150F</b>
2½"	2½"	<b>SGV250F</b>



**Female x Female**

Inlet Female NPT	Outlet Female NPT	Cast Brass Part #
1½"	1½"	<b>SGVF150</b>
2½"	2½"	<b>SGVF250</b>



**Dimensions**

Size	A	B	C closed	D open
1½"	2¾"	4¾"	7¼"	8"
2½"	3-9/32"	6-9/16"	7¾"	8⅝"

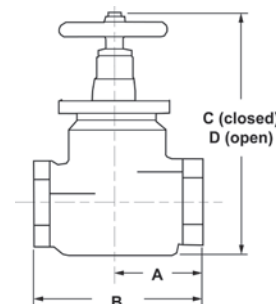

## Angled Ball Drip Valves

**Features:**

- seals automatically under pressure
- installed horizontally, the ball seats at approximately **8-10 PSI**
- working pressure: **175 PSI at 70°F (21°C)**

Male NPT	Male NPT	Brass Part #
½"	½"	<b>ASBDV50</b>
¾"	¾"	<b>ASBDV75</b>

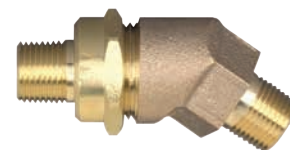

## Straight Ball Drip Valves

**Application:**

- designed to drain the low point of a system

**Features:**

- place valve between a fire department connection and a swing check valve
- seals automatically under pressure
- install horizontally
- working pressure: **175 PSI at 70°F (21°C)**

Male NPT	Male NPT	Brass Part #
½"	½"	<b>SBDV50</b>
¾"	¾"	<b>SBDV75</b>



Factory Set Pressure Reducing Brass Angle Valves



Fire Fittings & Accessories

**Features:**

- true combination shut-off and pressure reducing valves
- 1½" reduces inlet pressure of 300 PSI (2069 kPa) or less to working pressures of **10 through 175 PSI** (69-1207 kPa); 2½" reduces inlet pressures of 400 PSI (2758 kPa) or less to working pressures of **20 through 175 PSI** (138-1207 kPa) under discharge or static conditions
- female x female valves have an open / closed indicator bonnet for confirmation of status
- tamper resistant and automatic
- available with a tamper proof switch
- all debris must be flushed from the system prior to being placed into service 
- complete switch, bracket and housing available for field mounting, consult Dixon® for price and availability
- other configurations are available, contact Dixon® for additional information

**Specifications:**

- UL listed for Automatic Sprinkler Systems as floor or zone control valves
- Standpipe Systems, Class I, II and III
- Automatic Check Valve for Dual Riser Systems
- Approved by New York City Board of Standards and Appeals, approval # MEA 54-07-E
- Approved by City of Los Angeles and the City of San Francisco (ULC 2½")



**Female x Male**

Inlet Female NPT	Outlet Male NST (NH)	Cast Brass Part #
1½"	1½"	<b>NAPRAV150F-15</b> <b>NAPRAV150F-20</b> <b>NAPRAV150F-25</b> <b>NAPRAV150F-30</b> <b>NAPRAV150F-35</b>
2½"	2½"	<b>NAPRAV250F-55</b> <b>NAPRAV250F-60</b> <b>NAPRAV250F-65</b> <b>NAPRAV250F-70</b> <b>NAPRAV250F-75</b> <b>NAPRAV250F-80</b>

**Female x Female**



Inlet Female NPT	Outlet Female NPT	Cast Brass Part #
1½"	1½"	<b>NAPRAVF150-15</b> <b>NAPRAVF150-20</b> <b>NAPRAVF150-25</b> <b>NAPRAVF150-30</b> <b>NAPRAVF150-50</b>
2½"	2½"	<b>NAPRAVF250-55</b> <b>NAPRAVF250-60</b> <b>NAPRAVF250-65</b> <b>NAPRAVF250-70</b> <b>NAPRAVF250-75</b> <b>NAPRAVF250-80</b>

**Dimensions**

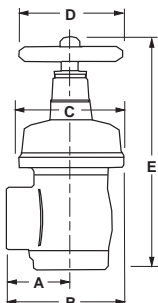

Size	A	B	C	D	E closed	E open
1½"	2-7/32"	4-5/32"	3 7/8"	3 3/4"	9-25/64"	8-53/64"
2½"	3-7/32"	6-3/32"	5 3/4"	5 3/4"	11 1/8"	10-13/16"

Factory Set Pressure Reducing Brass Standard Globe Valve



Fire Fittings & Accessories

Female x Female

Inlet Female NPT	Outlet Female NPT	Cast Brass Part #
2½"	2½"	<b>NAPRVF250-55</b> <b>NAPRVF250-60</b> <b>NAPRVF250-65</b> <b>NAPRVF250-70</b> <b>NAPRVF250-75</b> <b>NAPRVF250-80</b>



Grooved x Grooved

Inlet Grooved	Outlet Grooved	Cast Brass Part #
2½"	2½"	<b>NAPRVGT250-55</b> <b>NAPRVGT250-60</b> <b>NAPRVGT250-65</b> <b>NAPRVGT250-70</b> <b>NAPRVGT250-75</b>



Dimensions

Size	Style	A	B	C	D	E closed	E open
2½"	NPT	3⅞"	7¾"	5¾"	5¾"	12¾"	12-13/16"
2½"	grooved	4⅜"	8¾"	5¾"	5¾"	12¾"	12-13/16"

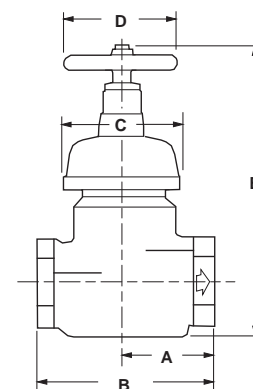

Accessories

Description	Part #
2½" tamper switch bracket kit (bonnet, nut, switch, bracket)	<b>4201901587</b>
switch bracket only	<b>18-458-00017</b>
replacement handles for 1½" valves	<b>AV150-W</b>
replacement handles for 2½" valves	<b>46-030-00025</b>

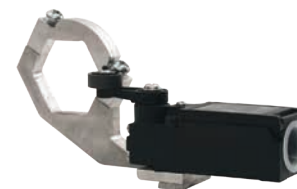

Factory Set Pressure Reducing (regulating) Valves



Fire Fittings & Accessories

Features:

- (4) drilled and tapped bosses:
  - two on each side for upstream and downstream pressure monitoring
  - saves installation time and provides a cleaner appearance
- 2½" size reduces inlet pressures of **400 PSI** (2758 kPa) or less to desired working pressures from **20** through **175 PSI** (138-1207 kPa) under discharge or static conditions
- UL listed
- tamper switch available

Angle Grooved x Grooved



Inlet Grooved	Outlet Grooved	Cast Brass Part #
2½"	2½"	NAPRAVGT250-55 NAPRAVGT250-60 NAPRAVGT250-65 NAPRAVGT250-70 NAPRAVGT250-75 NAPRAVGT250-80 NAPRAVGT250-85 NAPRAVGT250-95

Angle Grooved x Female



Inlet Grooved	Outlet Female NPT	Cast Brass Part #
2½"	2½"	NAPRAVGF250-55 NAPRAVGF250-60 NAPRAVGF250-65 NAPRAVGF250-70 NAPRAVGF250-75 NAPRAVGF250-80 NAPRAVGF250-85 NAPRAVGF250-95

Globe Female x Female



Inlet Female NPT	Outlet Female NPT	Cast Brass Part #
2½"	2½"	NAPRVFT250-55 NAPRVFT250-60 NAPRVFT250-65 NAPRVFT250-70 NAPRVFT250-75 NAPRVFT250-80 NAPRVFT250-85

Globe Grooved x Grooved



Inlet Grooved	Outlet Grooved	Cast Brass Part #
2½"	2½"	NAPRVGT250-55 NAPRVGT250-60 NAPRVGT250-65 NAPRVGT250-70 NAPRVGT250-75 NAPRVGT250-80 NAPRVGT250-85

Dimensions

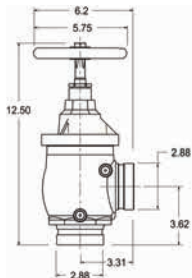

grooved x grooved angle valve

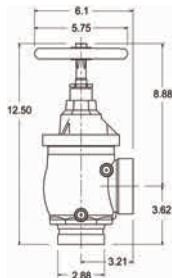

grooved x female angle valve

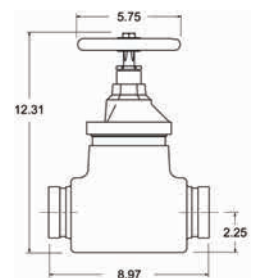

grooved x grooved globe valve

Field Adjustable Pressure Reducing Valves



**Features:**

- UL listed
- allows flexibility during installation with the ability to adjust settings once installed as hydraulic conditions change
- used in applications where the inlet pressure is greater than **175 PSI**
- ¼" NPT gauge ports - both sides, drilled and tapped standard
- ⅜" adjusting rod included

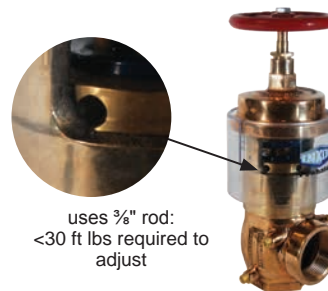

**Angle Valves**

Inlet	Outlet	Cast Brass Part #
2½" FNPT	2½" MNST	<b>FAPRAV250F</b>
2½" FNPT	2½" FNPT	<b>FAPRAVF250</b>
2½" groove	2½" MNST	<b>FAPRAVG250F</b>
2½" groove	2½" groove	<b>FAPRAVG250G</b>



**Straight Valves**

Inlet	Outlet	Cast Brass Part #
2½" groove	2½" groove	<b>FAPRVG250</b>
2½" FNPT	2½" FNPT	<b>FAPRVF250</b>



**Replacement Parts**

Description	Cast Iron Part #
handwheel	<b>46-030-00025</b>

**Setting Instructions:**

1. Determine desired outlet pressure for known inlet pressure.
2. Remove the tamper-resistant screw and slide the plastic cover up to access the adjusting nut.
3. Use a ⅜" diameter rod in any one of the 6 holes in the adjusting nut and rotate counter clockwise to increase the pressure at the outlet.
4. Check valve under pressure under static and under the anticipated flowing conditions to ascertain that the setting produces the expected results.



Adjustable Pressure Restricting Devices



**Features:**

- for installation on Class I or Class III standpipe system hose outlets
- device restricts pressure in the piping system to such a degree that hose lines can be handled by persons untrained in the handling of heavy fire streams
- New York City Board of Standards and Appeals, approval # MEA 54-07-E
- 2½" UL listed
- working pressure: **175 PSI at 70°F (21°C)**

Female Thread	Male Thread	Cast Brass Part #
1½" NST (NH)	1½" NST (NH)	<b>APRD150F</b>
2½" NST (NH)	2½" NST (NH)	<b>APRD250F</b>





## Domestic Adjustable Pressure Restricting Angle Valves



**Application:**

- used where flowing water pressure needs to be controlled

**Features:**

- preset orifices restrict the volume of water thereby lowering the pressure of the flowing water; NFPA requires restricting valves where inlet pressure exceeds 100 PSI
- restricting valve has no effect on the static pressure of a system
- can be manually by-passed if required by opening the valve fully, this is accomplished by breaking the breakable link, which allows the valve stem to rise to the full open position
- breakable link also serves as an indication of valve condition and status; if valve is opened without breaking the link it will resume its previous position and no resetting is necessary
- restricts inlet pressure from 70 PSI up to a maximum of 175 PSI
- restricts down to outlet pressures of 65, 80 or 100 PSI, outlet pressures may be set below 65 PSI when authorized by the local authority having jurisdiction
- restricts only under flow conditions
- setting charts are packed with valve
- UL listed
- New York City Board of Standards and Appeals, approval # MEA 54-07-E
- maximum operating pressure: up to **175 PSI**
- aluminum handwheel
- other configurations are available, contact Dixon® for additional information

**Female x Male**

Inlet Female NPT	Outlet Male NST (NH)	Cast Brass Part #
1½"	1½"	<b>AVAPR150F</b>
2½"	2½"	<b>AVAPR250F</b>

**Female x Female**

Inlet Female NPT	Outlet Female NPT	Cast Brass Part #
1½"	1½"	<b>AVAPRF150</b>
2½"	2½"	<b>AVAPRF250</b>



## Global Adjustable Pressure Restricting Angle Valves



**Application:**

- used when flowing water pressure needs to be controlled

**Features:**

- preset orifices restrict the volume of water thereby lowering the pressure of the flowing water; NFPA requires restricting valves where inlet pressure exceeds 100 PSI
- restricting valve has no effect on the static pressure of a system
- restricting device can be manually by passed if required by opening the valve fully: pull the pin allowing the yoke to fall back from the valve stem which allows valve to be fully opened, when valve needs to be restricted again, slide the yoke back into place to be NFPA compliant

**Female x Male**

Inlet Female NPT	Outlet Male NST (NH)	Cast Brass Part #
1½"	1½"	<b>AVAPR150F-I</b>
2½"	2½"	<b>AVAPR250F-I</b>

**Female x Female**

Inlet Female NPT	Outlet Female NPT	Cast Brass Part #
1½"	1½"	<b>AVAPRF150-I</b>
2½"	2½"	<b>AVAPRF250-I</b>



Back Flow Preventer



Features:

- provides maximum protection against backflow caused by back-pressure or back-siphonage from a cross-connection wherein a contaminant hazard exists
- consists of two spring-loaded poppet type check valves and a mechanically independent, hydraulically dependent pressure differential relief valve
- three top mounted test cocks ensure easy access during repair and maintenance
- working pressure: to **175 PSIG**
- temperature range: **33°F to 180°F (.5°C to 82°C)**
- meets Foundation for Cross Connection Control and Hydraulic Research at University of Southern California Manual Section 10, ASSE 1015, AWWA C-510 and CSA B64.4 specifications
- UL listed and FM approved
- create a Fire Hydrant Backflow Preventer by using the **RSMSA25F20T** (page 780) and the **DMH2025F** (page 782)

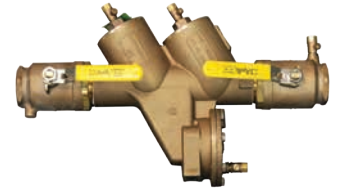

Fire Fittings & Accessories

NPT Thread	Brass Part #
2"	<b>BFP200</b>

Chicago Pattern Valves

Features:

- aluminum handwheel
- maximum operating pressure: **175 PSI at 70°F (21°C)**



Inlet Male NPT	Outlet Male	Cast Brass Part #
1½"	1½" NST (NH)	<b>CPV150F</b>



### Sprinkler Hose Valve



**Features:**

- aluminum wheel
- UL listed and FM approved for automatic sprinkler and standpipe systems
- working pressure: **175 PSI** (water only) at **70°F (21°C)**

Inlet Male NPT	Outlet Male NST (NH)	Cast Brass Part #
1"	1½"	<b>ASHV1015F</b>

### Push Pull Drain Valve



**Features:**

- direct mount
- 2½" handle length

Inlet	Outlet	Brass Part #
¾" FNPT	¾" FNPT	<b>PPDV75</b>

### Automatic Drain Vent Valve

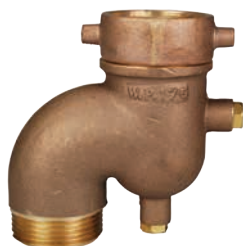

**Features:**

- attaches to the hose end of a hose rack nipple keeping the hose free of moisture by draining water from a leaky valve; when the valve is opened for use a spring valve closes the drain and directs all water through the hose
- other threads and finishes are available, consult Dixon® for more information

Female NST (NH)	Male NST (NH)	Working Pressure (PSI)	Cast Brass Part #
1½"	1½"	<b>175</b>	<b>ADV150F</b>

## Piston Intake Relief Valves

**Features:**

- standard with a 30° elbow (permitting smoother water flow), adjustable relief valve, retractable knob on hand wheel and air bleed off
- permits safe controlled flow to the intake pump and can also be used to draft
- 9 easy turns open and close the valve
- **280 PSI at 70°F (21°C)**, without relief valve
- 4½" minimum waterway
- finish anodized throughout - minimum thickness 0.001"
- relief valve - double spring, cartridge type, adjustable from **50 to 200 PSI**

### Storz x Female Swivel

Storz	Female Swivel NST (NH)	Length	Width	Height	Aluminum Alloy, 356-T6 Part #
4"	4"	12"	8"	17"	<b>FSGR440F</b>
	4½"	12"	8"	17"	<b>FSGR445F</b>
	5"	12"	8"	17"	<b>FSGR450F</b>
	6"	12"	8"	17"	<b>FSGR460F</b>
5"	4"	12"	8"	17"	<b>FSGR540F</b>
	5"	12"	8"	17"	<b>FSGR550F</b>
	6"	12"	8"	17"	<b>FSGR560F</b>



### Female Swivel x Male

Male NST (NH)	(2)Female NST (NH) Swivel	Length	Width	Height	Aluminum Alloy, 356-T6 Part #
4"	4"	12"	8"	17"	<b>FMGR40F40F</b>
	4½"	12"	8"	17"	<b>FMGR40F45F</b>
	5"	12"	8"	17"	<b>FMGR40F50F</b>
	6"	12"	8"	17"	<b>FMGR40F60F</b>
4½"	4"	12"	8"	17"	<b>FMGR45F40F</b>
	4½"	12"	8"	17"	<b>FMGR45F45F</b>
	5"	12"	8"	17"	<b>FMGR45F50F</b>
	6"	12"	8"	17"	<b>FMGR45F60F</b>
5"	4"	12"	8"	17"	<b>FMGR50F40F</b>
	4½"	12"	8"	17"	<b>FMGR50F45F</b>
	5"	12"	8"	17"	<b>FMGR50F50F</b>
	6"	12"	8"	17"	<b>FMGR50F60F</b>
6"	6"	12"	8"	17"	<b>FMGR60F60F</b>



### Replacement Parts

Description	Part #
handwheel and knob	<b>PV-HDWHL</b>
knob only	<b>PV-KNOB</b>



PV-HDWHL

## Butterfly Valves

### Storz x Female Swivel

**Features:**

- permits safe controlled flow to the intake pump, can be used for draft situations
- pressure range: **150-300 PSI** working pressure at **70°F (21°C)**
- water way: 4½", 5", and 6" maximum
- materials: body-ASTN A-126 cast iron, wafer-lightweight aluminum cast 356-T6, , seat - Buna
- ¾" push-pull drain valve
- standard 10-position locking style lever
- finish anodized cast aluminum bolt flanges - minimum thickness 0.001"
- lever handle to center valve is 10¼"
- can be used in either direction (e.g. inlet/outlet)



Storz	Female NST (NH) Swivel	Length	Width	Height	Working Pressure (PSI)	ASTN A-126 Cast Iron Part #
4"	4"	9½"	11"	18"	<b>185</b>	<b>SFBTFLY4040F</b>
	4½"	9½"	11"	18"	<b>185</b>	<b>SFBTFLY4045F</b>
	5"	9½"	11"	18"	<b>185</b>	<b>SFBTFLY4050F</b>
	6"	9½"	11"	18"	<b>185</b>	<b>SFBTFLY4060F</b>
5"	4"	9½"	11"	18"	<b>185</b>	<b>SFBTFLY5040F</b>
	4½"	9½"	11"	18"	<b>185</b>	<b>SFBTFLY5045F</b>
	5"	9½"	11"	18"	<b>185</b>	<b>SFBTFLY5050F</b>
	6"	9½"	11"	18"	<b>185</b>	<b>SFBTFLY5060F</b>
6"	6"	9½"	13"	18"	<b>185</b>	<b>SFBTFLY6060F</b>

### L/H - Male x Female Swivel

**Features:**

- permits safe controlled flow to the intake pump, can be used for draft situations
- standard 10 position lever handle
- ¾" push-pull drain valve standard
- pressure range: **150-300 PSI** at **70°F (21°C)**
- water way: 4½", 5", and 6" maximum
- seat: Buna
- finish: anodized cast aluminum bolt flanges (minimum thickness 0.001")
- lever handle to center valve is 10¼", unit can be used in either direction e.g. inlet/outlet



Male NST (NH)	Female NST (NH) Swivel	Length	Width	Height	Working Pressure (PSI)	ASTN A-126 Cast Iron Part #
4"	4"	9½"	11"	18"	<b>200</b>	<b>FMBTFLY40F40F</b>
4"	4½"	9½"	11"	18"	<b>200</b>	<b>FMBTFLY40F45F</b>
4"	6"	9½"	11"	18"	<b>185</b>	<b>FMBTFLY40F60F</b>
4½"	4½"	9½"	11"	18"	<b>185</b>	<b>FMBTFLY45F45F</b>
5"	4½"	9½"	11"	18"	<b>185</b>	<b>FMBTFLY50F45F</b>
5"	5"	9½"	11"	18"	<b>185</b>	<b>FMBTFLY50F50F</b>
5"	6"	9½"	11"	18"	<b>185</b>	<b>FMBTFLY50F60F</b>
6"	6"	9½"	13"	18"	<b>185</b>	<b>FMBTFLY60F60F</b>

Specialty Products

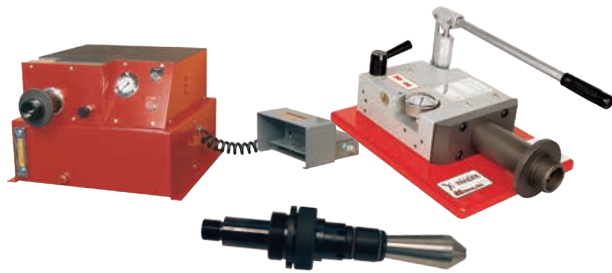

Fire Hose Coupling Machines and Accessories



Low Level Strainer - Floating Strainer



Dry Hydrants



Barrel and Basket Strainers



Booster Hose Installation Kit



Piston Intake Valve



Suction Hoses

Partial Listing of Powder Coating Colors Available for Wrenches

Contact Dixon Fire at 877.712.6179 for more information.

Black	Dark Blue	Medium Blue	Gray	Red	Orange

Mustard	Yellow	Green	Aqua	Plum	Pink

**Petroleum Fuel Nozzles ..... 845 to 853**

Ball..... 845  
 Gravity utility ..... 846  
 Pressure ..... 846  
 Overwing aircraft ..... 847  
 Large capacity low pressure / gravity ..... 847  
 Hose shank hose swivels ..... 848  
 Heavy duty hose swivels ..... 848  
 MannTek hose swivels..... 848  
 Dixon® diesel and gasoline nozzle accessories ..... 849  
     Single plane hose swivels..... 849  
     Multi plane hose swivels ..... 849  
     Breakaways ..... 849  
 FuelMaster™ diesel ..... 850  
 Big Mouth™ diesel ..... 851  
 Farm and consumer ..... 852  
 DEF automatic shutoff ..... 853  
 High flow fueler 100™ ..... 853

**Fire Nozzles ..... 854 to 857**

Fog ..... 854  
 Industrial fog ..... 854  
 Heavy duty industrial fog ..... 855  
 High pressure industrial fog..... 855  
 Electrical all-fog ..... 855, 856  
 Factory mutual approved..... 856  
 Gaskets ..... 856  
 Plain hose..... 857  
 Industrial washdown ..... 857

**Washdown Nozzles ..... 857 to 864**

Swivel connectors for washdown spray guns..... 857  
     Ball type swivel x hose shank ..... 857  
     Straight swivel x hose shank..... 857  
     Straight swivel x GHT thread ..... 857  
 Hot water washdown spray ..... 858  
 Lite washdown spray ..... 858  
 Mini spray ..... 859  
 Spray ..... 859  
 Washdown wand ..... 859  
 Temperature indicating spray ..... 860  
 Stainless steel industrial grade spray ..... 860  
 Brass industrial grade front lever spray ..... 860  
 Thermal-Gard™ elevated temperature spray..... 861  
 Spray valve and hose assembly..... 861  
 Sweeper ..... 862  
 Water ..... 862  
     Flexible..... 862  
     Brass / rubber power flow ..... 862  
     Insulated ..... 862

**Washdown Nozzles (cont.). 857 to 864**

Pistol-grip ..... 862  
 Twist ..... 862  
 Adjust-A-Power..... 863  
 Constant flow nozzle displays ..... 863  
 Constant flow nozzle with bumper..... 863

**Washdown / Mixing Stations..... 864**

Water-steam washdown station ..... 864  
 Hot and cold water mixing station..... 864  
 Rack for mixing station ..... 864

**Pressure Washing ..... 865 to 872**

Spray guns ..... 865  
     Anti-fatigue..... 865  
     Pressure..... 865  
     Heavy duty anti-fatigue ..... 865  
     Pressure with extension..... 865  
     Pressure with hose, nozzle & lance ..... 865  
 Spray lances and extensions for pressure gun ..... 866  
     Spray lances ..... 866  
     Dual spray lances ..... 866  
     Molded grip extensions ..... 866  
     Vented grip lances ..... 866  
 Telescoping lance and belt for pressure gun ..... 867  
 Swiveling quick couplings..... 867  
 Fixed plugs ..... 868  
 Injector nozzles..... 868  
 Line strainer..... 868  
 High pressure spray soap nozzles ..... 869  
 High pressure spray nozzles ..... 869  
 Quick connect soap nozzle..... 869  
 Quick connect spray nozzle..... 869  
 Multi-pack quick connect nozzles ..... 869  
 Multi-pack high pressure spray nozzles ..... 869  
 Spray nozzle selection guidelines ..... 870  
 Turbo nozzles ..... 871  
 Nozzle holders..... 871  
 Inlet filter for turbo nozzles ..... 871  
 Balance release valve ..... 871  
 Water broom..... 871  
 Unloader valves..... 872  
 Thermal relief valve ..... 872  
 Safety release valve ..... 872

## Ball Nozzles for Bulk Delivery

**Features:**

- rugged construction, high flow provides rapid fuel oil transfer/delivery
- heavy duty roller ball swivel with low temperature seals freely rotates without leaking at **-40°F (-40°C)** and **100 PSI**
- 3 PSI check valve is included to prevent back flow, 5 PSI is optional

**nozzles**

Female NPT Inlet	Outlet Type	Anodized Aluminum Part #
1¼"	swivel quick fill nut	<b>BL062</b>
1½"	swivel quick fill nut	<b>BL064</b>
1¼"	1¼" spout	<b>BL066</b>
1½"	1¼" spout	<b>BL068</b>
1½"	1½" spout	<b>BL072</b>
1¼"	1¼" female NPT	<b>BL066NS</b>
1½"	1¼" female NPT	<b>BL068NS</b>
1½"	1½" female NPT	<b>BL072NS</b>
2"	2" spout	<b>BL920</b>



BL062

**replacement spouts**

Size	Replacement For	Aluminum Part #
1¼"	<b>BL066, BL068</b>	<b>1143A</b>
1½"	<b>BL072, BL919</b>	<b>1125A</b>
2"	<b>BL920</b>	<b>391137</b>



BL072

**repair kits**

**Repair Kits for Ball Nozzles (BL066, BL068, BL072, BL919)**

Description	Part #
inlet swivel seal and wear kit	<b>SWMF-RK2</b>
complete inlet swivel rebuild kit	<b>SWMF-RK3</b>
1½" FNPT replacement inlet swivel	<b>SWMF-RK4</b>
1¼" FNPT replacement inlet swivel	<b>SWMF-RK5</b>
1½" BSPP replacement inlet swivel	<b>SWMF-RK6</b>
replacement swivel outlet (BL062, BL064)	<b>BL005</b>
ball valve shaft seal kit	<b>BL-RK4</b>
complete ball nozzle seal kit	<b>BL-RK10</b>
optional check valve 5 PSI spring kit	<b>BL-RK11</b>
standard check valve 3 PSI cartridge kit	<b>BL-RK12</b>



BL072NS

**Repair Kits for Super Ball Nozzle (BL920)**

inlet swivel grease nipple kit (optional)	<b>SWMF-RK1</b>
inlet swivel seal and wear kit	<b>SWMF-RK22</b>
complete inlet swivel rebuild kit	<b>SWMF-RK32</b>
2" FNPT replacement inlet swivel	<b>SWMF-RK42</b>
1½" FNPT replacement inlet swivel	<b>SWMF-RK52</b>
complete ball nozzle seal kit	<b>BL-RK102</b>
optional check valve 5 PSI spring kit	<b>BL-RK112</b>
standard check valve 3 PSI cartridge kit	<b>BL-RK122</b>
replacement trigger kit	<b>BL-RK13</b>



BL920





## Gravity Utility Nozzles

**Application:**

- for use with 12 volt pumps and gravity flow fittings in economy fuel dispensing applications

**Features:**

- manual operation (non-automatic)
- Underwriters Listed
- working pressure: **25 PSI**

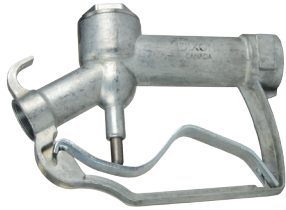

900



900W34S



900B

Female NPT Inlet	Outlet Type	Die Cast Zinc Aluminum Part #
1"	1" female UNS	<b>900<sup>1</sup></b>
	1" straight spout	<b>900S</b>
	1" bent spout	<b>900B</b>
	¾" straight spout	<b>900W34S</b>
	¾" bent spout	<b>900W34B</b>
¾"	¾" straight spout	<b>900S34<sup>2</sup></b>
	¾" bent spout	<b>900B34<sup>2</sup></b>

<sup>1</sup> nozzle body only (no spout)

<sup>2</sup> ¾" nozzle inlet uses 1" x ¾" reducer bushing, supplied

### replacement parts

Description	Part #
¾" replacement straight spout	<b>234-80-4</b>
¾" replacement bent spout	<b>234-80-5</b>
1" replacement straight spout	<b>875-4</b>
1" replacement bent spout	<b>875-5</b>
trigger	<b>900TK</b>
plunger and valve assemblies, cap, O-ring	<b>900SK</b>

## Pressure Nozzle for Bulk Delivery

**Features:**

- manual operation (non-automatic) for high pressures and fuel flow up to **100 GPM**
- easy opening dash pot design with shockless closing
- detachable trigger ratchet, packing gland and seal
- bronze trigger



114DNS

Female NPT Inlet	Outlet Type	GPM @ 10 PSI	Aluminum Part #
1¼"	1¼" female NPT	80	<b>114DNS</b>
	1¼" spout	80	<b>114D</b>
1½"	1½" female NPT	100	<b>112DNS</b>
	1½" spout	100	<b>112D</b>

### replacement parts

Description	Part #
aluminum replacement spout for 114D	<b>1143A</b>
aluminum replacement spout for 112D	<b>1125A</b>
main poppet, 2nd poppet, cap O-ring, valve stem	<b>112DSK</b>
blank plate to replace ratchet plate if ratchet not required	<b>114DAL-AV-19</b>
main and secondary poppets, cap O-ring, valve stem assembly and packing, sleeve stem packing and nut	<b>114DSK</b>



114D



Overwing Aircraft Nozzles

**Features:**

- manual operation (non-automatic) for high pressures and fuel flow up to **60 GPM at 20 PSI**
- easy opening dash pot design with shock-less closing
- detachable trigger ratchet, packing gland and seal
- bronze trigger and plastic guard pad to protect wing
- spout comes with cap, spring cord, fine mesh stainless steel screen filter and screw attachment for grounding cable (cable not supplied)

Female NPT Inlet	Outlet Type	Aluminum Part #
1¼"	1" spout	<b>114DAVR</b>
	1¼" spout	<b>114D-AV</b>
1½"	1¼" spout	<b>114D-AV-06ASM</b>



114D-AV-06ASM

**replacement parts**

Description	Part #
trigger, bushing, pin and cotter pin	<b>114/2D-TK</b>
main & secondary poppet assemblies, cap	<b>114DAV-SK</b>
O-ring, valve stem assembly	<b>114DAL-AV-25</b>
1" spout assembly	<b>114DAL-AV-16</b>
1¼" spout assembly	<b>114DAL-AV-16</b>

Large Capacity Low Pressure / Gravity Nozzle

**Application:**

- for low pressure/gravity applications

**Features:**

- rapid flow due to 1¼" oversize design
- maximum operating pressure: **25 PSI**

Female NPT Inlet	Outlet Type	Aluminum Part #
1¼"	1¼" spout	<b>1250-94</b>



**repair kits**

Description	Part #
plunger, O-rings, valve seal, valve base, valve plate	<b>1250SK</b>



### Hose Shank Hose Swivels

**Application:**

- for use with petroleum and home heating oil hose

**Feature:**

- prevents hose twisting or kinking



Male NPT	Shank Size	Bronze Part #
1½"	1½"	<b>1565U</b>
<b>repair kit</b>		
Description		Part #
replacement seal kit and retaining ring		<b>1500SK</b>

### Heavy Duty Hose Swivels

**Features:**

- male NPT x female NPT threaded connections
- heavy duty internal thrust bearing and anti-friction seal design ensures swiveling at **-40°F (-40°C)**
- can be lubricated without disassembly by using the optional grease nipple kit below



Male NPT	Female NPT	Bayloy Part #
1¼"	1¼"	<b>SWMF125</b>
1½"	1½"	<b>SWMF150</b>
2"	2"	<b>SWMF200</b>
<b>repair kits</b>		
Description		Part #
inlet swivel grease nipple kit (optional)		<b>SWMF-RK1</b>
inlet swivel seal and wear kit		<b>SWMF-RK22</b>
complete inlet swivel rebuild kit		<b>SWMF-RK32</b>
2" FNPT replacement inlet swivel		<b>SWMF-RK42</b>
1½" FNPT replacement inlet swivel		<b>SWMF-RK52</b>

### MannTek Hose Swivels

**Features:**

- allows the hose to relax to it's natural rest position while allowing freedom of movement without adding torque stress at the point of connection
- simple design, low maintenance - consists of 2 body halves, ball bearings and a washer
- male NPT x female NPT threaded connections
- FKM seals standard, Chemraz® and Kalrez® optional contact Dixon®
- working pressure: **150 PSI**
- maximum temperature: **300°F (149°C)**



Size	316 Stainless Steel	Aluminum
	Part #	Part #
¾"	<b>HS075SS</b>	<b>HS075AL</b>
1"	<b>HS100SS</b>	<b>HS100AL</b>
1½"	<b>HS150SS</b>	<b>HS150AL</b>
2"	<b>HS200SS</b>	<b>HS200AL</b>
3"	<b>HS300SS</b>	<b>HS300AL</b>
4"	<b>HS400SS</b>	<b>HS400AL</b>

Dixon® Diesel and Gasoline Nozzles Accessories

Single Plane Hose Swivels

Materials:

- body: aluminum
- brass hex nut prevents galling in the nozzle
- seals: F-7036 Viton™
- retainer: nylon cord

Size	Part #
¾" x ¾"	<b>DAWS34</b>
1" x 1"	<b>DAWS10</b>



Multi-Plane Hose Swivels

Features:

- brass male end will not gall in nozzle castings
- dual O-rings seal with all fuels
- sleeve gives smooth seal surface - no leaks
- internal nylon retainer cord secures firmly but allows free rotation

Materials:

- body: machined aluminum casting
- male end: machined brass bar stock
- sleeve: machined brass bar stock

Size	Part #
¾" male NPT x ¾" female NPT	<b>DAC3434</b>
1" male NPT x ¾" female NPT	<b>DAC1034</b>



Breakaways

Features:

- unique ball valves seal both ends when separated
- design provides consistent and reliable performance
- lightweight
- easy to repair
- ¾" Underwriter's Listed

Materials:

- body: aluminum
- break rings (2): brass
- seals: F-7036 Viton™

Size	Separation Force (Lbs)	Part #
¾"	325	<b>DAB34</b>
1"	325	<b>DAB1</b>



Breakaways

Applications:

- Provides breakaway protection for high capacity fueling operations such as truck and bus terminals, mining, off-road fueling and fuel oil delivery.

Materials:

- body: nickel plated aluminum
- brass break rings: 4 total in 1¼" and 1½"; 6 total in 2"
- seals: F-7036 Viton™
- check valve - PTFE ball seals both ends when separated

Size	Separation Force in Lbs.	Part #
1¼"	600	<b>DAB14</b>
1½"	600	<b>DAB15</b>
2"	800	<b>DAB2</b>



## FuelMaster™ Diesel Nozzles

**Application:**

- truck stops and terminal operations (not designed for use with gravity flow tanks, small 12 volt or AC utility pumps, farm or consumer pumps) 

**Features:**

- high flow capacity
- Micro-touch valve provides smooth operation and exceptional flow control
- Roto-matic latch pin provides positive auto shut-off
- pure PTFE packing eliminates stem leaks
- easy to change 'locknut style' spout assembly
- green scuff guard

**Optional Features:**

- Underwriters Listed versions 
- UL listed for use with Gas 10% Ethanol blend and diesel
- super tough nylon trigger hold-open clip
- 'no pressure, no flow' (NPNF) safety valve prevents the trigger from being held open if pressure is not present

**Materials:**

- body and spout: aluminum
- body caps: zinc
- seals: FKM
- poppet disk: FKM
- stem packing: PTFE
- hand-guard and trigger hold open clip: super tough nylon
- trigger: steel
- snap-on cover: plastic
- scuff guard: vinyl

**Features:**

- with trigger hold-open clip
- non Underwriters Listed nozzle

NPT Inlet	Spout Outlet	Approximate Flow Rate at 20 PSI (GPM)	Part #
1"	1-3/16"	35	<b>DFN100HF</b>
	1-3/16"	45	<b>DFN100SF</b>



DFN100HF

**Features:**

- with trigger hold-open clip
- with 'no pressure, no flow' safety valve
- Underwriters Listed nozzle 

NPT Inlet	Spout Outlet	Approximate Flow Rate at 20 PSI (GPM)	Part #
1"	1-3/16"	35	<b>DFN100HF-NPNF</b>
	1-3/16"	45	<b>DFN100SF-NPNF</b>

**Features:**

- without trigger hold-open clip
- Underwriters Listed nozzle 

NPT Inlet	Spout Outlet	Approximate Flow Rate at 20 PSI (GPM)	Part #
1"	1-3/16"	35	<b>DFN100HF-NC</b>
	1-3/16"	45	<b>DFN100SF-NC</b>



DFN100SF

## Big Mouth™ Diesel Nozzles

### Application:

- truck stops (not designed for use with gravity flow tanks, small 12 volt or AC utility pumps, farm or consumer pumps)



### Features:

- lightweight but strong
- Micro-touch valve provides smooth operation and exceptional flow control
- Roto-matic latch pin provides positive auto shut-off
- pure PTFE packing eliminates stem leaks
- super tough nylon hand guard
- snap-on handle cover makes changing scuff guards easy
- yellow scuff guard

### Optional Features:

- Underwriters Listed versions 
- UL listed for use with gas 10% Ethanol blend and diesel
- super tough nylon trigger hold-open clip
- 'no pressure, no flow' (NPNF) safety valve prevents the trigger from being held open if pressure is not present

### Materials:

- body and spout: aluminum
- body caps: zinc
- seals: FKM / nitrile
- poppet disk: FKM
- stem packing: PTFE
- trigger: steel
- snap-on cover: plastic
- scuff guard: vinyl

### Features:

- with trigger hold-open clip
- non Underwriters Listed nozzle

NPT Inlet	Spout Outlet	Approximate Flow Rate at 20 PSI (GPM)	Part #
1"	1 1/8"	27	<b>DFN100</b>

### Features:

- with trigger hold-open clip with 'no pressure, no flow' safety valve
- Underwriters Listed nozzle 

NPT Inlet	Spout Outlet	Approximate Flow Rate at 20 PSI (GPM)	Part #
1"	1 1/8"	27	<b>DFN100-NPNF</b>

### Features:

- without trigger hold-open clip
- Underwriters Listed nozzle 

NPT Inlet	Spout Outlet	Approximate Flow Rate at 20 PSI (GPM)	Part #
1"	1 1/8"	27	<b>DFN100-NC</b>



DFN100



DFN100-NC

Farm and Consumer Nozzles

**Application:**

- small 12 volt or AC utility pumps, farm or consumer pumps (not designed for use with gravity flow tanks)



**Features:**

- Micro-touch valve provides smooth operation and exceptional flow control
- pure PTFE stem packing eliminates leaks
- heavy duty, strong, secure hook makes it easy to hang the nozzle on the pump
- Roto-matic latch pin provides positive auto shut-off
- Smartguard snap-on scuff guard

**Optional Features:**

- Underwriters Listed versions 
- super tough nylon trigger hold-open clip
- 'no pressure, no flow' (NPNF) safety valve prevents the trigger from being held open if pressure is not present

**Materials:**

- body and spout: aluminum
- body caps: zinc or nylon
- seals: FKM
- poppet disk: FKM
- stem packing: PTFE
- hand-guard and trigger hold open clip: super tough nylon
- trigger: steel
- snap-on cover: plastic
- scuff guard: vinyl

**Features:**

- with trigger hold-open clip
- non Underwriters Listed nozzle



1" diesel nozzle

NPT Inlet	Spout Outlet	Approximate Flow Rate at 20 PSI (GPM)	Scuff Guard Color	Service	Part #
3/4"	13/16"	<b>18</b>	black	gasoline	<b>DN7UOBF</b>
	15/16"	<b>23</b>	green	diesel	<b>DN7LOBF</b>
1"	1-1/8"	<b>27</b>	yellow	diesel	<b>DFN100F<sup>1</sup></b>

<sup>1</sup> Hand-guard and rear back clip: super tough nylon

**Features:**

- with trigger hold-open clip
- with 'no pressure, no flow' safety valve
- Underwriters Listed nozzle 



3/4" gasoline nozzle

NPT Inlet	Spout Outlet	Approximate Flow Rate at 20 PSI (GPM)	Scuff Guard Color	Service	Part #
3/4"	13/16"	<b>18</b>	black	gasoline	<b>DN7UOBF-NPNF</b>
	15/16"	<b>23</b>	green	diesel	<b>DN7LOBF-NPNF</b>
1"	1-1/8"	<b>27</b>	yellow	diesel	<b>DFN100F-NPNF</b>

**Features:**

- without trigger hold-open clip
- Underwriters Listed nozzle 



3/4" diesel nozzle

NPT Inlet	Spout Outlet	Approximate Flow Rate at 20 PSI (GPM)	Scuff Guard Color	Service	Part #
3/4"	13/16"	<b>18</b>	black	gasoline	<b>DN7UOBF-NC</b>
	15/16"	<b>23</b>	green	diesel	<b>DN7LOBF-NC</b>
1"	1-1/8"	<b>27</b>	yellow	diesel	<b>DFN100F-NC</b>

**Fuel Nozzle Part Number Cross Reference**

Dixon™	M. Carder	OPW	Emco	Husky	Catlow
DN7UOBF	N7UOBF	1AF-40FS	A2501F	XSF-33704	NENLF
DN7LOBF	N7LOBF	11APF-40FS	A2501LF	---	NELF

### DEF Automatic Shutoff Nozzle

**Application:**

- designed for diesel exhaust fluid applications

**Feature:**

- maximum operating pressure: **50 PSI**

**Materials:**

- aluminum body double coated inside and out with PTFE baked on at **500°F (260°C)**
- spout: stainless steel
- wetted parts: stainless, acetal, PTFE
- seal: FKM-A



BSPB Inlet	Spout Outlet	Approximate Flow Rate at 20 PSI (GPM)	Part #
3/4"	13/16"	<b>18</b>	<b>DEFN075</b>

### High Flow Fueler 100™ Nozzles

**Application:**

- for fueling trucks, buses, off-road equipment and fuel oil delivery
- *These nozzles are not to be used with gravity flow tanks.*



**Features:**

- machined grooves in the spout are designed to hold nozzle more securely in the fill pipe
- high flow, heavy duty automatic nozzle



NPT Inlet	Spout Outlet	Approximate Flow Rate at 30 PSI (GPM)	Part #
1 1/4"	1 3/8"	<b>75</b>	<b>DNOG5-NL<sup>1</sup></b>
1 1/4"	1 3/8"	<b>75</b>	<b>DNOG5</b>
1 1/2"	1 3/8"	<b>75</b>	<b>DNOG6</b>

<sup>1</sup> is a 1 1/4" nozzle without the locking handle





## Industrial Fog Nozzles

**Features:**

- maximum operating pressure: **175 PSI** (water only) at **70°F (21°C)**
- delivers 30° - 60° - 90° fog pattern - shut-off - straight stream - fog
- UL listed and Factory Mutual approved for class A and B fires (except noted <sup>1 2</sup>)
- new UL and FM approvals are pending due to change in standard UL401 products are to be reapproved, data subject to change in coming months supplied with bumper



Size	Thread	90° Spray GPM @ 100 PSI	Wide Open GPM @ 100 PSI	Brass Part #
3/4"	GHT	---	---	<b>BFN75GHT</b> <sup>1</sup>
3/4"	NPSH	---	---	<b>BFN75</b>
1"	NPSH	32	---	<b>BFN100</b>
1 1/2"	NPSH	---	100	<b>BFN150</b>
2"	NPSH	108	---	<b>BFN200</b> <sup>1 2</sup>
1"	NST (NH)	32	---	<b>BFN100NST</b>
1 1/2"	NST (NH)	---	100	<b>BFN150NST</b>
2 1/2"	NST (NH)	205	---	<b>BFN250NST</b> <sup>1 2</sup>

<sup>1</sup> not UL Listed

<sup>2</sup> not Factory Mutual approved

• replacement washers can be found on page 741



## Heavy Duty Industrial Fog Nozzles

**Features:**

- maximum operating pressure: **175 PSI** (water only) at **70°F (21°C)**
- delivers 30° - 60° - 90° fog pattern - shut-off - straight stream - fog
- New UL and FM approvals are pending due to change in standard UL 401
- Products are to be reapproved, data subject to change in coming months
- UL listed and Factory Mutual approved
- supplied with bumper



Size	Thread	90° Spray GPM @ 100 PSI	Brass Part #
1"	NPSH	---	<b>HFN100</b>
1 1/2"	NPSH	<b>88 (+/-12)</b>	<b>HFN150</b>
1"	NST (NH)	---	<b>HFN100NST</b>
1 1/2"	NST (NH)	<b>88 (+/-12)</b>	<b>HFN150NST</b>
1 1/2"	NYFD	---	<b>HFN150NYFD</b>

• replacement washers can be found on page 741



## High Pressure Industrial Fog Nozzles

**Features:**

- working pressure: **25 to 300 PSI** (water only) at **70°F (21°C)**
- combination straight stream and fog - shut-off - straight stream - fog
- Factory Mutual approved
- large one-piece rubber bumper with molded teeth
- knurled base



Size	Thread	90° Spray GPM @ 100 PSI	Brass Part #
1 1/2"	NPSH	<b>117</b>	<b>HPFN150</b>
	NST (NH)	<b>117</b>	<b>HPFN150NST</b>

• replacement washers can be found on page 741



Electrical Fire All-Fog Nozzles



Features:

- maximum operating pressure: **100 PSI** (water only) at **70°F (21°C)**
- delivers 30° - 60° - 90° fog pattern - shutoff to 30° fog, adjustable to 90° fog
- New UL and FM approvals are pending due to change in standard UL 401
- Products are to be reapproved, data subject to change in coming months
- UL listed and Factory Mutual approved for class C fires
- supplied with bumper
- Use of this nozzle is not likely to prove hazardous when nozzle is held in excess of 10 feet from electrical apparatus and circuits not involving more than 250,000 volts.



Size	Thread	Wide Open GPM @ 100 PSI	Brass Part #
1½"	NST (NH)	96	<b>BFNE150NST</b>
	NPSH	96	<b>BFNE150</b>

- for fog nozzle flow rates please see next page
- replacement washers can be found on page 741

Fog Nozzles

Features:

- shutoff - straight stream - fog
- maximum operating pressure: **100 PSI** (water only) at **70°F (21°C)**
- brass stem

Size	Thread	90° Spray GPM @ 100 PSI	Polycarbonate <sup>1</sup> Part #	Polycarbonate <sup>2</sup> Part #
¾"	GHT	<b>8.0</b>	<b>FNB75GHT</b> <sup>3,4</sup>	---
¾"	NPS	<b>30.9</b>	<b>FNB75S</b> <sup>4</sup>	---
1"	NPS	<b>11.4</b>	<b>FNB100S</b> <sup>4</sup>	<b>FN100S</b>
1"	NPS	<b>30.9</b>	<b>HGB100S</b>	---
1½"	NPS	<b>83.6</b>	<b>FNB150S</b>	<b>FN150S</b>
1"	NST (NH)	<b>11.4</b>	<b>FNB100NST</b>	<b>FN100NST</b>
1"	NST (NH)	<b>30.9</b>	<b>HGB100NST</b>	---
1½"	NST (NH)	<b>83.6</b>	<b>FNB150NST</b>	<b>FN150NST</b>



with bumper



without bumper

- <sup>1</sup> with bumper
- <sup>2</sup> without bumper
- <sup>3</sup> standard flow
- <sup>4</sup> 120° spray GPM @100 PSI
- replacement washers can be found on page 856

Fog Nozzle Flow Rate Chart

Part Number	Inlet Pressure		Straight Stream		30°		60°		90°	
	PSI	kPa	GPM	LPM	GPM	LPM	GPM	LPM	GPM	LPM
<b>BFN100</b>	<b>50</b>	(345)	18	(68)	21	(79)	24	(91)	27	(102)
	<b>75</b>	(517)	22	(83)	25	(95)	28	(106)	32	(121)
	<b>100</b>	(690)	24	(91)	28	(106)	32	(121)	36	(136)
<b>BFN250</b>	<b>50</b>	(345)	90	(341)	120	(454)	130	(492)	145	(549)
	<b>75</b>	(517)	100	(379)	140	(530)	150	(568)	180	(681)
	<b>100</b>	(690)	110	(416)	165	(625)	180	(681)	205	(776)
<b>HFN100</b>	<b>100</b>	(690)	25	(95)	---	---	---	---	---	---
<b>HFN150</b>	<b>100</b>	(690)	---	---	---	---	---	---	86	(326)
<b>HPFN150</b>	<b>275</b>	(1040)	---	---	---	---	---	---	130	(492)

- fire fog nozzles are listed above and on previous pages



## Factory Mutual Approved Fog Nozzles

**Features:**

- brass stem with locking nut
- shutoff-straight-stream-fog
- wings on sleeve for ease of adjustment
- maximum operating pressure: **100 PSI** (water only) at **70°F (21°C)**
- Factory Mutual approved



with bumper



without bumper

Size	Thread	90° Spray GPM @ 100 PSI	Polycarbonate <sup>1</sup> Part #	Polycarbonate <sup>2</sup> Global Part #
3/4"	GHT	<b>30.9</b>	<b>SL075GHT<sup>3</sup></b>	---
3/4"	NPSH	<b>30.9</b>	<b>SL075<sup>3</sup></b>	---
1"	NPSH	<b>30.9</b>	<b>SL100<sup>3</sup></b>	<b>PFNB100S</b>
1 1/2"	NPSH	<b>75.0</b>	<b>SL150</b>	<b>PFNB150S</b>
1"	NST (NH)	<b>30.9</b>	<b>SL100NST</b>	---
1 1/2"	NST (NH)	<b>75.0</b>	<b>SL150NST</b>	<b>PFNB150NST</b>

- <sup>1</sup> with bumper
- <sup>2</sup> without bumper
- <sup>3</sup> 120° spray on 3/4" and 1"

## Polycarbonate Electrical Fire All-Fog Nozzles

**Features:**

- opens and closes in a 30° fog pattern up to 120°- no straight stream
- maximum operating pressure: **100 PSI** (water only) at **70°F (21°C)**
- brass stem



Size	Thread	75° Spray GPM @ 100 PSI	Polycarbonate Part #
1 1/2"	NPS	<b>92</b>	<b>FNBE150S</b>
	NST (NH)	<b>92</b>	<b>FNBE150NST</b>

## Gaskets for Fog Nozzles



Size	Thread	ID	OD	Thickness	Buna-N Part #
1"	NPSH	0.937"	1.234"	0.125"	<b>FNG100S</b>
1"	NPSH	1.000"	1.375"	0.125"	<b>HGG100S</b>
1 1/2"	NPSH	1.500"	1.827"	0.125"	<b>FNG150S</b>
1"	NST (NH)	0.937"	1.281"	0.125"	<b>FNG100NST</b>
1"	NST (NH)	1.000"	1.375"	0.125"	<b>HGG100NST</b>
1 1/2"	NST (NH)	1.510"	1.906"	0.125"	<b>FNG150NST</b>

- dimensions are nominal

Plain Hose Nozzles

Features:

- finish: satin
- maximum operating pressure: **100 PSI** (water only) at **70°F (21°C)**

Size	Thread	Overall Length	Orifice	Replacement Gasket	Brass	
					Previous Part #	Part #
3/4"	GHT	6"	1/4"	<b>KRW5</b>	500SN6	<b>BN6</b>
3/4"	NPSH	6"	1/4"	<b>KRW5</b>	---	<b>BN7</b>
1"	NPSH	8"	5/16"	<b>KRW10</b>	---	<b>BN10</b>
1 1/4"	NPSH	10"	3/8"	<b>KRW15</b>	---	<b>BN12</b>
1 1/2"	NPSH	10"	1/2"	<b>KRW20</b>	---	<b>BN15</b>
2"	NPSH	12"	9/16"	<b>SW200</b>	---	<b>BN20</b>
2 1/2"	NPSH	12"	1"	<b>KRW35</b>	---	<b>BN25</b>
1"	NST (NH)	8"	5/16"	<b>SW100F</b>	---	<b>BN10F</b>
1 1/2"	NST (NH)	10"	1/2"	<b>SW150</b>	---	<b>BN15F</b>
2 1/2"	NST (NH)	12"	1"	<b>SW250</b>	---	<b>BN25F</b>
1 1/2"	NYFD	10"	1/2"	<b>SW150</b>	---	<b>BN15NYFD</b>
2 1/2"	NYFD	12"	1"	<b>SW250</b>	---	<b>BN25NYFD</b>



Industrial Washdown Nozzles

Features:

- maximum operating pressure: **100 PSI** (water only) at **70°F (21°C)**
- delivers 30° - 60° - 90° fog pattern
- shut off - straight stream - fog
- supplied with bumper

Size	Thread	90° Spray GPM @ 100 PSI	Brass Part #
1 1/2"	NPSH	88 (+/-12)	<b>WDN150</b>
	NST (NH)	88 (+/-12)	<b>WDN150NST</b>



Swivel Connectors for Washdown Spray Guns

Ball Type Swivel x Hose Shank

Features:

- swivel connector for stainless spray nozzles
- 360° ball type swivel adapter helps prevent hose kinking

NPT	Hose ID	Brass Part #	300 Stainless Steel Part #
1/2"	1/2"	---	<b>SSA44</b>
	5/8"	---	<b>SSA54</b>
	3/4"	---	<b>SSA64</b>
3/8"	1/2"	<b>BSA34</b>	---

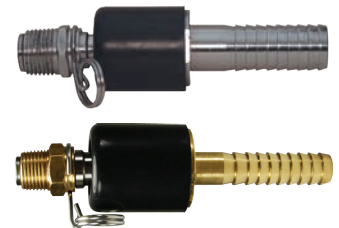

Straight Swivel x Hose Shank

Features:

- swivel body
- gasket: EPDM

NPT	Hose ID	Brass Part #	Stainless Steel Part #
1/2"	1/2"	<b>BNS44</b>	<b>BNS44SS</b>
	3/4"	<b>BNS64</b>	<b>BNS64SS</b>



Straight Swivel x GHT Thread

NPT	Female GHT	Brass Part #
1/2"	3/4"	<b>BMAS974</b>



## Hot Water Washdown Spray Nozzles

**Application:**

- for low pressure cleaning, tank and drum cleaning and chemical manufacturing

**Features:**

- designed for operator comfort
- variable spray pattern from conical spray to solid stream
- hose connects at base of gun for easy maneuvering
- ½" female NPT inlet
- rubber coated handle protects hands from water temperatures to **150°F (66°C)**
- **12.5 GPM** flow capacity at **150 PSI**
- *Do not use with steam lines.* 



Cover Color	Brass Part #	Aluminum Part #
black	<b>BWSG</b>	<b>AWSG</b>
white	<b>BWSG-W</b>	<b>AWSG-W</b>



## Lite Washdown Spray Nozzles

**Application:**

- for use where reduced size and / or flow rate is preferred

**Features:**

- more compact and lighter than standard nozzle
- special formulated rubber cover for durability and easy replacement
- ¾" female NPT inlet
- **9.0 GPM** flow capacity at **100 PSI**
- pressure rating: **150 PSI**
- temperature rating **200°F (93°C)**



LWSG-W



LWSG-B

Cover Color	Brass Part #
blue	<b>LWSG-B</b>
white	<b>LWSG-W</b>

### Mini Spray Nozzle

**Features:**

- ½" female NPT inlet
- not for use with steam 
- designed as an industrial lightweight nozzle with heavyweight performance
- durable dark blue cover protects user from hot surfaces produced by high temperature wash down applications
- reduces hand fatigue and provides smooth lever action
- variable spray patterns from fan spray to solid stream
- drip-free automatic shutoff feature
- pressure rating **150 PSI at 200°F (93°C)**
- flow: **9.6 GPM at 100 PSIG**



---

*Stainless Steel*  
Part #  
**DM150SDB**

---

### Spray Nozzle

**Features:**

- ½" female NPT inlet
- designed to prevent accidental spray
- durable dark blue cover prevents front-mounted lever from being accidentally activated if nozzle is dropped
- reduces hand fatigue and provides smooth lever action
- trigger locking mechanism provides safe and secure method of keeping the nozzle open during any spray pattern
- variable spray patterns from fan spray to solid stream
- drip-free automatic shut-off feature
- can be used with **D150S-WAND**
- rated to **150 PSI at 200°F (93°C)**
- **9.6 GPM** flow capacity at **100 PSIG**





---

*Stainless Steel*  
Part #  
**D150SDB**

---

### Washdown Wand

**Features:**

- designed to provide user with a means of reaching desired washdown locations previously deemed unreachable by extending the nozzle by 3'
- adjustable spray tip can be changed from fan to solid spray by twisting the tip until the desired flow pattern is achieved
- quick disconnect feature allows user to quickly connect wand to the nozzles above
- designed to only fit the D150SDB nozzle
- minimum pressure is **75 PSI**
- wand is not for use with steam 

---

*300 Series Stainless Steel*  
Part #  
**D150S-WAND**

---



## Temperature Indicating Spray Nozzle



**Features:**

- easy to read dial thermometer at rear of the nozzle provides accurate and continual monitoring of water temperature
- plastic sight window
- gauge assembly is recessed into the rubber cover for complete protection
- alerts the operator to shut-down the steam valve upon cold water failure, preventing scalding and steam burn injuries ensuring operator safety
- ensures a more accurate discharge water temperature reading
- recommended for water temperatures to **200°F (93°C)**
- maximum operating pressure: **150 PSI**
- **12.5 GPM** flow capacity
- ½" female NPT inlet
- black cover

---

*Bronze*

Part #

---

**BWSG-TI**

## Stainless Steel Industrial Grade Spray Nozzle



**Application:**

- recommended for use in corrosive applications where bronze and aluminum nozzles are not suitable

**Features:**

- heavy duty 300 series stainless steel body and barrel
- variable spray pattern adjusts from a soft spray to a solid stream
- Replaceable rubber cover is specially formulated to resist a wide range of oils and chemicals and protect surrounding equipment.
- maximum operating pressure: **150 PSI**
- maximum flow: **12.5 GPM at 150 PSI**
- ½" female NPT inlet
- maximum temperature: **200°F (93°C)**

---

*300 Stainless Steel*

Part #

---

**300SSSG**

## Brass Industrial Grade Front Lever Spray Nozzle



**Features:**

- provides effortless one hand operation; by actuating the operating lever the valve is opened/closed and the jet power is regulated from spray to concentrated jet
- adjusting screw on back of gun allows you to fix the desired form of jet, fixing clamp for the operating lever allows lockable position for service
- maximum operating pressure: **350 PSI**
- suitable for hot water up to **122°F (50°C)**
- flow: **6.6 GPM at 72 PSI**
- ½" female NPT inlet
- durable blue rubber cover

---

*Brass*

Part #

---

**DWG050**

## Thermal-Gard™ Elevated Temperature Spray Nozzle

**Features:**

- Thermal-Gard™ elevated temperature spray nozzle protects the operator from extreme hot water temperatures that exceed the comfort zone of standard hot water nozzles.
- Assembly includes required special rigid, stainless steel adapter, (3/8" male NPT x 1/2" female NPT).
- Thermal insulating sleeve reduces overall heat during elevated temperature conditions.
- Stainless steel lever handle is coated for additional thermal protection and operator comfort.
- Lightweight aluminum alloy body reduces overall weight
- Aluminum alloy body is electroless nickel plated for additional corrosion protection
- Recommended for water temperatures above **140°F (60°C)** to a maximum temperature of **200°F (93°C)**
- **12.5 GPM** flow capacity
- working pressure: **150 PSI**
- 3/8" female NPT inlet
- black cover



Aluminum  
Part #  
**AWSG-TG**

## Spray Valve and Hose Assembly

### Valves

**Features:**

- even spray valve mist provides proper moisture on paper roll ends
- helps eliminate wrinkles and folder delivery problems, increasing pressroom production and reducing waste
- a slight flex of the hose in any direction (360°) activates the spray
- quick action with no protruding levers, thumb depressors, triggers or other devices utilized
- positive water seal when hose is released causes the internal valve to close and immediately shut off spray
- sealed mechanism with no packing gland



83304



83306H

Female NPT Size	Description	Part #
1/4"	valve only	<b>83304</b>
3/8"		<b>83306</b>
1/4"	valve with hook	<b>83304H</b>
3/8"		<b>83306H</b>

### Hose Assembly

Male NPT Inlet	Description	Part #
3/8"	5' hose	<b>8320605</b>

- additional hose lengths are available - contact Dixon®



Washdown Nozzles

Sweeper Nozzle



Thread Size	Discharge	Length	Brass	
			Previous Part #	Part #
3/4" GHT	3/16"	2"	500SN2	<b>PSN76</b>

Flexible Water Nozzle



Feature:

- bends for water flow, shuts off when released

Thread Size	Part #
3/4" GHT	<b>8005</b>

Brass / Rubber Power Flow Water Nozzle



Features:

- all metal body and handle
- curved design to fit the contour of your hand
- overmold for comfortable handling
- built in flow control to regulate the amount of water flow
- locking feature to make extended watering easy
- large easy-turn dial

Thread Size	Part #
3/4" GHT	<b>PNB75GHT</b>

Insulated Water Nozzles



Features:

- clip locks to any spray pattern
- industrial strength nylon handle
- rubber handle guard
- GHT thread on head
- heavy duty brass valve and adjusting nut
- for use with hot water up to **140°F (60°C)**

Thread Size	Chrome Plated Zinc Part #
3/4" GHT	<b>SN75</b>

Pistol-Grip Water Nozzle



Features:

- clip locks to any spray pattern
- easy squeeze on/off lever
- brass valve and adjusting nut
- stainless steel spring with lifetime packing
- rubber handle guard

Thread Size	Zinc Metallized Part #
3/4" GHT	<b>CSN75</b>

Twist Nozzles



Feature:

- maximum operating pressure **150 PSI** (water only)

Thread Size	Length	Extruded Brass	
		Previous Part #	Part #
3/4" GHT	4"	---	<b>BTN75</b>
	4"	---	<b>500AN4<sup>1</sup></b>
	6 3/4"	500-AN7	<b>500AN7<sup>1</sup></b>

<sup>1</sup> imported



### Adjust-A-Power Nozzle

**Features:**

- ideal for patio, auto and boat, driveway and garden
- produces 50% more power than twist nozzles
- does not require a washer
- leave nozzle in the open position when not in use
- brass construction with stainless steel bearings
- maximum operating pressure: **100 PSI** (water only) at ambient temperature **70°F (21°C)**



Thread Size	Brass Part #
3/4" GHT	<b>AAPN75GHT</b>

### Constant Flow Nozzle Displays

**Features:**

- shatterproof and UV resistant polycarbonate withstands tough environmental conditions
- seals used for true water shut off
- easy twist spray pattern adjustment
- sold in case quantity only (25 per case), with display

Thread	45° Spray GPM @ 100 PSI	Color	Global Part #
3/4" GHT	25.1	green	<b>FNB75GHT-GD</b>
	25.1	clear	<b>CNB75GHT-GD</b>



### Constant Flow Nozzles with Bumper

**Feature:**

- can be used as a replacement nozzle in the display case **FNB75GHT-GD**

Thread	45° Spray GPM @ 100 PSI	Color	Plastic Part #
3/4" GHT	8.0	green	<b>GNB75GHT</b> (domestic)
	25.1	clear	<b>CNB75GHT</b> (global)



## Water-Steam Washdown Station

**Application:**

- fail-safe mixing station safely blends steam and cold water for hot water on demand, should cold water fail, the steam is instantly shut-off

**Features:**

- globe style control valves
- dial thermometer
- in-line check valves
- ¾" inlet and outlet
- stainless steel hose rack
- mounting plate and hardware for wall mounting
- maximum operating pressure: **150 PSI**
- maximum temperature: **200°F (93°C)**



station is not supplied with hose and nozzle

Bronze  
Part #

**SWDS**

### Pressure Requirements

Steam Pressure		Water Pressure	
Minimum <b>80 PSI</b>	Maximum <b>90 PSI</b>	Minimum <b>50 PSI</b>	Maximum <b>80 PSI</b>

## Hot and Cold Water Mixing Station

**Features:**

- globe style control valves
- in-line check valves
- ¾" inlet and outlet
- stainless steel hose rack
- mounting plate and hardware for wall mounting
- maximum operating pressure: **150 PSI**
- maximum temperature: **200°F (93°C)**



station is not supplied with hose and nozzle

Bronze  
Part #

**WDS1**

## Rack for Mixing Station

**Features:**

- stainless steel lag screws
- solid brass mounting crowns
- supplied with mounting hardware
- rack fits SWDS and WDS1 mixing stations
- holds 50' of ¾" heavy duty industrial grade hose



Stainless Steel  
Part #

**WDSR**

Spray Guns  
Anti-Fatigue Spray Gun

Features:

- 3/8" female inlet
- 1/4" female outlet
- temperatures to: **300°F (149°C)**
- anti-fatigue pressure compensating design

Maximum PSI	GPM	Part #
<b>5075</b>	<b>12.0</b>	<b>HPSG</b>
<b>5000</b>	<b>10.6</b>	<b>HPSGW<sup>1</sup></b>

<sup>1</sup> W = weeping, for the car wash industry, allows a small stream of water / leak



Pressure Spray Gun

Features:

- 3/8" female inlet
- 1/4" female outlet
- working pressure: **4500 PSI**
- maximum temperature: **320°F (160°C)**

GPM	Part #
<b>8</b>	<b>HPSGL</b>



Heavy Duty Anti-Fatigue Spray Gun

Features:

- 3/8" female inlet
- 1/4" female outlet
- working pressure: **5000 PSI**
- maximum temperature: **300°F (149°C)**
- heavy duty anti-fatigue design
- stainless inner tube
- Zytel® housing

GPM	Part #
<b>8</b>	<b>HPSGHD</b>



Pressure Spray Gun with Extension

Features:

- 3/8" female inlet
- 22 mm x 14 mm female outlet
- working pressure: **3700 PSI**
- maximum temperature: **140°F (60°C)**
- extension length: 19"

GPM	Part #
<b>8</b>	<b>AL9</b>



Pressure Spray Gun Kit with Hose, Nozzle & Lance

Features:

- gun: 22 mm male inlet, 22 mm x 14 mm female outlet end, working pressure **2500 PSI**
- lance: 18" with vari-spray nozzle 1.25 mm with 22 mm male inlet
- hose: 25', 1/4" ID with 22 mm x 14 mm female ends
- nozzle: 4.0 variable nozzle 0° to 80°

Part #
<b>BIT-KIT</b>



Spray Lances and Extensions for Pressure Gun  
Spray Lance

Features:

- for use with **AL9** spray gun **only** on page 865
- maximum operating pressure: **4000 PSI**
- maximum temperature: **300°F (149°C)**



Length	Description	Zinc Part #
24"	22 mm x 14 mm male inlet x 1/4" male outlet	<b>AL248</b>

Dual Spray Lances

Features:

- for use with **HPSG, HPSGC, HPSGHD** and **HPSGW**
- for soap and water
- maximum temperature: **300°F (149°C)**
- **10.5 GPM**
- requires 1 high pressure nozzle and 1 soap nozzle on page 869
- Allows quick adjustment from high to low pressure with a twist of the handle; low pressure setting allows for use of soap.



AL333



AL344

Length	Description	Maximum Operating PSI	Part #
40"	zinc, 1/4" male inlet 2 each 1/4" female outlets	<b>3,650</b>	<b>AL333</b>
	stainless steel, 1/4" male inlet, 2 each 1/4" female outlets	<b>4,000</b>	<b>AL344</b>

Molded Grip Extensions

Features:

- for use with **HPSG, HPSGC, HPSGHD** and **HPSGW**
- maximum operating pressure: **5000 PSI**
- temperature: **300°F (149°C)**
- **10.5 GPM** maximum

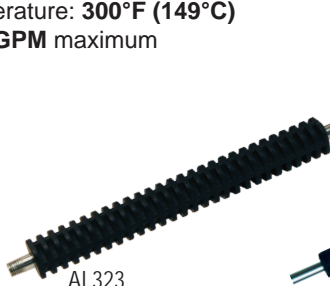

AL323



AL324



AL325 & AL326

Length	Description	Zinc Part #
24"	1/4" male inlet x 1/4" male outlet	<b>AL323XX</b>
36"	1/4" male inlet x 1/4" male outlet, 4" space from the end	<b>AL324XX</b>
48"	1/4" male inlet x 1/4" male outlet, 2 grips	<b>AL325XX</b>
59"	1/4" male inlet x 1/4" male outlet, 2 grips	<b>AL326XX</b>

Vented Grip Lances

Features:

- for use with **HPSG, HPSGC, HPSGHD** and **HPSGW**
- for hot water
- maximum operating pressure: **5000 PSI**
- maximum temperature: **300°F (149°C)**
- **10.5 GPM** maximum



AL361



AL362

Length	Description	Zinc Part #
36"	1/4" male inlet x 1/4" female outlet, straight	<b>AL361</b>
48"	1/4" male inlet x 1/4" female outlet, bent	<b>AL362</b>

## Telescoping Lance and Belt for Pressure Gun

**Features:**

- 3/8" female (pipe thread) inlet
- 1/4" female (quick connect) outlet
- maximum operating pressure: **4000 PSI**
- 1/4" steel braided hose
- **7 GPM**
- length is in three sections
- maximum temperature: **300°F (149°C)**

Length	Aluminum Part #
6' - 18'	<b>ARTEL18A</b>



### Telescoping Lance Belt

**Feature:**

- adjusts to fit a 33" to 58" waist

Nylon Part #
<b>ARTEL-BELT</b>



## Swiveling Quick Couplings

**Features:**

- working pressure: **3650 PSI**
- **7.8 GPM**
- maximum temperature: **300°F (149°C)**

### 1/4" swiveling quick couplings

Description	Part #
1/4" female x 22 mm x 1.5 mm swivel	<b>AL450</b> <sup>1</sup>
<sup>1</sup> for use with <b>AL456</b> only	



Description	Part #
1/4" male x 22 mm x 1.5 mm swivel	<b>AL451</b> <sup>2</sup>
<sup>2</sup> for use with <b>AL464</b> only	



### 3/8" swiveling quick couplings

Description	Part #
3/8" female x 22 mm x 1.5 mm swivel	<b>AL453</b> <sup>1</sup>
<sup>1</sup> for use with <b>AL456</b> only	



Description	Part #
3/8" female x female swivel	<b>AL462</b> <sup>2</sup>
<sup>2</sup> for use with <b>AL464</b> only	



## Pressure Washing

### Fixed Plugs

**Features:**

- working pressure: **3650 PSI**
- **7.8 GPM**
- maximum temperature: **300°F (149°C)**

#### 1/4" fixed quick coupling plugs



Description	Part #
1/4" female x 22 mm x 1.5 mm male	<b>AL454</b> <sup>1</sup>

<sup>1</sup> for use with **AL453** and **AL9**



Description	Part #
1/4" male x 22 mm x 1.5 mm male	<b>AL455F</b> <sup>2</sup>

<sup>2</sup> for use with **AL462** only

#### 3/8" fixed quick coupling plugs



Description	Part #
3/8" female x 22 mm x 1.5 mm male	<b>AL456</b> <sup>1</sup>

<sup>1</sup> for use with **AL453** and **AL9**



Description	<i>Nickel Plated Brass</i> Part #
3/8" female x male plug	<b>AL464</b> <sup>2</sup>

<sup>2</sup> for use with **AL462** only

### Injector Nozzles

**Features:**

- designed to inject cleaning solutions into high pressure discharge lines
- 3/8" male inlet and outlet
- maximum working pressure: **4000 PSI**



AL477

Description	Orifice	Flow (GPM)	Part #
adjustable, green	1.8 mm	2 - 3	<b>AL472</b>
adjustable, red	2.1 mm	3 - 4	<b>AL477</b>
adjustable, blue	2.3 mm	4 - 5.5	<b>AL478</b>

### Line Strainer

**Features:**

- working pressure: **100 PSI**
- 1/2" female inlet, 1/2" male outlet
- .60 mesh cuffed filter
- 2 additional 1/4" side ports
- **8 GPM** maximum



*Aluminum*  
 Part #  
**AR3000-A2**

### High Pressure Spray Soap Nozzles

Description	Brass Part #
¼" male inlet, 40° spray angle, size #40	<b>NZ4040S</b>
¼" male inlet, 80° spray angle, size #40	<b>NZ8040S</b>



### High Pressure Spray Nozzles

Description	Steel Part #
¼" male NPT inlet, 15° spray angle, size 4	<b>NZ1504</b>
¼" male NPT inlet, 25° spray angle, size 4	<b>NZ2504</b>
¼" male NPT inlet, 40° spray angle, size 4	<b>NZ4004</b>



### Quick Connect Soap Nozzle

- use with ¼" couplers on page 498

Description	Brass Part #
¼" straight through plug inlet, 65° spray angle, size #40	<b>NZ6540QCS</b>



### Quick Connect Spray Nozzles

- use with ¼" couplers on page 498

Description	Part #
¼" straight through plug inlet, 0° spray angle, size #4, red	<b>MSP400</b>
¼" straight through plug inlet, 15° spray angle, size #4, yellow	<b>MSP415</b>
¼" straight through plug inlet, 25° spray angle, size #4, green	<b>MSP425</b>
¼" straight through plug inlet, 40° spray angle, size #4, white	<b>MSP440</b>



### Multi-Pack Quick Connect Nozzles

Description	Nozzles Included	Part #
¼", 65° spray angle, size #40	NZ6540QCS	<b>MSP4PAK</b>
¼", 15° spray angle, size #4, yellow	MSP415	
¼", 25° spray angle, size #4, green	MSP425	
¼", 40° spray angle, size #4, white	MSP440	



### Multi-Pack High Pressure Spray Nozzles

- ¼" quick connect nozzle multi-packs include: 0° red, 15° yellow, 25° green, 40° white and 50° black soap nozzles
- ¼" MEG nozzle multi-packs include: 0°, 15°, 25°, 40° and 65° soap nozzles

Nozzle Size	GPM @ PSI									Part #
	800	1000	1500	2000	2500	3000	3500	4000	5000	
3.0	1.34	1.50	1.84	2.12	2.37	2.60	2.81	3.00	3.35	<b>NZMQC5P-030</b>
3.5	1.57	1.75	2.14	2.47	2.77	3.03	3.27	3.50	3.91	<b>NZMQC5P-035</b>
4.0	1.79	2.00	2.45	2.83	3.16	3.46	3.74	4.00	4.47	<b>NZMQC5P-040</b>
4.5	2.01	2.25	2.76	3.18	3.56	3.90	4.21	4.50	5.03	<b>NZMQC5P-045</b>
5.0	2.24	2.50	3.06	3.54	3.95	4.33	4.68	5.00	5.59	<b>NZMQC5P-050</b>
5.5	2.46	2.75	3.37	3.89	4.35	4.76	5.14	5.50	6.15	<b>NZMQC5P-055</b>
6.5	2.91	3.25	3.98	4.60	5.14	5.63	6.08	6.50	7.27	<b>NZMQC5P-065</b>
8.0	3.58	4.00	4.90	5.66	6.32	6.93	7.48	8.00	8.94	<b>NZMQC5P-080</b>



Nozzle Size	GPM @ PSI									Part #
	800	1000	1500	2000	2500	3000	3500	4000	5000	
3.5	1.57	1.75	2.14	2.47	2.77	3.03	3.27	3.50	3.91	<b>NZMMEG5P-035</b>
4.0	1.79	2.00	2.45	2.83	3.16	3.46	3.74	4.00	4.47	<b>NZMMEG5P-040</b>
4.5	2.01	2.25	2.76	3.18	3.56	3.90	4.21	4.50	5.03	<b>NZMMEG5P-045</b>
5.0	2.24	2.50	3.06	3.54	3.95	4.33	4.68	5.00	5.59	<b>NZMMEG5P-050</b>
5.5	2.46	2.75	3.37	3.89	4.35	4.76	5.14	5.50	6.15	<b>NZMMEG5P-055</b>



Spray Nozzle Selection Guidelines

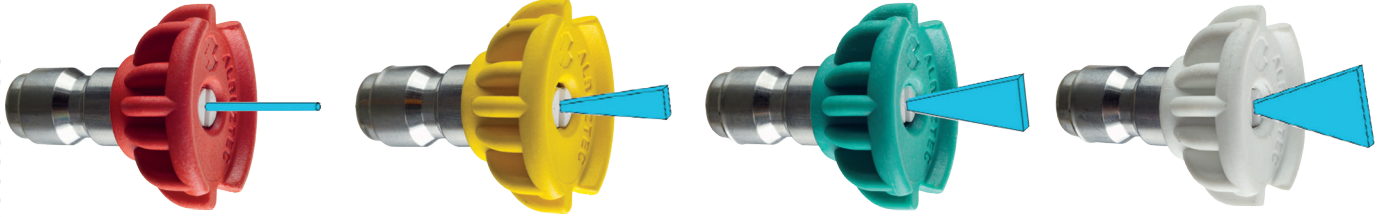

**0°  
Blasting Nozzle**

**15°  
Stripping Nozzle**

**25°  
Cleaning Nozzle**

**40°  
Washing Nozzle**

- Removing caked on mud from heavy construction, farm or lawn equipment.
- Cleaning tar, glue or stubborn stains from concrete
- Cleaning overhead areas
- Removing rust from steel and oxidation from aluminum

- Removing paint from wood, masonry or metal
- Removing grease or dirt from equipment
- Removing heavy mildew stains
- Removing marine growth from boats and marine equipment
- Removing rust from steel and oxidation from aluminum

- General cleaning of dirt, mud and grime
- Cleaning roofs, gutters and downspouts
- Removing light mildew stains
- Removing algae and bacteria build-up from pools
- Rinsing surfaces in preparation for painting

- Light cleaning and washing
- Washing and rinsing of automobiles and boats
- Cleaning roofs, windows, patios and driveways



Caution: The spray force from these nozzles can cause injuries if pointed directly at yourself or others. Before observing directly always disconnect from spray wand. Make sure spray nozzle is properly locked in place with its quick coupler, if the collar is not in the locking position, the nozzle will become a dangerous projectile. The O-ring from your quick coupler socket will also be blown out of place.

Nozzle Spray Chart

Nozzle Orifice Size	E a i l o n s  P e r  M i n u t e	1000	1200	1250	1300	1500	1800	2000	2100	2200	2300	2400	2500	3000	3200	3500	4000	5000
		PSI	PSI	PSI	PSI	PSI	PSI	PSI	PSI	PSI	PSI	PSI	PSI	PSI	PSI	PSI	PSI	PSI
3.0		1.50	1.64	1.68	1.71	1.84	2.01	2.12	2.17	2.22	2.27	2.32	2.37	2.60	2.68	2.81	3.00	3.35
3.5		1.75	1.92	1.96	2.00	2.14	2.35	2.47	2.54	2.60	2.65	2.71	2.77	3.03	3.13	3.27	3.50	3.91
4.0		2.00	2.19	2.24	2.28	2.45	2.68	2.83	2.90	2.97	3.03	3.10	3.16	3.46	3.58	3.74	4.00	4.47
4.5		2.25	2.46	2.52	2.57	2.76	3.02	3.18	3.26	3.34	3.41	3.49	3.56	3.90	4.02	4.21	4.50	5.03
5.0		2.50	2.74	2.80	2.85	3.06	3.35	3.54	3.62	3.71	3.79	3.87	3.95	4.33	4.47	4.68	5.00	5.59
5.5		2.75	3.01	3.07	3.14	3.37	3.69	3.89	3.99	4.08	4.17	4.26	4.35	4.76	4.92	5.14	5.50	6.15
6.5		3.25	3.56	3.63	3.71	3.98	4.36	4.60	4.71	4.82	4.93	5.03	5.14	5.63	5.81	6.08	6.50	7.27
8.0		4.00	4.38	4.47	4.56	4.90	5.37	5.66	5.80	5.93	6.07	6.20	6.32	6.93	7.16	7.48	8.00	8.94





Turbo Nozzles

Features:

- 15° spray angle
- maximum temperature: **195°F (91°C)**
- ceramic orifice

Nozzle Size	Description	Orifice	Maximum Working PSI	Part #
4.0	¼" female inlet, dk. green	1.30 mm	<b>3,625</b>	<b>AL-TPR25-30</b>
5.5 - 6.0	¼" female inlet, purple	1.50 mm	<b>3,625</b>	<b>AL-TPR25-50</b>
7.0 - 7.5	¼" female inlet, grey	1.70 mm	<b>3,625</b>	<b>AL-TPR25-70</b>
4.0	¼" female inlet, dk. green	1.30 mm	<b>5,075</b>	<b>AL-TPR35-30</b>
5.5	¼" female inlet, purple	1.50 mm	<b>5,075</b>	<b>AL-TPR35-50</b>
6.5	¼" female inlet, grey	1.70 mm	<b>5,075</b>	<b>AL-TPR35-70</b>



Nozzle Holders

Feature:

- maximum temperature: **300°F (149°C)**

Description	Flow (GPM)	Working PSI	Part #
adjustable hi/low nozzle holder with nozzle protector, ¼" female inlet and outlet	<b>7.8</b>	<b>3,650</b>	<b>AL414</b>
change over nozzle, ¼" female inlet, 2 each ¼" female outlets	<b>8</b>	<b>2,900</b>	<b>AL416</b>



AL414



AL416

Inlet Filter for Turbo Nozzles

Features:

- ¼" female inlet, ¼" male outlet
- maximum temperature: **212°F (100°C)**
- 100 mesh filter

Description	Flow (GPM)	Working PSI	Part #
stainless steel, inlet water filter	<b>8</b>	<b>5,000</b>	<b>AR3500</b>



Balance Release Valve

Features:

- working PSI: **4,000 PSI**
- maximum temperature: **195°F (90.6°)**
- GPM: **6.6**
- inlet/outlet: ⅜" female NPT
- bypass: ⅜" female NPT

Brass
Part #
<b>AL702</b>



Water Broom

Features:

- working PSI: **4,000 PSI**
- ¼" quick connect plug

Description	Length	Stainless Steel Part #
4 nozzle broom	16"	<b>AR-BROOM16</b>



Unloader Valves



**Features:**

- automatically relieves pressure from the pump at shut-off
- maximum temperature: **190°F (88°C)**
- inlet: 2 each, 3/8" female NPT
- outlet: 3/8" female NPT
- bypass: 2 each, 3/8" female NPT

Description	Maximum Flow (GPM)	Working PSI	Part #
yellow spring	8	<b>2,320</b>	<b>AL605</b>
blue spring	8	<b>3,650</b>	<b>AL606</b>
black spring	8	<b>4,500</b>	<b>AL607</b>



**Features:**

- maximum temperature: **190°F (88°C)**
- inlet: 3/8" female
- outlet: 3/8" male
- bypass: 3/8" female

Description	Flow (GPM)	Working PSI	Part #
VR-35 unloader valve	9	<b>5,100</b>	<b>AR20831</b>

Thermal Relief Valve



**Features:**

- operating PSI: **200 PSI**
- maximum temperature: **140°F (60°C)**
- inlet: 1/2" male

Brass
Part #
<b>TPP140</b>

Safety Release Valve



**Features:**

- pressure range: **1,000 to 4,000 PSI**
- maximum temperature: **200°F (93°C)**
- inlet: 3/8" male
- GPM: **6**

Part #
<b>AR5000-1</b>

<b>Mill Hose</b> .....	<b>874 to 877</b>	<b>PTFE Hose</b> .....	<b>893, 896</b>
Synthetic single jacket.....	874 to 876	Nominal .....	893
Synthetic double jacket.....	877	Fittings .....	894
		Tool and dies.....	894, 895
<b>Washdown Hose</b> .....	<b>878 to 880</b>	Smooth bore fitting.....	895
Nitrile .....	878 to 879, 880	True ID.....	896
Hot water .....	880	Fittings .....	896, 897
Pressure washer braided.....	880	Crimp collars .....	897
Hand crank hose reel .....	880		
		<b>Hose Protection</b> .....	<b>898 to 900</b>
<b>Racks &amp; Reels</b> .....	<b>881 to 882</b>	Spiral hose and cable protection .....	898
Reelcraft® 5000 series spring driven.....	881	Fiberglass sleeving.....	899
Reelcraft® 7000 series .....	881	Kevlar® protective sleeves .....	899
Reelcraft® 80000 series .....	882	Nylon protective sleeves - MSHA accepted.....	899
Adjustable hose bumper stops .....	882	Spring Guard .....	900
Reelcraft® 30,000 manual driven .....	882	Continuous Spring Guard.....	900
Hand crank .....	882	GSM ball joint armored hose assemblies.....	900
<b>Garden Hose &amp; Washdown</b> .....	<b>883 to 885</b>		
Contractors EPDM water hose .....	883		
Rubber vinyl garden hose.....	883		
Premium EPDM hose.....	883		
Flexogen® hose.....	883		
Perfect water hose.....	884		
Premium Flexzilla® garden hose .....	884		
Top Level PVC hose .....	884		
Hot Water rubber reinforced hose .....	884		
Marine, Camper, Patio & Pool hose .....	885		
Country Club® RT hose .....	885		
<b>Flexible Tubing</b> .....	<b>886 to 889</b>		
PVC .....	886		
PVC braided .....	887		
D.O.T. air brake .....	887		
Polyurethane .....	888		
Polyethylene.....	888		
Nylon .....	888		
Legris nylon .....	889		
Polyurethane - 95 durometer.....	889		
Fluoropolymer FEP 140.....	889		
<b>Air Hose</b> .....	<b>890 to 891</b>		
Coil-Chief self-storing .....	890		
Polyurethane self-storing.....	891		
Polyurethane .....	891		
<b>Tubing &amp; Hose Cutters</b> .....	<b>892</b>		

Fire hoses are located on pages 732 to 739

## Synthetic Single Jacket Mill Hose

**Application:**

- used in open end water discharge applications only, not intended for fire fighting service

**Features:**

- outer construction: single jacket, all polyester
- tube construction: black, PVC rubber
- rated pressure: **250 PSI** at ambient temperature **70°F (21°C)**
- working pressure: **112 PSI** at ambient temperature **70°F (21°C)**
- Consult Dixon® for pricing and availability on 75' lengths and other threads and configurations.

**Uncoupled**

Size	Bowl	Length	Part #
1"	1-1/4"	50'	<i>M10-50UC</i>
	1-1/4"	100'	<i>M10-100UC</i>
	1-1/4"	300'	<i>M10-300UC</i>
1½"	1-11/16"	25'	<i>M15-25UC</i>
	1-11/16"	50'	<i>M15-50UC</i>
	1-11/16"	100'	<i>M15-100UC</i>
2"	2-3/8"	25'	<i>M20-25UC</i>
	2-3/8"	50'	<i>M20-50UC</i>
	2-3/8"	100'	<i>M20-100UC</i>
2½"	2-11/16"	25'	<i>M25-25UC</i>
	2-11/16"	50'	<i>M25-50UC</i>
	2-11/16"	100'	<i>M25-100UC</i>
3"	3-3/8"	25'	<i>M30-25UC</i>
	3-3/8"	50'	<i>M30-50UC</i>
	3-3/8"	100'	<i>M30-100UC</i>
4"	4-3/8"	25'	<i>M40-25UC</i>
	4-3/8"	50'	<i>M40-50UC</i>
	4-3/8"	100'	<i>M40-100UC</i>
6"	6-3/8"	25'	<i>M60-25UC</i>
	6-3/8"	50'	<i>M60-50UC</i>

## Synthetic Single Jacket Mill Hose

**Application:**

- used in open end water discharge applications only, not intended for fire fighting service



**Features:**

- outer construction: single jacket, all polyester
- tube construction: black, PVC rubber
- rated pressure: **250 PSI** at ambient temperature **70°F (21°C)**
- working pressure: **125 PSI** at ambient temperature **70°F (21°C)**
- Consult Dixon® for pricing and availability on 75' lengths and other threads and configurations.

**Coupled with NPSH female and male expansion ring couplings**

Size	Length	Part #
1½"	50'	<i>M15-50RAS</i>
	100'	<i>M15100RAS</i>
2"	50'	<i>M20-50RAS</i>
	100'	<i>M20100RAS</i>
2½"	50'	<i>M25-50RAS</i>
	100'	<i>M25100RAS</i>



**Coupled with NST (NH) female and male expansion ring couplings**

Size	Length	Part #
1½"	50'	<i>M15-50RAF</i>
	100'	<i>M15100RAF</i>
2½"	25'	<i>M25-25RAF</i>
	50'	<i>M25-50RAF</i>
	100'	<i>M25100RAF</i>



**Coupled with MNPT x MNPT male expansion ring couplings**

Size	Length	Part #
1½"	50'	<i>M15-50RAT</i>
	100'	<i>M15100RAT</i>
2"	50'	<i>M20-50RAT</i>
	100'	<i>M20100RAT</i>



## Synthetic Single Jacket Mill Hose

**Application:**

- used in open end water discharge applications only, not intended for fire fighting service



**Features:**

- outer construction: single jacket, all polyester
- tube construction: black, PVC rubber
- Consult Dixon® for pricing and availability of additional lengths and other configurations.

**Coupled with NPSH female and male King™ short shank couplings, crimp sleeve, aluminum shank with brass pin lug swivel nut**

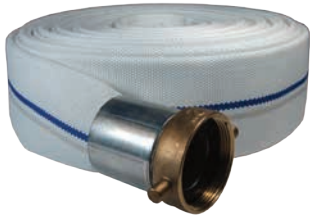

Size	Length	Working Pressure PSI at 70°F (21°C)	Part #
1½"	25'	75	M15-25KAS
	50'	75	M15-50KAS
2"	25'	75	M20-25KAS
	50'	75	M20-50KAS
2½"	25'	50	M25-25KAS
	50'	50	M25-50KAS
3"	25'	50	M30-25KAS
	50'	50	M30-50KAS

**Coupled with NST (NH) female and male King™ short shank couplings, crimp sleeve, aluminum shank with brass pin lug swivel nut**

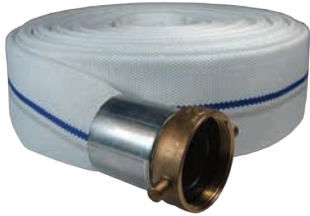

Size	Length	Working Pressure PSI at 70°F (21°C)	Part #
1½"	25'	75	M15-25KAF
	50'	75	M15-50KAF
2½"	25'	50	M25-25KAF
	50'	50	M25-50KAF

**Coupled with female and male (C & E) global aluminum cam and groove, crimp sleeve**



Size	Length	Working Pressure PSI at 70°F (21°C)	Part #
1½"	25'	112	M15-25GAX
	50'	112	M15-50GAX
2"	25'	112	M20-25GAX
	50'	112	M20-50GAX
2½"	25'	112	M25-25GAX
	50'	112	M25-50GAX
3"	25'	112	M30-25GAX
	50'	112	M30-50GAX
4"	25'	112	M40-25GAX
	50'	112	M40-50GAX

Synthetic Double Jacket Mill Hose

Application:

- ideal for open end discharge applications, not intended for fire fighting service 

Features:

- outer construction: double jacket, all polyester
- tube construction: black, PVC rubber
- rated pressure: **250 PSI at 70°F (21°C)**
- working pressure: **200 PSI at 70°F (21°C)**
- double jacket hoses are **not** recommended for use with field reattachable couplings 
- Consult Dixon® for pricing and availability of additional lengths and other configurations.

Hose & Tubing

Uncoupled

Size	Bowl	Length	Part #
1½"	1-13/16"	50'	<b>DM15-50UC</b>
	1-13/16"	100'	<b>DM15-100UC</b>
2"	2-5/16"	50'	<b>DM20-50UC</b>
	2-5/16"	100'	<b>DM20-100UC</b>
2½"	2-7/8"	50'	<b>DM25-50UC</b>
	2-7/8"	100'	<b>DM25-100UC</b>



Coupled with female and male NST (NH) thread, rocker lug, aluminum expansion ring couplings

Size	Bowl	Length	Part #
1½"	1-13/16"	50'	<b>DM15-50RAF</b>
	1-13/16"	100'	<b>DM15100RAF</b>
2½"	2-7/8"	50'	<b>DM25-50RAF</b>
	2-7/8"	100'	<b>DM25100RAF</b>



Coupled with female and male NPSH thread, rocker lug, aluminum expansion ring couplings

Size	Bowl	Length	Part #
1½"	1-13/16"	50'	<b>DM15-50RAS</b>
	1-13/16"	100'	<b>DM15100RAS</b>
2"	2-5/16"	50'	<b>DM20-50RAS</b>
	2-5/16"	100'	<b>DM20100RAS</b>
2½"	2-7/8"	50'	<b>DM25-50RAS</b>
	2-7/8"	100'	<b>DM25100RAS</b>



Coupled with female and male NPT thread, rocker lug, aluminum expansion ring couplings

Size	Bowl	Length	Part #
1½"	1-13/16"	50'	<b>DM15-50RAT</b>
	1-13/16"	100'	<b>DM15100RAT</b>
2"	2-5/16"	50'	<b>DM20-50RAT</b>
	2-5/16"	100'	<b>DM20100RAT</b>
2½"	2-7/8"	50'	<b>DM25-50RAT</b>



Coupled with female and male (C & E) global aluminum cam and groove, crimp sleeve

Size	Bowl	Length	Part #
1½"	1-13/16"	50'	<b>DM15-50GAX</b>
	1-13/16"	100'	<b>DM15100GAX</b>
2"	2-5/16"	50'	<b>DM20-50GAX</b>
	2-5/16"	100'	<b>DM20100GAX</b>

**NEW**



## Nitrile Washdown Hose

**Application:**

- ideal for industrial, agricultural and construction washdown and discharge applications, not for firefighting

**Features:**

- resistant to weather and abrasion
- working pressure: **200 PSI**

**Coupled with NPSH female and male expansion ring couplings**

Size	Length	Part #
1½"	50'	<i>WDH15BK50RAS</i>
	100'	<i>WDH15BK100RAS</i>
2"	50'	<i>WDH20BK50RAS</i>
	100'	<i>WDH20BK100RAS</i>
2½"	50'	<i>WDH25BK50RAS</i>
	100'	<i>WDH25BK100RAS</i>

**Coupled with NST female and male expansion ring couplings**

Size	Length	Part #
1½"	50'	<i>WDH15BK50RAF</i>
	100'	<i>WDH15BK100RAF</i>
2½"	25'	<i>WDH25BK25RAF</i>
	50'	<i>WDH25BK50RAF</i>
	100'	<i>WDH25BK100RAF</i>

**Coupled with MNPT x MNPT male expansion ring couplings**

Size	Length	Part #
1½"	50'	<i>WDH15BK50RAT</i>
	100'	<i>WDH15BK100RAT</i>
2"	50'	<i>WDH20BK50RAT</i>
	100'	<i>WDH20BK100RAT</i>



## Nitrile Washdown Hose

**Application:**

- ideal for industrial, agricultural, chemical and construction washdown and discharge applications, not for firefighting

**Feature:**

- resistant to weather and abrasion

**Coupled with NPSH female and male King™ short shank couplings, crimp sleeve, aluminum shank with brass pin lug swivel nut**

Size	Length	Part #
1½"	25'	<i>WDH15BK25KAS</i>
	50'	<i>WDH15BK50KAS</i>
2"	25'	<i>WDH20BK25KAS</i>
	50'	<i>WDH20BK50KAS</i>
2½"	25'	<i>WDH25BK25KAS</i>
	50'	<i>WDH25BK50KAS</i>
3"	25'	<i>WDH30BK25KAS</i>
	50'	<i>WDH30BK50KAS</i>



**Coupled with NST (NH) female and male King™ short shank couplings, crimp sleeve, aluminum shank with brass pin lug swivel nut**

Size	Length	Part #
1½"	25'	<i>WDH15BK25KAF</i>
	50'	<i>WDH15BK50KAF</i>
2½"	25'	<i>WDH25BK25KAF</i>
	50'	<i>WDH25BK50KAF</i>



**Coupled with female and male (C & E) global aluminum cam and groove, crimp sleeve**

Size	Length	Part #
1½"	25'	<i>WDH15BK25GAX</i>
	50'	<i>WDH15BK50GAX</i>
2"	25'	<i>WDH20BK25GAX</i>
	50'	<i>WDH20BK50GAX</i>
2½"	25'	<i>WDH25BK25GAX</i>
	50'	<i>WDH25BK50GAX</i>
3"	25'	<i>WDH30BK25GAX</i>
	50'	<i>WDH30BK50GAX</i>
4"	25'	<i>WDH40BK25GAX</i>
	50'	<i>WDH40BK50GAX</i>



Nitrile Washdown Hose

Application:

- ideal for industrial, agricultural and construction washdown and discharge applications, not for firefighting 

Feature:

- resistant to weather and abrasion

Uncoupled



Size	Color	Bowl	Length	Working Pressure	Part #
1"	black	1¼"	50'	200 PSI	<i>WDH10BK50UC</i>
	black	1¼"	100'		<i>WDH10BK100UC</i>
	yellow	1¼"	100'		<i>WDH10Y100UC</i>
	blue	1¼"	100'		<i>WDH10BL100UC</i>
1½"	black	1-13/16"	50'		<i>WDH15BK50UC</i>
	black	1-13/16"	100'		<i>WDH15BK100UC</i>
2"	black	2-5/16"	50'		<i>WDH20BK50UC</i>
	black	2-5/16"	100'		<i>WDH20BK100UC</i>
2½"	black	2-13/16"	50'		<i>WDH25BK50UC</i>
	black	2-13/16"	100'		<i>WDH25BK100UC</i>
3"	black	3⅜"	50'	150 PSI	<i>WDH30BK50UC</i>
	black	3⅜"	100'		<i>WDH30BK100UC</i>
4"	black	4⅜"	50'		<i>WDH40BK50UC</i>
	black	4⅜"	100'		<i>WDH40BK100UC</i>
6"	black	6⅜"	50'		<i>WDH60BK50UC</i>
	black	6⅜"	100'		<i>WDH60BK100UC</i>

Hot Water Washdown Hose

Features:

- smooth extruded Chlorobutyl tube
- white, wrapped Hypalon cover (.075" thick) with braided textile reinforcement
- furnished with internal stainless steel spring guards at both ends
- ¾" male on one end and ½" male on the other
- working pressure: **250 PSI**
- maximum temperature: **200°F (93°C)**



Hose ID x Length	Part #
¾" x 25'	<i>SWDSHOSE25</i>
¾" x 50'	<i>SWDSHOSE50</i>

Pressure Washer Braided Hose

Feature:

- maximum temperature: **250°F (121°C)**



ID	Male Swivel Inlet	Male Swivel Outlet	Pressure Rating (PSI)	Length	Rubber Part #
¾"	¾"	¾"	<b>4,000</b>	50'	<i>AR503830SSP</i>

## Reelcraft® 5000 Series Spring Driven Hose Reels

## Features:

- reel inlet  $\frac{3}{8}$ " NPTF
- all steel construction
- full shaft and swivel
- supplied standard with PVC hose
- maximum temperature: **150°F (66°C)**
- Compressed air hose should not be converted to oxygen service; they are often contaminated with an oil coating, which can react explosively when oxygen is introduced.



## with hose

Hose ID	Hose Length	Service	Working Pressure PSI	Part #
$\frac{1}{4}$ "	50'	air / water	<b>300</b>	<b>5450LP</b>
$\frac{3}{8}$ "	35'	air / water	<b>300</b>	<b>5635LP</b>
	50'	air / water	<b>300</b>	<b>5650LP</b>

## without hose

Hose Capacity	Service	Working Pressure PSI	Part #
50' of $\frac{1}{4}$ " or 35' of $\frac{3}{8}$ "	air / water	<b>500</b>	<b>5600LP</b>
50' of $\frac{3}{8}$ "	air / water	<b>500</b>	<b>5605LP</b>

## Reelcraft® 7000 Series Spring Driven Hose Reels

## Features:

- all steel construction
- LP Low Pressure reels:
  - maximum temperature **150°F (66°C)**
  - reel inlet  $\frac{1}{2}$ " NPTF
  - PVC hose is standard
- MP Medium Pressure reels:
  - maximum temperature **210°F (99°C)**
  - reel inlet  $\frac{1}{2}$ " NPTF
  - SAE 100 R1T 1-wire braid hose available
- HP High Pressure reels:
  - maximum temperature **210°F (99°C)**
  - reel inlet  $\frac{1}{4}$ " NPTF
  - SAE 100 R2T 2-wire braid hose available

## with hose

Hose ID	Hose Length	Service	Working Pressure PSI	Part #
$\frac{3}{8}$ "	70'	air / water	<b>300</b>	<b>7670LP</b>
$\frac{1}{2}$ "	50'	air / water	<b>300</b>	<b>7850LP</b>

## without hose

Hose Capacity	Service	Working Pressure PSI	Part #
70' of $\frac{3}{8}$ " , 50' of $\frac{1}{2}$ "	air / water	<b>500</b>	<b>7800LP</b>
50' of $\frac{3}{8}$ " or 50' of $\frac{1}{2}$ "	oil	<b>3000</b>	<b>7800MP</b>
50' of $\frac{1}{4}$ " or 50' of $\frac{3}{8}$ "	grease	<b>5000</b>	<b>7600HP</b>



Reelcraft® 80000 Series Spring Driven Hose Reels

Hose & Tubing



see below for bumper stops, consult Dixon® for uses other than stated services

Features:

- reel inlet ¾" NPTF
- five-in-one heat treated aluminum casting incorporates main shaft, ratchet, spring arbor and inlet/outlet plumbing in one-piece casting
- furnished standard with PVC hose
- maximum temperature is **150°F (66°C)** with hose
- maximum temperature is **210°F (99°C)** without hose

with hose

Hose ID	Hose Length	Service	Working Pressure PSI	Part #
½"	75'	air / water	<b>300</b>	<b>82075LP</b>
	100'	air / water	<b>300</b>	<b>82100LP</b>
¾"	50'	air / water	<b>250</b>	<b>83050LP</b>

without hose

Hose Capacity	Service	PSI	Part #
50' of ¾" or 100' of ½"	air / water	<b>500</b>	<b>83000LP</b>

Adjustable Hose Bumper Stops

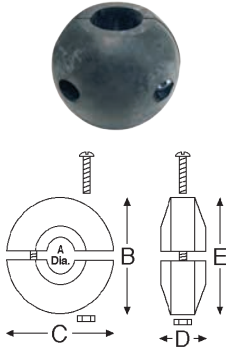

Hose ID	Hose OD		Dimensions		Reel Series Used On	Part #
	From:	To:	B,C,E	D		
¼"	.438"	.625"	2½"	1¼"	5000	<b>1-HR1004A</b>
⅜"	.625"	.749"	2½"	1¼"	5000	<b>1-HR1004</b>
⅜"	.625"	.749"	3"	1¼"	7000	<b>1-HR1004-3</b>
½" or ⅜" 2-wire	.750"	1.050"	3"	1¼"	7000	<b>2-HR1004-3</b>
¾"	1.060"	1.300"	3"	1¼"	7000	<b>3-HR1004-3</b>
½"	.750"	1.050"	3½"	2⅞"	9000	<b>2-HR1005</b>
¾"	1.060"	1.380"	3½"	2⅞"	9000	<b>3-HR1005</b>
1"	1.390"	1.550"	3½"	2⅞"	9000	<b>4-HR1005</b>

- not included on hose reels ordered without hose, must order separately

Reelcraft® 30,000 Manual Driven Hose Reels



Features:

- reel frame, spool and drum are fabricated from heavy gauge steel
- all bolted construction - no welds
- manual driven standard
- motor drive available
- ½" inlet

without hose

Hose ID	Hose Capacity	Spool Width	Working Pressure PSI	Part #
¾"	100'	12"	1000	<b>C33112L</b>
½"	200'	12"	3000	<b>C32112M</b>

Hand Crank Hose Reel



Features:

- working PSI: **3,000 PSI**
- maximum temperature: **160°F (71°C)**
- ⅜" outlet, ⅜" inlet
- includes jumper hose, mounting bracket and crank handle
- holds 100' of ⅜" pressure hose

Steel  
Part #

**AR-REEL100**

## Contractors EPDM Water Hose

**Features:**

- heavy duty, crush proof solid brass couplings with wrench grips
- spiral synthetic cord reinforcement
- black cover
- working pressure: **150 PSI**
- temperature range: **-20°F to 180°F (-29°C to 82°C)**

Size	EPDM Part #	Optional Qty
¾" x 50'	<b>CWH50</b>	3



Hose &amp; Tubing

## Rubber Vinyl Garden Hose

**Features:**

- extra tough, five-ply construction
- exclusive, soft textured, abrasion-resistant green cover
- dual reinforced, heavy-duty, flexibility, kink resistance
- combines durability of rubber, easy handling of vinyl
- SEAL-TITE® leakproof coupling
- working pressure: **400 PSI**
- temperature range: **0°F to 140°F (-18°C to 60°C)**

Size	Rubber Vinyl Part #	Optional Qty
⅝" x 25'	<b>SGH25</b>	5
⅝" x 50'	<b>SGH50</b>	5
⅝" x 75'	<b>SGH75</b>	3
⅝" x 100'	<b>SGH100</b>	3



## Premium EPDM Hose

**Features:**

- professional grade reinforcement provides maximum strength
- heavy-duty flexibility
- ultimate kink resistance
- SEAL-TITE® leakproof coupling
- lead-free drinking water safe
- 40% lighter than standard rubber hose
- black cover
- working pressure: **400 PSI**
- temperature range: **-40°F to 165°F (-40°C to 74°C)**

Size	EPDM Part #	Optional Qty
⅝" x 50'	<b>PGH50</b>	4
⅝" x 100'	<b>PGH100</b>	4



## Flexogen® Hose

**Features:**

- heavy-duty, crush resistant, full-flow brass couplings with a built-in washer for tight sealing
- coils and handles easily in all weather
- lightweight patented 8-ply construction
- maximum kink resistance
- flow guard plus protective collar resists kinks at faucet
- polished surface resists abrasions, stains and mildew
- grey cover

Size	Flexogen® Part #
⅝" x 25'	<b>FGH25</b>
⅝" x 50'	<b>FGH50</b>





Perfect Water Hose

Features

- for residential and industrial use
- lightweight, easy handling
- heavy duty male and female garden hose fittings
- blue cover
- polypropylene double helix construction with TPE cover
- flexible and kink-free
- working pressure: **100 PSI at 70°F (21°C)**
- burst pressure: **300 PSI at 70°F (21°C)**
- temperature range: **-20°F to 158°F (-29°C to 70°C)**

Size	Part #
5/8" x 25'	<b>PWH25</b>
5/8" x 50'	<b>PWH50</b>
5/8" x 100'	<b>PWH100</b>

Premium Flexzilla® Garden Hose

Features:

- temperature range: **-40°F to 150°F (-40°C to 66°C)**
- anodized aircraft aluminum fittings 3/4" - 1 1/2" GHT fittings on both ends of hose
- kink resistant under pressure
- no memory - lays flat, coils easily
- abrasion resistant
- rugged bend restrictors
- lightweight
- lime green cover



Size	Hybrid Polymer Part #
5/8" x 50'	<b>KRH50</b>
5/8" x 75'	<b>KRH75</b>
5/8" x 100'	<b>KRH100</b>

Top Level PVC Hose

Features:

- heavy-duty 3/4" brass couplings
- kink resistant
- green cover
- working pressure: **100 PSI**
- temperature range: **15°F to 150°F (-9°C to 66°C)**



Size	PVC Part #
5/8" x 50'	<b>GGH50</b>
5/8" x 75'	<b>GGH75</b>

Hot Water Rubber Reinforced Hose

Features:

- industrial style reinforcing for flexibility, high burst strength
- extra heavy-duty, crush-proof, machined brass couplings
- maximum wear, abrasion-resistant red cover
- lead-free drinking water safe
- 40% lighter than standard rubber hose
- withstands extensive hot water up to **-40°F to 165°F (-40°C to 74°F)**
- working pressure: **400 PSI**



Size	Rubber Part #	Optional Qty
5/8" x 50'	<b>HWH50</b>	4
3/4" x 50'	<b>HWH50-75</b>	4

Marine, Camper, Patio & Pool Hose

**Features:**

- lightweight to handle, easy to store
- USFDA - approved tube materials for food contact use
- nickel plated couplings
- lead-free drinking water safe
- white cover
- working pressure: **300 PSI** at ambient temperature **70°F (21°C)**



Hose & Tubing

Size	Part #	Optional Qty
5/8" x 50'	<b>MCH50</b>	5

Country Club® RT Hose

**Features:**

- for golf courses, parks, nurseries
- premium PVC for high strength, flexibility
- lightweight, easy handling
- industrial knit reinforcing for kink resistance
- heavy duty 1" NPSH brass couplings
- green cover
- working pressure: **150 PSI** at ambient temperature **70°F (21°C)**
- burst pressure: **450 PSI**



Size	PVC Part #	Optional Qty
1" x 50'	<b>CCH50</b>	2

## PVC Tubing

**Application:**

- for use with standard shank fittings in low pressure liquid and pneumatic applications

**domestic****Features:**

- for non-critical hospital use such as suction and draining
- made from non-toxic ingredients conforming to FDA and 3A standards
- shipped in individually boxed bundles, *sold only in lengths shown below*
- maximum temperature: **175°F (79°C)**



Size		Working Pressure PSI @ 72°F (22°C)	Length	Clear PVC Part #
OD	ID			
5/16"	3/16"	55	100'	CL0305
3/8"	1/4"	55	100'	CL0406
1/2"	1/4"	70	100'	CL0408
7/16"	5/16"	50	100'	CL0507
1/2"	3/8"	40	100'	CL0608
5/8"	3/8"	65	100'	CL0610
5/8"	1/2"	30	100'	CL0810
3/4"	1/2"	45	100'	CL0812
7/8"	5/8"	40	100'	CL1014
1"	3/4"	35	100'	CL1216
1-1/4"	1"	28	100'	CL1620
1-3/4"	1-1/4"	45	50'	CL2028-50
2"	1-1/2"	40	50'	CL2432-50

**imported****Features:**

- temperature range: **14°F to 149°F (-10°C to 65°C)**
- shipped in bundles wrapped with PVC film, *sold only in lengths shown below*



Size		Working Pressure PSI @ 72°F (22°C)	Length	Clear PVC Part #
OD	ID			
3/8"	1/4"	50	100'	ICL0406
1/2"	3/8"	35	100'	ICL0608
5/8"	1/2"	35	100'	ICL0810
3/4"	1/2"	50	100'	ICL0812
1"	3/4"	35	100'	ICL1216
1 1/4"	1"	30	100'	ICL1620
2"	1 1/2"	15	50'	ICL2432



## PVC Braided Tubing

## Application:

- for use with standard shank fittings in low pressure liquid and pneumatic applications

## domestic

## Features:

- high grade tensile strength polyester yarn reinforcement
- temperature range: **27°F to 150°F (-3°C to 66°C)**
- shipped in coils, *sold only in lengths shown below*

Size		Working Pressure PSI @ 72°F (22°C)	Length	Clear PVC Part #
OD	ID			
.394	3/16"	<b>315</b>	300'	<b>BR0306</b>
.435	1/4"	<b>315</b>	300'	<b>BR0446</b>
.625	3/8"	<b>265</b>	300'	<b>BR0609</b>
.728	1/2"	<b>215</b>	300'	<b>BR0812</b>
.906	5/8"	<b>200</b>	300'	<b>BR1014</b>
1.024	3/4"	<b>150</b>	300'	<b>BR1218</b>
1.732	1-1/4"	<b>110</b>	100'	<b>BR2027</b>
1.950	1-1/2"	<b>90</b>	100'	<b>BR2431</b>



## imported

## Features:

- for various machine tools and the transportation of chemicals
- temperature range: **14°F to 149°F (-10°C to 65°C)**
- shipped in bundles wrapped with PVC film, *sold only in lengths shown below*

Size		Working Pressure PSI @ 72°F (22°C)	Length	Clear PVC Part #
OD	ID			
1/2"	1/4"	<b>142</b>	300'	<b>IBR0446</b>
5/8"	3/8"	<b>114</b>	300'	<b>IBR0609</b>
3/4"	1/2"	<b>100</b>	300'	<b>IBR0812</b>
1-1/16"	3/4"	<b>71</b>	300'	<b>IBR1218</b>
1-5/16"	1"	<b>71</b>	200'	<b>IBR1621</b>



## D.O.T. Air Brake Tubing Rolls

## Features:

- meets Department of Transportation FMVSS-106 nylon material conforming to SAE J844
- working pressure: **150 PSI**
- temperature range: **-40°F to 200°F (-40°C to 93°C)**
- tubing cutters sold on page 892

Tube Size	Tubing Color	Length	Nylon Part #
3/16"	black	100'	<b>J844-03-BL-100</b>
1/4"	black	100'	<b>J844-04-BL-100</b>
	blue	100'	<b>J844-04-B-100</b>
	red	100'	<b>J844-04-R-100</b>
3/8"	black	100'	<b>J844-06-BL-100</b>
	blue	100'	<b>J844-06-B-100</b>
	red	100'	<b>J844-06-R-100</b>
1/2"	black	100'	<b>J844-08-BL-100</b>
5/8"	black	100'	<b>J844-10-BL-100</b>
3/4"	black	100'	<b>J844-12-BL-100</b>



### Polyurethane Tubing

**Features:**

- naturally transparent
- temperature range: **-40°F to 165°F (-40°C to 74°C)**
- for use with the push-in fittings sold on pages 342-350
- excellent memory, flexibility and resistance to kinking
- good resistance to fuels and oils
- low gas and vapor permeability
- high compressive strength
- low compressive set and extractability levels
- outstanding abrasion resistance



Size		Wall	Working Pressure	Length	Polyurethane Part #
OD	ID	Thickness	PSI @ 75°F (24°C)		
1/8"	.062"	.0295"	<b>255</b>	250'	<b>04063</b>
5/32"	.094"	.0315"	<b>210</b>	100'	<b>05094</b>
1/4"	.160"	.0450"	<b>175</b>	100'	<b>08160</b>
3/8"	.245"	.0650"	<b>170</b>	100'	<b>12250</b>
1/2"	.320"	.0900"	<b>175</b>	50'	<b>16320</b>

### Polyethylene Tubing

**Features:**

- designed for FDA applications, complies with 21CFR 177.1520 (c) food contact
- temperature range: **-50°F to 140°F (-46° to 60°C)**
- for use with the push-in fittings sold on pages 342-350
- flexible, lightweight, low-density polyethylene (LLDPE) tubing
- for use with plastic or metal inserts with outer sleeve; ferrule or clamps
- formulated to resist stress cracking



Size		Wall	Working Pressure	Length	Tubing Color	Polyethylene Part #
OD	ID	Thickness	PSI @ 75°F (24°C)			
1/4"	.125"	.062"	<b>350</b>	100'	natural	<b>0804</b>
1/4"	.170"	.040"	<b>150</b>	100'	natural	<b>0817</b>
1/4"	.170"	.040"	<b>150</b>	100'	blue	<b>0817BL100</b>
3/8"	.250"	.062"	<b>150</b>	100'	natural	<b>1208</b>
1/2"	.375"	.062"	<b>125</b>	100'	natural	<b>1612</b>

Size		Wall	Working Pressure	Length	Tubing Color	Polyethylene Part #
OD	ID	Thickness	PSI @ 75°F (24°C)			
1/4"	.170"	.040"	<b>150</b>	500'	blue	<b>0817BL</b>
1/4"	.170"	.040"	<b>150</b>	500'	black	<b>0817BR</b>
1/4"	.170"	.040"	<b>150</b>	500'	natural	<b>0817CR</b>
3/8"	.250"	.062"	<b>150</b>	500'	black	<b>1208BR</b>
3/8"	.250"	.062"	<b>150</b>	500'	natural	<b>1208CR</b>

### Nylon Tubing

**Features:**

- naturally transparent
- temperature range: **-40°F to 180°F (-40°C to 82°C)**
- for use with the push-in fittings sold on pages 342-350
- recommended for applications requiring low density, lightweight toughness, flexibility and chemical resistance
- packaged in plastic bags



Size		Wall	Working Pressure	Length	Nylon Part #
OD	ID	Thickness	PSI @ 75°F (24°C)		
1/8"	.093"	.016"	<b>270</b>	100'	<b>04093</b>
5/32"	.106"	.025"	<b>350</b>	100'	<b>05106</b>
3/16"	.138"	.025"	<b>260</b>	100'	<b>06138</b>
1/4"	.170"	.040"	<b>330</b>	100'	<b>08170</b>
1/4"	.180"	.035"	<b>290</b>	100'	<b>08180</b>
3/8"	.275"	.050"	<b>250</b>	100'	<b>12275</b>
1/2"	.375"	.062"	<b>240</b>	100'	<b>16375</b>

Tubing cutters sold on page 892

## Legris Nylon Tubing

**Application:**

- ideal for many industrial applications

**Features:**

- chemical, humidity and abrasive resistant
- semi rigid
- temperature range: **-65°F to 200°F (-54°C to 93°C)**



Size		Wall Thickness	Working Pressure PSI @ 75°F (24°C)	Length	Natural Nylon Part #	Black Nylon Part #	Blue Nylon Part #
OD	ID						
1/8"	.093"	.016"	250	50'	1091P5300	1091P5301	1091P5304
5/32"	.106"	.025"	300	50'	1091P0400	1091P0401	1091P0404
3/16"	.138"	.025"	250	50'	1091P5500	1091P5501	---
1/4"	.170"	.040"	300	50'	1091P5600	1091P5601	1091P5604
5/16"	.233"	.040"	250	50'	1091P0800	1091P0801	1091P0804
3/8"	.275"	.050"	250	50'	1091P6000	1091P6001	1091P6004
1/2"	.375"	.062"	250	50'	1091P6200	1091P6201	1091P6204

Size		Wall Thickness	Working Pressure PSI @ 75°F (24°C)	Length	Natural Nylon Part #	Black Nylon Part #	Blue Nylon Part #
OD	ID						
1/8"	.093"	.016"	250	100'	1094P5300	1094P5301	1094P5304
5/32"	.106"	.025"	300	100'	1094P0400	1094P0401	1094P0404
3/16"	.138"	.025"	250	100'	1094P5500	1094P5501	---
1/4"	.170"	.040"	300	100'	1094P5600	1094P5601	1094P5604
5/16"	.233"	.040"	250	100'	1094P0800	1094P0801	1094P0804
3/8"	.275"	.050"	250	100'	1094P6000	1094P6001	1094P6004
1/2"	.375"	.062"	250	100'	1094P6200	1094P6201	1094P6204

## Polyurethane - 95 Durometer Tubing

**Application:**

- good for applications where space is tight; for applications where tubing will be exposed, black tubing is recommended

**Features:**

- high flexibility and a small bend radius
- temperature range: **-40°F to 165°F (-40°C to 74°C)**



Size		Wall Thickness	Working Pressure PSI @ 75°F (24°C)	Length	Clear Polyurethane Part #	Black Polyurethane Part #	Blue Polyurethane Part #
OD	ID						
1/8"	.062"	.031"	233	50'	1091U53R00	1091U5301	1091U5304
5/32"	.093"	.031"	176	50'	1091U04R00	1091U0401	1091U0404
1/4"	.160"	.045"	148	50'	1091U56R00	1091U5601	1091U5604
5/16"	.216"	.049"	148	50'	1091U08R00	1091U0801	1091U0804
3/8"	.250"	.066"	147	50'	1091U60R00	1091U6001	1091U6004
1/2"	.320"	.090"	140	50'	1091U62R00	1091U6201	1091U6204

Size		Wall Thickness	Working Pressure PSI @ 75°F (24°C)	Length	Clear Polyurethane Part #	Black Polyurethane Part #	Blue Polyurethane Part #
OD	ID						
1/8"	.062"	.031"	233	100'	1094U53R00	1094U5301	1094U5304
5/32"	.093"	.031"	176	100'	1094U04R00	1094U0401	1094U0404
1/4"	.160"	.045"	148	100'	1094U56R00	1094U5601	1094U5604
5/16"	.216"	.049"	148	100'	1094U08R00	1094U0801	1094U0804
3/8"	.250"	.066"	147	100'	1094U60R00	1094U6001	1094U6004
1/2"	.320"	.090"	140	100'	1094U62R00	1094U6201	1094U6204

## Fluoropolymer FEP 140 Tubing

**Features:**

- FDA compliant materials
- provides excellent resistance to aggressive and corrosive agents and high temperatures
- maximum temperature: **300°F (149°C)**

Size		Wall Thickness	Working Pressure PSI @ 72°F (22°C)	Length	Clear Fluoropolymer Part #
OD	ID				
1/8"	.062"	.031"	500	25'	1092T5300
1/4"	.170"	.031"	165	25'	1092T5600
3/8"	.300"	.062"	249	25'	1092T6000
1/2"	.420"	.062"	165	25'	1092T6200



Coil-Chief Self-Storing Air Hose

Hose & Tubing



**hose - fittings included**

**Feature:**

- supplied with swivel on one end

Hose ID	Length	Male NPT	Working Pressure @ 70°F (21°C)	Nylon Part #
1/4"	12'	1/4"	185	CC1412
	25'	1/4"	185	CC1425
	50'	1/4"	185	CC1450
3/8"	25'	3/8"	165	CC3825
	50'	3/8"	165	CC3850
1/2"	25'	1/2"	170	CC1225
	50'	1/2"	170	CC1250

**bulk hose - no fittings**

- need assembly kits below for ends



Hose ID	Length	Nylon Part #
1/4"	100'	CC14100B
3/8"	100'	CC38100B
1/2"	100'	CC12100B

**Assembly Kits**

- kit includes: fittings, nut, insert, ferrule and spring guard



RK110 assembly kit

Size	Fitting Type	Part #
1/4"	rigid male	RK090
1/4"	swivel male	RK092
3/8"	rigid male	RK110
3/8"	swivel male	RK112
1/2"	rigid male	RK118
1/2"	swivel male	RK119

**Polyurethane Self-Storing Air Hose  
(fittings included)**

**Features:**

- extremely flexible - resists kinking
- impervious to abrasions, heat and oil
- superior elasticity and coil memory
- both ends swivel

Hose ID	Length	Male NPT	Working Pressure (PSI)	Polyurethane Part #
1/4"	10'	1/4"	145	PU1410
	15'	1/4"	145	PU1415
	25'	1/4"	145	PU1425
3/8"	15'	3/8"	135	PU3815
	20'	3/8"	135	PU3820
	25'	3/8"	135	PU3825
	50'	3/8"	135	PU3850
1/2"	15'	1/2"	155	PU1215



Hose & Tubing

**Repair Kits**

Size	Tubing Size		Type	Brass Part #
	ID	OD		
1/4"	1/4"	3/8"	swivel male	PSM0404
	3/8"	9/16"	swivel male	PSM0604



**Polyurethane Air Hose  
(fittings included)**

**Features:**

- durable and lightweight
- nylon-reinforced braid allows for higher working pressure
- excellent flexibility
- oil resistant
- durometer: Shore A 85
- temperature range: -40°F to 155°F (-40°C to 68°C)
- working pressure: 210 PSI at 70°F (21°C)

Hose ID	Length	Male NPT	Polyurethane Part #
1/4"	50'	1/4"	450-4S
3/8"	50'	1/4"	650-4S
	50'	3/8"	650-6S



## PVC Tubing and Hose Cutters

Hose &amp; Tubing

**Features:**

- rugged construction cuts up to ¾" tubing or hose
- corrosion resistant hardened steel blade ensures straight, crisp cuts for optimum fit

Part #

**TC97****TC97RB****Features:**

- cuts low pressure fabric reinforced hose up to 1" OD
- reversible blade

Part #

**HC90****HC90RB** (replacement blade)**Features:**

- cuts hose and tubing up to 1 7/8" OD
- tough fiberglass reinforced handle
- stainless steel blade

Part #

**LHC95****LHC95RB** (replacement blade)

## Nominal

**Application:**

- suitable for conveying chemicals, foods, pharmaceuticals, oils, gas, fuels and steam

**Features:**

- nominal standard smooth bore PTFE hose meets SAE100R14
- size range: dash-3 to dash-20
- temperature range: **-100°F to 450°F (-73°C to 232°C)**
- 304 stainless braided
- extruded or heat shrink coverings are available upon request
- boxed coils (bulk, per ft. lengths and full reels available from Maryland and Texas call Dixon® at 888.226.4673)
- for use with PTFE fittings on the following page

**Nominal Smooth Bore PTFE Hose  
(fittings not included)**



Nominal Size	Average ID	Length in Feet	Dash Size	Working Pressure	Burst Pressure	White, non-conductive Part #	Black, conductive Part #
3/16"	.125"	100'	dash-3	<b>3000 PSI</b>	12000	---	<b>BSB-03-100</b>
1/4"	.187"	100'	dash-4	<b>3000 PSI</b>	12000	<b>WSB-04-100</b>	<b>BSB-04-100</b>
5/16"	.250"	100'	dash-5	<b>3000 PSI</b>	12000	<b>WSB-05-100</b>	<b>BSB-05-100</b>
3/8"	.312"	100'	dash-6	<b>2500 PSI</b>	10000	<b>WSB-06-100</b>	<b>BSB-06-100</b>
3/8T"	.375"	100'	dash-6T	<b>2250 PSI</b>	9000	<b>WSB-06T-100</b>	<b>BSB-06T-100</b>
1/2"	.405"	100'	dash-8	<b>2000 PSI</b>	8000	<b>WSB-08-100</b>	<b>BSB-08-100</b>
5/8"	.500"	100'	dash-10	<b>1750 PSI</b>	7000	<b>WSB-10-100</b>	<b>BSB-10-100</b>
3/4"	.625"	100'	dash-12	<b>1500 PSI</b>	6000	<b>WSB-12-100</b>	<b>BSB-12-100</b>
3/4T"	.750"	50'	dash-12T	<b>1100 PSI</b>	4400	<b>WSB-12T-50</b>	<b>BSB-12T-50</b>
1"	.875"	50'	dash-16	<b>1000 PSI</b>	4000	<b>WSB-16-50</b>	<b>BSB-16-50</b>

**Nominal Smooth Bore PTFE Hose Per Foot Length  
(fittings not included)**

Nominal Size	Average ID	Dash Size	White, non-conductive Part #	Black, conductive Part #
3/16"	.125"	dash-3	<b>WSB-03</b>	<b>BSB-03</b>
1/4"	.187"	dash-4	<b>WSB-04</b>	<b>BSB-04</b>
5/16"	.250"	dash-5	<b>WSB-05</b>	<b>BSB-05</b>
3/8"	.312"	dash-6	<b>WSB-06</b>	<b>BSB-06</b>
3/8T"	.375"	dash-6T	<b>WSB-06T</b>	<b>BSB-06T</b>
1/2"	.405"	dash-8	<b>WSB-08</b>	<b>BSB-08</b>
5/8"	.500"	dash-10	<b>WSB-10</b>	<b>BSB-10</b>
3/4"	.625"	dash-12	<b>WSB-12</b>	<b>BSB-12</b>
3/4T"	.750"	dash-12T	<b>WSB-12T</b>	<b>BSB-12T</b>
1"	.875"	dash-16	<b>WSB-16</b>	<b>BSB-16</b>
1T"	1.000"	dash-16T	<b>WSB-16T</b>	<b>BSB-16T</b>
1-1/4"	1.125"	dash-20Z	<b>WSB-20Z<sup>1</sup></b>	<b>BSB-20Z<sup>1</sup></b>

<sup>1</sup> double braided

- per feet lengths are available from Maryland and Texas only, call Dixon® at 888.226.4673

Nominal Fittings

Crimp Collars for all nominal fittings are included

- for use with PTFE hoses on the previous pages

Hose & Tubing



Female JIC Swivels

Hose Size	Thread Size	Carbon Steel Part #	304 Stainless Steel Part #	Brass Part #
dash 4	¼"	<i>FJC-04-04</i>	<i>FJS-04-04</i>	<i>FJB-04-04</i>
dash 5	5/16"	<i>FJC-05-05</i>	<i>FJS-05-05</i>	<i>FJB-05-05</i>
dash 6	¾"	<i>FJC-06-06</i>	<i>FJS-06-06</i>	<i>FJB-06-06</i>
dash 8	½"	<i>FJC-08-08</i>	<i>FJS-08-08</i>	<i>FJB-08-08</i>
dash 10	⅝"	<i>FJC-10-10</i>	<i>FJS-10-10</i>	<i>FJB-10-10</i>
dash 12	¾"	<i>FJC-12-12</i>	<i>FJS-12-12</i>	<i>FJB-12-12</i>
dash 16	1"	<i>FJC-16-16</i>	<i>FJS-16-16</i>	<i>FJB-16-16</i>
dash 20Z	1¼"	<i>FJC-20Z-20</i>	<i>FJS-20Z-20</i>	<i>FJB-20Z-20</i>

Rigid Male Pipe Fittings

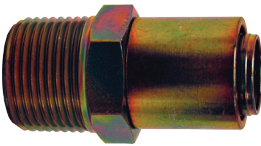

Hose Size	Thread Size	Carbon Steel Part #	304 Stainless Steel Part #	Brass Part #
dash 4	⅛"	<i>MPC-04-02</i>	<i>MPS-04-02</i>	<i>MPB-04-02</i>
dash 4	¼"	<i>MPC-04-04</i>	<i>MPS-04-04</i>	<i>MPB-04-04</i>
dash 5	¼"	<i>MPC-05-04</i>	<i>MPS-05-04</i>	<i>MPB-05-04</i>
dash 6	¼"	<i>MPC-06-04</i>	<i>MPS-06-04</i>	<i>MPB-06-04</i>
dash 6	⅜"	<i>MPC-06-06</i>	<i>MPS-06-06</i>	<i>MPB-06-06</i>
dash 8	⅜"	<i>MPC-08-06</i>	<i>MPS-08-06</i>	<i>MPB-08-06</i>
dash 8	½"	<i>MPC-08-08</i>	<i>MPS-08-08</i>	<i>MPB-08-08</i>
dash 10	½"	<i>MPC-10-08</i>	<i>MPS-10-08</i>	<i>MPB-10-08</i>
dash 12	¾"	<i>MPC-12-12</i>	<i>MPS-12-12</i>	<i>MPB-12-12</i>
dash 16	1"	<i>MPC-16-16</i>	<i>MPS-16-16</i>	<i>MPB-16-16</i>
dash 20Z	1¼"	<i>MPC-20Z-20</i>	<i>MPS-20Z-20</i>	<i>MPB-20Z-20</i>

Female SAE Swivels

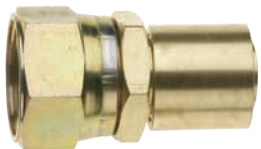

Hose Size	Thread Size	Carbon Steel Part #	Brass Part #
dash 6	⅜"	<i>SAEC-06-06</i>	<i>SAEB-06-06</i>
dash 12	¾"	<i>SAEC-12-12</i>	<i>SAEB-12-12</i>

Nominal PTFE Hose Insertion Tool and Dies

Feature:

- takes the hassle out of installing crimp collars onto braided PTFE Hose; with a few simple steps even challenging braid can be easily and safely inserted into the crimp collar



Size	Description	Part #
---	tool / die holder	<i>ITDH</i>
dash 4	die	<i>ITD-04</i>
dash 5	die	<i>ITD-05</i>
dash 6	die	<i>ITD-06</i>
dash 8	die	<i>ITD-08</i>
dash 10	die	<i>ITD-10</i>
dash 12	die	<i>ITD-12</i>
dash 16	die	<i>ITD-16</i>



## Nominal PTFE Hose Insertion Tool and Dies

**Feature:**

- takes the hassle out of installing crimp collars onto braided PTFE Hose; with a few simple steps even challenging braid can be easily and safely inserted into the crimp collar

Description	Size	Part #
tool / die holder	---	<b>ITDH</b>
die	dash 4	<b>ITD-04</b>
die	dash 5	<b>ITD-05</b>
die	dash 6	<b>ITD-06</b>
die	dash 8	<b>ITD-08</b>
die	dash 10	<b>ITD-10</b>
die	dash 12	<b>ITD-12</b>
die	dash 16	<b>ITD-16</b>



Hose &amp; Tubing

## Nominal Smooth Bore PTFE Hose Fittings

Crimp Collars for all nominal fittings are included

- for use with PTFE hoses on pages 893 - 896

## Tube End Stubs

Hose Size	Tube Size	304 Stainless Steel Part #
dash 4	¼"	<b>TES-04-04</b>
dash 6	⅜"	<b>TES-06-06</b>
dash 8	½"	<b>TES-08-08</b>
dash 12	¾"	<b>TES-12-12</b>
dash 16	1"	<b>TES-16-16</b>



## 45° FJIC Fittings

Hose Size	Thread Size	304 Stainless Steel Part #	Carbon Steel Part #
dash 3	3/16"	<b>FJS45-03-03</b>	<b>FJC45-03-03</b>
dash 4	¼"	<b>FJS45-04-04</b>	<b>FJC45-04-04</b>
dash 5	5/16"	<b>FJS45-05-05</b>	<b>FJC45-05-05</b>
dash 6	⅜"	<b>FJS45-06-06</b>	<b>FJC45-06-06</b>
dash 8	½"	<b>FJS45-08-08</b>	<b>FJC45-08-08</b>
dash 10	⅝"	<b>FJS45-10-10</b>	<b>FJC45-10-10</b>
dash 12	¾"	<b>FJS45-12-12</b>	<b>FJC45-12-12</b>
dash 16	1"	<b>FJS45-16-16</b>	<b>FJC45-16-16</b>
dash 20Z	1¼"	<b>FJS45-20Z-20</b>	<b>FJC45-20Z-20</b>



## 90° FJIC Fittings

Hose Size	Thread Size	304 Stainless Steel Part #	Carbon Steel Part #
dash 3	3/16"	<b>FJS90-03-03</b>	<b>FJC90-03-03</b>
dash 4	¼"	<b>FJS90-04-04</b>	<b>FJC90-04-04</b>
dash 5	5/16"	<b>FJS90-05-05</b>	<b>FJC90-05-05</b>
dash 6	⅜"	<b>FJS90-06-06</b>	<b>FJC90-06-06</b>
dash 8	½"	<b>FJS90-08-08</b>	<b>FJC90-08-08</b>
dash 10	⅝"	<b>FJS90-10-10</b>	<b>FJC90-10-10</b>
dash 12	¾"	<b>FJS90-12-12</b>	<b>FJC90-12-12</b>
dash 16	1"	<b>FJS90-16-16</b>	<b>FJC90-16-16</b>
dash 20Z	1¼"	<b>FJS90-20Z-20</b>	<b>FJC90-20Z-20</b>



N

True ID Hose

Hose & Tubing



(WOC)  
PTFE convoluted  
non-conductive

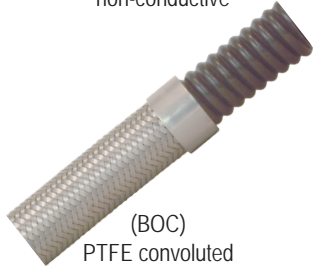

(BOC)  
PTFE convoluted  
conductive



(WTB)  
PTFE smooth bore  
non-conductive

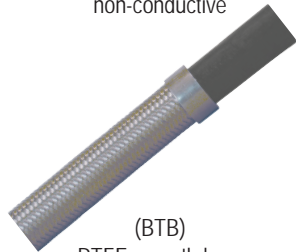

(BTB)  
PTFE smooth bore  
conductive

**Application:**

- suitable for conveying acids, chemicals, foods and pharmaceuticals

**Features:**

- size range: ¼" to 2"
- temperature range: -100°F to 450°F (-73°C to 232°C)
- boxed coils (bulk, per ft. lengths and full reels available from Maryland and Texas, call Dixon® at 888.226.4673)
- 304 stainless braided
- other braids including synthetic, extruded and heat shrink coverings are available upon request
- for use with PTFE fittings on pages 894 - 895

**True ID Open Pitch Convoluted Hose**

(fittings not included)

Size	Working Pressure PSI	Burst Pressure PSI	White, non-conductive Part #	Black, conductive Part #
¼"	1740	6960	WOC-T04	BOC-T04
⅜"	1850	7400	WOC-T06	BOC-T06
½"	1500	6000	WOC-T08	BOC-T08
¾"	1300	5200	WOC-T12	BOC-T12
1"	1000	4000	WOC-T16	BOC-T16
1¼"	900	3600	WOC-T20	BOC-T20
1½"	700	2800	WOC-T24	BOC-T24
2"	500	2000	WOC-T32	BOC-T32

**Heavy Wall True ID Smooth Bore Hose**

(fittings not included)

Size	Working Pressure PSI	Burst Pressure PSI	White, non-conductive Part #	Black, conductive Part #
¼"	3000	12000	WTB-T04	BTB-T04
⅜"	2250	9000	WTB-T06	BTB-T06
½"	1500	6000	WTB-T08	BTB-T08
¾"	1100	4400	WTB-T12	BTB-T12
1"	900	3600	WTB-T16	BTB-T16
1"	1650	6600	WTB-T16Z	BTB-T16Z
1¼"	1000	4000	WTB-T20Z	BTB-T20Z
1½"	1100	4000	WTB-T24Z	BTB-T24Z

True ID Fittings

Crimp collars for all True ID fittings are sold separately

**Female JIC Swivels**



Size	Carbon Steel Part #	316 Stainless Steel Part #
¼"	FJC-T04	FJR-T04
⅜"	FJC-T06	FJR-T06
½"	FJC-T08	FJR-T08
¾"	FJC-T12	FJR-T12
1"	FJC-T16	FJR-T16
1¼"	FJC-T20	FJR-T20
1½"	FJC-T24	FJR-T24
2"	FJC-T32	FJR-T32

**Rigid Male Pipe Fittings**



Size	Carbon Steel Part #	316 Stainless Steel Part #
¼"	MPC-T04	MPR-T04
⅜"	MPC-T06	MPR-T06
½"	MPC-T08	MPR-T08
¾"	MPC-T12	MPR-T12
1"	MPC-T16	MPR-T16
1¼"	MPC-T20	MPR-T20
1½"	MPC-T24	MPR-T24
2"	MPC-T32	MPR-T32

## True ID Fittings

## PTFE Hose Fittings

- for use with PTFE hoses on pages 893 - 896

## Sanitary Tri-Clamps

Hose Size	Clamp Size	316 Stainless Steel Part #
½"	1"	<b>TCR-T08-16</b>
½"	1½"	<b>TCR-T08-24</b>
¾"	1½"	<b>TCR-T12-24</b>
1"	1"	<b>TCR-T16-16</b>
1"	1½"	<b>TCR-T16-24</b>
1½"	1½"	<b>TCR-T24-24</b>
2"	2"	<b>TCR-T32-32</b>



## Mini Sanitary Tri-Clamps

Size	316 Stainless Steel Part #
½"	<b>TCMR-T08</b>
¾"	<b>TCMR-T12</b>



- contact Dixon® at 888.226.4673 for GSM and PTFE hose assemblies

## Flange Retainers

## Feature:

- for use with lap joint flanges, see pages 688 - 689

Size	316 Stainless Steel Part #	316 Stainless Steel PTFE Encapsulated Part #
½"	<b>FRR-T08</b>	---
¾"	<b>FRR-T12</b>	<b>FRRE-T12</b>
1"	<b>FRR-T16</b>	<b>FRRE-T16</b>
1¼"	<b>FRR-T20</b>	<b>FRRE-T20</b>
1½"	<b>FRR-T24</b>	<b>FRRE-T24</b>
2"	<b>FRR-T32</b>	<b>FRRE-T32</b>

Crimp Collars  
Convuluted Crimp Collar

## Features:

- for open pitch convuluted PTFE hose only
- new design for ease of installation and improved appearance of finished crimp

Size	Carbon Steel Part #	304 Stainless Steel Part #
¼"	<b>CSC-T04-1</b>	<b>SSC-T04-1</b>
⅜"	<b>CSC-T06-1</b>	<b>SSC-T06-1</b>
½"	<b>CSC-T08-1</b>	<b>SSC-T08-1</b>
¾"	<b>CSC-T12-1</b>	<b>SSC-T12-1</b>
1"	<b>CSC-T16-1</b>	<b>SSC-T16-1</b>
1¼"	<b>CSC-T20-1</b>	<b>SSC-T20-1</b>
1½"	<b>CSC-T24-1</b>	<b>SSC-T24-1</b>
2"	<b>CSC-T32-1</b>	<b>SSC-T32-1</b>



## Features:

## Smooth Bore Crimp Collars

- for True ID smooth bore PTFE hose only
- new design for ease of installation and improved appearance of finished crimp

Size	Carbon Steel Part #	304 Stainless Steel Part #
¼"	<b>CSC-T04-2</b>	<b>SSC-T04-2</b>
⅜"	<b>CSC-T06-2</b>	<b>SSC-T06-2</b>
½"	<b>CSC-T08-2</b>	<b>SSC-T08-2</b>
¾"	<b>CSC-T12-2</b>	<b>SSC-T12-2</b>
1"	<b>CSC-T16-2</b>	<b>SSC-T16-2</b>
1¼"	<b>CSC-T20-2</b>	<b>SSC-T20-2</b>
1½"	<b>CSC-T24-2</b>	<b>SSC-T24-2</b>



Contact Dixon® at 888.226.4673 for assembly instructions and crimp recommendations.

## Spiral Hose and Cable Protection

**Application:**

- used in mining, quarrying, forestry, offshore industries and most hydraulic hose applications

**Features:**

- crush and high abrasion resistance
- chemical and UV ray resistant
- self-lubricating to reduce hose wear
- easy to install on-site
- smooth radius on all edges
- can be used on single or multiple hose bundles
- spiral guard ID is equal to the guard at rest
- sold in coil lengths only



**Flame Retardant Product**

**Features:**

- approved by MSHA #1C-264/0
- tested to: AS 2600, AS1180.10B, AS 1180.13A
- flame retardant, self extinguishing, anti static
- temperature range: **-148°F to 262°F (-100°C to 128°C)**
- color: black

Nominal ID	Coil Length	OD Range (inches)	Part #
0.45"	66'	.47" to .86"	<i>FRSGX16</i>
0.55"	66'	.62" to 1.06"	<i>FRSGX20</i>
0.80"	66'	.86" to 1.37"	<i>FRSGX25</i>
1.00"	66'	1.06" to 1.69"	<i>FRSGX32</i>
1.26"	66'	1.30" to 2.17"	<i>FRSGX40</i>
1.50"	66'	1.65" to 2.52"	<i>FRSGX50</i>
2.00"	66'	2.05" to 2.95"	<i>FRSGX63</i>
2.40"	66'	2.56" to 3.80"	<i>FRSGX75</i>
2.83"	66'	3.15" to 4.30"	<i>FRSGX90</i>
3.43"	33'	3.80" to 4.90"	<i>FRSGX110</i>

**Standard Product**

**Features:**

- not flame retardant
- temperature range: **-40°F to 248°F (-40°C to 120°C)**



Nominal ID	Coil Length	OD Range (inches)	Part #
0.45"	66'	.47" to .86"	<i>NFSGX16</i>
0.55"	66'	.62" to 1.06"	<i>NFSGX20</i>
0.80"	66'	.86" to 1.37"	<i>NFSGX25</i>
1.00"	66'	1.06" to 1.69"	<i>NFSGX32</i>
1.26"	66'	1.30" to 2.17"	<i>NFSGX40</i>
1.50"	66'	1.65" to 2.52"	<i>NFSGX50</i>
2.00"	66'	2.05" to 2.95"	<i>NFSGX63</i>
2.40"	66'	2.56" to 3.80"	<i>NFSGX75</i>
2.83"	66'	3.15" to 4.30"	<i>NFSGX90</i>
3.43"	33'	3.80" to 4.90"	<i>NFSGX110</i>
4.48"	40'	4.50" to 5.50"	<i>NFSGX125</i>
5.07"	27'	<b>NEW</b> 4.80" to 6.00"	<i>NFSGX140</i>
5.87"	20'	5.70" to 7.00"	<i>NFSGX160</i>

## Fiberglass Sleeving

**Features:**

- thermal insulation protection in applications with service temperatures up to **1000°F (538°C)**
- supplied in a continuous length of 100'
- 1/16" wall thickness
- braided from texturized E-glass filament yarns, untreated tubing is flexible and expands to cover changing diameters
- Made in USA

Nominal ID	Fiberglass Part #
1/4"	LW04200
3/8"	LW06200
1/2"	LW08200
5/8"	LW10200
3/4"	LW12200
7/8"	LW14200
1"	LW16200
1 1/4"	LW20200
1 1/2"	LW24200
2"	LW32200
2 1/2"	LW40200
3"	LW48200
3 1/2"	LW56200
4"	LW64200



Hose & Tubing

## Kevlar® Protective Sleeves

**Features:**

- braided cut-resistant 100% genuine Kevlar® fiber sleeve provides excellent flexibility
- provides protection for hydraulic hoses full lines, wires, cables and many other systems
- working temperature: continuous **320°F (160°C)**, short term **570°F (300°C)**
- 3000 denier ballistic grade Kevlar®; nonirritating fiber
- Made in USA

Sleeve ID	100' spool Part #
1/2" (13 mm)	KS08200
3/4" (19 mm)	KS12200
1" (25 mm)	KS16200
1 1/4" (32 mm)	KS20200
1 1/2" (38 mm)	KS24200
1 3/4" (44 mm)	KS28200
2" (51 mm)	KS32200
2 1/2" (64 mm)	KS40200
3" (76 mm)	KS48200
3 1/2" (89 mm)	KS56200
4" (102 mm)	KS64200



## Nylon Protective Sleeves - MSHA Accepted

**Features:**

- woven tubular sleeving, for use as a protective covering on hydraulic and industrial hose
- tight weave of seamless tubular sleeving helps dispense the flow of fluid in a ruptured hose
- MSHA accepted, withstands temperatures up to **275°F (135°C)**, passes flammability tests
- not continuous rolls/has splices

Nominal ID	Outside Flat	100' rolls Part #	300' rolls Part #
0.90"	1.50"	DHS90-100	DHS90-300
1.00"	1.66"	DHS100-100	DHS100-300
1.13"	1.88"	DHS106-100	DHS106-300
1.25"	2.13"	DHS122-100	DHS122-300
1.46"	2.25"	DHS138-100	DHS138-300
1.42"	2.50"	DHS142-100	DHS142-300
1.58"	2.75"	DHS159-1-100	DHS159-1-300
1.78"	2.88"	DHS175-100	DHS175-300
1.91"	3.00"	DHS181-100	DHS181-300
2.18"	3.63"	DHS219-100	DHS219-300
2.38"	3.88"	DHS238-100	DHS238-300
2.65"	4.25"	DHS263-100	DHS263-300
2.86"	4.75"	DHS288-100	DHS288-300
3.65"	5.88"	DHS366-100	DHS366-300

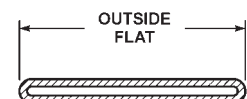
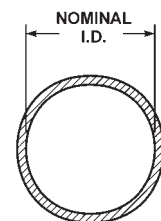

## Spring Guard

**Features:**

- protects hose against the effects of flexing at its most vulnerable point - immediately behind the coupling
- optional end tang allows end guard to be secured under a clamp or ferrule
- wire fits most hose OD's from ½" to 3¼", contact Dixon® for custom sizes or lengths

Hose & Tubing



**with tang**

Guard ID	Wire Gauge	Overall Length	Tang Length	Approx. # of Coils/Ft.	Galvanized Steel Part #	304 Stainless Steel Part #
¾"	0.175	12"	1"	33	<b>SEGC1-0.75-12</b>	<b>SEGS1-0.75-12</b>
1"	0.175	12"	1"	33	<b>SEGC1-1.00-12</b>	<b>SEGS1-1.00-12</b>
1¼"	0.175	14"	2"	39	<b>SEGC1-1.25-14</b>	<b>SEGS1-1.25-14</b>
1½"	0.175	14"	2"	39	<b>SEGC1-1.50-14</b>	<b>SEGS1-1.50-14</b>
1¾"	0.175	16"	2"	44	<b>SEGC1-1.75-16</b>	<b>SEGS1-1.75-16</b>
2"	0.280	16"	2"	44	<b>SEGC1-2.00-16</b>	<b>SEGS1-2.00-16</b>
2½"	0.280	18"	2"	50	<b>SEGC1-2.50-18</b>	<b>SEGS1-2.50-18</b>
3"	0.280	18"	2"	50	<b>SEGC1-3.00-18</b>	<b>SEGS1-3.00-18</b>

**without tang**

Guard ID	Wire Gauge	Overall Length	Tang Length	Approx. # of Coils/Ft.	Galvanized Steel Part #	304 Stainless Steel Part #
¾"	0.175	12"	1"	33	<b>SEGC0-0.75-12</b>	<b>SEGS0-0.75-12</b>
1"	0.175	12"	1"	33	<b>SEGC0-1.00-12</b>	<b>SEGS0-1.00-12</b>
1¼"	0.175	14"	2"	39	<b>SEGC0-1.25-14</b>	<b>SEGS0-1.25-14</b>
1½"	0.175	14"	2"	39	<b>SEGC0-1.50-14</b>	<b>SEGS0-1.50-14</b>
1¾"	0.175	16"	2"	44	<b>SEGC0-1.75-16</b>	<b>SEGS0-1.75-16</b>
2"	0.280	16"	2"	44	<b>SEGC0-2.00-16</b>	<b>SEGS0-2.00-16</b>
2½"	0.280	18"	2"	50	<b>SEGC0-2.50-18</b>	<b>SEGS0-2.50-18</b>
3"	0.280	18"	2"	50	<b>SEGC0-3.00-18</b>	<b>SEGS0-3.00-18</b>



## Continuous Spring Guard

**Features:**

- protects hose from external abrasion and helps resist over flexing
- fits tight to hose reducing the potential for snagging
- contact Dixon® at 888.226.4673 for custom lengths or sizes



Guard ID	Wire Gauge	Overall Length	Approx. # of Coils/Ft.	Galvanized Steel Part #	304 Stainless Steel Part #
¾"	0.175"	25'	33'	<b>CWG-C-0.75-25</b>	<b>CWG-S-0.75-25</b>
1"	0.175"	25'	33'	<b>CWG-C-1.00-25</b>	<b>CWG-S-1.00-25</b>
1¼"	0.175"	25'	33'	<b>CWG-C-1.25-25</b>	<b>CWG-S-1.25-25</b>
1½"	0.175"	25'	33'	<b>CWG-C-1.50-25</b>	<b>CWG-S-1.50-25</b>
1¾"	0.175"	25'	33'	<b>CWG-C-1.75-25</b>	<b>CWG-S-1.75-25</b>
2"	0.280"	25'	33'	<b>CWG-C-2.00-25</b>	<b>CWG-S-2.00-25</b>
2½"	0.280"	25'	33'	<b>CWG-C-2.50-25</b>	<b>CWG-S-2.50-25</b>
3"	0.280"	25'	33'	<b>CWG-C-3.00-25</b>	<b>CWG-S-3.00-25</b>



## GSM Ball-Joint Armored Hose Assemblies

inner hoses are specially industrial rubber, hydraulic, corrugated stainless steel or PTFE

multiple layers of 1000°F fiberglass insulation provide extreme heat resistance

no interlocking parts to restrict bending

ball-joint armor protects against extreme heat, molten splash, abrasion and kinking



**Application:**

- includes but not limited to: water cooling hose, oxygen supply hose, hydraulic hose, natural gas hose, black liquor hose, steam hose

**Sizes:**

- ¼" through 16" bore
- lengths to 120'

**Materials:**

- armor: galvanized steel or stainless steel
- wide selection of inner hoses specific to the demands of the application are industrial, hydraulic, stainless steel or PTFE

**Features:**

- extremely flexible armor protects from heat, slag splash and harsh environments
- heat resistant insulation to 1000°F
- temperature rating depends on specific applications, consult Dixon®
- a variety of end connections are available, contact Dixon® at 888.226.4673

## Thread Tape & Sealant..... 902 to 903

PTFE tape .....	902
American made (purple) .....	902
Industrial (white).....	902
Stainless steel (gray) .....	902
Industrial heavy duty (pink).....	902
For LP gas (yellow) .....	902
Thread sealant paste.....	903
Joint sealant gasket material.....	903
Leak detector.....	903

## Coupling Inserters ..... 904

Coupling inserter for large hose .....	904
Coupling inserter for 5 ton ram.....	904

## Testing Equipment ..... 905 to 907

Hand hydrotest pump .....	905
Hydrostatic test pumps.....	905
Hydrostatic test pump accessories.....	906
Sprinkler system gauges (UM-393).....	907
Line test gauges .....	907
Three way gauge valve .....	907
PITOT gauge .....	907
Sprinkler line tester.....	907

## Accessories ..... 908 to 911

Dixon® coupling lubricant .....	908
WD-40 smart straw .....	908
Spill kits .....	908
Dixon® soft hose mallet.....	909
Dixon® hose knife .....	909
Diameter tape .....	909
Screw pitch gauge .....	909
Bottle opener.....	910
Safety tag .....	910
Safety tape .....	910
Stretch straps .....	911
Pick head fire axe .....	911

## Grease Whip Fittings ..... 912 to 913

Grease whip hose assemblies.....	912
Grease whip hose fittings.....	912
Grease whip fittings - Zerk.....	913

## Oxy-Acetylene Fittings ..... 914

Oxy-acetylene hose couplings.....	914
Oxy-acetylene connecting spuds.....	914
Oxy-acetylene adapters.....	914
Oxy-acetylene ferrules.....	914

### American Made PTFE Tape (Purple)

**Features:**

- thickness: 3.5 mil (0.0035 mm)
- temperature range: **-450°F to 500°F (-268°C to 260°C)**
- superior quality
- not for use in oxygen applications 



Size	Length	Part #
1/2"	520"	<b>TTPM50-520</b>
	700"	<b>TTPM50-700</b>
	1429"	<b>TTPM50-1429</b>
3/4"	520"	<b>TTPM75-520</b>
	700"	<b>TTPM75-700</b>
	1429"	<b>TTPM75-1429</b>
1"	520"	<b>TTPM100-520</b>
	700"	<b>TTPM100-700</b>
	1429"	<b>TTPM100-1429</b>

### Industrial PTFE Tape (White)

**Features:**

- thickness: 3.5 mil (0.0035 mm)
- temperature range: **-212°F to 500°F (-136°C to 260°C)**



Size	Length	Part #	Optional Qty
1/2"	260"	<b>TTA50</b>	550
	520"	<b>TTB50</b>	500
	1296"	<b>TTC50</b>	250
3/4"	260"	<b>TTA75</b>	350
	520"	<b>TTB75</b>	350
1"	520"	<b>TTB100</b>	250

### Stainless Steel PTFE Tape (Gray)

**Features:**

- thickness: 4 mil
- temperature range: **-450°F to 550°F (-268°C to 288°C)**
- useful on stainless steel threaded joints or connections
- PTFE with nickel added, nickel acts like a ball bearing
- made in the US



Size	Length	Part #	Optional Qty
1/2"	260"	<b>TTA50SS</b>	10

### Industrial Heavy Duty PTFE Tape (Pink)

**Features:**

- thickness: 4 mil
- temperature range: **-400°F to 500°F (-240°C to 260°C)**



Size	Length	Part #	Optional Qty
1/2"	540"	<b>TTBP50</b>	500

### PTFE Tape for LP Gas (Yellow)

**Features:**

- thickness: 4 mil
- maximum temperature: **500°F (260°C)**
- Underwriters Listed 

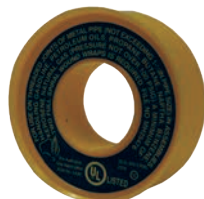

Size	Length	Part #	Optional Qty
1/2"	260"	<b>TTA50LP</b>	500





Thread Sealant Paste

Features:

- temperature range: **-300°F to 500°F (-184°C to 260°C)**
- do not use with oxygen

Size	Part #	Optional Qty
¼ pint	<b>LCTS14</b>	24
½ pint	<b>LCTS1</b>	24
1 pint	<b>LCTS2</b>	12
1 quart	<b>LCTS3</b>	12



Joint Sealant Gasket Material

Features:

- GORE-TEX® interchangeable
- Form-In-Place expanded PTFE gasket material with adhesive backing
- manufactured from 100% virgin PTFE
- unaffected by all common chemicals (pH from 0-14)
- unlimited shelf life
- resilient with low cold flow
- requires less force than standard gasket materials
- pressure range: **vacuum to 3000 PSI**
- temperature range: **-450°F to 600°F (-268°C to 316°C)**
- made in the USA
- FDA compliant #21CFR177.1550
- larger spools are available, consult Dixon® for price and availability

Size	Length	Part #
¼"	20'	<b>LCJS4-20</b>
¼"	50'	<b>LCJS4-50</b>
⅜"	25'	<b>LCJS6-25</b>
½"	15'	<b>LCJS8-15</b>
¾"	15'	<b>LCJS12-15</b>



Leak Detector

Features:

- detects leaks by forming bubbles which remain for up to ten minutes
- will not cause corrosion or deterioration
- color: fluorescent yellow
- non-toxic, non-freezing
- temperature range: **-7°F to 180°F (-20°C to 82°C)**
- meets Federal specification MIL-L-25567-C

Size	Part #	Case Qty
8 oz.	<b>LCLD</b>	24



Coupling Inserter for Large Hose

Features:

- inserts 4", 5", 6", 8", 10" and 12" couplings
- includes CI96AH pump (shown below)
- portable
- coupling inserter pusher plates (not shown) must be purchased separately



Part #	
<b>CI9</b>	
Hose ID	Part #
4" - 5"	<b>45CI9PUSH</b>
6" - 8"	<b>68CI9PUSH</b>
10" - 12"	<b>1012CI9PUSH</b>

Coupling Inserters



CI96

Application:

- for insertion of hose shanks into hose with a 2¾" to 7¼" OD



CI96AH

Description	Part #
inserter with <b>10,000 PSI</b> hand pump and 5 ton ram	<b>CI96</b>
inserter with <b>10,000 PSI</b> air/hydraulic pump and 5 ton ram	<b>CI96AH</b>
small jaws for 1" to 3" OD hose	<b>CI9311SML</b>

## Hand Hydrotest Pump

**Application:**

- designed for use in testing pipe lines, pressure tanks and pressure vessels

**Features:**

- uses check valves which are more efficient and longer lasting than poppet systems
- cylinder displacement: 1.37 cu. in.
- **0 -1000 PSI** pressure gauge, 10' high pressure hose and quick disconnect coupler included
- piston: 7/8" with 2" stroke
- stainless steel piston
- working pressure: **1000 PSI at 70°F (21°C)**

NPT Inlet	NPT Outlet	Aluminum
1/2"	1/2"	Part #
		<b>HHTP</b>



## Hydrostatic Test Pumps

### Electric Test Pump

**Features:**

- 110 volt Portable Hydrostatic Electric Pump - Model (ETP)
- 3000 PSI maximum test pressure
- 1.3 GPM fill rate (at 60 PSI inlet water pressure)
- Quick connect garden hose coupler for water supply line available
- 1/2" x 25' intermediate hose with brass Straight-Thru Quick Coupler x NPSM swivel connection
- 1/2" brass Straight-Thru plug on pressure outlet
- 0 – 3000 PSI back mount liquid filled pressure gauge

Part #
<b>ETP</b>



### Pneumatic Test Pump

**Features:**

- 5.5 GPM fill rate
- test pressure: **0 to 1500 PSI**
- stainless interior
- air gauge for quick, easy adjustment of maximum test pressure
- high pressure test gauge
- filter/regulator for clean, dry air to ensure long life of unit
- on - off valve for air input
- 15' of hose included
- easy to use: portable hand cart mount or stationary wall mount available
- use of coalescing filter and water filter recommended for prolonged pump life

Hand Cart Mount	Wall Mount
Part #	Part #
<b>PTP</b>	<b>PTP-WM</b>



Hydrostatic Test Pump Accessories

Features:

- cost effective, pre-assembled caps or plugs allow quick set up for testing hoses
- caps and plugs equipped with 1/2" brass straight-through plug for quick attachment to the intermediate hose on the test pump (Pneumatic Test Pump) and bleed-off valve

Maintenance & Repair

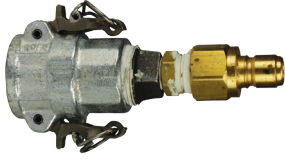

Cam & Groove Test Caps for Male Adapters

Size	Iron / Steel Part #
1"	<b>ID100TC</b>
1½"	<b>ID150TC</b>
2"	<b>ID200TC</b>
3"	<b>ID300TC</b>
4"	<b>ID400TC</b>



Cam & Groove Test Plugs for Female Couplers

Size	Iron / Steel Part #
1"	<b>IA100TP</b>
1½"	<b>IA150TP</b>
2"	<b>IA200TP</b>
3"	<b>IA300TP</b>
4"	<b>IA400TP</b>



Female NPT Test Caps

Size	Iron / Steel Part #
1"	<b>NPT100TC</b>
1½"	<b>NPT150TC</b>
2"	<b>NPT200TC</b>
3"	<b>NPT300TC</b>
4"	<b>NPT400TC</b>



Male NPT Test Plugs

Size	Iron / Steel Part #
1"	<b>100TP</b>
1½"	<b>150TP</b>
2"	<b>200TP</b>
3"	<b>300TP</b>
4"	<b>400TP</b>



Bleed-off Valve

Part #
<b>IBV50BOV</b>



M16-03A

FRL Attachment Accessories

Description	Part #
3/8" Wilkerson modular coalescing filter (automatic drain)	<b>M16-03A</b>
3/8" Wilkerson modular coalescing filter (manual drain)	<b>M16-03M</b>
modular sleeve needed to connect M16-03A or M16-03M	<b>GPA-95-292</b>



### Sprinkler System Gauge (UL-393)



**Features:**

- specifically designed for the fire sprinkler industry
- Bourdon tube pressure gauges with black polycarbonate case
- snap-in clear polycarbonate window, 4" face
- white aluminum dial with stop pin, black and red markings
- black aluminum non-adjustable pointer
- 1/4" NPT lower mount
- ASME B40.1 Grade B (+ 3/2/3% accuracy)
- U/L Listed (U/L-393) and Factory Mutual Approved for fire sprinkler service
- temperature range: **-40°F to 140°F (-40°C to 60°C)**



Maintenance & Repair

Type	Part #
water (0-300 PSI)	<b>SWG300-4</b>

### Line Test Gauges

**Features:**

- rocker lug swivel
- used for testing static or flowing pressures in hoses or nozzles
- supplied with **0-300 PSI** glycerine filled 3 1/2" diameter gauge
- freeze proof to **-40°F (-40°C)**
- other sizes and threads are also available, contact Dixon®



NST (NH) Thread	Hardcoated Aluminum Part #
1 1/2"	<b>ALTG150F</b>
2 1/2"	<b>ALTG250F</b>

### Three Way Gauge Valve

**Features:**

- permits checking or replacing a gauge without shutting down the whole line
- disc: rubber



NPT Thread	Working Pressure (PSI)	Brass Part #
1/4"	<b>175</b>	<b>TWGV25</b>

### PITOT Gauge

**Features:**

- liquid filled gauge 0-160 PSI is standard, other pressures available, contact Dixon®
- supplied with handle grip, case and fire stream/friction loss data



Part #
<b>PG8083</b>

### Sprinkler Line Tester



**Feature:**

- installs on the last sprinkler head on system branch lines and controls water flow for flushing or testing the system



Inlet	Outlet	Brass Part #
1" female NPT	1" male NPSH	<b>SLT10050</b>



## Dixon® Coupling Lubricant

**Application:**

- for use in assembly operations involving natural or synthetic rubber or plastic, also an excellent lubricant when rubber or plastic needs to be cut, machined, pressed, turned, trimmed or ground

**Features:**

- biodegradable lubricant for coupling shanks, O-rings, hoses, sleeves, rubber washers and grommets
- once coupling lubricant dries, slipping action goes away

Size	Part #
1 liter	<b>DCL20</b>
4 liters	<b>DCL80</b>

## WD-40 Smart Straw

**Features:**

- permanently attached straw
- flip up for a precision spray; flip down for regular spray action
- sold in case quantities only
- should not be used as a lubricant for coupling shanks 

Size	Part #	Case Qty
11 oz.	<b>WD40</b>	12

## Spill Kits



oil spill kit



universal spill kit

**Features:**

- easily stored behind a seat or in a storage compartment allowing drivers to act quickly when responding to a spill
- poly-zip bag and bucket kits feature:
  - 10 pads (15" x 19")
  - 3 socks (3" x 4')
  - 2 disposal bags with ties
  - 1 pair nitrile gloves

Description	Part #
oil only, in 6½ gallon pail	<b>DSK5-O</b>
universal, in 6½ gallon pail	<b>DSK5-U</b>
oil only, in clear poly bag with zipper	<b>DSKB-O</b>
universal, in clear poly bag with zipper	<b>DSKB-U</b>



### Dixon® Soft Hose Mallet

**Features:**

- soft mallet for pounding metal objects without damaging them
- head material is firmly attached to strong shaft-handle and will not crack
- length: 23"
- weight: 10 lbs.



Maintenance & Repair

Part #

**DCM1**

### Dixon® Hose Knife

**Features:**

- for fast cutting of rubber hose and belting
- guard protects hand while cutting



Part #

**DRK15**

### Diameter Tape

**Features:**

- 6' tape for quickly finding the outside diameter of any cylindrical object
- converts circumference to OD at the measured point
- ABS case



Part #

**DDT1**

### Screw Pitch Gauge

**Features:**

- used to determine threads per inch
- 30 leaves

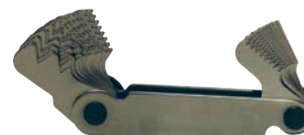

*Stainless Steel*

Part #

**TPG**



Bottle Opener



Brass  
Part #

**CAMOPENER**

Safety Tag

**Features:**

- Dixon® strongly recommends the use of a safety tag or warning label on all hose assemblies.
- sold in quantities of 100 only



Length	Width	Part #
5"	2 <sup>3</sup> / <sub>8</sub> "	<b>DWL100</b>



**WARNING!!**

- worn-out hose fittings should be replaced
- loose clamps on hose can be dangerous
- bolt type clamps should be retensioned regularly
- for extra safety, retaining devices such as clips, chains or cables must be used

Safety Tape

**Features:**

- Dixon® strongly recommends the use of a safety tag or warning label on all hose assemblies.
- length of tape - 55 yards, approximately 255 warnings



Length	Part #
1 <sup>1</sup> / <sub>2</sub> "	<b>DSTW</b>



**WARNING!!**

- worn-out hose fittings should be replaced
- loose clamps on hose can be dangerous
- bolt type clamps should be retensioned regularly
- for extra safety, retaining devices such as clips, chains or cables must be used





## Stretch Straps

**Features:**

- durable tie down straps
- made of EPDM
- length does not include S-hooks
- S-hooks are steel

Length	Part #
10"	<b>SSE10</b>
15"	<b>SSE15</b>
21"	<b>SSE21</b>
31"	<b>SSE31</b>
41"	<b>SSE41</b>



**WARNING!!**

Failure to comply with this warning may result in serious damage and/or personal injury.  
Maximum end to end safe stretch = 150% of length

- do not exceed maximum safe stretch
- inspect before each use, do not use if strap is cut, cracked or abraded
- inspect hooks for damage and/or wear. Replace if needed.
- protect strap from sharp edges or heat.
- wear eye protection during use
- do not use this product as the primary tie down
- refer to federal or state regulations for proper tie down methods



Maintenance  
& Repair

## Pick Head Fire Axe

**Features:**

- red trim
- 36" hickory handle
- listed in the minimum requirements approval guides for outfitting hose houses and hose cabinets by insurance underwriters

Description	Part #
6 lb. axe	<b>PHFA6</b>
axe brackets	<b>PHFA-B-A</b>



Grease Whip Hose Assemblies

Features:

- for use with hand grease guns only
- one piece crimp couplings
- 1/8"-27 male NPT thread, solid base
- US manufactured 3/16" ID hose - exceeds SAE 100R1-AT
- add "S" to order strain relief spring option
- working pressure: **3000 PSI**



Assembly Length	Brass	
	Previous Part #	Part #
8"	GWH-0800	<b>GWH0800</b>
12"	GWH-1200	<b>GWH1200</b>
	---	<b>GWH1200R<sup>1</sup></b>
18"	GWH-1800	<b>GWH1800</b>
	---	<b>GWH1800R<sup>1</sup></b>
24"	GWH-2400	<b>GWH2400</b>
36"	GWH-3600	<b>GWH3600</b>
48"	GWH-4800	<b>GWH4800</b>
60"	GWH-6000	<b>GWH6000</b>

<sup>1</sup> retail packaging

Grease Whip Hose Fittings

Features:

- **001-0055**, **001-0260** and **001-0860** are designed to be crimped to 3/16" ID hose
- **GWH-C** and **GWHC-FF** mate with Zerk fittings on the coupler side

Grease Hose Couplers

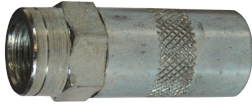

Description	Zinc Plated Steel		Optional Qty
	Previous Part #	Part	
1/8"-27 female NPT thread, grease hose coupler with ball check - valved shutoff	GWH-C	<b>GWHC</b>	25
1/8"-27 female NPT thread, full flow grease hose coupler	---	<b>GWHC-FF</b>	25

Add 'R' suffix to part number for retail pack option

Male NPT Thread - Chamfered Base



Description	Brass		Optional Qty
	Previous Part #	Part #	
1/8"-27 male NPT thread, drilled and chamfered base	001-0055	<b>0010055C</b>	100

Male NPT thread - Solid Base

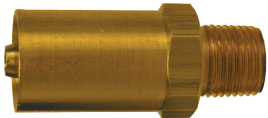

Description	Brass		Optional Qty
	Previous Part #	Part #	
1/8"-27 male NPT thread, solid base	001-0260	<b>0010260C</b>	100

Female NPT Thread

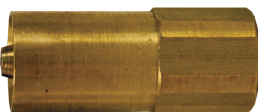

Description	Brass		Optional Qty
	Previous Part #	Part #	
1/8"-27 female NPT thread	001-0860	<b>0010860C</b>	100



Grease Whip Fittings - Zerk

**Straight**

Thread	Description	Overall Length	Thread Length	Hex	Zinc Plated Steel Part #	Pkg Qty
1/8"-27 NPT	straight	.660"	.260"	.430	<b>GWHZ000</b>	100
1/4"-28 tapered SAE-LT	straight	.530"	.200"	.312	<b>GWHZ400</b>	100



Maintenance & Repair

**45°**

Thread	Description	Overall Length	Thread Length	Hex	Zinc Plated Steel Part #	Pkg Qty
1/8"-27 NPT	45°	.860"	.280"	.430	<b>GWHZ045</b>	100
1/4"-28 tapered SAE-LT	45°	.800"	.200"	.375	<b>GWHZ445</b>	100



**90°**

Thread	Description	Overall Length	Thread Length	Hex	Zinc Plated Steel Part #	Pkg Qty
1/8"-27 NPT	90°	.830"	.310"	.430	<b>GWHZ090</b>	100
1/4"-28 tapered SAE-LT	90°	1.20"	.200"	.375	<b>GWHZ490</b>	100



Grease Whip Fittings - Zerk Retail Packaged

All items sold in retail packets of 10: Order 1 for 1 retail pack of 10 pieces.

**Straight**

Thread	Description	Overall Length	Thread Length	Hex	Zinc Plated Steel Part #
1/8"-27 NPT	straight	.660"	.260"	.430	<b>GWHZ000R</b>
1/4"-28 tapered SAE-LT	straight	.530"	.200"	.312	<b>GWHZ400R</b>



**45°**

Thread	Description	Overall Length	Thread Length	Hex	Zinc Plated Steel Part #
1/8"-27 NPT	45°	.860"	.280"	.430	<b>GWHZ045R</b>
1/4"-28 tapered SAE-LT	45°	.800"	.200"	.375	<b>GWHZ445R</b>



**90°**

Thread	Description	Overall Length	Thread Length	Hex	Zinc Plated Steel Part #
1/8"-27 NPT	90°	.830"	.310"	.430	<b>GWHZ090R</b>
1/4"-28 tapered SAE-LT	90°	1.20"	.200"	.375	<b>GWHZ490R</b>



Oxy-Acetylene Hose Couplings

Acetylene Couplings

left-hand thread for acetylene line x hose shank



Hose Size	Left UNF Thread	Hex	Previous Part #	Brass	
				Part #	
3/16"	3/8"-24	7/16"	OA69		1540306K
	9/16"-18	11/16"	OA70		1540309K
1/4"	9/16"-18	11/16"	OA71		1540409K
5/16"	9/16"-18	11/16"	OA72		1540509K
3/8"	9/16"-18	11/16"	OA73		1540609K

Oxygen Couplings

right-hand thread for oxygen line x hose shank



Hose Size	Right UNF Thread	Hex	Previous Part #	Brass	
				Part #	
3/16"	3/8"-24	7/16"	OA59		1520306K
	9/16"-18	11/16"	OA60		1520309K
1/4"	9/16"-18	11/16"	OA61		1520409K
5/16"	9/16"-18	11/16"	OA62		1520509K
3/8"	9/16"-18	11/16"	OA63		1520609K

Oxy-Acetylene Connecting Spuds

Left-hand Thread x Left-hand Thread

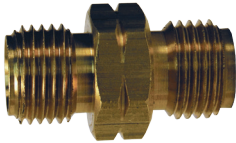

Left UNF Thread	Hex	Previous Part #	Brass	
			Part #	
9/16"-18	11/16"	OA52		1580909C

Right-hand Thread x Right-hand Thread

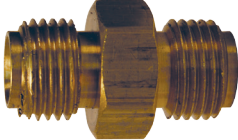

Right UNF Thread	Hex	Previous Part #	Brass	
			Part #	
9/16"-18	11/16"	OA50		1560909C

Oxy-Acetylene Adapters

Left-hand Thread x NPTF



Left UNF Thread	NPTF Thread	Hex	Previous Part #	Brass	
				Part #	
9/16"-18	1/4"	5/8"	158-0904		1580904C
	3/8"	11/16"	158-0906		1580906C

Right-hand Thread x NPTF



Right UNF Thread	NPTF Thread	Hex	Previous Part #	Brass	
				Part #	
9/16"-18	1/4"	5/8"	156-0904		1560904C
	3/8"	11/16"	156-0906		1560906C

Oxy-Acetylene Ferrules

- sold in package quantities only



Inside Dimensions	Overall Length	Metal Gauge	Standard Ind. Part #	Brass Part #	Qty
.458" x 0.890"	15/32"	.019"	9116	<b>BFO448</b>	25
.474" x 0.943"	15/32"	.019"	9979	<b>BFO474</b>	25
.535" x 1.071"	3/4"	.024"	9940P	<b>BFO535</b>	25
.593" x 1.109"	3/4"	.024"	9593	<b>BFO593</b>	25
.700" x 1.325"	.719"	.025"	8337	<b>BFO700</b>	25

Proposition 65 Information.....	916	Water .....	936 to 937
Hose & Coupling Safety.....	916	Water constants and formulas.....	936
General Safety Information ..	916, 917	Water discharge table.....	936
Safety Is Everyone's Job ...	917 to 919	Conversion table - feet of water to inches of mercury .....	937
Be Safe .....	917	Feet head of water to PSI.....	937
S.T.A.M.P.E.D. ....	917	Thread Information .....	938 to 943
Force chart .....	918	Pipe threads .....	938
Safety products and recommendations in the DPL.....	918	NPT vs. BSP (British Standard Pipe) .....	938
MSHA regulations.....	918	Identifying threads .....	939
OSHA regulations.....	919	Thread types.....	940
Value Add Programs .....	920	Thread chart for hydraulic fittings .....	941
Solutions on Site vans by Dixon® .....	920	Fittings size chart.....	941
Best practices safety assessment .....	920	Thread dimensions.....	942
Hose coupling workshop .....	920	Normal engagement length of NPT thread in inches.....	942
Material Selection .....	921 to 926	Threads sealing tips .....	943
Selecting materials .....	921	Flange Dimensions .....	944 to 945
Corrosion resistance ratings.....	921 to 926	Flange bolt tightening sequence.....	944
Fraction to Decimal Chart .....	927	Flange diagrams.....	944
Conversion Constants/Formulas ..	928	ANSI flange dimensions .....	945
Measures of pressure.....	928	Pipe Dimensions .....	946
Length conversions constants.....	928	Dimensions of seamless and welded steel pipe 9 ASA-B36.10 and B36.19 .....	946
Weight conversion constants.....	928	Cross reference from NPS to DN specification .....	946
Circumference of a circle.....	928	Valve Selection Guides ....	947 to 948
Right cylinder.....	928	Valve selection guide.....	947
Temperature .....	929 to 931	3-way ball valve flow options .....	948
Temperature conversions.....	929		
Steam temperature and pressure conversion guide.....	930		
Pressure - temperature ratings.....	931		
Air .....	932 to 935		
Air velocity in a pipe.....	932		
Air volume discharged from pipe .....	932		
Boyle's law.....	932		
Air supply requirements.....	932		
CFM vs. PSI for nozzles .....	933		
Air receiver capacities .....	933		
Air hose friction.....	934		
Max. rec. air flow (SCFM) through ANSI metal pipe.....	935		
Suggested pipe size for compressed air flow at 100 PSI ...	935		

## Proposition 65 Information

### WARNING

As a company that may sell or distribute Dixon® couplings, adapters, valves and connectors made of brass to California consumers or to other persons or entities that may sell such items to California consumers, Dixon® is obligated to notify you of the following:

- Such products may not be sold to California consumers unless it either contains less than 300 ppm of lead when analyzed pursuant to the EPA test method 3050B or equivalent or is sold or distributed with a clear, reasonable and conspicuous warning.
- So long as it is prominently displayed on the product or the packaging of the product, the following warning complies: "WARNING: This product contains a chemical known to the State of California to cause cancer, birth defects, or other reproductive harm. Do not use in connection with drinking water. Wash hands after handling."
- As to internet sales only, if the product is not labeled with the required warning, there must be a warning message by a clearly marked hyperlink on the product display page or otherwise prominently displayed to the purchaser before the purchaser completes the purchase of the product.

There are significant penalties associated with failure to comply with these requirements. Should you need further explanation or assistance in complying with notice, please do not hesitate to contact Dixon® at sales@dixonvalve.com.

**⚠ WARNING** Failure to use these procedures can result in serious injury or death, and destruction of property and equipment.

## Hose and Hose Coupling Safety

**"The very properties that make compressed gases useful in almost every area of modern life can also make them dangerous when mishandled. Years of experience with compressed gases have led to practices and equipment which, if employed, result in complete safety."**<sup>1</sup>

Dixon® hose couplings have been carefully engineered to meet specific requirements. If hose or couplings are not used in correct applications or are incorrectly applied, accidents and downtime can result. It is up to the end user to inform the distributor of the application and pressures involved when ordering hose assemblies and it is up to the distributor to supply the right hose and coupling for that application. When in doubt, Dixon® is here to help you with a proper coupling recommendation.

**1. Air hose couplings** - This form of energy can be one of the most dangerous because it is used in so many applications and, when mishandled, can have more serious results than fluids. Air, as a gas, is compressible (fluids press only against hose or vessel walls and lose little volume under pressure). When pressurized air releases suddenly, it does so with explosive force and can cause rapid hose whip, which can do serious physical harm to personnel or damage to nearby objects. This is why the selection of proper hose and couplings for air lines is so important, along with their proper installation and maintenance. Never take for granted that a coupling is installed properly or a clamp fully tightened on an air hose - check it regularly and use safety devices (see paragraph 4).

**2. Steam and gas** - The same rules apply for steam and gas, but, because these are inherently more hazardous materials, personnel tend to treat hose and couplings on these lines with more respect and care. Checking clamp tightness is very important with steam hose, where it is not unusual for clamps to loosen in service, in which case they must be retightened! Safety devices should also be used (see paragraph 4).

**3. Fluid hose couplings** - Again, nothing should be taken for granted - in particular, check clamps for tightness each time the lines are used - especially when petroleum products or other hazardous liquids are involved. Large diameter hose, when suspended, can also be quite dangerous if it drops unexpectedly due to a coupling "pull-out" or sudden disconnection. A heavy fitting or clamp, plus the weight of the hose itself falling from any significant height, can cause injuries or damage. Be sure to use safety devices (see paragraph 4).

**4. All hose assemblies** - All hose assemblies should be treated with respect as potential hazards. Worn-out fittings should be replaced. Retaining devices such as clips, cables or chains should be used. Clamps should be checked regularly. Under no circumstances should any coupling be disconnected while under pressure, unless the coupling is specifically designed to do so. Disconnecting couplings under pressure could result in serious injury or death, and destruction of property and equipment.

<sup>1</sup> "Handbook of Compressed Gases"

## General Safety Information

### Pressure Ratings

Pressure ratings for couplings, as stated in this catalog, are based upon ambient temperature **70°F (21°C)** applications with true hose ID, new Dixon® supplied couplings, new Dixon® supplied clamps, new quality hose, and proper installation by a qualified assembler using Dixon® procedures and equipment. In addition, temperature can affect coupling retention. For temperatures other than ambient (**70°F**), contact the hose manufacturer or call Dixon® at 800.355.1991.

### Product Selection

Many of the products in this catalog are used in hose assemblies in a variety of applications. The safety of any hose assembly rests on the proper selection, installation, testing and use of each product. The safe use of any product in this catalog is dependent upon the correct selection of the hose, fittings and method of attachment. To ensure such a proper selection, the user must inform the distributor of the application and pressure involved when ordering hose assemblies. The use of S.T.A.M.P.E.D. (Size, Temperature, Application, Media, Pressure, Ends, Dixon®) will help in the proper selection of hose assembly components (see page 917). The selection of couplings and clamping devices is the responsibility of the purchaser or user, based upon the hose manufacturer's recommendations. If the purchaser or user is uncertain about the use or application of a product, Dixon™ stands ready to provide information, including test results (if available), coupling and clamping recommendations and other data to help resolve those matters.

continued on the next page

## General Safety Information, continued

### Installation

To achieve a safe and reliable assembly, proper installation procedures must be followed. Each component of the assembly has a part in determining these procedures. The purchaser or user must follow proper procedures. If the purchaser or user has any questions regarding installation, please contact Dixon®.

### Testing

Dixon® recommends that all hose assemblies be tested in accordance with the hose manufacturer's recommendations.

### Re-testing and Inspection

Dixon® recommends inspection and re-testing of hose assemblies on a regular and consistent basis in accordance with the hose manufacturer's recommendations. The application determines the regularity of the inspection and re-testing schedule. Any worn-out fittings, damaged hoses or missing safety devices should be replaced immediately. Bolt-style clamps must be checked and retightened on a regular and consistent basis.

All hose assemblies should be viewed as potential hazards. This document is designed to inform and educate anyone who manufactures, specifies, supplies, purchases, assembles, uses, maintains or tests any hose assembly or its component parts. The proper selection and maintenance of hose, couplings, attachment devices and accessories is imperative.

It is the end user's responsibility to identify to the distributor the application and any special conditions that the hose assembly must meet. It is the distributor's responsibility to supply the proper assembly for the intended application. Accidents and down time may occur if hose assemblies are not properly selected for the specific application.

The performance and safety of the assembly is affected by the quality of the individual components. The use of the acronym S.T.A.M.P.E.D. (Size, Temperature, Application, Media, Pressure, Ends, Dixon®) will help in the proper selection of the hose assembly components (see below). If anyone is uncertain about the use or application of a product, Dixon® can provide test results, coupling and clamping recommendations and other data to help resolve those matters. Call 800.355.1991 with any questions.

## Be Safe

Hose assemblies must be inspected prior to each use. Worn out fittings, attachment devices, hose and accessory items must be replaced. Retaining devices (safety devices) such as clips, cables or chains must be used. Clamps must be checked regularly to the specified torque found in the Dixon® literature. Under no circumstance should any coupling be disconnected while under pressure unless the coupling is specifically designed to do so. Disconnecting couplings under pressure could result in serious injury or death, and destruction to property and equipment.

For all hose assemblies in use:

- Beware** - Hose assemblies when used improperly or in the wrong application can be dangerous. The maximum working pressure shown on the hose is not an indication of the working pressure of the assembly. Based on the hose, fittings and attachment method used, all assemblies should be permanently marked with the designed working pressure and the intended media. The assembly working pressure should be permanently displayed. Hose assemblies must be used for the intended service only. Never alter manufactured product or substitute component parts.
- Eliminate** - hazardous conditions by inspecting, maintaining and testing hose assemblies. Dixon® recommends that all hose assemblies be tested in accordance with the hose manufacturer's specifications. The application determines the regularity of the re-testing schedule.
- Secure** - and inspect hose, fittings, clamping devices and safety accessories before each use. Never take for granted that the coupling or attachment devices are properly installed.
- Always** - inspect and re-tighten the bolts of any bolt style clamping device to the manufacturer's torque specifications.
- Fittings** - hose and clamping devices that are worn out or damaged must be removed from service.
- Educate** - your employees about the proper use, care and potential hazards of hose assemblies. Take advantage of Dixon's free Hose Assembly Safety Program and the follow up Training Seminar to aid you in setting up your own inspection program. Any questions on applications, use or assembly call 800.355.1991.

## S.T.A.M.P.E.D.

When fabricating and specifying hose assemblies ask the following questions:

- Size:** What is the ID (Inside Diameter) of the hose? What is the OD (Outside Diameter) of both ends of the hose? What is the overall length of the assembly required?
- Temperature:** What is the temperature range of the media (product) that is flowing through the hose assembly? What is the temperature range of the environment that surrounds the outside of the hose assembly?
- Application:** How is the hose assembly actually being used? Is it a pressure application? Is it a vacuum (suction) application? Is it a gravity flow application? Are there any special requirements that the hose assembly is expected to perform? Is the hose being used in a horizontal or vertical position? Are there any pulsations or vibrations acting on the hose assembly?
- Media:** What is the media/material that is flowing through the hose assembly? Being specific is critical. Check for: Abrasive materials, chemical compatibility, etc.
- Pressure:** What is the maximum pressure including surges (or, maximum vacuum) that this hose assembly will be subjected to? Always rate the maximum working pressure of your hose assembly by the lowest rated component in the system.
- Ends:** What couplings have been requested by the user? Are they the proper fittings for the application and hose selected?
- Dixon®:** Dixon® recommends that, based on the hose, fittings and attachment method used, all assemblies be permanently marked with the designed working pressure and intended media. Do not use other manufacturer's fittings or ferrules with Dixon® products due to the differences in dimensions and tolerances. We also recommend that all hose assemblies be tested frequently. *Be Safe:* Any questions on application, use or assembly call 800.355.1991.

### Force Chart

- For hose ID's from 1¼" to 12" the force in pounds is greater than the PSI.
- Force is the dynamic power which is exported longitudinally through a hose, towards the ends. To arrive at the number of pounds of force exerted, you merely multiply the area of the ID times the working pressure being used.
- Area of a circle: r<sup>2</sup> (PI [3.1416] times radius squared)
- Force = Area x Pressure

Force (In Pounds)

Safety & Technical	Hose ID	25 PSI	50 PSI	75 PSI	100 PSI	150 PSI	200 PSI	250 PSI	300 PSI	500 PSI	1000 PSI
	¼"	1	2	4	5	7	10	12	15	25	49
⅜"	3	6	8	11	17	22	28	33	55	110	
½"	5	10	15	20	29	39	49	59	98	196	
¾"	11	22	33	44	66	88	110	133	221	442	
1"	20	39	59	79	118	157	196	236	393	785	
1¼"	31	61	92	123	184	245	307	368	614	1227	
1½"	44	88	133	177	265	353	442	530	884	1767	
2"	79	157	236	314	471	628	785	942	1571	3142	
2½"	123	245	368	491	736	982	1227	1473	2454	4909	
3"	177	353	530	707	1060	1414	1767	2121	3534	7069	
4"	314	628	942	1257	1885	2513	3142	3770	6283	12566	
5"	491	982	1473	1964	2945	3927	4909	5891	9818	19635	
6"	707	1414	2121	2827	4241	5655	7069	8482	14137	28274	
8"	1257	2513	3770	5027	7540	10053	12566	15080	25133	50266	
10"	1964	3927	5891	7854	11781	15708	19635	23562	39270	78540	
12"	2827	5655	8482	11310	16965	22620	28274	33929	56549	113098	

## Safety Products and Recommendations in the Dixon® Price List

**Safety is everyone's concern!**

Dixon® provides many safety products designed to protect personnel and property. Recommendations and safety warnings are also included for your review.

Hose and coupling safety .....	page 916
S.T.A.M.P.E.D. ....	page 917
EZ Boss-Lock™ handles.....	page 166
Cam and groove safety clips.....	page 171
Air King™ - not to be used for steam statement .....	page 283
King™ cable safety cables .....	page 362
Safety shut-off valves, OSHA REG. 1926.302 .....	page 556
30 PSI safety blow guns.....	page 371
Safety vented ball valves.....	page 534
Safety tags and safety tape.....	page 910
The importance of whip hose statement .....	page 282

## MSHA (Mine Safety and Health Administration) Regulations

### 30 CFR Sections 56.13021 and 57.13021

Except where automatic shut-off valves are used, safety chains or other suitable locking devices shall be used at connections to machines of high-pressure hose line of ¾" inside diameter or larger, and between high-pressure hose lines of ¾" inside diameter or larger, where a connection failure would create a hazard.

### 30 CFR Section 75.1730

(e) Safety chains, suitable locking devices, or automatic cut-off valves shall be used at connections to machines of high-pressure hose lines of ¾" inside diameter or larger, and between high-pressure hose lines of ¾" inside diameter or larger, where a connection failure would create a hazard. For purposes of this paragraph, high-pressure means pressure of 100 PSI or more.

### 30 CFR Section 77.412

(d) Safety chains or suitable locking devices shall be used at connections to machines of high-pressure hose line of 1" inside diameter or larger, and between high-pressure hose line of 1" inside diameter or larger, where a connection failure would create a hazard.

The regulations may be viewed in full on the Mine Safety and Health Administration website, [msha.gov](http://msha.gov), please check the website for updates.



## OSHA Regulations

### Standards - 29 CFR, 1910.242 (partial):

(b) Compressed air used for cleaning - Compressed air shall not be used for cleaning purposes except where reduced to less than 30 PSI and then only with effective chip guarding and personal protective equipment.

### Standards - 29 CFR, 1915.131 (partial):

(e) Before use, pneumatic tools shall be secured to the extension hose or whip by some positive means to prevent the tool from becoming accidentally disconnected from the whip.

### Standards - 29 CFR, 1926.302 (partial):

- (b)(1) Pneumatic power tools shall be secured to the hose or whip by some positive means to prevent the tool from becoming accidentally disconnected.
- (b)(2) Safety clips or retainers shall be securely installed and maintained on pneumatic impact (percussion) tools to prevent attachments from being accidentally expelled.
- (b)(3) All pneumatically driven nailers, staplers and other similar equipment provided with automatic fastener feed, which operate at more than 100 PSI pressure at the tool shall have a safety device on the muzzle to prevent the tool from ejecting fasteners, unless the muzzle is in contact with the work surface.
- (b)(4) Compressed air shall not be used for cleaning purposes except where reduced to 30 PSI and then only with effective chip guarding and personal protective equipment which meets the requirements of Subpart E of this part. The 30 PSI requirement does not apply for concrete form, mill scale and similar cleaning purposes.
- (b)(5) The manufacturer's safe operating pressure for hoses, pipes, valves, filters and other fittings shall not be exceeded.
- (b)(6) The use of hoses for hoisting or lowering tools shall not be permitted.
- (b)(7) All hoses exceeding ½" inside diameter shall have a safety device at the source of supply or branch line to reduce pressure in case of hose failure.

### Standards - 29 CFR, 1926.306:

#### (a) General requirements

(a)(1) Application. This section applies to compressed air receivers, and other equipment used in providing and utilizing compressed air for performing operations such as cleaning, drilling, hoisting, and chipping. On the other hand, however, this section does not deal with the special problems created by using compressed air to convey materials nor the problems created when men work in compressed air as in tunnels and caissons. This section is not intended to apply to compressed air machinery and equipment used on transportation vehicles such as steam railroad cars, electric railway cars, and automotive equipment.

#### (a)(2) New and existing equipment.

(a)(2)(i) All new air receivers installed after the effective date of these regulations shall be constructed in accordance with the 1968 edition of the A.S.M.E. Boiler and Pressure Vessel Code Section VIII.

(a)(2)(ii) All safety valves used shall be constructed, installed and maintained in accordance with the A.S.M.E. Boiler and Pressure Vessel Code, Section VIII Edition 1968.

#### (b) Installation and equipment requirements

(b)(1) Installation. Air receivers shall be so installed that all drains, handholes, and manholes therein are easily accessible. Under no circumstances shall an air receiver be buried underground or located in an inaccessible place.

(b)(2) Drains and traps. A drain pipe and valve shall be installed at the lowest point of every air receiver to provide for the removal of accumulated oil and water. Adequate automatic traps may be installed in addition to drain valves. The drain valve on the air receiver shall be opened and the receiver completely drained frequently and at such intervals as to prevent the accumulation of excessive amounts of liquid in the receiver.

#### (b)(3) Gauges and valves.

(b)(3)(i) Every air receiver shall be equipped with an indicating pressure gauge (so located as to be readily visible) and with one or more spring-loaded safety valves. The total relieving capacity of such safety valves shall be such as to prevent pressure in the receiver from exceeding the maximum allowable working pressure of the receiver by more than 10 percent.

(b)(3)(ii) No valve of any type shall be placed between the air receiver and its safety valve or valves.

### Standards - 29 CFR, 1926.603 (partial):

(a)(9) Steam hose leading to a steam hammer or jet pipe shall be securely attached to the hammer with an adequate length of at least ¼" diameter chain or cable to prevent whipping in the event the joint at the hammer is broken. Air hammer hoses shall be provided with the same protection as required for steam lines.

(a)(10) Safety chains, or equivalent means, shall be provided for each hose connection to prevent the line from thrashing around in case the coupling becomes disconnected.

*The regulations may be viewed in full on the OSHA website, [osha.gov](http://osha.gov), please check the website for updates.*

## Solutions on Site Vans by Dixon®

Safety &  
Technical

Our Solutions on Site (SOS) vans are outfitted with product samples, videos, literature and products representative of what Dixon® provides to specific markets. Call 800.355.1991 for additional information.

### Best Practices Safety Assessment

Dixon®, in partnership with your industrial hose supplier, is pleased to offer a hose and coupling safety survey of your plant, at no cost to you, to assist in your efforts to make your facility as safe, efficient and productive as possible.

Today, plant safety is an enormous, ongoing endeavor in which it is impossible to be an expert in every field.

The use of damaged or misapplied hose couplings and related items occurs. To the untrained eye, these hazards may continue to exist until an accident happens, threatening not only plant machinery, but also the well-being of plant personnel.

Our program includes a visual inspection of hose assemblies and related accessories in your plant by trained technicians. A professionally written report containing our observations and recommendations for corrective action is subsequently provided to augment your own ongoing safety program. If desired, photographs of the areas of concern can be supplied with the report. As a follow-up, the program offers an educational hands-on seminar directly relating to the safety concerns in your facility.

Plant safety is coming under increasing scrutiny by various regulatory agencies. Let Dixon® trained personnel assist you in establishing and maintaining safety compliance in your plant.

The safety survey report is completely confidential and will only be shown to authorized plant personnel. For more information, please contact Dixon® at 800.355.1991.

### Hose Coupling Workshop

In an effort to provide our customers with information regarding the proper and safe methods of assembling hose and couplings, Dixon® offers Hose Coupling Workshops suitable for a company's sales force and shop personnel.

Classes consist of lectures and/or hands-on demonstrations of coupling selection, hose preparation, coupling installation, assembly testing and maintenance procedures. Morning, afternoon and all day classes are available. For more information, please visit [dixonvalve.com/hcw](http://dixonvalve.com/hcw) or call 800.355.1991.

We encourage you to share this information with anyone who may be affected by the selection, installation, maintenance or use of any hose assembly. Always use quality products to **Be Safe**.

## Selecting Materials

This information is intended to help make general comparisons between different available materials.

Material	Features and Benefits
Stainless Steel	A corrosion-resistant material that provides high strength at high temperatures, helps prevent contamination of product being transported, maintains cleanliness, and retains a lustrous appearance. Harder than brass. <i>Type 304</i> is a low-carbon chromium-nickel stainless steel. <i>Type 316</i> is similar to type 304, but has a high nickel content as well as a molybdenum for stronger resistance to heat and corrosion. Often used for water, oil, gas, and steam in low- to high-pressure applications.
Brass	Has good corrosion resistance and is less expensive than stainless steel. Is softer and easier to thread than stainless steel and forms tight seals. It can be used interchangeably with copper where heavier walls are required. Found in plumbing and heating application. Also good with oil, natural gas, and air. Resists corrosion from salt water as well as fresh water polluted with waste from mineral acids and peaty soils. Use in low- to high-pressure applications.
Steel	Used in noncorrosive environments. This carbon- and iron-based metal is hard and strong. It is an economical alternative to stainless steel and brass in high-pressure applications. For use with water, oil, gas, and steam in low- to high-pressure applications where corrosion is not a problem.

Safety & Technical

Product application is based not only on material selection but on design of product for intended use. Please contact Dixon® for selection of the proper fitting for your application.



## Corrosion Resistance of Coupling Material

### **⚠ WARNING**

The data on the following pages has been compiled from generally available sources and should not be relied upon without consulting and following the specific recommendations of the manufacturer regarding particular coupling materials.

### Ratings

Metal
1 = Excellent 2 = Good 3 = Fair X = Not Recommended - = Contact Dixon®

Non-Metal
A = Acceptable X = Not Recommended - = Contact Dixon®

Gasket/Seal Material
T = PTFE V = FKM E = EPDM, EPR N = Neoprene B = Buna N

- Ratings given are based at **70°F (21°C)**. Chemical compatibility varies greatly with temperature. For applications at temperatures other than **70°F (21°C)**, contact Dixon® for recommendations at 800.355.1991.
- Gasket / seal materials are not necessarily listed in order of preference.
- Chemical resistance of a material does not necessarily indicate the suitability of a fitting in a given application due to variables such as improper clamp and coupling application, special hose construction, gasket material, etc.



Special caution should be taken when handling hazardous materials.

Material Selection

Safety & Technical

AGENT	Aluminum	Brass	Bronze	Hastelloy, C-276	Malleable Iron Carbon Steel	Monel	Stainless Steel, 304	Stainless Steel, 316	Nylon	Polypropylene	Seal Material
Acetate Solvents (Crude)	1	X	X	1	2	2	1	1	A	X	T
Acetate Solvents (Pure)	1	1	1	1	X	1	1	1	A	X	T
Acetic Acid (80%)	3	X	X	1	X	1	1	1	X	X	TEVNB
Acetic Acid (50%)	2	X	X	1	X	2	2	1	X	X	TEVNB
Acetic Acid (20%)	2	X	X	1	X	2	2	1	X	X	TEVNB
Acetic Acid (10%)	2	X	2	1	X	2	1	1	X	X	TEVNB
Acetic Anhydride	2	X	2	1	2	2	2	2	X	X	TNB
Acetone	1	2	2	1	2	1	1	1	A	X	TE
Acetylene	1	X	X	2	2	2	1	1	X	X	TEVNB
Alcohols											
Amyl Alcohol	2	2	2	2	2	1	2	2	A	A	TEVNB
Benzyl Alcohol	2	2	2	2	2	1	1	1	X	A	TVB
Butyl Alcohol	1	2	1	2	2	1	1	1	A	A	TEVN
Diacetone Alcohol	1	1	2	1	2	1	2	2	X	A	TE
Ethyl Alcohol	1	2	2	1	2	2	2	2	X	A	TEVNB
Hexyl Alcohol	-	-	-	1	-	-	-	-	A	-	-
Isobutyl Alcohol	-	-	-	-	-	-	-	-	A	-	-
Isopropyl Alcohol	2	2	2	2	2	2	2	2	A	A	TEVNB
Methyl Alcohol (Methanol)	2	2	2	1	2	2	2	2	A	A	TENB
Octyl Alcohol	-	-	-	-	-	-	-	-	A	-	-
Propyl Alcohol	2	2	2	1	2	2	1	1	X	A	TEVNB
Aluminum											
Aluminum Chloride (Aqu.)	X	X	X	1	X	X	X	X	A	A	TEVNB
Aluminum Fluoride (Sat.)	2	-	-	-	X	2	X	2	X	A	TEVNB
Aluminum Nitrate (Sat.)	3	X	-	-	X	-	2	2	A	A	TEVNB
Aluminum Potassium Sulfate (Alum)	2	2	2	2	X	2	X	2	X	A	TEVNB
Aluminum Sulfate (Sat.)	X	X	2	2	X	2	-	2	A	A	TEVNB
Ammonia											
Ammonia Anhydrous	1	X	X	2	1	1	2	1	A	X	TENB
Ammonia Gas	X	X	X	1	1	X	1	1	A	X	TENB
Ammonia Nitrate	-	-	-	-	-	-	-	-	X	-	-
Ammonium											
Ammonium Bifluoride	-	X	-	2	X	2	-	-	X	A	TEVB
Ammonium Carbonate (Sat.)	2	X	X	2	2	2	2	2	A	A	TEVNB
Ammonium Casenate	-	-	-	-	-	-	-	-	A	-	-
Ammonium Chloride (Sat.)	X	X	2	2	X	2	X	X	A	A	TEVNB
Ammonium Hydroxide (Sat.)	2	X	X	2	1	X	2	2	A	A	TEVNB
Ammonium Nitrate	2	X	X	-	X	X	-	-	A	A	TENB
Ammonium Phosphate (10-40%)	X	X	X	-	X	2	1	2	A	A	TEVNB
Ammonium Sulfate (10-40%)	X	X	3	2	X	2	X	2	A	A	TEVNB
Aniline	-	X	2	2	X	2	1	1	X	X	TV
Arsenic Acid	X	X	2	2	X	X	2	2	X	A	TEVNB
Asphalt	-	-	-	-	2	-	-	2	X	X	TV
Barium											
Barium Carbonate (Sat.)	X	2	2	2	2	2	2	2	A	A	TEVNB
Barium Chloride (Sat.)	-	2	2	1	-	2	X	-	A	A	TEVNB
Barium Hydroxide (Sat.)	X	2	X	2	2	1	2	2	A	A	TEVNB
Barium Sulfate	2	2	2	-	X	2	2	2	A	A	TEVNB
Barium Sulfide	X	X	X	-	2	X	2	2	A	A	TEVNB
Beer	1	2	2	1	2	1	1	1	A	A	TEVNB
Benzaldehyde	2	2	2	2	X	2	2	2	X	X	TE
Benzene, Benzol	1	2	2	2	2	2	2	2	A	X	TV
Benzine	-	-	-	-	-	-	-	-	A	X	-
Benzoic Acid	2	2	2	-	X	2	2	2	X	X	TVN
Black Liquor	X	X	X	X	-	2	2	2	X	A	TEVNB
Bleach (12.5% Active Chlorine)	X	-	-	1	X	-	-	X	X	A	TEVN
Borax	X	2	2	1	2	1	1	1	X	A	TEVNB
Boric Acid	1	X	2	1	X	2	-	-	X	A	TEVNB
Brine Acid	-	2	2	1	-	-	-	-	X	A	TEVNB
Bromic acid	X	X	X	-	-	X	-	-	X	A	TEVN
Bromine Liquid	2	-	-	-	-	-	X	X	X	X	TV
Butadiene, Butylene	2	2	2	2	2	1	2	2	X	X	TVNB
Butane	2	2	2	2	1	1	2	2	X	X	TV
Butyl Acetate	1	2	2	2	2	2	2	2	A	X	T
Butyric Acid	2	2	X	1	X	2	2	2	A	A	TV

Ratings given are based at 70°F (21°C).

Material Selection

P

AGENT	Aluminum	Brass	Bronze	Hastelloy, C-276	Malleable Iron Carbon Steel	Monel	Stainless Steel, 304	Stainless Steel, 316	Nylon	Polypropylene	Seal Material
Calcium											
Calcium Bisulfate	X	-	X	-	X	X	X	2	X	A	T
Calcium Bisulfide	-	-	-	-	-	2	-	2	A	A	TVB
Calcium Bisulfite	X	X	2	2	X	X	-	2	X	A	TVNB
Calcium Bromide	X	2	2	-	X	2	1	X	X	X	T
Calcium Carbonate	X	2	2	2	2	2	1	2	A	A	TEVB
Calcium Chloride (Sat.)	-	2	-	1	2	2	-	-	A	A	TEVNB
Calcium Hydroxide (Sat.)	X	2	X	-	2	2	2	2	A	A	TEVNB
Calcium Hypochlorite (Sat.)	X	X	X	-	X	X	X	2	X	A	TEV
Carbon											
Carbon Bisulfide	1	X	2	2	2	X	2	2	A	X	TV
Carbon Dioxide (Dry)	1	1	2	1	2	1	2	2	A	A	TENB
Carbon Dioxide (Wet)	1	X	-	2	3	-	2	2	X	A	TENB
Carbon Disulfide	1	X	2	2	2	X	2	2	A	X	TV
Carbon Monoxide	1	1	1	1	2	1	1	1	A	A	TEVNB
Carbon Tetrachloride	X	-	1	1	2	1	1	-	A	X	TV
Carbonic Acid	1	2	2	1	2	3	2	2	X	A	TEVNB
Castor Oil	2	2	2	1	2	1	2	2	X	A	TEVNB
Caustic Potash	X	-	-	1	X	-	-	2	A	A	TEVNB
Caustic Soda (see Sodium Hydroxide)											
Cellosolves	2	2	2	2	2	2	2	2	X	A	TE
Chlorine (Liquid)	-	-	-	1	2	2	-	3	X	X	TV
Chloroform	-	-	-	2	X	1	-	-	X	X	TV
Chlorosulfonic Acid	-	X	X	1	2	2	X	X	X	X	T
Clorox (Bleach, 5.5% CL)	X	-	-	-	X	-	-	2	X	-	TEVB
Chromic Acid (50%)	2	X	X	2	X	X	3	-	X	X	TVNB
Citric Acid	3	X	X	1	X	2	-	-	X	A	TEVNB
Coke Oven Gas	2	3	3	-	2	2	2	2	X	X	TEVN
Copper											
Copper Chloride	X	X	X	2	X	X	X	X	A	A	TEVNB
Copper Cyanide	X	X	X	1	-	X	2	2	X	-	TEVNB
Copper Sulfate	X	X	X	1	X	X	-	2	A	A	TEVNB
Crylic Acid (Conc.)	2	2	X	-	2	3	2	2	X	X	TEV
Cyclohexane	2	2	2	2	2	1	2	2	A	X	TVB
Detergents	2	2	2	1	2	-	1	2	A	A	TEVNB
Dextrose	2	-	-	2	-	2	-	-	A	A	TEVNB
Diesel Fuels	1	1	1	2	2	-	1	1	A	X	TVB
Diethylamine	2	-	X	-	X	1	2	2	X	A	TN
Disodium Phosphate	-	-	-	-	1	-	-	1	A	A	TEV
Ethers	2	2	2	2	2	2	1	1	A	X	TB
Ethyl											
Ethyl Acetate	-	-	2	2	2	2	2	2	A	X	T
Ethyl Chloride	-	-	2	2	2	2	-	1	A	X	TEVB
Ethylene											
Ethylene Chloride	-	-	-	-	2	2	-	-	A	X	TV
Ethylene Dichloride	-	2	X	2	2	1	2	2	A	X	TV
Ethylene Glycol	1	2	2	1	2	2	2	2	A	X	TEVNB
Ethylene Oxide	X	X	X	1	3	2	2	2	X	X	T
Fatty Acids	1	3	3	1	X	2	-	1	A	A	TVNB
Ferric											
Ferric Chloride	X	X	2	2	X	X	X	X	X	A	TEVNB
Ferric Hydroxide	-	-	-	1	-	2	1	1	A	-	TEVNB
Ferric Nitrate (10-50%)	X	X	X	-	X	X	2	2	X	A	TEVNB
Ferric Sulfate	X	X	X	-	X	2	-	-	X	A	TEVNB
Ferrous											
Ferrous Chloride (Sat.)	X	X	2	2	-	X	X	X	X	A	TEVNB
Ferrous Sulfate	2	2	2	2	X	2	2	-	X	A	TEVNB
Fluoboric Acid	X	-	-	1	1	2	-	-	X	A	TEVNB
Formaldehyde (50%)	-	2	2	2	X	2	1	1	X	A	TEN
Formic Acid (Anhyd.)	1	X	2	1	X	2	-	-	X	A	TEVN
Freon											
Freon 11	2	2	2	-	X	1	2	2	X	X	TVNB
Freon 12	2	2	2	1	X	2	2	2	X	X	TVNB
Freon 22	2	2	2	2	X	2	2	2	X	X	TN
Fruit Juices	2	2	3	1	X	1	2	2	A	A	TVNB
Fuel Oil	2	2	2	2	2	2	2	2	A	X	TVNB
Furfural	2	2	2	2	2	2	2	2	A	X	TEN

Technical  
Safety &

P

Material Selection

Safety & Technical

AGENT	Aluminum	Brass	Bronze	Hastelloy, C-276	Malleable Iron Carbon Steel	Monel	Stainless Steel, 304	Stainless Steel, 316	Nylon	Polypropylene	Seal Material
<b>Gasoline</b>											
Refined Gasoline	2	2	2	2	2	2	2	2	A	X	TVNB
Sour Gasoline	X	2	2	2	2	X	2	2	A	X	TVNB
Gelatin	2	2	2	-	X	2	2	2	A	A	TEVNB
Glucose	2	2	2	-	2	2	2	2	A	A	TEVNB
Glue	2	2	2	1	2	2	-	2	-	A	TEVNB
Glycerine	1	1	2	1	2	1	1	1	A	A	TEVNB
Glycols	2	2	2	-	2	2	2	2	A	A	TEVNB
Green Liquor	-	-	-	-	2	-	-	-	-	A	TEVNB
Heptane	2	2	2	1	2	2	2	2	A	X	TVNB
Hexane	2	2	2	1	2	2	1	1	A	X	TVNB
Hydrobromic Acid (50%)	X	X	X	2	X	X	X	X	X	A	TEV
Hydrobromic Acid (20%)	X	X	X	1	X	X	X	X	X	A	TEV
Hydrochloric Acid (20%)	X	X	X	1	X	3	X	X	X	A	TEVNB
Hydrochloric Acid (38%)	X	X	X	1	X	X	X	X	X	A	TEVN
Hydrocyanic Acid	2	X	X	2	2	2	2	2	X	A	TEVN
Hydrofluosilicic Acid (10-50%)	X	2	X	2	X	2	X	2	X	-	TEVNB
<b>Hydrogen</b>											
Hydrogen Peroxide (50%)	-	X	X	2	X	2	-	-	X	A	TEV
Hydrogen Sulfide (Agu.)	-	-	-	2	-	2	X	2	X	A	TE
Hydrogen Chloride (Dry Gas)	X	2	-	1	2	1	-	-	X	A	TEVN
Hydrogen Gas	1	1	1	1	-	1	1	1	X	A	TEVNB
Hypochlorous Acid	X	X	X	2	X	X	X	X	X	X	TEV
Iodine	1	X	X	-	X	1	X	X	X	A	TEV
Isopropyl Ether	-	2	2	-	-	2	1	2	A	X	T
Jet Fuel (JP4, JP5)	2	1	2	1	2	2	2	2	X	X	TV
Kerosene	2	2	2	2	2	2	2	2	X	X	TVNB
Ketones	2	2	2	1	2	2	2	2	A	X	T
Lactic Acid (25%)	3	2	2	1	X	X	-	-	A	A	TEVN
Lactic Acid (80%)	2	2	X	2	X	-	-	-	A	A	TEVN
Lard Oil	2	-	2	1	3	2	2	2	A	A	TVB
<b>Lead</b>											
Lead Acetate	X	X	X	2	X	2	2	2	X	A	TENB
Lead Chloride	X	-	-	2	-	-	2	2	X	-	TVNB
Lead Sulfate	X	-	-	2	X	2	2	2	X	-	TEVNB
Lime Sulphur	X	X	X	-	X	2	2	2	X	A	TEVN
Linoleic Acid	2	X	3	2	X	2	2	2	X	A	TVB
Linseed Oil	2	2	2	2	2	2	2	2	A	A	TVNB
Lubricants (Oil)	2	1	-	-	2	2	2	2	A	X	TVNB
<b>Magnesium</b>											
Magnesium Carbonate	2	-	-	-	-	2	2	2	X	A	TEVNB
Magnesium Chloride	X	X	2	1	-	-	-	-	X	A	TEVNB
Magnesium Hydroxide	2	2	2	1	2	2	1	1	X	A	TEVNB
Magnesium Nitrate	2	2	2	1	2	2	2	2	X	A	TEVNB
Magnesium Oxide	-	-	-	-	-	-	-	-	X	-	-
Magnesium Sulfate	2	-	2	-	-	1	2	2	X	A	TEVNB
Maleic Acid	-	2	3	2	X	-	-	2	X	A	TEV
<b>Mercuric</b>											
Mercuric Chloride	X	X	X	-	X	X	X	-	X	A	TEVB
Mercuric Cyanide	X	X	X	2	X	2	2	2	X	A	TEVB
Mercury	X	X	X	1	2	-	1	1	A	A	TEVNB
Methane	1	1	2	1	2	1	1	1	A	X	TEVNB
Methanol	2	2	2	1	2	2	2	2	A	A	TENB
<b>Methyl</b>											
Methyl Bromide	X	-	-	-	2	-	2	2	X	X	TV
Methyl Ethyl Ketone	2	2	2	2	2	2	2	2	A	X	TE
Methyl Isobutyl Ketone	2	2	2	2	2	2	2	2	A	X	T
Methyl Methacrylate	2	-	-	-	X	-	2	2	X	A	T
Methylene Chloride	-	2	2	X	2	-	-	-	A	X	T
Milk	1	X	X	1	2	X	1	1	A	A	TEVNB
Mineral Oil	2	1	-	-	2	1	1	2	A	A	TVNB
Muriatic Acid	X	-	-	1	-	X	X	X	X	A	TV
Napthalene	2	2	2	2	2	2	1	1	A	A	TV
Naptha	2	2	2	2	2	2	2	2	A	X	TVB

Ratings given are based at 70°F (21°C).

**Material Selection**

P

<b>AGENT</b>	<b>Aluminum</b>	<b>Brass</b>	<b>Bronze</b>	<b>Hastelloy, C-276</b>	<b>Malleable Iron Carbon Steel</b>	<b>Monel</b>	<b>Stainless Steel, 304</b>	<b>Stainless Steel, 316</b>	<b>Nylon</b>	<b>Polypropylene</b>	<b>Seal Material</b>
<b>Nickel</b>											
Nickel Chloride	X	X	X	-	X	2	-	-	X	A	TEVNB
Nickel Sulfate	X	X	-	2	-	-	2	2	X	A	TEVNB
<b>Nitric</b>											
Nitric Acid (100%)	1	X	X	2	X	X	2	-	X	X	TV
Nitric Acid (50%)	X	X	X	1	X	X	2	-	X	X	TV
Nitric Acid (30%)	X	X	X	1	X	X	1	-	X	X	TV
Nitrobenzene	1	2	2	-	2	2	2	2	A	A	T
<b>Oils</b>											
Castor Oil	2	2	2	1	2	1	2	2	A	A	TEVNB
Coconut Oil	2	-	2	-	3	2	2	2	A	A	TVB
Corn Oil	2	2	2	-	2	2	-	2	A	A	TVNB
Cotton Seed Oil	2	2	2	-	2	1	2	2	A	A	TVNB
Fuel Oil	2	2	2	2	2	2	2	2	A	X	TVNB
Linseed Oil	2	2	2	2	2	2	2	2	A	A	TVNB
Mineral Oil	2	1	-	-	2	1	1	2	A	A	TVNB
Silicon Oil	2	1	2	-	2	-	2	2	A	A	TEVB
Vegetable Oil	2	2	2	1	2	1	1	1	A	X	TVNB
Oleic Acid	2	3	2	2	2	1	-	1	A	X	TB
Oleum	2	X	X	-	2	X	2	2	X	X	TV
Oxalic Acid (Sat.)	2	-	2	2	X	2	X	X	X	A	TEV
Oxygen	2	2	2	-	2	2	2	2	X	X	TEVNB
Palmitic Acid (Sat.)	2	3	2	-	3	2	2	2	X	A	TVB
Paraffin	2	2	2	2	2	2	2	2	A	A	TVNB
Perchloroethylene	2	2	2	2	2	1	-	-	X	X	TV
Petrolatum	2	-	2	-	3	2	2	2	A	-	TVNB
Phenol (Carbolic Acid)	1	1	X	1	2	1	-	1	X	X	TV
<b>Phosphoric Acid</b>											
Phosphoric Acid (25-50%)	X	X	2	1	X	X	-	-	X	A	TEVN
Phosphoric Acid (50-85%)	X	X	X	1	X	3	-	-	X	A	TEV
Photographic Solutions	-	-	-	-	X	1	1	1	X	X	TVNB
Phthalic Anhydride	-	2	2	1	2	1	1	1	X	X	TEV
Picric Acid	1	X	X	2	X	X	2	2	X	-	TEVNB
<b>Plating Solutions</b>											
Brass Plating Solution	-	-	-	1	-	-	-	2	X	A	TEVNB
Cadmium Plating Solution	-	-	-	1	-	-	-	2	X	A	TEVNB
Chrome 40% Plating Solution	X	2	2	1	X	X	2	2	X	A	TEVN
Copper (Cyanide) Plating Solution	-	-	-	1	-	-	-	-	X	A	TEVNB
Gold Plating Solution	-	-	-	1	-	-	-	1	X	A	TEVNB
Iron Plating Solution	-	-	-	-	-	-	-	-	X	A	TEVB
Lead Plating Solution	-	-	-	-	-	-	1	1	X	A	TEVNB
Nickel Plating Solution	-	-	-	1	-	-	1	1	X	A	TEVNB
Silver Plating Solution	-	-	-	1	-	-	1	1	X	A	TEVNB
Tin Plating Solution	-	-	-	1	-	-	-	3	X	A	TEVNB
Zinc Plating Solution	-	-	-	1	-	-	-	-	X	A	TEVNB
<b>Potassium</b>											
Potassium Acetate	X	X	X	-	2	-	-	-	A	A	TEVB
Potassium Bicarbonate (30%)	X	2	-	2	2	2	1	1	A	A	TEVNB
Potassium Carbonate (50%)	X	2	X	2	2	2	1	1	A	A	TEVNB
Potassium Chlorate (30%)	2	X	X	-	2	2	2	1	X	A	TEVNB
Potassium Chloride (30%)	X	X	2	-	2	1	-	-	A	A	TEVNB
Potassium Chromate (30%)	2	2	2	2	-	2	2	2	X	A	TEVB
Potassium Cyanide Solution (30%)	X	X	X	2	2	2	2	2	X	A	TEVNB
Potassium Dichromate (30%)	1	2	2	2	2	2	1	1	X	A	TEVB
Potassium Hydroxide (90%)	X	X	X	2	-	2	X	-	X	A	TENB
Potassium Nitrate (80%)	1	2	2	2	2	2	2	2	X	A	TEVNB
Potassium Permanganate (20%)	2	2	2	1	2	2	2	2	X	A	TEVN
Potassium Sulfate (10%)	1	2	2	1	2	1	1	1	A	A	TEVNB
Propane	1	1	1	2	2	1	2	2	X	X	TVB
Propylene Glycol	2	2	2	2	2	2	2	2	A	A	TVNB
Propylene Oxide (90%)	-	-	-	-	-	-	1	1	X	X	TE
Pyridine	2	2	2	-	2	2	2	2	A	X	T
Pyrogalllic Acid	2	2	2	2	2	2	2	2	X	X	TVNB
Silver Nitrate	X	X	X	-	X	X	2	1	X	A	TEVNB
Soap Solutions	2	2	2	1	2	2	2	2	A	A	TEVNB

Technical  
Safety &

P

Ratings given are based at 70°F (21°C).

Material Selection

Safety & Technical

AGENT	Aluminum	Brass	Bronze	Hastelloy, C-276	Malleable Iron Carbon Steel	Monel	Stainless Steel, 304	Stainless Steel, 316	Nylon	Polypropylene	Seal Material
Sodium											
Sodium Acetate	1	2	2	-	X	2	2	2	A	A	TEN
Sodium Bicarbonate (20%)	2	2	2	1	3	1	1	1	A	A	TEVNB
Sodium Bisulfate	X	-	2	2	2	-	-	-	A	A	TEVNB
Sodium Bisulfite	X	2	X	2	X	-	-	-	A	A	TEVNB
Sodium Borate	2	2	2	2	3	2	2	2	A	A	TEVNB
Sodium Perborate (10%)	2	X	2	2	2	2	2	2	X	A	TEVNB
Sodium Carbonate	X	2	-	2	2	1	-	2	A	A	TEVNB
Sodium Chlorate (50%)	2	2	2	1	X	1	2	2	X	A	TEVNB
Sodium Cyanide	X	X	X	2	2	X	-	-	A	A	TEVNB
Sodium Dichromate	2	X	X	1	2	-	2	2	X	A	TE
Sodium Hydroxide (70%)	X	X	X	1	3	1	2	2	X	A	TENB
Sodium Hydroxide (50%)	X	X	3	1	3	1	1	-	X	A	TENB
Sodium Hydroxide (30%)	X	2	3	2	2	1	1	1	X	A	TENB
Sodium Chloride (30%)	X	2	2	2	2	1	-	-	X	A	TEVNB
Sodium Hypochlorite	X	X	X	-	X	X	-	-	X	A	TEV
Sodium Metaphosphate	X	X	2	-	X	2	2	2	X	X	TEVNB
Sodium Nitrate (40%)	1	2	-	-	2	2	1	1	A	A	TENB
Sodium Perborate (10%)	2	X	2	2	2	2	2	2	X	A	TEVNB
Sodium Peroxide (10%)	2	X	X	2	2	2	2	2	X	A	TEVNB
Sodium Silicate	1	2	2	2	2	2	2	2	A	A	TEVNB
Sodium Sulfate	-	2	2	2	2	-	-	1	A	A	TEVNB
Sodium Sulfide (50%)	X	X	X	2	2	2	-	2	X	A	TEVNB
Sodium Thiosulphate	2	X	X	2	X	2	2	2	A	A	TEVNB
Stannic Chloride	X	X	X	-	X	X	X	X	X	A	TEVNB
Stannous Chloride	X	X	X	2	X	-	X	-	X	X	TEVNB
Steam	-	-	-	-	-	-	-	-	X	-	-
Stearic Acid	2	3	2	1	3	3	2	1	A	A	TVNB
Stoddard's Solvent	2	2	2	1	2	2	2	2	X	A	TVB
Sugar Liquors (Cane)	1	2	1	-	2	2	2	2	A	A	TEVNB
Sugar Liquors (Beet)	1	2	1	-	2	1	1	1	A	A	TEVNB
Sulfate Liquors	2	X	X	2	3	2	-	2	X	A	TVNB
Sulfite Liquors	X	X	-	1	X	X	2	2	X	X	TVNB
Sulfur Chloride	X	-	X	2	X	X	-	-	X	X	TV
Sulfur Dioxide (Dry)	2	2	2	2	1	2	-	2	X	A	TE
Sulfur Trioxide	2	2	X	2	2	2	-	2	X	X	TEV
Sulfuric Acid (TO 10%)	X	2	X	1	X	X	X	X	X	A	TEVNB
Sulfuric Acid (100%)	X	X	X	1	2	X	-	-	X	X	TV
Sulfurous Acid	2	2	X	-	X	X	X	-	X	A	TV
Tannic Acid	X	-	X	-	X	2	2	2	X	A	TEVNB
Tanning Liquors	1	-	2	1	-	-	1	1	X	A	TVNB
Tartaric Acid	-	-	2	2	-	-	1	1	A	A	TVNB
Titanium Tetrachloride	X	X	X	2	2	2	-	2	X	X	TV
Toluene	1	1	1	1	1	1	1	1	A	X	TVB
Tetrahydrofuran	X	-	2	1	1	-	1	2	A	X	T
Tomato Juice	2	-	3	2	3	2	2	2	X	A	TEVNB
Trichloroethylene	1	-	2	1	2	-	-	-	A	X	TV
Triethanolamine	2	X	2	2	2	2	2	2	A	X	TEVN
Triethylamine	-	-	-	-	-	2	2	2	A	X	TVB
Trisodium Phosphate (10%)	X	2	-	1	2	2	1	1	A	A	TVNB
Turpentine	2	X	2	2	2	1	1	1	X	X	TVB
Urea (50%)	2	-	2	-	2	2	2	2	A	A	TEVNB
Urine	-	-	-	-	2	-	1	1	X	A	TEVNB
Vinegar	X	X	2	2	2	2	2	2	X	A	TEVN
Water Acid (Mine)	X	X	X	1	X	-	-	-	X	A	TEVNB
Water (Distilled)	X	2	2	1	X	X	2	2	A	A	TEVNB
Water (Sea)	2	2	2	1	X	2	2	2	A	A	TEVNB
Whiskey	X	2	2	1	2	2	1	1	X	A	TEVNB
White Liquor (Pulp)	2	-	X	2	X	X	2	2	X	A	TEVNB
Wine	X	2	2	1	X	2	1	1	X	A	TEVNB
Xylene	2	2	2	1	2	2	2	2	A	X	TV
Zinc											
Zinc Chloride	X	X	X	2	X	-	X	2	A	A	TEVNB
Zinc Nitrate	-	-	-	-	-	-	2	2	X	A	TEVNB
Zinc Sulfate (50%)	X	2	2	2	X	2	1	1	X	A	TEVNB

Ratings given are based at 70°F (21°C).





## Measures of Pressure

1 Pound Per Square Inch = 144 Pounds Per Square Foot = 0.068 Atmosphere = 2.042 Inches of Mercury at 62°F = 27.7 Inches of Water at 62°F = 2.31 Feet of Water at 62°F.

1 Atmosphere = 30 Inches of Mercury at 62°F = 14.7 Pounds Per Square Inch = 2116.3 Pounds Per Square Foot = 33.95 Feet of Water at 62°F.

1 Foot of Water at 62°F = 62.355 Pounds Per Square Foot = 0.433 Pounds Per Square Inch.

1 Inch of Mercury at 62°F = 1.132 Feet of Water = 13.58 Inches of Water = 0.491 Pounds Per Square Inch.

Column of Water 12 Inches High, 1 Inch in Diameter = .341 Pounds

If temperature is kept constant, the volume of a given mass of gas is inversely proportional to the pressure which is exerted upon it.

## Length Conversion Constants

Millimeters x .039370 = Inches

Meters x 39.370 = Inches

Meters x 3.2808 = Feet

Meters x 1.09361 = Yards

Kilometers x 3,280.8 = Feet

Kilometers x .62137 = Statute Mile

Kilometers x .53959 = Nautical Miles

Inches x 25.4001 = Millimeters

Inches x .0254 = Meters

Feet x .30480 = Meters

Yards x .91440 = Meters

Feet x .0003048 = Kilometers

Statute Miles x 1.60935 = Kilometers

Nautical Miles x 1.85325 = Kilometers

## Weight Conversion Constants

Grams x .03527 = Ounces (Avd.)

Grams x .033818 = Fluid Ounces (Water)

Kilograms x 35.27 = Ounces (Avd.)

Kilograms x 2.20462 = Pounds (Avd.)

Ounces (Avd.) x 28.35 = Grams

Fluid Ounces (Water) x 29.57 = Grams

Ounces (Avd.) x .02835 = Kilograms

Pounds (Avd.) x .45359 = Kilograms

## Circumference of a Circle

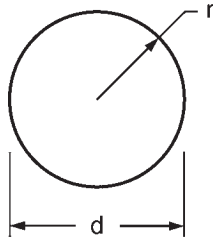

$$\text{Circumference} = 2\pi r = \pi d = 3.14159 d$$

$$\text{Area} = \pi r^2 = \pi \frac{d^2}{4} = .78539d^2$$

## Right Cylinder

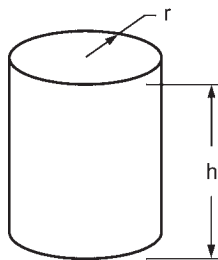

r = radius

h = length

$$\text{Volume} = \pi r^2 h$$

$$\text{Surface Area} = 2\pi r (r + h)$$

If end planes are parallel but not at 90° to h, the same formulas apply, but a slice at 90° through the cylinder must be used to determine r.

### Temperature Conversions

Look up reading in middle column (shaded). If in degrees Centigrade, read Fahrenheit equivalent in right-hand column; if in degrees Fahrenheit, read Centigrade equivalent in left-hand column.

°C	°F	°C	°F
-73	-100	-148	
-68	-90	-130	
-62	-80	-112	
-57	-70	-94	
-51	-60	-76	
-46	-50	-58	
-40	-40	-40	
-34	-30	-22	
-29	-20	-4	
-23	-10	14	
-17.8	0	32	
-17.2	1	33.8	
-16.7	2	35.6	
-16.1	3	37.4	
-15.6	4	39.2	
-15.0	5	41.0	
-14.4	6	42.8	
-13.9	7	44.6	
-13.3	8	46.4	
-12.8	9	48.2	
-12.2	10	50.0	
-11.7	11	51.8	
-11.1	12	53.6	
-10.6	13	55.4	
-10.0	14	57.2	
-9.4	15	59.0	
-8.9	16	60.8	
-8.3	17	62.6	
-7.8	18	64.4	
-7.2	19	66.2	
-6.7	20	68.0	
-6.1	21	69.8	
-5.6	22	71.6	
-5.0	23	73.4	
-4.4	24	75.2	
-3.9	25	77.0	
-3.3	26	78.8	
-2.8	27	80.6	
-2.2	28	82.4	
-1.7	29	84.2	
-1.1	30	86.0	
-.6	31	87.8	
0	32	89.6	
.6	33	91.4	
1.1	34	93.2	
1.7	35	95.0	
2.2	36	96.8	
2.8	37	98.6	
3.3	38	100.4	
3.9	39	102.2	
4.4	40	104.0	

°C	°F	°C	°F
5.0	41	105.8	
5.6	42	107.6	
6.1	43	109.4	
6.7	44	111.2	
7.2	45	113.0	
7.8	46	114.8	
8.3	47	116.6	
8.9	48	118.4	
9.4	49	120.2	
10.0	50	122.0	
10.6	51	123.8	
11.1	52	125.6	
11.7	53	127.4	
12.2	54	129.2	
12.8	55	131.0	
13.3	56	132.8	
13.9	57	134.6	
14.4	58	136.4	
15.0	59	138.2	
15.6	60	140.0	
16.1	61	141.8	
16.7	62	143.6	
17.2	63	145.4	
17.8	64	147.2	
18.3	65	149.0	
18.9	66	150.8	
19.4	67	152.6	
20.0	68	154.4	
20.6	69	156.2	
21.1	70	158.0	
21.7	71	159.8	
22.2	72	161.6	
22.8	73	163.4	
23.3	74	165.2	
23.9	75	167.0	
24.4	76	168.8	
25.0	77	170.6	
25.6	78	172.4	
26.1	79	174.2	
26.7	80	176.0	
27.2	81	177.8	
27.8	82	179.6	
28.3	83	181.4	
28.9	84	183.2	
29.4	85	185.0	
30.0	86	186.8	
30.6	87	188.6	
31.1	88	190.4	
31.7	89	192.2	
32.2	90	194.0	
32.8	91	195.8	

°C	°F	°C	°F
33.3	92	197.6	
33.9	93	199.4	
34.4	94	201.2	
35.0	95	203.0	
35.6	96	204.8	
36.1	97	206.6	
36.7	98	208.4	
37.2	99	210.2	
37.8	100	212.0	
43	110	230	
49	120	248	
54	130	266	
60	140	284	
66	150	302	
71	160	320	
77	170	338	
82	180	356	
88	190	374	
93	200	392	
99	210	410	
100	212	413.6	
104	220	428	
110	230	446	
116	240	464	
121	250	482	
127	260	500	
132	270	518	
138	280	536	
143	290	554	
149	300	572	
154	310	590	
160	320	608	
166	320	626	
170	338	640	
171	340	644	
177	350	662	
182	360	680	
186	366	691	
188	370	698	
193	380	716	
198	388	730	
199	390	734	
204	400	752	
208	406	763	
210	410	770	
216	420	788	
221	430	806	
227	440	824	
232	450	842	

Steam Temperature and Pressure Conversion Guide

Temperature - Pressure Equivalents of Saturated Steam Gauge Pressure at Sea Level

• Degrees Celsius = 5/9 (Degrees F - 32)

Safety & Technical

Temperature		Lbs. per Sq. Inch	Temperature		Lbs. per Sq. Inch	Temperature		Lbs. per Sq. Inch
°F	°C		°F	°C		°F	°C	
212	100.0	0.0	286	141.1	39.4	336	168.9	97.1
214	101.1	0.6	287	141.7	40.3	337	169.4	98.7
216	102.2	1.2	288	142.2	41.1	338	170.0	100.2
218	103.3	1.8	289	142.8	42.0	339	170.6	101.8
220	104.4	2.5	290	143.3	42.9	340	171.1	103.3
222	105.6	3.2	291	143.9	43.8	341	171.7	105.0
224	106.7	3.9	292	144.4	44.7	342	172.2	106.5
226	107.8	4.6	293	145.0	45.6	343	172.8	108.2
228	108.9	5.3	294	145.6	46.5	344	173.3	109.8
230	110.0	6.1	295	146.1	47.5	345	173.9	111.5
232	111.1	6.9	296	146.7	48.4	346	174.4	113.1
234	112.2	7.7	297	147.2	49.4	347	175.0	114.8
236	113.3	8.5	298	147.8	50.3	348	175.6	116.5
238	114.4	9.4	299	148.3	51.3	349	176.1	118.2
240	115.6	10.3	300	148.9	52.3	350	176.7	119.9
242	116.7	11.2	301	149.4	53.4	352	177.8	123.5
244	117.8	12.1	302	150.0	54.4	354	178.9	127.1
246	118.9	13.1	303	150.6	55.4	356	180.0	130.8
248	120.0	14.1	304	151.1	56.4	358	181.1	134.5
250	121.1	15.1	305	151.7	57.5	360	182.2	138.3
252	122.2	16.2	306	152.2	58.6	362	183.3	142.3
254	123.3	17.3	307	152.8	59.7	364	184.4	146.2
256	124.4	18.4	308	153.3	60.7	366	185.6	150.3
258	125.6	19.6	309	153.9	61.9	368	186.7	154.4
260	126.7	20.7	310	154.4	63.0	370	187.8	158.7
261	127.2	21.4	311	155.0	64.2	372	188.9	163.0
262	127.8	22.0	312	155.6	65.3	374	190.0	167.4
263	128.3	22.6	313	156.1	66.5	376	191.1	171.9
264	128.9	23.2	314	156.7	67.6	378	192.2	176.4
265	129.4	23.9	315	157.2	68.8	380	193.3	181.1
266	130.0	24.5	316	157.8	70.0	382	194.4	185.8
267	130.6	25.2	317	158.3	71.3	384	195.6	190.6
268	131.1	25.8	318	158.9	72.5	386	196.7	195.6
269	131.7	26.5	319	159.4	73.7	388	197.8	200.6
270	132.2	27.2	320	160.0	75.0	390	198.9	205.7
271	132.8	27.9	321	160.6	76.3	392	200.0	210.9
272	133.3	28.6	322	161.1	77.5	394	201.1	216.2
273	133.9	29.3	323	161.7	78.8	396	202.2	221.5
274	134.4	30.0	324	162.2	80.1	398	203.3	227.0
275	135.0	30.8	325	162.8	81.5	400	204.4	232.6
276	135.6	31.5	326	163.3	82.8	402	205.5	238.0
277	136.1	32.3	327	163.9	84.2	404	206.7	244.0
278	136.7	33.0	328	164.4	85.6	406	207.8	250.0
279	137.2	33.8	329	165.0	87.0	408	208.9	256.0
280	137.8	34.5	330	165.6	88.4	410	210.0	262.0
281	138.3	35.3	331	166.1	89.8	412	211.1	268.0
282	138.9	36.1	332	166.7	91.2	414	212.2	275.0
283	139.4	36.9	333	167.2	92.7	416	213.3	281.0
284	140.0	37.7	334	167.8	94.1	418	214.4	288.0
285	140.6	38.6	335	168.3	95.6	420	215.6	294.0

Pressure Conversions

100 PSI = 6.9 Bars  
 250 PSI = 17.25 Bars  
 600 PSI = 41.4 Bars

5 Bars = 72.5 PSI  
 10 Bars = 145 PSI  
 25 Bars = 362.5 PSI

Pressure - Temperature Ratings

- Ratings apply to all products covered by ANSI B16.5 valves conforming to the requirements of this standard must, in other respects, merit these ratings.
- All ratings are maximum allowable non-shock pressures (PSIG) at the tabulated temperatures (degree Fahrenheit). Temperatures are those on the inside of the pressure retaining structure.
- The use of these ratings requires gaskets conforming to the requirements of ANSI B16.5. The user is responsible for selecting gaskets of dimensions and materials to withstand the required bolt loading without injurious crushing, and suitable for the service conditions in all other respects.

Safety &  
Technical

Pressure Class	150	300
Test Pressure	425	1100
Service Temperature	Working Pressure	
-20 to 100	275	720
150	255	710
200	240	700
250	225	690
300	210	680
350	195	675
400	180	665
450	165	650
500	150	625
550	140	590
600	130	555
650	120	515
700	110	470
750	100	425

### Air Velocity in a Pipe

Using the equation and typical values of V, D and L explained to the right approximate values of P are computed as follows:

Safety & Technical

Velocity Ft / Sec	Pipe Diameter in Inches, 10' long				
	1	2	4	6	10
1	.0004	.0002	.0001	.00007	.00004
2	.0016	.0008	.0004	.00030	.00016
5	.0100	.0050	.0025	.00170	.0010
10	.0400	.0200	.0100	.00670	.0040
15	.0900	.0450	.0225	.01500	.0090
20	.1600	.0800	.0400	.02700	.0160
25	.2500	.1250	.0625	.04170	.0250
30	.3600	.1800	.0900	.06000	.0360

$$V = \sqrt{\frac{25,000 DP}{L}}$$

V = air velocity in feet per second  
 D = pipe inside diameter in inches  
 L = length of pipe in feet  
 P = pressure loss due to air friction in ounces/square inch

### Air Volume Discharged from Pipe

CFM = air volume in cubic feet per minute

V = air velocity in feet per second as determined in the equation at the top of this page

$$CFM = 60VA$$

A = cross section area of pipe in square feet

### Boyle's Law

If temperature is kept constant, the volume of a given mass of gas is inversely proportional to the pressure which is exerted upon it.

$$\frac{\text{Initial Pressure}}{\text{Final Pressure}} = \frac{\text{Final Volume}}{\text{Initial Volume}}$$

### Air Supply Requirements (operating pressure: 90 PSI)

Tool	Class	Typical Air Consumption (CFM)	Hose Size (inches)		
			0 - 10 ft.	10 - 50 ft.	50 - 200 ft.
Paving breakers	25 lb.	45	1/2"	1/2"	3/4"
	35 lb.	50	1/2"	3/4"	3/4"
	60 lb.	65	1/2"	3/4"	1"
	80 lb.	80	3/4"	3/4"	1"
Clay diggers		45	1/2"	1/2"	3/4"
Hand drills	8 lb.	20	3/8"	3/8"	1/2"
	15 lb.	32	3/8"	1/2"	1/2"
Rock (sinker) drills	45 lb.	105	3/4"	3/4"	1"
	55 lb.	130	3/4"	1"	1"
Tampers	5" butt	20	3/8"	1/2"	1/2"
	6" butt	30	1/2"	1/2"	3/4"
Sump pump	3 HP	100	3/4"	3/4"	1"
Sludge pump	Ejector	90	1"	1"	1"
Vibrators	2-1/2"	60	1"	1"	1"
	3"	60	1"	1"	1"
Chipping hammers		25	3/8"	1/2"	1/2"
Impact wrenches	3/8" sq. dr.	10	5/16"	3/8"	3/8"
	1/2"	15	5/16"	3/8"	1/2"
	3/4"	25	3/8"	1/2"	1/2"
	1"	50	1/2"	3/4"	3/4"
Drills	1/4" - 1/2"	22	3/8"	3/8"	1/2"
Grinders	die / burr	20	3/8"	3/8"	1/2"
	small angle	20	3/8"	3/8"	1/2"
	3 HP vertical	75	1/2"	3/4"	1"

## CFM vs PSI for Nozzles

- PSI = pounds/square inch
- CFM = cubic feet/minute

Gauge PSI	CFM Free Air Flow @ Nozzle Diameter (inches)							
	1/64	1/32	3/64	1/16	3/32	1/8	3/16	1/4
1	.03"	.11"	.2"	.4"	1.0"	1.7"	3.9"	6.8"
5	.06"	.24"	.5"	1.0"	2.2"	3.9"	8.7"	15.4"
10	.08"	.34"	.8"	1.4"	3.1"	5.4"	12.3"	21.8"
15	.10"	.42"	.9"	1.6"	3.7"	6.6"	15.0"	26.7"
20	.12"	.48"	1.1"	1.9"	4.2"	7.7"	17.1"	30.8"
25	.13"	.54"	1.2"	2.2"	4.7"	8.6"	19.4"	34.5"
30	.16"	.63"	1.4"	2.5"	5.6"	10.0"	22.5"	40.0"
40	.19"	.77"	1.7"	3.1"	6.8"	12.3"	27.5"	49.1"
50	.22"	.91"	2.0"	3.6"	8.2"	14.5"	32.8"	58.2"
60	.26"	1.05"	2.3"	4.2"	9.4"	16.8"	37.5"	67.0"
70	.29"	1.19"	2.7"	4.8"	10.7"	19.0"	43.0"	76.0"
80	.33"	1.33"	3.0"	5.3"	11.9"	21.2"	47.5"	85.0"
90	.36"	1.47"	3.3"	5.9"	13.1"	23.5"	52.5"	94.0"
100	.40"	1.61"	3.7"	6.4"	14.5"	25.8"	58.3"	103.0"
110	.43"	1.76"	3.9"	7.0"	15.7"	28.0"	63.0"	112.0"
120	.47"	1.90"	4.3"	7.6"	17.0"	30.2"	68.0"	121.0"
130	.50"	2.04"	4.6"	8.1"	18.2"	32.4"	73.0"	130.0"
140	.54"	2.17"	4.9"	8.7"	19.5"	34.5"	78.0"	138.0"
150	.57"	2.33"	5.2"	9.2"	20.7"	36.7"	83.0"	147.0"
175	.66"	2.65"	5.9"	10.6"	23.8"	42.1"	95.0"	169.0"
200	.76"	3.07"	6.9"	12.2"	27.5"	48.7"	110.0"	195.0"

Safety &  
Technical

## Air Receiver Capacities

Tank Size (inches)	Tank Size (gallons)	Gauge Pressure on Tank (PSI)			
		0	100	150	200
Cubic Feet Tank Capacity					
12 x 24	10	1.3	11	15	19
14 x 36	20	2.7	21	30	39
16 x 36	30	4.0	31	45	59
20 x 48	60	8.0	62	90	117
20 x 63	80	10.7	83	120	156
24 x 68	120	16.0	125	180	234
30 x 84	240	32.0	250	360	467

If your tank is not listed in the table to the left, use the following formula to calculate the tank size (gallons) and then estimate the cubic feet tank capacity at a given pressure from the table above.

$$\text{Tank Gallons} = \frac{\text{Tank Height} \times (\text{Tank Radius})^2}{73.53}$$

Height and Radius are in inches

## Air Hose Friction

- PSI = pressure in pounds/square inch
- CFM = air flow in cubic feet/minute

Safety &  
Technical

Hose Size (inches)	CFM thru 50' Hose	Gauge Pressure - Pounds/sq inch			
		50	70	90	110
PSI Loss Over 50' Hose Length					
½"	20	1.8	1.0	.8	.6
	30	5.0	3.4	2.4	2.0
	40	10.1	7.0	5.4	4.3
	50	18.1	12.4	9.5	7.6
	60	+	20.0	14.8	12.0
	70	+	28.4	22.0	17.6
	80	+	+	30.5	24.6
	90	+	+	41.0	33.3
	10	+	+	+	44.5
	110	+	+	+	+
¾"	20	.04	.2	.2	.1
	30	.08	.5	.4	.3
	40	1.5	.9	.7	.5
	50	2.4	1.5	1.1	.9
	60	3.5	2.3	1.6	1.3
	70	4.4	3.2	2.3	1.8
	80	6.5	4.2	3.1	2.4
	90	8.5	5.5	4.0	3.1
	100	11.4	7.0	5.0	3.9
	110	14.2	8.8	6.2	4.9
	120	+	11.0	7.5	5.9
	130	+	+	9.0	7.1
	1"	20	.1	0	0
30		.2	.1	.1	.1
40		.3	.2	.2	.2
50		.5	.4	.3	.2
60		.8	.5	.4	.3
70		1.1	.7	.6	.4
80		1.5	1.0	.7	.6
90		2.0	1.3	.9	.7
100		2.6	1.6	1.2	.9
110		3.5	2.0	1.4	1.1
120		4.8	2.5	1.7	1.3
130		7.0	3.1	2.0	1.5

+ pressure loss is too great and therefore the combination of hose size, CFM, and gauge pressure is not recommended. Gauge pressures the indicated air pressure in pounds/square inch, at the source (i.e. the air compressor receiver tank)



## Maximum Recommended Air Flow (SCFM) Through ANSI Standard Weight Schedule 40 Metal Pipe

- Flow values in the table below are based on a pressure drop of 10% of the applied pressure per 100 feet of pipe for 1/8", 1/4", 3/8", and 1/2" pipe sizes; and a pressure drop of 5% of the applied pressure per 100 feet of pipe for 3/4", 1", 1 1/4", 2", 2 1/2", 3" pipe sizes. The table gives recommended flows for pipe sizes at listed pressures and should be used to determine appropriate piping for air systems.

Applied Pressure PSI	Nominal Standard Pipe Size										
	1/8"	1/4"	3/8"	1/2"	3/4"	1"	1 1/4"	1 1/2"	2"	2 1/2"	3"
<b>5</b>	0.5	1.2	2.7	4.9	6.6	13	27	40	80	135	240
<b>10</b>	0.8	1.7	3.9	7.7	11.0	21	44	64	125	200	370
<b>20</b>	1.3	3.0	6.6	13.0	18.5	35	75	110	215	350	600
<b>40</b>	2.5	5.5	12.0	23.0	34.0	62	135	200	385	640	1100
<b>60</b>	3.5	8.0	18.0	34.0	50.0	93	195	290	560	900	1600
<b>80</b>	4.7	10.5	23.0	44.0	65.0	120	255	380	720	1200	2100
<b>100</b>	5.8	13.0	29.0	54.0	80.0	150	315	470	900	1450	2600
<b>150</b>	8.6	20.0	41.0	80.0	115.0	220	460	680	1350	2200	3900
<b>200</b>	11.5	26.0	58.0	108.0	155.0	290	620	910	1750	2800	5000
<b>250</b>	14.5	33.0	73.0	135.0	200.0	370	770	1150	2200	3500	6100

**Safety &  
Technical**

### Suggested Pipe Size for Compressed Air Flow at 100 PSI Length of Run, Feet

SCFM Air Flow	25	50	75	100	150	200	300	500	1000	Compressor HP
4	1/2	1/2	1/2	1/2	1/2	1/2	1/2	3/4	3/4	1
12	1/2	1/2	1/2	3/4	3/4	1/2	3/4	1	1	3
20	3/4	3/4	3/4	3/4	1	3/4	1	1 1/4	1 1/4	5
30	3/4	3/4	1	1	1	1	1 1/4	1 1/4	1 1/4	7 1/2
40	3/4	1	1	1	1 1/4	1	1 1/4	1 1/2	1 1/2	10
60	1	1	1 1/4	1 1/4	1 1/4	1 1/4	1 1/2	1 1/2	2	15
80	1	1 1/4	1 1/4	1 1/4	1 1/2	1 1/4	1 1/2	2	2	20
100	1 1/4	1 1/4	1 1/2	1 1/2	1 1/2	1 1/2	2	2	2 1/2	25
120	1 1/4	1 1/2	1 1/2	1 1/2	2	1 1/2	2	2 1/2	2 1/2	30
160	1 1/4	1 1/2	1 1/2	2	2	1 1/2	2 1/2	2 1/2	3	40
200	1 1/2	2	2	2	2	2	2 1/2	3	3	50
240	1 1/2	2	2	2	2 1/2	2	2 1/2	3	3	60
300	2	2	2	2 1/2	2 1/2	2	3	3	3 1/2	75
400	2	2 1/2	2 1/2	2 1/2	3	2 1/2	3	3 1/2	4	100
500	2	2 1/2	2 1/2	3	3	2 1/2	3 1/2	3 1/2	4	125

On a compressed air distribution system, pressure losses greater than 3% are considered excessive, and a well-designed system having a steady rate of air flow is usually designed for not more than a 1% loss or 1 PSI for a 100 PSI system. The pipe size depends not only on the volume of air flow but how far it must be carried. To hold the distribution loss to 1 PSI, pipes of larger diameter must be used on longer runs to carry the same flow that can be handled by smaller pipes on shorter runs.

Figures in the body of the chart above are pipe sizes recommended on a 100 PSI system to carry air with less than 1 PSI loss. When measuring lengths of runs, add 5' of length for each pipe fitting. If carrying 120 PSI pressure these sizes will carry slightly more air than shown, or pressure loss will be slightly less than 1 PSI. If carrying 80 PSI pressure these pipes will carry slightly less air at 1 PSI pressure loss than shown in the chart.

The left column of the chart shows the volume of air to be carried. It is difficult to estimate the air flow volume to be carried in each leg of the distribution system. This varies with the application. On some applications, like in a large plant with many legs in the distribution system serving dozens of air-operated machines, the air usage may be at a fairly steady rate. Other applications, usually on small systems, may have to carry a high surge of air if several machines happen to be operated at the same time. Then there may be a period with almost no flow.

To make a realistic estimate of air flow volume, the far right column of the chart showing compressor HP may be used. On steady pumping, a compressor will produce a minimum of 4 SCFM air flow for each 1 HP of capacity. This is a conservative figure, as most compressors will produce 5 or 6 SCFM.

For example, a 25 HP compressor will produce at least 100 SCFM of air as shown in the far left column on the same line as 25 HP.

excerpted from *Industrial Fluid Power*, Volume 1, third edition, 1984

## Water Constants and Formulas

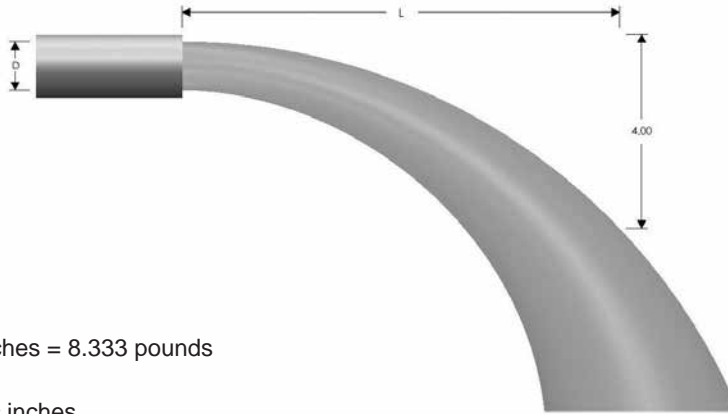

Safety & Technical

1 gallon water = 231 cubic inches = 8.333 pounds

1 pound of water = 27.7 cubic inches

1 cubic foot water = 7.5 gallons = 62.5 pounds (salt water weighs approximately 64.3 pounds per cubic foot)

Pounds per square inch at bottom of a column of water = height of column in feet x .434

1 miner's inch = 9 to 12 gallons per minute

Horsepower to raise water

If pumping liquid other than water, multiply the gallons per minute below by the liquids specific gravity

$$\text{Horsepower} = \frac{\text{gallons per minute} \times \text{total head in feet}}{3960}$$

Gallons per minute through a pipe

$$\text{GPM} = .0408 \times \text{pipe diameter inches}^2 \times \text{feet/minute water velocity}$$

Weight of water in a pipe

$$\text{Pounds water} = \text{pipe length feet} \times \text{pipe diameter inches}^2 \times .34$$

L Distance (inches)	Gallons per Minute Discharge for a Given Nominal Pipe Diameter D (inches)				
	5	6	8	10	12
5	163	---	---	---	---
6	195	285	---	---	---
7	228	334	580	---	---
8	260	380	665	1060	---
9	293	430	750	1190	1660
10	326	476	830	1330	1850
11	360	525	915	1460	2020
12	390	570	1000	1600	2220
13	425	620	1080	1730	2400
14	456	670	1160	1860	2590
15	490	710	1250	2000	2780
16	520	760	1330	2120	2960
17	550	810	1410	2260	3140
18	590	860	1500	2390	3330
19	620	910	1580	2520	3500
20	650	950	1660	2660	3700
21	685	1000	1750	2800	3890
22	720	1050	1830	2920	4060
23	750	1100	1910	3060	4250
24	---	1140	2000	3200	4440

## Water Discharge Table

This table is intended for general reference and general applicability only, and should not be relied upon as the sole or precise source of information available with respect to the subject covered. The user should also refer to and follow manufacturer's specific instructions and recommendations with regard to such information, where they exist.

### Flow of water through 100 foot lengths of hose, Straight - Smooth Bore - US gallons per minute

PSI at Hose Inlet	Nominal Hose ID Diameters - Inches							
	1"	1¼"	1½"	2"	2½"	3"	4"	6"
20	26	47	76	161	290	468	997	2895
30	32	58	94	200	360	582	1240	3603
40	38	68	110	234	421	680	1449	4209
50	43	77	124	264	475	767	1635	4748
60	47	85	137	291	524	846	1804	5239
75	53	95	154	329	591	955	2035	5910
100	62	112	180	384	690	1115	2377	6904
125	70	126	203	433	779	1258	2681	7788
150	77	139	224	478	859	1388	2958	8593
200	90	162	262	558	1004	1621	3455	10038

Figures are to be used as a guide since the hose inside diameter tolerance, the type of fittings used, and orifice restriction all influence the actual discharge. Thus, variations plus or minus from the table may be obtained in actual service.

## Conversion Table - Feet of Water to Inches of Mercury

Feet of Water	1	2	4	6	8	10	12	14	16	20	22	24	26	28	30	32	34
Inches of Mercury	0.9	1.8	3.5	5.3	7.1	8.8	10.6	12.4	14.1	17.7	19.4	21.2	23.0	24.8	26.5	28.3	30.0

## Feet Head of Water to PSI

- One foot of water at 62°F = 0.433 PSI, to find the PSI for any feet head not given in the table, multiply the feet head by 0.433.

Feet Head	Pounds per Square Inch
1	0.43
2	0.87
3	1.30
4	1.73
5	2.17
6	2.60
7	3.03
8	3.46
9	3.90
10	4.33
15	6.50
20	8.66
25	10.83
30	12.99
40	17.32
50	21.65
60	25.99
70	30.32
80	34.65
90	38.98
100	43.31
110	47.64
120	51.97
130	56.30
140	60.63
150	64.96
160	69.29
170	73.63
180	77.96
200	86.62
250	108.27
300	129.93
350	151.58
400	173.24
500	216.55
600	259.85
700	303.16
800	346.47
900	389.78
1000	433.00

## Pipe Threads

Pipe threads are either tapered or straight (parallel). The two styles may or may not be compatible. Refer to thread information chart on page 939.

Safety & Technical

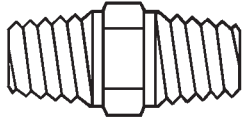

tapered threads

### Tapered threads

Tapered threads are the most common type of thread available. As the name implies, they have a slight taper. When mated together and tightened, the threads compress and may form a seal. Usually a thread sealant is required. The mating threads both hold the fitting in place and seal the connection. The most widely used pipe threads in North America are NPT (National Pipe Taper). Some confusion may result from the use of NPT, FPT, and MPT in describing threads. Both FPT and MPT are NPT threads, with FPT meaning female threads (internal) and MPT meaning male threads (external).

NPTF (Dryseal) threads are modified NPT threads, which are less likely to leak without a sealant. For a leak-free seal, we recommend using a sealant compound or PTFE tape. You can use NPTF threads with NPT threads, but you'll lose some of the leak-free characteristics.

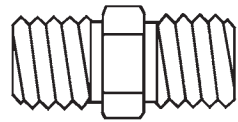

straight threads

### Straight threads

Straight (parallel) threads are used for mechanical joining. They serve one purpose - to hold a fitting in place. As a result, an O-ring (elastomer), hard metal seal or a soft seat seal is required. Straight pipe threads include NPSM (National Pipe Straight Mechanical), and NPSH (National Pipe Straight Hose). Sizing and pitches may differ from the NPT threads

Less common straight threads are GHT (Garden Hose) and NST (fire hose coupling).

## NPT vs. BSP (British Standard Pipe)

BSP threads are common in many countries outside the United States. BSP consists of two types of threads - BSPT (British Standard Pipe Taper) and BSPP (British Standard Pipe Parallel).

BSPT threads have a slight taper similar to NPT. BSPP threads are straight (parallel) threads and have the same thread angle, shape and threads per inch (pitch) as BSPT threads. *BSPT and BSPP threads should not be substituted for NPT threads.*

NPT and BSPT/BSPP threads have different angles, shape, and (in most cases) threads per inch (pitch). The thread angle is 60° for NPT threads; 55° for BSPT/BSPP threads. NPT threads are flattened at the peaks and valleys, while BSPT/BSPP threads are rounded.

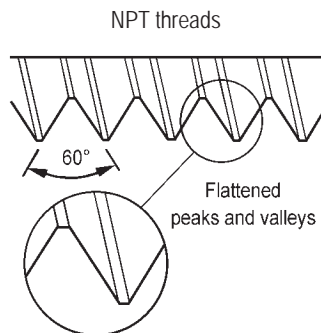
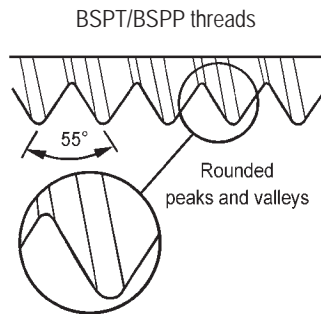

Nominal Pipe Size	Threads per inch	
	NPT	BSPT / BSPP
1/16"	27	---
1/8"	27	28
1/4"	18	19
3/8"	18	19
1/2"	14	14
3/4"	14	14
1"	11½	11
1-1/4"	11½	11
1-1/2"	11½	11
2"	11½	11
2-1/2"	8	11
3"	8	11
3-1/2"	8	11
4"	8	11
5"	8	11
6"	8	11
8"	8	11

## Identifying Threads

*It is important to identify the threads required before ordering couplings.*

Identifying threads can sometimes be the most difficult and frustrating part of coupling selection. However, without the right combination of threads, you may not provide a functional or safe connection.

The diameters, threads per inch (TPI) and thread pitch, etc. are necessary to completely identify a thread. Ring, plug and GO/NOGO gauges are required to accurately gauge or identify threads. In the field, in the absence of these gauges, thread leaf gauges can be used to identify the Threads Per Inch (TPI) and the thread pitch. On threads you have determined to be straight threads, a caliper can be used to measure the Outside Diameter of the male (ODM) or the Inside Diameter of the female (IDF). A caliper can also be used to take measurements of tapered thread diameters. However, these are more difficult to define because of the taper. Fortunately, there are few tapered threads to deal with and these can usually be identified from the nominal ODM and the TPI.

However, identifying the thread may not fully identify what is needed in a mating fitting. The application is the primary *limiting factor on the thread type used*. Dixon® offers products with a wide variety of threads used with hose, pipe and hydraulics.

When attempting to choose a fitting, it is always advisable to first identify the thread to which it must connect. This may entail checking with a fitting or equipment manufacturer.

*The fire hose thread specifications for some local municipal fire equipment and hydrants may vary according to local specifications. These can generally be most easily identified by contacting the local fire department responsible for the hydrant.* The most common thread used on fire equipment is National Standard Thread (NST), also known as National Hose thread (NH).

### When it is not possible to identify the thread:

1. Determine the number of threads per inch by measuring the distance from peak of thread to peak of thread across the largest number of whole threads. Then divide the number of threads by the measurement (this will provide the TPI).

2. Check to see if the thread is straight or tapered.

#### a) Straight Threads

Measure the Outside Diameter of the Male (ODM) or the Inside Diameter of the Female (IDF), from peak of thread to peak of thread.

#### b) Tapered Threads

Measure the Outside Diameter of the Male (ODM) at the large end and the small end, or the Inside Diameter of the Female (IDF) at the large end and the small end, from peak of thread to peak of thread. Then measure the Outside Diameter (OD) of the unthreaded pipe.

Once the application and these two pieces of information have been determined, the thread can generally be determined. When in doubt, call Dixon® at 800.355.1991.

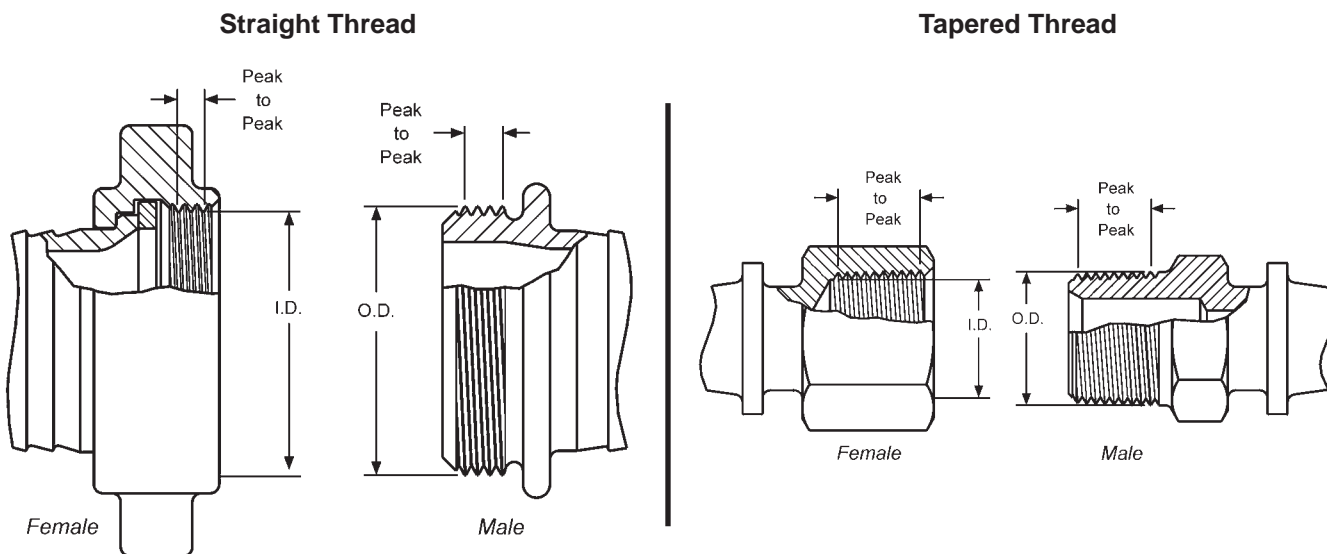

Abbreviation	System Name	Compatibility	Seal Method
<b>BSPP</b>	British Standard Pipe Parallel	male BSPP with female BSPP	washer
		female BSPP with male BSPP	washer
		female BSPP with male BSPT	washer
<b>BSPTTr</b>	British Standard Pipe Taper	male BSPTTr with female BSPTTr	thread
		male BSPTTr with female BSPP	washer
		female BSPTTr with male BSPTTr	thread
		<i>female BSPTTr not compatible with male BSPP</i>	
<b>CHT</b>	American Standard Fire Hose Thread (1" National Hose Thread is <b>C</b> hemical <b>H</b> ose <b>T</b> hread, also known as <b>B</b> ooster <b>H</b> ose <b>T</b> hread)	1" male NH (NST) with 1" female NH (NST)	washer
		1" female NH (NST) with 1" male NH (NST)	washer
		1" thread is used on both ¾" hose & 1" hose	not compatible
<b>GHT</b>	Garden Hose Thread	male GHT with female GHT	washer
		female GHT with male GHT	washer
		thread is same for all size hose	not compatible
<b>IPS</b>	Iron Pipe Straight Thread	generic name for Straight Pipe Thread <i>see NPSH for compatibility</i>	washer
<b>IPT</b>	Iron Pipe Thread	generic name for All Pipe Thread	more information required
<b>JIC</b>	Joint Industrial Committee	used with other mating JIC threads	mechanical
<b>NH or NST</b>	American Standard Fire Hose Coupling Thread ( <b>N</b> ational <b>H</b> ose thread also known as <b>N</b> ational <b>S</b> tandard <b>T</b> hread)	male NH (NST) with female NH (NST)	washer
		female NH (NST) with male NH (NST) thread pitch and diameters of fire threads may vary according to local and municipal regulations <i>not compatible with other systems</i>	washer
<b>NPT</b>	American Standard Taper Pipe Thread ( <b>N</b> ational <b>P</b> ipe <b>T</b> apered)	male NPT with female NPT	thread
		male NPT with female NPTF	thread
		male NPT with female NPSM	washer
		male NPT with female NPSH	washer
		female NPT with male NPT	thread
		female NPT with male NPTF <i>female NPT not compatible with male NPSM or male NPSH</i>	thread
<b>NPTF</b>	American Standard Taper Pipe Fuel Dryseal Thread ( <b>N</b> ational <b>P</b> ipe <b>T</b> apered <b>D</b> ryseal)	male NPTF with female NPTF	thread
		male NPTF with female NPT	thread
		male NPTF with female NPSM	washer
		male NPTF with female NPSH	washer
		female NPTF with male NPTF	thread
		female NPTF with male NPT	thread
		female NPTF with male NPSM or NPSH <i>NPTF with NPTF threads do not require sealant for the initial use, after that, sealant is required</i>	not compatible
<b>NPSH</b>	American Standard Straight Pipe for Hose Couplings ( <b>N</b> ational <b>P</b> ipe <b>S</b> traight <b>H</b> ose)	male NPSH with female NPSH	washer
		female NPSH with male NPSH	washer
		female NPSH with male NPT	washer
		female NPSH with male NPTF	washer
		female NPSH with male NPSM	washer
<b>NPSM</b>	American Standard Straight Mechanical Joints ( <b>N</b> ational <b>P</b> ipe <b>S</b> traight <b>M</b> echanical)	male NPSM with female NPSM	Seal can be either mechanical or washer. Mating fittings must be of same type.
		male NPSM with female NPSH	
		female NPSM with male NPSM	
		female NPSM with male NPT	
		female NPSM with male NPTF	
<b>SIPT</b>	Straight Iron Pipe Thread	generic name for Straight Pipe Thread	washer
<b>TIPT</b>	Tapered Iron Pipe Thread	generic name for Tapered Pipe Thread	thread
<b>NYFD</b>	NYFD Fire Department	straight thread used in New York City	washer
<b>Chicago</b>	Chicago Fire Department	straight thread used in Chicago	washer

Thread Chart for Hydraulic Fittings

Dash Size	2	4	6	8	10	12	16	20	24	32	40	48
JIC 37 degree Flare Thread	5/16-24	7/16-20	9/16-18	3/4-16	7/8-14	1 1/16-12	1 5/16-12	1 5/8-12	1 7/8-12	2 1/2-12	---	---
SAE O-ring Thread	---	7/16-20	9/16-18	3/4-16	7/8-14	1 1/16-12	1 5/16-12	1 5/8-12	1 7/8-12	2 1/2-12	---	---
NPTF Pipe Thread	1/8-27	1/4-18	3/8-18	1/2-14	---	3/4-14	1-11 1/2	1 1/4-11 1/2	1 1/2-11 1/2	2-11 1/2	---	---
NPSM Swivel Thread	---	1/4-18	3/8-18	1/2-14	---	3/4-14	1-11 1/2	1 1/4-11 1/2	1 1/2-11 1/2	2-11 1/2	---	---
Flat Face Thread	---	9/16-18	11/16-16	13/16-16	1-14	1 3/16-12	1 7/16-12	---	---	---	---	---
Code 61 Flange Head OD	---	---	---	1.19	---	1.50	1.75	2.00	2.38	2.81	3.31	4.0
Code 62 Flange Head OD	---	---	---	1.25	---	1.62	1.88	2.12	2.50	3.12	---	---
British Thread BSPP/BSPT	---	1/4-19	3/8-19	1/2-14	---	3/4-14	1-11	---	---	---	---	---

Safety & Technical

Fittings Size Chart

Male NPT Thread Sizes

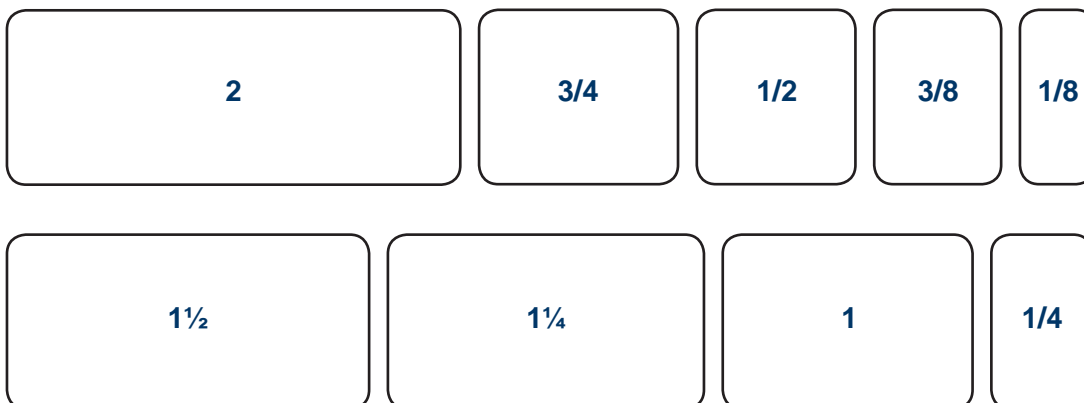

Male NST Thread Sizes

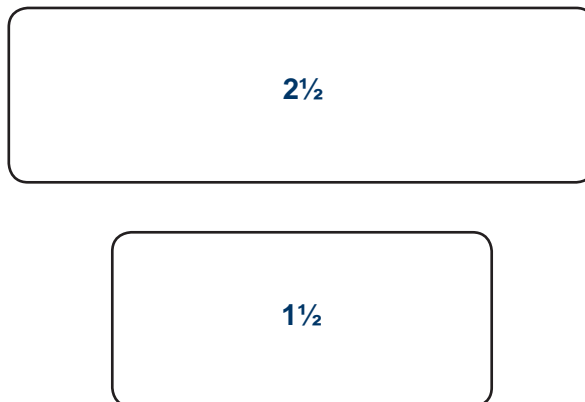

Thread Dimensions

Nominal Dimensions of Standard Threads

Safety & Technical

- ODM = Outside Diameter of the male
- IDF = Inside Diameter of the female
- TPI = Threads Per Inch
- GHT (3/4") -- 1.0625 ODM, 11-1/2 TPI
- Female NPT (Tapered Pipe) thread is not available on hose swivel nuts

Size	Pipe OD	Tapered Threads		Straight Threads											
		NPT	BSPT <sub>r</sub>	NPSH			NPSM			NST (NH)			BSPP		
		TPI	TPI	TPI	ODM (max)	IDF (min)	TPI	ODM (max)	IDF (min)	TPI	ODM (max)	IDF (min)	TPI	ODM (max)	IDF (min)
1/8"	.405	27.0	28				27.0	0.397	0.358					0.383	0.337
1/4"	.540	18.0	19				18.0	0.526	0.468					0.516	0.450
3/8"	.675	18.0	19				18.0	0.662	0.603					0.656	0.588
1/2"	.840	14.0	14	14.0	0.8248	0.7395	14.0	0.823	0.747					0.825	0.733
3/4"	1.050	14.0	14	14.0	1.0353	0.9500	14.0	1.034	0.958					1.041	0.950
1"	1.315	11.5	11	11.5	1.2951	1.1921	11.5	1.293	1.201	8.0	1.375	1.2246	11	1.309	1.193
1 1/4"	1.660	11.5	11	11.5	1.6399	1.5369	11.5	1.638	1.546				11	1.650	1.534
1 1/2"	1.900	11.5	11	11.5	1.8788	1.7758	11.5	1.877	1.785	9.0	1.990	1.8577	11	1.882	1.766
2"	2.375	11.5	11	11.5	2.3528	2.2498	11.5	2.351	2.259				11	2.347	2.231
2 1/2"	2.875	8.0	11	8.0	2.8434	2.6930	8.0	2.841	2.708	7.5	3.068	2.9104	11	2.960	2.844
3"	3.500	8.0	11				8.0	3.467	3.334	6.0	3.623	3.5306	11	3.460	3.344
4"	4.500	8.0	11				8.0	4.466	4.333	4.0	5.010	4.7111	11	4.450	4.334
4 1/2"										4.0	5.760	5.4611			
5"	5.563	8.0	11				8.0	5.528	5.395	4.0	6.260	5.9602	11	5.450	5.359
6"	6.625	8.0	11				8.0	6.585	6.452	4.0	7.025	6.7252	11	6.450	6.359
8"	8.625	8.0													
10"	10.750	8.0													
12"	12.750	8.0													

Normal Engagement Length of NPT Thread in Inches (A)

- Dimensions given do not allow for variations in tapping or threading.

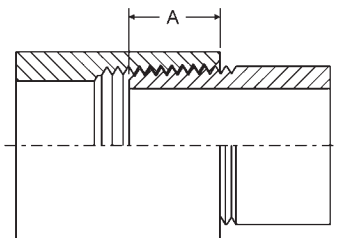

Thread Size	Dimension A
1/8"	1/4"
1/4"	3/8"
3/8"	3/8"
1/2"	1/2"
3/4"	9/16"
1"	11/16"
1-1/4"	11/16"
1-1/2"	11/16"
2"	3/4"
2-1/2"	15/16"
3"	1"
4"	1-1/8"
5"	1-1/4"
6"	1-5/16"
8"	1-7/16"
10"	1-5/8"
12"	1-3/4"



## Thread Sealing Tips

**Thread Sealing Tips**

Sealing NPT threads can be an exasperating experience if certain techniques are not followed. The following tips will help alleviate many common problems in thread sealing:

1. Always use some type of sealant (tape or paste) and apply sealant to male thread only. If using a hydraulic sealant, allow sufficient curing time before system is pressurized.
2. When using tape sealant, wrap the threads in a clockwise motion starting at the first thread and, as layers are applied, work towards the imperfect (vanishing) thread. If the system that the connection being made to cannot tolerate foreign matter (i.e. air systems), leave the first thread exposed and apply the tape sealant as outlined above.
3. When using paste sealant, apply to threads with a brush, using the brush to work the sealant into the threads. Apply enough sealant to fill in all the threads all the way around.
4. When connecting one stainless steel part to another stainless steel part that will require future disassembly, use a thread sealant that is designed for stainless steel (see page 787). This stainless steel thread sealant is also useful when connecting aluminum to aluminum that needs to be disconnected in the future. These two materials gall easily, and if the correct sealant is not used, it can be next to impossible to disassemble.
5. When connecting parts made of dissimilar metals (i.e. steel and aluminum), standard tape or paste sealant performs satisfactory.
6. For sizes 2" and below, tape or paste performs satisfactory. When using thread tape, four wraps (covering all necessary threads) is usually sufficient.
7. For sizes 2½" and above, thread paste is recommended. If thread tape is used, eight wraps (covering all necessary threads) is usually sufficient. Apply more wraps if necessary.
8. For stubborn to seal threads, apply a normal coating of thread paste followed by a normal layer of thread tape.
9. For extremely stubborn to seal threads, apply a normal coating of thread paste followed by a single layer of gauze bandage followed by a normal layer of thread tape.

**Caution!**

When this procedure is done, the connection becomes permanent. Extreme measures will be necessary to disconnect these components. *All other measures to seal the threads should be explored prior to use of this technique.*

10. Over-tightening threads can be just as detrimental as insufficient tightening. For sizes 2" and below, hand tighten the components and, with a wrench, tighten 3 full turns. For sizes 2½" and above, hand tighten the components and, with a wrench, tighten 2 full turns.

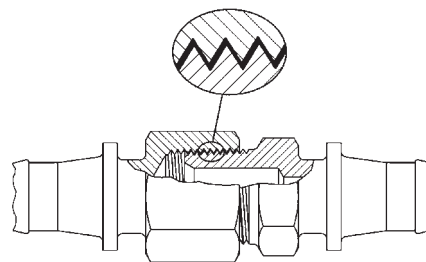
**Thread Seal Type**

- A seal is obtained by applying a sealant to the male thread before engaging.
- The sealant is used to prevent spiral leakage.
- Thread tape or paste is the preferred sealant in this type of application.
- Please refer to page 902 for thread tape options.

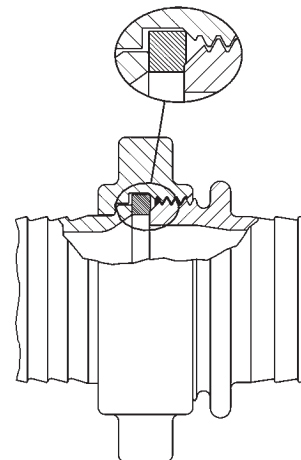
**Washer Seal Type**

- A seal is obtained when the male thread is tightened down onto the washer of the female assembly.
- The washer should be inspected regularly and replaced as needed to prevent leakage.
- Please refer to pages 72 and 40 for replacement washers.

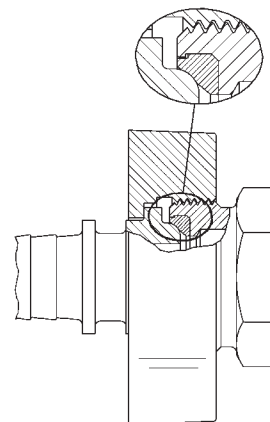
**Mechanical Seal Type**

- A seal is obtained through metal to metal contact or metal to seal contact, i.e. JIC couplings (page 511) have a metal to metal seal. Boss™ Ground Joint couplings (pages 67-69) have a metal to seal contact (shown above).
- The couplings should be retightened as needed to prevent leakage.

Flange Bolt Tightening Sequence

(Use appropriate gaskets and bolts)

Safety & Technical

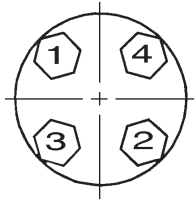

4 Bolt

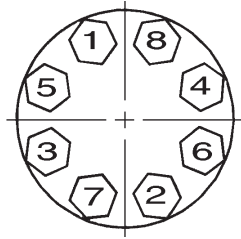

8 Bolt

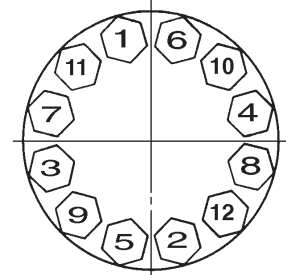

12 Bolt

See page 945 for drilling dimensions

Flange Diagrams

Threaded Applications

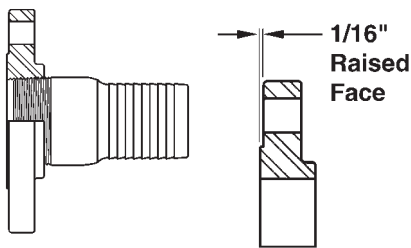

Threaded Flange with raised face

Welded Applications

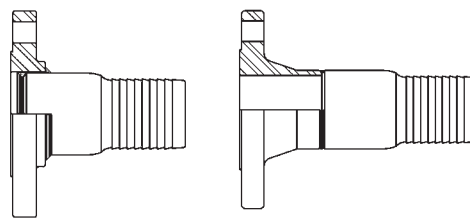

Slip-On Flange with raised face

Weld Neck Flange with raised face

Floating Applications  
(flange free to swivel)

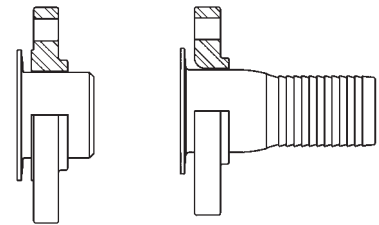

Slip-On Flange with raised face

Lap-Joint Flange

Dimensions of 150 LB. ASA Steel Flanges

Nominal Pipe Size	Flange OD	Thickness <sup>1</sup>	OD of Raised Face	Diameter of Bolt Circle	Number of Bolts	Diameter of Bolt Holes	Diameter of Bolts
1"	4-1/4"	9/16"	2"	3-1/8"	4	5/8"	1/2"
1-1/4"	4.62"	5/8"	2-1/2"	3-1/2"	4	5/8"	1/2"
1-1/2"	5"	11/16"	2-7/8"	3-7/8"	4	5/8"	1/2"
2"	6"	3/4"	3-5/8"	4-3/4"	4	3/4"	5/8"
2-1/2"	7"	7/8"	4-1/8"	5-1/2"	4	3/4"	5/8"
3"	7-1/2"	15/16"	5"	6"	4	3/4"	5/8"
4"	9"	15/16"	6-3/16"	7-1/2"	8	3/4"	5/8"
5"	10"	15/16"	7-5/16"	8-1/2"	8	7/8"	3/4"
6"	11"	1"	8-1/2"	9-1/2"	8	7/8"	3/4"
8"	13-1/2"	1-1/8"	10-5/8"	11-3/4"	8	7/8"	3/4"
10"	16"	1-3/16"	12-3/4"	14-1/4"	12	1"	7/8"
12"	19"	1 1/4"	15"	17"	12	1"	7/8"

<sup>1</sup> 1/16" raised face is included in the thickness

Dimensions of Tank Truck Flanges (TTMA Drilling)

Nominal Pipe Size	Flange OD	Thickness <sup>1</sup>	Diameter of Bolt Circle	Number of Bolts	Diameter of Bolt Holes	Diameter of Bolts
3"	5-5/8"	3/8"	4-7/8"	8	7/16"	3/8"
4"	6-5/8"	3/8"	5-7/8"	8	7/16"	3/8"
6"	8-7/8"	3/8"	8-1/8"	12	7/16"	3/8"

<sup>1</sup> listed thickness is for aluminum flanges

ANSI Flange Dimensions

150 lb. Standard

Nominal Pipe Size	Outside Diameter Flange	Flange Thickness	Drill Template		
			Number Holes	Diameter Bolts	Bolt Circle
1/2"	3-1/2"	7/16"	4	1/2"	2-3/8"
3/4"	3-7/8"	1/2"	4	1/2"	2-3/4"
1"	4-1/4"	9/16"	4	1/2"	3-1/8"
1-1/4"	4-5/8"	5/8"	4	1/2"	3-1/2"
1-1/2"	5"	11/16"	4	1/2"	3-7/8"
2"	6"	3/4"	4	5/8"	4-3/4"
2-1/2"	7"	7/8"	4	5/8"	5-1/2"
3"	7-1/2"	15/16"	4	5/8"	6"
3-1/2"	8-1/2"	15/16"	8	5/8"	7"
4"	9"	15/16"	8	5/8"	7-1/2"
5"	10"	15/16"	8	3/4"	8-1/2"
6"	11"	1"	8	3/4"	9-1/2"
8"	13-1/2"	1-1/8"	8	3/4"	11-3/4"
10"	16"	1-3/16"	12	3/4"	14-1/4"
12"	19"	1-1/4"	12	3/4"	17"

300 lb. Standard

Nominal Pipe Size	Outside Diameter Flange	Flange Thickness	Drill Template		
			Number Holes	Diameter Bolts	Bolt Circle
1/2"	3-3/4"	9/16"	4	1/2"	2-5/8"
3/4"	4-5/8"	5/8"	4	5/8"	3-1/4"
1"	4-7/8"	11/16"	4	5/8"	3-1/2"
1-1/4"	5-1/4"	3/4"	4	5/8"	3-7/8"
1-1/2"	6-1/8"	13/16"	4	3/4"	4-1/2"
2"	6-1/2"	7/8"	8	5/8"	5"
2-1/2"	7-1/2"	1"	8	3/4"	5-7/8"
3"	8-1/4"	1-1/8"	8	3/4"	6-5/8"
3-1/2"	9"	1-3/16"	8	3/4"	7-1/4"
4"	10"	1-1/4"	8	3/4"	7-7/8"
5"	11"	1-3/8"	8	3/4"	9-1/4"
6"	12-1/2"	1-7/16"	12	3/4"	10-5/8"
8"	15"	1-5/8"	12	7/8"	13"
10"	17-1/2"	1-7/8"	16	1"	15-1/4"
12"	20-1/2"	2"	16	1-1/8"	17-3/4"

600 lb. Standard

Nominal Pipe Size	Outside Diameter Flange	Flange Thickness	Drill Template		
			Number Holes	Diameter Bolts	Bolt Circle
1/2"	3-3/4"	9/16"	4	5/8"	2-5/8"
3/4"	4-5/8"	5/8"	4	3/4"	3-1/4"
1"	4-7/8"	11/16"	4	3/4"	3-1/2"
1-1/4"	5-1/4"	13/16"	4	3/4"	3-7/8"
1-1/2"	6-1/8"	7/8"	4	7/8"	4-1/2"
2"	6-1/2"	1"	8	3/4"	5"
2-1/2"	7-1/2"	1-1/8"	8	7/8"	5-7/8"
3"	8-1/4"	1-1/4"	8	7/8"	6-5/8"
3-1/2"	9"	1-3/8"	8	1"	7-1/4"
4"	10-7/5"	1-1/2"	8	1"	8-1/2"
5"	13"	1-3/4"	8	1-1/8"	10-1/2"
6"	14"	1-7/8"	12	1-1/8"	11-1/2"
8"	16-1/2"	2-3/16"	12	1-1/4"	13-3/4"
10"	20"	2-1/2"	16	1-3/8"	17"
12"	22"	2-5/8"	20	1-3/8"	19-1/4"

900 lb. Standard

Nominal Pipe Size	Outside Diameter Flange	Flange Thickness	Drill Template		
			Number Holes	Diameter Bolts	Bolt Circle
1/2"	4-3/4"	7/8"	4	7/8"	3-1/4"
3/4"	5-1/8"	1"	4	7/8"	3-1/2"
1"	5-7/8"	1-1/8"	4	1"	4"
1-1/4"	6-1/4"	1-1/8"	4	1"	4-3/8"
1-1/2"	7"	1-1/4"	4	1-1/8"	4-7/8"
2"	8-1/2"	1-1/2"	8	1"	6-1/2"
2-1/2"	9-5/8"	1-5/8"	8	1-1/8"	7-1/2"
3"	9-1/2"	1-1/2"	8	1"	7-1/2"
3-1/2"	11-1/2"	1-3/4"	8	1-1/4"	9-1/4"
4"	13-3/4"	2"	8	1-3/8"	11"
6"	15"	2-3/16"	12	1-1/4"	12-1/2"
8"	18-1/2"	2-1/2"	12	1-1/2"	15-1/2"
10"	21-1/2"	2-3/4"	16	1-1/2"	18-1/2"
12"	24"	3-1/8"	20	1-1/2"	21"

Safety & Technical

Dimensions of Seamless and Welded Steel Pipe  
ASA-B36.10 and B36.19

Safety & Technical

Nominal Pipe Size	OD (inches)	Pipe Schedule Wall Thickness												
		10	20	30	Stand.	40	60	Extra Strong	80	100	120	140	160	XXX Strong
1/8"	0.405	0.049	---	---	0.068	0.068	---	0.095	0.095	---	---	---	---	---
1/4"	0.540	0.065	---	---	0.088	0.088	---	0.119	0.119	---	---	---	---	---
3/8"	0.675	0.065	---	---	0.091	0.091	---	0.126	0.126	---	---	---	---	---
1/2"	0.840	0.083	---	---	0.109	0.109	---	0.147	0.147	---	---	---	0.188	0.294
3/4"	1.050	0.083	---	---	0.113	0.113	---	0.154	0.154	---	---	---	0.219	0.308
1"	1.315	0.109	---	---	0.133	0.133	---	0.179	0.179	---	---	---	0.250	0.358
1 1/4"	1.660	0.109	---	---	0.140	0.140	---	0.191	0.191	---	---	---	0.250	0.382
1 1/2"	1.900	0.109	---	---	0.145	0.145	---	0.200	0.200	---	---	---	0.281	0.400
2"	2.375	0.109	---	---	0.154	0.154	---	0.218	0.218	---	---	---	0.344	0.436
2 1/2"	2.875	0.120	---	---	0.203	0.203	---	0.276	0.276	---	---	---	0.375	0.552
3"	3.500	0.120	---	---	0.216	0.216	---	0.300	0.300	---	---	---	0.438	0.600
3 1/2"	4.000	0.120	---	---	0.226	0.226	---	0.318	0.318	---	---	---	---	---
4"	4.500	0.120	---	---	0.237	0.237	---	0.337	0.337	---	0.438	---	0.531	0.674
5"	5.563	0.134	---	---	0.258	0.258	---	0.375	0.375	---	0.500	---	0.625	0.750
6"	6.625	0.134	---	---	0.280	0.280	---	0.432	0.432	---	0.562	---	0.719	0.864
8"	8.625	0.148	0.250	0.277	0.322	0.322	0.406	0.500	0.500	0.594	0.719	0.812	0.906	0.873
10"	10.750	0.165	0.250	0.307	0.365	0.365	0.500	0.500	0.594	0.719	0.844	1.000	1.125	1.000
12"	12.750	0.180	0.250	0.330	0.375	0.406	0.562	0.500	0.688	0.844	1.000	1.125	1.312	1.000

**Definitive Cross-Reference from NPS to DN Specification Sizes**

Nominal Pipe Size	DN	OD (inches)	Pipe Schedule Wall Thickness													
			5S	5	10S	10	20	30	40S	40	60	80S	80	100	120	160
1/8"	6	0.405	---	0.035	---	0.049	---	0.057	---	0.068	---	---	0.095	---	---	---
1/4"	8	0.540	---	0.049	---	0.065	---	0.073	---	0.088	---	---	0.119	---	---	---
1/2"	15	0.840	---	0.065	---	0.083	---	0.095	---	0.109	---	---	0.147	---	0.170	0.188
3/4"	20	1.050	---	0.065	---	0.083	---	0.095	---	0.113	---	---	0.154	---	0.170	0.219
1"	25	1.315	---	0.065	---	0.109	---	0.114	---	0.133	---	---	0.179	---	0.200	0.250
1 1/4"	32	1.660	---	0.065	---	0.109	---	0.117	---	0.140	---	---	0.191	---	0.215	0.250
1 1/2"	40	1.900	---	0.065	---	0.109	---	0.125	---	0.145	---	---	0.200	---	0.225	0.281
2"	50	2.375	---	0.065	---	0.109	---	---	---	0.154	---	---	0.218	---	0.250	0.344
2 1/2"	65	2.875	---	0.083	---	0.120	---	---	---	0.203	---	---	0.276	---	0.300	0.375
3"	80	3.500	---	0.083	---	0.120	---	---	---	0.216	---	---	0.330	---	0.350	0.438
4"	100	4.500	---	0.083	---	0.120	---	---	---	0.237	0.281	---	0.377	---	0.437	0.531
5"	125	5.563	---	0.109	---	0.134	---	---	---	0.258	---	---	0.375	---	0.500	0.625
6"	150	6.625	---	0.109	---	0.134	---	---	---	0.280	---	---	0.432	---	0.562	0.719
8"	200	8.625	---	0.109	---	0.148	0.250	0.277	---	0.322	0.406	---	0.500	0.593	0.718	0.906
10"	250	10.750	0.134	0.134	0.165	0.165	0.250	0.307	0.365	0.365	0.500	0.500	0.593	0.718	0.843	---
12"	300	12.750	0.156	0.165	0.180	0.180	0.250	0.330	0.375	0.406	0.500	0.500	0.687	0.843	1.000	---

## Valve Selection Guide

## Ball Valve

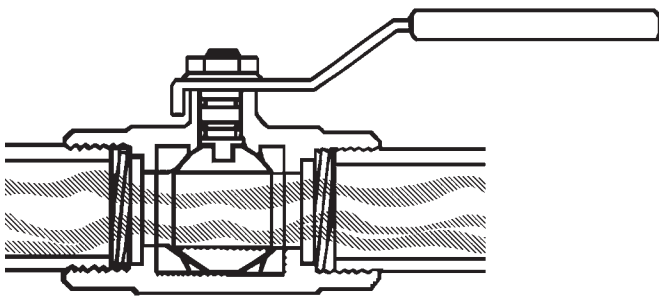

- can be used for on and off service or throttling
- when positive shut-off is necessary
- where a low valve profile is necessary
- only 90° rotation from open to fully closed (quick opening)
- Handle position is a quick indication of whether valve is open or closed.
- full port ball valves do not resist flow

Safety &  
Technical

## Butterfly Valve

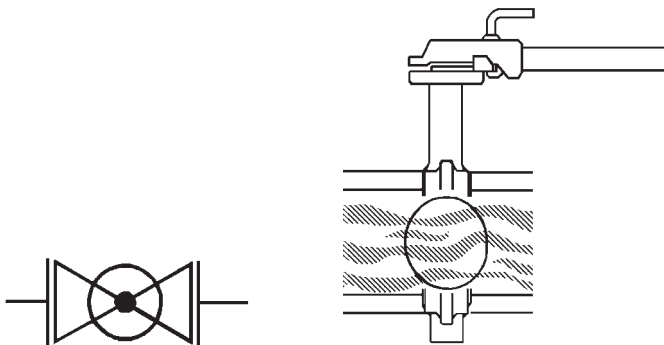

- where positive shut-off is necessary
- primarily for fully open or fully closed applications
- may be used for throttling
- only 90° rotation from open to fully closed
- lightweight
- easy to install
- less costly than an iron body gate valve

## Gate Valve

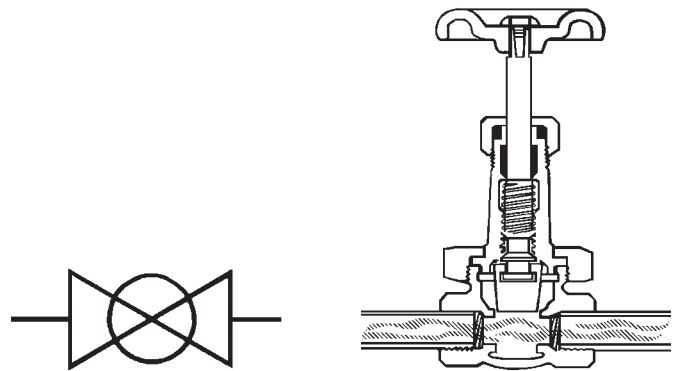

- for fully open or fully closed service - not for throttling
- for minimum line pressure drop
- for minimum fluid entrapment in the line
- for relatively infrequent operation

## Check Valve

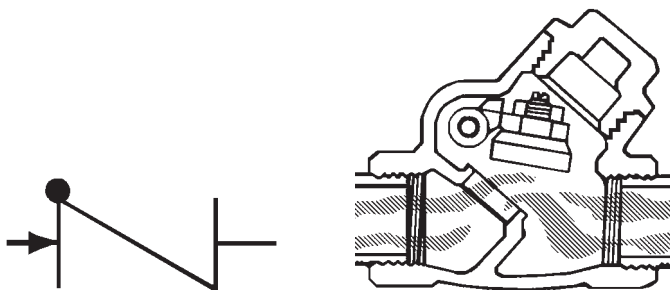

- To control the direction of flow and for quick, automatic reactions to flow change. Swing check valves are used when a minimum resistance to flow is required.
- Swing check valves are recommended for use in conjunction with gate valves. They should not be used in a rapid recycling system such as reciprocating pumps or air compressor service where they could cause chatter and damaging vibration.

## Globe Valve

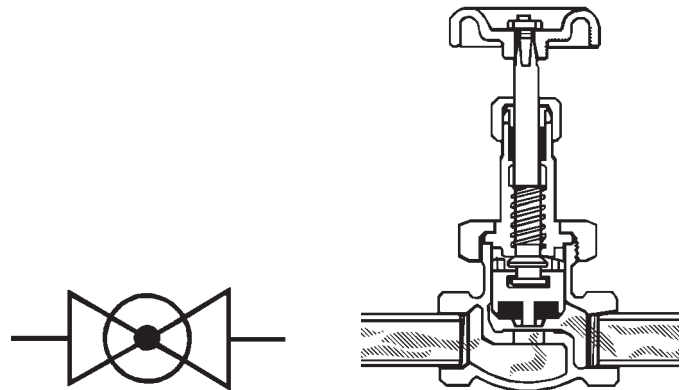

- for regulation (throttling) of flow
- for frequent operation; short stem travel reduces operator's time
- where some line resistance is acceptable

3-Way Ball Valve Flow Options

'T' Pattern, Side Entry

Top view

Safety & Technical

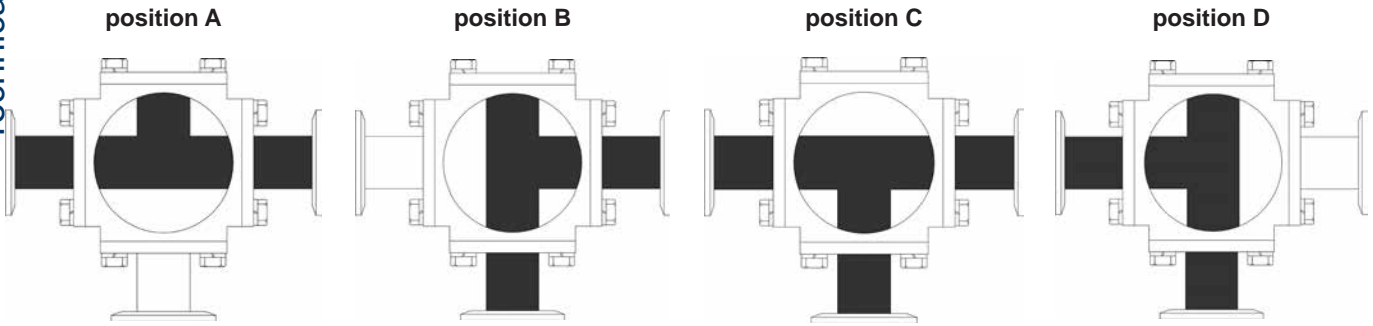

Number	Rotation	Flow Plan Options
1	90°	A, B
2	90°	B, C
3	90°	C, D
4	90°	A, D
5	180°	A, B, C
6	180°	B, C, D
7	180°	A, C, D
8	180°	A, B, D

'L' Pattern, Side Entry

Top view

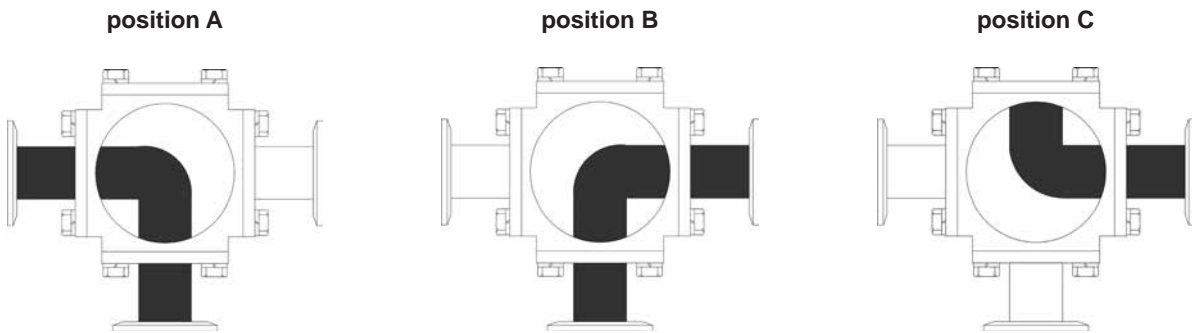

Number	Rotation	Flow Plan Options
1	90°	A, B
2	180°	A, B, C

Page #	Air (cont.)	Page #	Page #
<b>A</b>			<b>B</b>
Abrasion resistant inserts ..... 131, 134, 172	Gauges, process ..... 437		Back flow preventer ..... 245
Adapters	Hose, polyurethane ..... 891		Ball
Aviation ..... 16	Hose reel, manual ..... 882		Cone check valves ..... 558
Ball seat ..... 663	Hose reel, retractable ..... 881, 882		Mini
Bayonet style dry disconnect ..... 9	Hose, self-storing ..... 890, 891		Valves ..... 537
Boss™ ..... 70	Hose, spring driven ..... 881		Swivel connector
Boss™ LPS	Receiver manifold, ASME ..... 365		with Air Chief plugs ..... 301
Flanged ..... 82, 83	with King™ Safety Whipsock ..... 364		Swivels ..... 447
Flanged, 45° elbow ..... 82	with Watts filter ..... 366		Valves
Flanged, short ..... 82	Tool lubricant ..... 367		3-piece
Flanged, straight ..... 82	Air Chief		FNPT ..... 541
Flanged to male NPT, 125# ..... 83	ARO ..... 308, 309		Socket weld ..... 541
Flanged to weld, 150# ..... 83	Automotive ..... 306, 307		3-way
Cam and groove ..... 7, 33, 41, 109, 128,	Ball swivel connectors		L flow ..... 538
129, 131, 142-145, 150, 152-156, 160-	with Air Chief plugs ..... 301		T flow ..... 538
162, 174, 178, 180, 181, 183, 184, 186	Blow guns ..... 371		150# flanged ..... 545
Drum thread ..... 562	Industrial ..... 300-303		Bronze ..... 532-534
Dry disconnect ..... 7, 8, 12	Lincoln ..... 310		with NPT tap for drain ..... 534
Mann tek ..... 12, 14, 16	Quick disconnect ..... 300, 301, 303		Band clamp
Dry gas ..... 14	Stainless steel ..... 300, 301, 303		Band and buckle ..... 270
Fill pipe ..... 46	Air King™ ..... 366		Set screw ..... 270
GHT ..... 239-241	Clamps ..... 288		Tools ..... 272
Gravity drop ..... 29	Compressor Y ..... 367		F series ..... 267
Hydraulic	Ferrules ..... 287, 288		K series ..... 268
BSPP (British thread) ..... 523	Global ..... 285, 286, 288		Smooth ID ..... 269
Code 61 / Code 62 ..... 524-526	Lanyards ..... 289		Tools ..... 271
Flat face ..... 506, 507	Safety clip ..... 289		Tote ..... 270
JIC ..... 509-516	Safety pin ..... 289		Barbed push-on fittings ..... 306, 307
NPTF ..... 506, 508, 509, 511-514,	Washers ..... 289		Bayonet style dry disconnects ..... 9
518-522	with ferrules ..... 287		Bell reducers ..... 654, 655, 697
ORB ..... 506, 508-510	with gauge port ..... 287		Bent stem swivels ..... 329
Inserts ..... 131, 172	Air line		Blow guns
LIQUIfit™ ..... 727	Shut-off valves ..... 403, 559, 560		Air Chief ..... 371
LP gas ..... 704, 705	Swivels ..... 447		Extended nozzle ..... 372
Oxy-acetylene ..... 914	Air tool lubricants ..... 367		Extensions ..... 373, 374
Pump ..... 659	ANSI split flange adapter ..... 697		High volume ..... 374, 375
Reducing ..... 697	Anti-freeze lubricant ..... 367		Non-safety ..... 372, 373
Side seal ..... 44	API		Pistol grip ..... 372
Steam service ..... 13	Certified couplings ..... 97		Premium ..... 371
Tank car ..... 58	Coupler ..... 28		Safety ..... 371, 374
Tank transport ..... 41	Dust cap ..... 29		Safety air booster ..... 371
Tank truck ..... 35, 36, 43	FloTech™ ..... 32		Tips ..... 372, 373
Male adapter ..... 42	Rack cords ..... 31		Typhoon ..... 375
Tuff-Lite™ ..... 250, 673	Valves ..... 28		Bolted fittings ..... 678
Vapor recovery ..... 33, 46	ARO-speed quick disconnects ..... 308, 309		Gaskets ..... 678
Weld end metal hose fittings ..... 517	ASME air receiver manifold ..... 364-366		Boss-Lock™
with grounding tab ..... 30	Automatic		Cam and groove ..... 108, 135-137, 140,
Adjustable hose bumper stops ..... 882	Drain ..... 400		141, 147, 148, 154, 163-165, 171-173
Aero-seal® ..... 264, 265	Safety couplers ..... 305		EZ Boss-Lock™ 108, 133, 137, 141, 148
Agricultural	Automotive quick disconnects ..... 306, 307,		Boss™
Bauer quick connects ..... 257-261	316, 317		Adapters ..... 70
Air	Aviation, dry couplings ..... 15, 16		Clamps ..... 75, 76
Blow guns ..... 371-375	Axe ..... 911		Double spuds ..... 69, 77
Check valves ..... 559, 560	Axial restraint pipe couplings ..... 686		Female spuds ..... 68, 77
Couplings ..... 286, 290, 291, 293-299			Fittings with ferrules ..... 69

	Page #		Page #		Page #
<b>Boss™ (cont.)</b>		<b>Brass (cont.)</b>		<b>Cam and Groove (cont.)</b>	
Ground joint air hammer couplings ...	77	Male hose x male hose x female pipe	239	Caps	
Ground joint seal couplings .....	110	Pipe cap - NPT .....	671	Lockable .....	147
Hose menders .....	74	Pipe nipples .....	661	Clips and lanyards .....	289
Knurled nut .....	68	Reducer bushings - NPT .....	659	Couplers .... 6, 33, 34, 36, 108, 109, 126,	
Male spuds .....	69, 77	Reducer couplers - NPT .....	655	128, 129, 132-141, 151, 154, 160, 163,	
Male stems .....	73, 74	Long shank fittings .....	202	164, 175-177, 180-185, 188	
Spud x hose shank .....	74	LP gas hose couplings and adapters ....	704	150# flange .....	160
Stems		Male swivel inserts .....	211	Coupler x 150# flange .....	160
Ground joint .....	67	Nickel plated push-in fittings .... 348-352,	354	Coupler x adapter wye .....	164
Ground joint air hammer .....	77	Nylon/nickel-plated push-in fittings .....	350-353	Coupler x tube with 45° cut .....	163
Washer seal .....	71	Push-in fittings .....	342-345	Coupler x adapter .....	152
Washers .....	72	Push-on fittings .....	223-230	with Port .....	152, 153
Wing nut caps .....	70	Reusable fittings .....	231-233	Crimped fittings .....	109, 111-115
Wing nuts .....	68, 77	Sash chains with pull rings .....	171	Crimp sleeves .....	111, 112
<b>Boss™ LPS</b>		Short shank fittings .....	198, 199	Disk strainers .....	171
Adapters .....	82, 83	Swivels .....	211, 213, 216, 217, 223,	Dry disconnect .....	6, 7
45° elbow .....	82	225-229, 232, 234, 235, 241, 247		Dust caps .. 127, 129, 146-148, 179, 187	
Short .....	82	Tees . 331, 334, 335, 339, 344, 345, 349,	352, 359, 360, 668, 670	Locking handles for Dixon® cam &	
Straight .....	82	Threaded bell reducers .....	654, 655	groove dust caps .....	165
Caps .....	81	Threaded unions .....	657	Dust plugs .....	128, 129, 149, 179, 187
Complete assembly .....	78	Water regulators .....	378, 415	Elbows	
Female fittings .....	78	Break-away coupling		45° adapter x coupler .....	157
Ferrules .....	79	Industrial .....	18	45° coupler x coupler .....	157
Hammer union caps and plugs .....	81	Marine .....	17	90° adapter x coupler .....	157
Hammer union elbows .....	83	Breather vents .....	448	90° coupler x coupler .....	157
Male fittings .....	79	Bulkhead fittings .....	677	90° type A adapter x female NPT ....	
One-piece flange adapters .....	82, 83	Bull plugs .....	680	157	
One-piece hammer union nuts .....	80	Butterfly valves .....	39	90° type B coupler x male NPT . 158	
O-rings .....	79			90° type D coupler x female NPT ....	
Plugs .....	81			158	
Suction service fittings .....	79			90° type E adapter x hose shank ....	
Two-piece hammer union nuts .....	80			159	
Vent-lock™ cam and groove .....	128			90° type F adapter x male NPT . 159	
<b>Brass</b>				EZ Boss-Lock™ 128-130, 133, 136-138,	
Ball valves .....	535, 536			141, 148, 151, 153, 160, 161, 166	
Barbed hose fittings .. 211-217, 223-229,	248, 306, 307			EZLink™ armless .....	126, 127
<b>Boss™</b>				Flanged .....	160, 181
Clamps .....	75, 76	<b>C</b>		ANSI .....	182
Male stems .....	73	Cable junction box .....	65	Flanged couplers and adapters .. 35, 36,	
Combination nipples .....	190, 191	Cables		56	
Connectors .....	330, 332, 335, 336, 342,	King™ .....	362, 364	Gaskets .....	37, 59, 167-171
348, 350, 358-360		Spillguard™ armored .....	64	Global .....	109, 174-182
Crimper tools .....	220-222	Cam and groove		Handles	
Dies .....	219, 221, 222	150# flange .....	160	Boss-Lock™ .....	165
Dual lock .....	297-299	Abrasion resistant inserts 131, 134, 172		Dixon® .....	165
Elbows .... 330, 333, 337, 338, 343, 344,	349, 351, 353, 358, 360	Actuator style .....	8	EZ Boss-Lock™ handles .....	166
Ferrules .....	218, 233	Adapters .....	33, 35, 36, 43,	Global .....	182
Garden hose fittings .. 234-237, 239-242		44, 58, 109, 110, 128, 129, 131, 142, 143,	145, 150, 154, 160, 174, 178, 180, 181,	Paddle .....	166
Gauges .....	437, 443	183, 184		Vent-lock™ .....	130
Hex plugs .....	672	150# ANSI flange .....	160	Inlets .....	42
Jack chains with S-hooks .....	172	Adapter x 150# flange .....	160	In-Line sight glasses .....	163
<b>Lead free fittings</b>		Adapter x female NPSM .....	164	Jump size . 152, 153, 155, 156, 180, 181	
Adapters - NPT .....	655, 659	ANSI .....	182	King Crimp™ system .....	123
Female hex couplings - NPT .... 657		Boss-Lock™ .... 133, 135, 136, 140, 147,	153, 154, 163-165, 172, 173	Working pressures .....	123
		Boss™ LPS .....	128	Locking caps .....	147



	Page #		Page #		Page #
<i>Cam and Groove (cont.)</i>		<i>Clamp fittings (cont.)</i>		<i>Compression fittings (cont.)</i>	
Pull ring .....	171	cross hole wing nut .....	566	Connectors .....	711, 712
Rail car unloading assemblies .....	58	eye bolt .....	566	Elbows .....	713, 714
Reducing		hex wing nut .....	566	Inserts .....	715
Adapter x female NPT .....	155	mini cross hole wing nut .....	566	Nuts .....	716
Adapter x hose shank .....	156	rivet pin .....	566	Plug .....	715
Adapter x male NPT .....	156	serrated wing nut .....	566	Reducers .....	712
Coupler x female NPT .....	156	stainless steel hex nut .....	566	Sleeves .....	715, 716
Coupler x hose shank .....	155	Clamps .....	527-530	Tank fittings .....	713
Coupler x male NPT .....	155	Accessories .....	270, 271	Tees .....	714, 715
Reducing cplrs. & adps. ....	180	Aero-Seal® .....	264, 265	Compressor Y valve .....	367
Specialty items .....	35	Air King™ .....	288	Conical mufflers/filters .....	448
Spool adapters .....	154, 180	Band .....	267, 268	Connectors	
Swaged .....	138, 143	Band & buckles system .....	270, 272	Instrumentation .....	707
Tank car fittings .....	56-59	Bolted .....	276-280, 527	Connectors, push-in .....	330-335, 342-349, 352, 354
TTMA slip on x socket flange .....	35	Boss™ .....	75, 76	Constant torque clamps .....	266
Vapor recovery couplers .....	33, 34	Center punch .....	267, 269	Contractor pressure gauges .....	439
Velcro straps .....	172	Constant torque .....	266	Couplers	
Vent-Lock™ .....	128-130	Double bolt .....	279, 527	API .....	28
Weld fittings		HTM hi torque .....	266	Bayonet style dry disconnect .....	9
Butt .....	161, 162	Hydraulic .....	528	Cam and groove .....	126, 128, 132-141, 151-156, 160-162, 175
Socket .....	161, 162	Kits .....	275	Abrasion resistant inserts .....	134
Witches hat strainers .....	171	Painted iron .....	695	Cam and groove actuator style .....	8
Caps		Gaskets .....	695	Dry disconnect .....	6
ADS outalarm .....	65	Pinch-on .....	273, 274	Mann tek .....	11-18
Aluminum .....	40, 41	Racks .....	275	Garden hose .....	243
ANSI with tapped outlet .....	699	Roll over type .....	269	Legris .....	305
API, dust .....	29	Service kit .....	274	Parker E-z-mate .....	304
Blank end .....	699	Single bolt .....	280	Tank truck .....	36, 43
Boss™ wing nut .....	70	Smooth ID .....	269	Female coupler .....	42
Dust .....	9, 12, 16, 45	Spiral .....	281	NPT .....	42
Fill pipe .....	48	Stepless ear .....	274	Vapor recovery .....	33, 34
Flat face .....	507	T-bolt .....	276-278	with grounding tab .....	30
Gravity drop adapters .....	30	Tools .....	271, 272, 274	Coupling	
Hammer union .....	81	Wave seal .....	265	Inserter .....	904
Instrumentation .....	710	Worm gear		Lubricant .....	908
Lok-on .....	230	Aero-Seal® .....	264, 265	Couplings	
LP gas .....	706	Constant torque .....	266	Agri-Lock style .....	253-256
N-series .....	295	Dixon® .....	263	Air King™ universal .....	283-289
Nylon .....	676	HTM hi torque .....	266	A-series .....	326, 327
Pipe .....	671, 676	Make-a-clamp kits .....	275	Bauer style .....	257-261
Tank transport .....	40, 41	Marine grade .....	264	Bayonet style dry disconnect .....	9
Vacuum relief .....	47	Miniature .....	263	Boss™ .....	67-77
Vapor .....	47	Quick release .....	275	BR-series .....	325
Vent .....	48	Racks .....	275	Cam and groove .....	6-8, 33, 34, 36, 108, 109, 126, 128, 129, 132-137, 139, 140, 141, 151, 152, 175-177, 180, 182
Carded FRL's .....	406	Claw type fittings .....	283-287	CJ-series .....	320
Check valves		Combination nipples .....	115-117, 190-192	DF-series .....	311-315
800 PSI stainless steel .....	559	Bauer style .....	258	Dix-Lock™ quick acting .....	293-296
Ball cone .....	558	Global .....	192	Dry quick disconnects .....	6-18
In-line .....	356, 357	Jump size .....	192	D-series .....	312, 313, 315
Spring loaded .....	559, 560	Sleeves .....	196	Dual Lock quick-acting .....	297-299
Swing .....	560	Combination units		Equipment .....	85, 99
Uni-directional .....	357	Series 1 .....	408, 421	F-series .....	312-315
Chicago type fittings .....	283-288, 362, 365	Watts .....	432	Global Air King™ quick-acting .....	284, 286
Clamp fittings		Wilkerson .....	380, 395-399		
Accessories for clamps		Composite mini ball valves .....	355		
bolt, hex head .....	566	Compound gauges .....	440		
bronze and brass hex nuts .....	566	Compression fittings .....	711-716		



<i>Equipment (cont.)</i>	Page #	<i>Filters/Regulators (cont.)</i>	Page #	<i>Fire fittings, hose &amp; acc. (cont.)</i>	Page #
Coupling inserter .....	904	Watts .....	429, 430	FSA .....	793
Crimpers .....	220-222	Wilkerson .....	378, 379, 391, 392	Hydrant .....	797
Cutters .....	892	Filters		MSA .....	795
for push-on fittings .....	230	Accessories .....	401-405, 422, 423, 434	Rigid female .....	793
Hand hydrotest pump .....	905	Airline .....	381, 382, 408-410	SFSA .....	794
Hydrostatic test pump .....	905	Carded .....	406	SSA .....	797
Test pumps .....	905	Disposable in-line nipple .....	369	SSA30 .....	797
Exhaust muffler		Hydraulic		Suction	
Wilkerson .....	399	In-line .....	528	Female, rocker lug .....	766
External crimp ferrules .....	113, 114	In-line, air/oil .....	368	Male, rocker lug .....	780
External drain cocks .....	554	Lubricator .....	369	Swivels	
Externally swaged fittings .....	87-92	Mini in-line .....	369, 370	Female to male, long handle ..	781
External swage ferrules .....	91, 92	Oil removal .....	410	Female to male, pin lug .....	779
EZ Boss-Lock™ .....	108, 128-130, 133, 136-138, 141, 148, 151, 160, 166	Series 1 .....	406-411, 415, 416	Female to male, rocker lug ...	779, 781
EZLink™ armless		Watts .....	428-430	Male, pin lug .....	779
Bottle opener .....	127, 910	B11 .....	429, 430	Axe .....	820
Couplers .....	126	F602 .....	428	Back flow preventer .....	839
Dust caps .....	127	Wilkerson ...	377-379, 381-385, 391, 392	British instantaneous fittings ...	818, 819
Replacement gaskets .....	127	Finger type clamps .....	75, 76	Cam and groove x NST .....	786
Replacement kits .....	127	Fire fittings, hose & accessories		Type A .....	786
Safety clip .....	127	Adapters .....	186	Type B .....	786
<b>F</b>		Double male		Type D .....	786
Faucets .....	561	Pin lug .....	784	Type F .....	786
Compression bibb .....	561	Rocker lug .....	784	Caps	
Ferrule crimping tools .....	219-222	Rocker lug, style N36 .....	785	Breakable .....	790
Ferrules		Hazmat		Aluminum .....	790
Air King™ .....	287	Pin lug .....	773	Polycarbonate .....	790
API certified .....	98	Hex		Hydrant .....	789
Brass .....	218, 233	Double female .....	766	Pin lug .....	787
Dies .....	219, 221, 222	Double male .....	784	Rocker lug .....	787, 788
Crimped, sanitary .....	106	Double male, NYFD threads ..	783	Test .....	787, 788
Externally swaged ...	143, 144, 194, 195	Hydrant		With cable .....	788
External swage .....	91, 92	Cam & groove .....	785	Specialty .....	790
Global Air King™ .....	288	Pin lug .....	771, 773	Cap test gauges .....	791
Instrumentation .....	710	Rocker lug .....	774	Domestic, pin lug .....	790
Internally expanded .....	94	Long handle		Hydrant .....	790
King Crimp™ .....	113, 114	Style N37 .....	770	Plugs with cable, rocker lug ...	791
Heavy duty .....	118	Style N54L .....	781	Storz .....	798
Short frac .....	79, 117	Style N56 .....	772	Test .....	787, 788
Notched .....	143, 144, 194, 195	Open snoot .....	767	Universal hose .....	789
Oxy-acetylene .....	914	Pin lug		With cable .....	788
Petroleum .....	98	Cam and groove .....	785	Long handle .....	788
Sanitary (IX) style .....	103	NY threads .....	773	With chain .....	789
Scovill style .....	96	Swivel .....	767	Pressurizable cap .....	789
Fill pipe		Rocker lug ...	766-770, 772, 777, 778, 780, 781, 785	Connections	
Adapter caps .....	48	Storz .....	794	International shore .....	819
Adapters .....	46	Style N35 .....	770	Residential sprinkler .....	816
Filter/regulators		Style N36 .....	785	Roof .....	805-807
Accessories .....	422-427, 433, 434	Style N37 .....	777, 778	Siamese	
Carded .....	406	Style N53 .....	769	Double clapper .....	809
Mini's .....	378, 379	Style N54 .....	781	Single clapper .....	808
Series 1 .....	415, 416	Swivel .....	767	Tripler clapper .....	810
		Single male outlet .....	775	Single hydrant .....	816
		Storz		Single inlet .....	816
				Sleeve for sidewalk .....	807
				Couplings	

	Page #		Page #		Page #
<i>Fire fittings, hose &amp; acc. (cont.)</i>		<i>Fire fittings, hose &amp; acc. (cont.)</i>		<i>Fire fittings, hose &amp; acc. (cont.)</i>	
Booster, hose type .....	743	Fire Pro™ .....	757	Street cleaning .....	755
Expansion ring .....	740, 741, 743	Nozzle .....	757	Water fog .....	756
Forestry, forged .....	743	Omega™ .....	757	Play pipes .....	755
Gaskets		Nipples		Tips .....	755
Forestry .....	743	Hex, double male .....	782	Plugs	
Elbows		Hex, female to male .....	774-776	Adjust-A-Plug .....	791
Angle and suction .....	803	Hex, female to male, NY threads .....	776	FDC .....	791
Continuous swivel .....	803			Pin lug .....	792
Storz		Nozzles		Domestic .....	792
30° elbow .....	797	Adjust-A-Power .....	765	Rocker lug .....	792
Long handle, SFSA30 .....	796	Break apart attack .....	761	Pressure restricting device .....	837
Rocker lug, SFSA30 .....	796	Constant flow .....	765	Pump test headers .....	804
Expansion ring & gasket guide .....	742	Displays .....	765	Racks	
Fire jacket		Fog .....	753	Hose .....	748
For hose .....	751	Constant flow .....	759, 760	Hump .....	748
Tape .....	751	Econo .....	760	Covers .....	748
Non adhesive .....	751	Electrical fire .....	752, 758	Pin	
Flange		Flow rate chart .....	753	Covers .....	749
Storz		FM approved .....	758	Hose assembly .....	749
NCS-CSF .....	796	Forestry .....	763	Nipples .....	749
Forestry		Forestry, global .....	762	Semi-automatic .....	749
Expansion ring couplings .....	743	Gaskets .....	758, 759	Wall bracket .....	749
Hose clamp and spanner .....	801	Industrial .....	752	Reels .....	745
Nozzles .....	762, 763	Industrial, heavy duty .....	752	Continuous flow .....	747
Valves .....	830	Industrial, high pressure .....	752	Accessories .....	747
Wrench .....	801	Refinery, blue .....	759	Covers .....	747
Hose		TriFlow .....	760	Global continuous flow .....	746
300# single jacket .....	732	U.S. Coast Guard approved .....	756	Cover .....	746
500# rack		Forestry		Replacement inlet swivel joint .....	746
Non UL labeled .....	736	Twin tip, straight stream .....	764	Style V swing type .....	744
UL labeled .....	735	Gallonge		Covers .....	744
500# single jacket .....	733, 734	Adjustable Tri-Flo .....	762	Swing type .....	745
Color impregnated .....	734	Dual .....	762	Covers .....	745
UL labeled .....	733	Single .....	762	Heavy duty, high capacity .....	745
800# double jacket .....	734	Garden hose .....	760	Pipe brackets .....	745
Color impregnated .....	734	Master stream .....	757	Siamese assemblies	
Cabinet .....	750	Monitor .....	757	Double clapper concealed type .....	815
Double jacket, potable water .....	735	Penetrator .....	764	Two way sidewalk .....	815
Forestry		Pistol grip adapters .....	761	Siamese body .....	811
Forestry mop up .....	737	Plain hose .....	754, 755	Snoots	
Forestry mop up, hose kit .....	737	Rack .....	753	Clapper type, pin lug .....	814
Non weeping .....	737	Global .....	753	Spring check type, pin lug .....	813
Nitrile covered		Shut-off		Sprinkler line tester .....	820
500# .....	736	Ball .....	754, 761	Storz .....	798, 799, 802
Heavy duty .....	738	Ball, forestry grade .....	763	Accessories .....	798
Non-collapsible		Ball, pistol grips .....	763, 764	Adapters .....	794, 797
Chemical booster .....	739	Ball, tips .....	763	Caps .....	798
Fire and utility .....	739	Ball, with nozzle .....	764	Elbows .....	796, 797
Single jacket mine, MSHA approved .....	735	Dual gallonge .....	762	Flanges .....	796
		Single gallonge .....	762	Gaskets .....	798
Hydrant		Street cleaning .....	755	Hydrant wrench .....	799
Adapters .....	186	Tips .....	754	Locking device .....	798
Hydrant body .....	812	Twist .....	754	Mounting plates (bracket) .....	798
Identification plates		U.S. Coast Guard Approved AFFF .....	756	Rigid female .....	793
Round .....	817	Washdown		Rigid male .....	795
Manifolds .....	804			Valves .....	841, 842
Monitor				Wrenches .....	802

<i>Fire fittings, hose &amp; acc. (cont.)</i>	Page #	<i>Fire fittings, hose &amp; acc. (cont.)</i>	Page #	<i>Flareless bite fittings (cont.)</i>	Page #
Suction		Folding pocket	799	Unions	721
Elbows	803	Forestry	801	Flat face fittings	506, 507
Short shank, long handle	803	Grip-All	800	Flomax connectors	
Swivels	831	Hole type	799	¾" series	26
Adapter		Long handle suction	801	Diesel fueling system	19, 20
Female to male, pin lug	779	Storz, pin lug	802	Fuel vent	19-21
Double female	768	Universal	799	Gravity fill receiver	21
Pin lug	768	Storz	799, 802	High flow 1" series	26
Rocker lug	768	Universal	799	R series	24, 25, 27
Elbows	803	Fire hose		Service box	21
Replacement and accessories	792	Axe	911	Standard	22, 23, 27
Storz		Gaskets	856	FloTech™	
Style N35, rocker lug	770	Nozzles	854-857	Rack monitor testers	32
Style N53, rocker lug	769	Spanner wrenches	200	Flow Control	
Style N57, long handle	770	Flame retardant hose protection	898	Series F valves	550
Valves		Flanged		Series MV metering valves	550
Angle	834, 838	Adapters	82, 83, 697	Series N valves	551
500#	822	45° elbow	82	Series PF valves	551
Cast	821, 823	Short	82	Flow control valves	
Forged	824	Straight	82	Legris	355, 356
Ball	832	Cam and groove	160, 181	Foot valves	208
Butterfly	842	ANSI	182	Frac fittings	
Chicago pattern	839	Combination nipple	116, 116	Caps	81
Drain	840	Dry aviation	16	Complete assembly	78
Drip, ball	833	Dry disconnect	7	Female	78
Gate		Dry quick disconnect	11, 12	Ferrules	79
Hydrant	828	External swage fixed	89	Flange adapters	
Hydrant, global	828	Quick-connect, fittings	253-261	45° elbow	82
Hydrant, single	827, 828	Safety break-away	17, 18	Short	82
Large diameter	829	Swivels	49-55	Straight	82
Wedge disc	825, 826	Tank truck	35-38	Male	79
Globe	833, 835	Tee	35	O-rings	79
Pressure reducing	836, 837	Weld adapters	83	Plugs	81
Relief	841	Flanges	697	Union nuts	
Sprinkler hose	840	ANSI flat face	689	One-piece	80
Wye	830-832	Floating	116, 193	FRL's	
Wall hydrants		Gaskets	37, 689	Series 1	406
Exposed 2-way	816	Hydraulic		FRL's (Filters, Regulators, Lubricators)	
Wall plates		Pipe socket weld	525	Accessories	401-405, 422-427, 433, 434
For concealed 3-way bodies	814	Lap joint	688	Carded	406, 407
For double clapper	814	NPT	688	Combination units	380, 395-398, 408, 421, 432
Washers		Slip-on	35, 688	Displays	405, 406
Swivel	741	Weld neck	689	Filter/Regulator	378, 379, 429
Tail	741	Flare fittings	717-719	Filters	366, 368-370, 383, 385, 406-411, 428, 429
Wharf hydrants	830	37°	510-516, 522, 523	Lubricators	368, 369, 406, 408, 417-420, 431
Wrenches		Connectors	717	Regulators	370, 406, 407, 412-416, 429, 430
Adjustable		Elbows	718, 719	Series 1	370, 406-427
Double head	800	Nuts	719	Watts	428-434
Hydrant	799, 800	Tees	719	Lubricators	431
Pigtail	800	Unions	718	Wilkerson	377-405
Hydrant	801	Flareless bite fittings	720	Fuel nozzles	19, 20
5 hole	800	Adapters	720, 721	Fuel receivers	19, 20
Adjustable	799, 800	Elbows	721, 722		
Double head adjustable	800	Ferrules	722		
Pigtail adjustable	800	JIC	720		
Storz	799	Nuts	722		
Spanner	799, 801, 802	Tees	722		

	Page #		Page #		Page #
<b>G</b>		<b>Gauges (cont.)</b>		<b>H</b>	
Garden hose		Liquid filled		Hammer unions	681-683
Adapters	239-241	ABS case	441	Caps	81
Back flow preventer	245	Brass	443	One-piece nut	80
Compression bibb faucets	243	Stainless steel	441, 442	Plugs	81
Country Club® RT	885	Panel builder	439	Two-piece nut	80
Coupler	243, 244	PITOT	907	Handles, cam and groove	130, 165, 166, 175, 179, 182
Flexogen®	883	Process	437	Hex bushings	658
Flexzilla®	884	Sprinkler system	907	Hex manifolds	367
Gooseneck	245	Steam siphons	444	Hex nipples	197
Hex nut with knurl	242	Three way	907	Holedall™	
Hot water rubber reinforced	884	Tire inflator chuck	376	Couplings	90, 92, 95, 97
Lok-on hose fittings	226	Tire pressure		DIN external crimp stem	106
Caps	230	Dual foot	376	Dubl-Grip® re-attachable	100
Manifold	245	Heavy duty	376	Expander machine	99
Marine, camper, patio & pool	885	Passenger car	376	Female end	90
Menders	236, 239, 252	Professional	376	Ferrules	91, 92, 94, 96, 98, 103, 106
Perfect water	884	Vacuum	440	Flanged assemblies	89
Plugs	243	Welding	443	Nipples	88, 89
Premium rubber	883	Wilkerson regulator	402	Permanent pump	99
Quick connectors	243	Gravity drop adapters	29	Sanitary crimp style	104, 105
Radiator bibb	245	Dust caps	30	Sanitary (IX) style	101, 103
Round nut with knurl	242	Grease whip	912, 913	Stems	
Rubber vinyl	883	Hose assemblies	912	External swage	88-90
Shank fittings	234-237	Hose fittings	912	Internal expansion	93, 94
Spray hose fittings	238	Zerk	913	Swaging machines	85
Top level PVC	884	Retail packaged	913	Washers	99
Tuff-Lite™	250, 251	Grip-L couplings	686	Hookie - hook hose lifter	683
Valves	244, 245	Grooved fittings	695, 698	Horizontal swing check valves	560
Washers	242	Accessories	701	Hose	
Zinc fittings	239	Clamps	695	Air	890, 891
<b>Gas</b>		Gaskets	695	Air, self-storing	890, 891
Dry couplings	14	End caps	699	Coil-chief	890
Regulators	414	Gaskets	700	Assembly kits	890
<b>Gaskets</b>	677, 697	Lightweight	692	Bulk hose	890
Agri-Lock style	256	Mechanical tees	696	Braided rubber	880
Bauer style	261	Quick release	690	Bumper stops	882
Cam and groove	127, 167-171	Rigid	694	Contractors	883
Foot valve	208	Series 45	698	Crimper	221, 222
Holedall™	99	Series 90	698	Cutters	892
Railroad tank car	59	Series AN	699	Diameter tape	909
Sand blast	290	Series BE	699	Fittings, barbed	211-214, 216, 217, 223-229, 247, 248, 251, 294, 295, 298, 301-304, 306-309, 312, 314-319, 322-327, 329
Shank couplings	205	Series EC	699	Flexogen®	883
Tank truck		Series FA	697	Flexzilla®	884
Transport	40	Series RA	697	Garden	883-885
TTMA	37	Series SF	697	Hot water reinforced	884
<b>Gauges</b>	907	Series T	696, 698	Hot water washdown	880
Compound	440	Standard	691	Knife	909
Contractor pressure	439	Grooved nipples	699	Mallet	909
Digital	444	Grooved stem style ext. crimp ferrule		Menders	74, 209, 210, 236, 249, 252
Dry		113-114		Mill	874-877
ABS standard	435	Grooved valves	699	Synthetic double jacket	877
Brass standard	437	Groove lube	701		
Flutter Guard™	438	Ground joint			
Stainless steel	436	Fittings	77, 110		
Line test	907				









	Page #		Page #		Page #
<i>Quick Disconnects (cont.)</i>		<i>Reducers (cont.)</i>		<i>Sanitary (cont.)</i>	
AG-series .....	461, 462	Combination nipples .....	192	Pipe fittings .....	601
CM-series .....	502-505	Hex bushings .....	658, 659	Polished .....	608
CVV-series .....	496, 497	Instrumentation .....	708	Unpolished .....	611
EA-series .....	501	Tuff-Lite™ .....	247	<b>Bevel seat fittings</b> .....	589-593
E-series .....	498-500	<b>Reels</b>		<b>BioPharm fittings</b> .....	625-630
H-BOP-series .....	457	Hand crank .....	882	<b>Breakaway coupling</b>	
H-series .....	450-456	Reelcraft® hose .....	881, 882	Bevel seat .....	592
HS-series .....	458	Reelcraft® static discharge .....	45	<b>Breakaway coupling - clamp</b> .....	577
HTE-series .....	477	<b>Regulators</b>		<b>Butterfly valves</b>	
HT-series .....	473	Accessories .....	402-405, 424, 434	Replacement seats .....	636
HTZ-series .....	478	Carded .....	406	<b>Caps</b> .....	569
K-series .....	459, 460	Dial air .....	386	BioPharm .....	630
PD-series .....	482	Gas .....	414	<b>Clamp fittings</b> .....	569
ST-series .....	479-481	<b>High flow</b> .....	389, 390	End .....	591, 600, 617
TR-series .....	472, 474-476	<b>High pressure</b> .....	387, 388	<b>European fittings</b> .....	585
T-series .....	494, 495	Manifold .....	414	I-line .....	596
VEP-BOP-series .....	486	Mini general purpose .....	370	Q-line .....	596
VEP-series .....	483-485	Mini water .....	378, 414	Thermometer .....	569
V-series .....	463-471	Series 1 .....	406, 407, 412-416	Unpolished .....	611
WS-BOP-series .....	493	Water .....	415	<b>Clamp accessories</b> .....	566
W-series .....	487-489	Watts .....	429, 430	<b>Clamp fittings</b> .....	567-576
WS-series .....	490-492	Wilkerson .....	377-379, 386-391	<b>Clamps</b> .....	564-566, 594
<b>Pneumatic</b>		<b>Replacement handles</b>		Accessories .....	566
<b>Air Chief</b>		Cam and groove .....	182	Nuts .....	566
ARO .....	308, 309			Bolted .....	565
Automotive .....	306, 307	<b>S</b>		Dairy .....	566
Industrial .....	300-303	<b>SAE fittings</b> .....	229, 263, 266, 275, 506, 508-510, 527, 544, 894	Double pin .....	564
Lincoln .....	310	<b>Safety</b>		<b>Pipe fittings</b> .....	599
A-series .....	326, 327	Blow gun .....	371, 372	Single pin heavy duty .....	564
BR-series .....	325	Break-away couplings .....	17, 18	Single pin squeeze .....	564
CJ-series .....	320	Cables .....	362, 364	T-bolt .....	565
DF-series .....	311-315	Shackles .....	364	Three segment .....	565
J-series .....	316, 317	Check valves .....	556	Toggle .....	565
Legris .....	305	Clips and lanyards .....	172, 182, 289	<b>Crimp style</b> .....	105
L-series .....	322	Information .....	916-919	<b>Crosses</b>	
M-series .....	318, 319	Legris industrial coupler .....	305	Clamp .....	575
NK-series .....	324	Locking pin .....	292	<b>Polished fittings</b> .....	609
N-series .....	293-296	Pop-off valves .....	557	<b>Elbows</b> .....	572, 573, 610
Parker E-z-mate .....	304	Tape and tag .....	910	45° clamp .....	573
P-series .....	297-299	Vented ball valves .....	534	90° clamp .....	572, 573
SHD-series .....	321, 322	Vent-Lock™ .....	128-130	BioPharm .....	625, 626
U-series .....	323	Whipsocks .....	364	Plain bevel seat	
<b>Quick release couplings</b> .....	690	Shackles .....	364	.....	592
		<b>Sand blast couplings</b> .....	290	Polished .....	604-606
<b>R</b>		<b>Sanitary</b>		Threaded bevel seat	
Rack cords .....	31	<b>Adapters</b>		.....	592
Rack monitor .....	32	Bevel seat .....	591	Unpolished .....	610, 611
<b>Racks</b>		Brewery hose .....	570	<b>European fittings</b> .....	585-588
Worm gear clamp .....	275	Brewery hose barb .....	570	<b>DIN fittings</b> .....	585
Radiator bibb .....	245	Clamp .....	569, 571, 572	Caps .....	585
Railcar unloading assemblies .....	36, 38, 56-59	<b>Clamp fittings</b> .....	569, 571, 572	Gaskets .....	588
Railroad tank car		Female NPT .....	572	Nuts .....	585
Fittings .....	56, 57	Hose .....	569, 570	Welding .....	585
Gaskets .....	59			<b>RJT BS: 4825 fittings</b> .....	587
<b>Reducers</b>					
Cam and groove .....	152-156				

<i>Sanitary (cont.)</i>	Page #	<i>Sanitary (cont.)</i>	Page #	<i>Sanitary (cont.)</i>	Page #
Caps .....	587	.....	592	Pneumatically actuated, 3-piece ..	646
Gaskets .....	588	Unpolished .....	613	.....	646
Nuts .....	587	Sight glass .....	617, 618	<b>Butterfly</b> .....	633-636
Welding .....	587	Compact .....	618	Clamp end .....	633-636
Wrenches .....	586, 587	Replacement glass .....	618	Repair kits .....	634, 635
<b>SMS fittings</b> .....	586	In-line .....	617	Wafer, pneumatically actuated	650
Caps .....	586	Replacement glass .....	617	Spring check .....	637
Gaskets .....	588	Seal kit .....	617	Tank vent .....	640, 641
Nuts .....	586	Sight glass end caps .....	617	<b>Weld fittings</b> .....	584, 595, 596, 599-601, 604-614, 625-630
Welding .....	586	<b>Spray balls</b>		Boss-Lock™ coupler .....	584
Ferrules .....	567, 568, 590, 596	Rotating .....	616	Cam and groove adapter .....	584
BioPharm .....	630	Stationary .....	616	<b>Wrenches</b> .....	589
I-line .....	595	<b>Strainers</b> .....	621, 622	Single sided	589
<b>Pipe fittings</b> .....	599, 600	Filters .....	622	.....	589
Q-line .....	596	In-line .....	621	Spanner .....	587
Quick weld .....	577	Mesh over screens .....	622	Two sided	589
Recessless		Side-entry .....	621	.....	589
.....	590, 591	Side-outlet reverse .....	621	<b>Sanitary crimp fittings</b>	
Reducing		Stub ends, type A .....	613	Ferrule, 304 stainless .....	106
.....	568	<b>Swivels</b>		<b>Sanitary (IX) fittings</b>	
Roll-on		Straight swivel clamp .....	619	Ferrule, flow chief .....	103
.....	568	Straight weld connection .....	619	Hex nuts .....	102
Weld		<b>Tees</b>		Plugs .....	101
.....	567, 568, 590, 591	BioPharm .....	626, 627	Stems	
Flanges .....	615, 624	Clamp .....	574	Bevel seat .....	102
Gaskets		Clamp reducing .....	574	Clamp end .....	101
Bevel seat .....	593	Short outlet clamp .....	574	Male NPT .....	102
Clamp .....	578-583	Unpolished .....	612	Tube weld end .....	101
I-line .....	597, 598	Weld .....	607	<b>Screw pitch gauge</b> .....	909
<b>Pipe fitting</b> .....	603	<b>Transition fittings</b> .....	584	Sealant .....	903
Q-line .....	598	Cam and groove adapter .....	584	Joint .....	903
Gauges, pressure .....	620	Cam and groove coupler .....	584	Thread .....	903
I-line fittings .....	595-598	<b>Tube hangers</b> .....	623, 624	Security chains .....	171
<b>Miscellaneous configurations</b>		Nuts .....	624	Self-storing air hose .....	890, 891
Laterals .....	609, 614	Sleeves .....	623	Series 1 FRL's .....	370, 406-427
.....	576	<b>Unpolished fittings</b> .....	610-615	Set screw buckles .....	270
Return bends .....	576, 609, 614	<b>Valves</b>		Shackles .....	364
Wyes .....	576, 609, 614	3A sample .....	642	<b>Sharkbite® push to connect fittings</b>	723, 724
<b>Nuts</b>		Accessories, actuated .....	652	Connectors .....	723
.....	589	Limit switches .....	652	Couplings .....	723, 724
<b>Pipe fittings</b> .....	599-603	Positioners .....	652	Disconnect clips .....	724
<b>Pipe hangers</b> .....	602	Solenoids .....	652	Elbows .....	724
Sleeves .....	602	<b>Air blow check valves, repair kits</b> .....	639	End stops .....	724
Sleeves, pipe hanger .....	602	<b>Ball</b>		Tees .....	724
<b>Polished fittings</b> .....	604-609	Check .....	638	Short shanks ...	198, 199, 201, 210, 247, 250
<b>Protection covers</b>		Electrically actuated .....	643-645	<b>Shut-off</b>	
Clamp end .....	576	Electrically actuated, 2-piece ..	643	Valves .....	403, 559
Weld end .....	610	Electrically actuated, 3-piece ..	643	<b>Sight flow indicators</b> .....	37, 38, 60
<b>Q-line fittings</b> .....	594, 596, 598	Electrically actuated, 3-way ...	645	Flanged acrylic sight flow indicators ..	38
<b>Reducers</b>		Encapsulated .....	631	Repair kits .....	38
BioPharm .....	628, 629	Flow options / patterns .....	651	TTMA pattern .....	38
Concentric .....	575	Multi-port .....	651	<b>Sight glasses</b>	
Eccentric .....	575	Non-encapsulated .....	632	Replacement glass .....	618
Plain bevel seat		Pneumatically actuated ...	646-649	Single bolt clamps .....	280
.....	592	Pneumatically actuated, 2-piece ..	646	<b>Skimmers</b> .....	207
<b>Polished fittings, weld</b> .....	608				
<b>Threaded bevel seat</b>					

	Page #		Page #		Page #
Sleeves	111, 112, 117, 196, 339, 341, 715	<b>Stems (cont.)</b>		Tank transport equipment	
Spanner wrenches	200	Washer seal	71	Pipe caps	40
Speed control mufflers	448	Strainers	206-208	Reducers	40
Spill kits	908	Disk	171	Reducing cap	40
Spiral		Polypropylene	206	Tank truck	
Hose and cable protection	898	Round hole	206, 207	API	
Hose clamps	281	Square hole	206	Coupler	28
Spool adapters & couplers		T line	703	Valve	28
Cam and groove	180	Witches hat	171	Breakaways	849
Spray hose		with spring loaded check valves	560	Coupler x round flange	36
Couplings	204, 238	Y Line	703	Diesel nozzles	850
Spring Guard	900	Straps		Drop elbows	42-44
Spring return handle ball valves	533, 541	King Cable™	363	Elbows	42-44
Sprinkler		Straub pipe couplings	686, 687	Flanged tee	35
Line tester	907	Stretch strap	911	Gaskets	37
System gauge	907	Suction hose couplings	198, 199	Nozzle accessories, fuel	849
Spuds		Boss™ LPS	79	Nozzles	845-847, 850-853
Boss™		Super King™ shank couplings	200	Swivels	50, 53
Double	69, 72, 77	Surelock™ quick acting couplings	291, 292	Split flange	55
Female	67, 68, 71, 77	Swaged fittings	69, 87-92	Split flange components	55
Hose shank	74	Swage nipples	679	Bearing pack	55
Male	69, 72, 77	Swaging machines	85	Nose piece	55
Squeeze Lok™ hose assembly tool	230	Swivel connectors		Seal kits	55
Stainless steel		Ball	857	Vapor recovery	33, 34
Boss™		Straight	857	Tank truck equipment	
Clamps	75, 76	Swivels	506, 507, 509, 894	Intermodal tank transport	41
Ground joint	67, 77, 110	37°	512, 513	Tank transport	40
Male stem	73, 74	Air King™	287	TTMA flange extensions	36
Dry disconnect	11	Air tool	447	Tape	902, 910
Dry quick disconnect	6, 7, 12	Angled	329	Diameter	909
Ferrules	92	Angled industrial plugs	301	PTFE tape	902
Gate valves	547	Ball, with Air Chief plugs	301	Safety	910
Gauges	436, 439, 441, 442	Ball, with hose barb	447	T-Bolt clamps	276-278
GHT adapters	239-241	Bent stem	329	Tees	510
Inserts	340	Connectors for spray gun	857	Air brake	339
Menders	209	Diesel fuel	21	Bull head	669
Notched shank cam and groove	135, 136, 143, 144	Dubl-grip reattachables	100	Compression	714, 715
Push-in	346, 347	Hose	848, 849	Female reducing	669
Strainers	206	Hose barb	211, 213, 216, 217, 223, 225-229, 232	Female threaded	668
Swaged fittings	138, 143	In-line	447	Flare	719
Thermometers	445	JIC	896	Hydraulic	507, 514
Steam		Joints	49, 50	Flat face	507
Gauge siphon	444	Loading arm	53	NPTF	521
Hose couplings	13	Multi-plane hose	849	ORB fittings	508-510
Valve, 250 Lb.	534	Push-in fittings	330, 331, 344, 345	Instrumentation	709
Stems		Push-on fittings	447	LIQUIfit™	726-728
Bent swivel	329	Single plane hose	849	Mechanical	696
External swage	88-90, 195	<b>T</b>		Push-in	331, 334, 335, 344, 347, 349, 353, 354, 359, 360
Ground joint	67	Tag, hose assembly	910	Sched. 80 polypropylene	675
Ground joint air hammer	77	Tank car		Sharkbite®	724
Holedall™ DIN external crimp	106	Fittings, railroad	36, 38, 56-59	Side outlet	669
Internal expansion	93, 94	Gaskets	59	Splicers	215
King™ combination	190-192, 195, 196	Wrenches	59	Street service	669
LP Boss™	74			Threaded side outlet	669
Reusable brass	232, 233			Tuff-Lite™	249
Sanitary style	101, 102, 105			Test plugs and caps	906



**W**

Wafer ball valves .....	542
Washdown	
Nozzles	
Hot water .....	858
Industrial .....	857
Mini spray .....	859
Spray .....	859
Spray valves .....	861
Hose assembly .....	861
Station .....	864
Hot and cold water mixing .....	864
Rack for mixing .....	864
Water-steam .....	864
Swivel connectors .....	857
Washers	
Air King™ .....	289
Boss™ .....	72
Cam and groove .....	168-170
Garden hose .....	242
Holedall™ petroleum .....	99
Suction and shank fittings .....	205
Water regulators .....	378, 414
Watts FRL's .....	366, 428-434
WaveSeal clamps .....	265
WD-40 .....	908
Welding	
Cam and groove .....	161, 162
Gauges .....	443
Nipples .....	684
Whipsocks .....	364
Shackles .....	364
Wilkerson FRL's .....	377-405
Witches hat strainers .....	171
Worm gear clamp rack .....	275
Worm gear clamps .....	263-266, 275
Marine grade .....	264
Wrenches	
Pin lug .....	59, 200
Spanner .....	200, 705
Wrench grips .....	685

**Y**

Y, compressor .....	367
Y, connectors .....	335, 360
Y, dual valve .....	537
Y, garden hose coupler .....	244
Y, garden hose valve .....	244
Y, GHT .....	244
Y line strainers .....	703
Y, unions .....	335

**Z**

Zerk fittings .....	913
---------------------	-----

Part Number Index

In the following index, a (\*) is used to represent a variable. Therefore, to find AD075EZ or AD400EZ, look for: AD\*\*\*EZ

Page #	Page #	Page #	Page #
	•HBF•-S ..... 450	•STBF• ..... 479	•WSBF• ..... 490
	•HBF•-SS ..... 450	•STBF•• ..... 479	•WSBF•-SS ..... 490
	•H-BRKIT ..... 456	•STBF••-SS ..... 479	•WSDP-A ..... 492
	•HDP-A ..... 454	•STBF•-SS ..... 479	•WSF• ..... 490
	•HDP-H•DC ..... 454	•ST-BMK ..... 481	•WSF•-BOP ..... 493
	•HF• ..... 450	•STDP-A ..... 481	•WSF•-SS ..... 490
	•HF•-B ..... 450	•STF• ..... 479	•WSF•-SS-BOP ..... 493
	•HF•-BOP ..... 457	•STF•• ..... 479	•WSFH• ..... 491
	•HF•-S ..... 450	•STF••-SS ..... 479	•WSFP• ..... 491
	•HF•-SS ..... 450	•STF•-SS ..... 479	•WSOF• ..... 490
	•HF•-SS-BOP ..... 457	•STOF• ..... 479	•WS-RKIT ..... 492
	•HOF• ..... 450	•STOF•• ..... 479	•WS-SKIT ..... 492
	•H-RKIT ..... 456	•ST-SKIT ..... 481	
	•HSBF•-B ..... 458	•TDP ..... 495	••CVVBF•• ..... 496
	•HSBF•-S ..... 458	•TM• ..... 494	••CVVDP ..... 497
	•HSF•-B ..... 458	•TRBF• ..... 472	••CVVF•• ..... 496
	•HSF•-S ..... 458	•TRF• ..... 472	••EF••-B ..... 498
	•H-SKIT ..... 455	•TR-SKIT ..... 472	••EF••-S ..... 498
	•H-SRKIT ..... 456	•VBF•-B-E ..... 466	••EM••-B ..... 498
	•H-SSRKIT ..... 456	•VBF•-E ..... 466	••E-SKIT ..... 500
	•HTBF• ..... 473	•VBF•-SS-E ..... 466	••HBF•• ..... 452
	•HTBF•• ..... 473	•V-BRKIT ..... 471	••HBF••-B ..... 452
	•HTBF••-SS ..... 473	•VDP-A ..... 469	••HBF••-S ..... 452
	•HTBF•-SS ..... 473	•VDP-V•DC ..... 469	••HBF••-SS ..... 452
	•HTDP ..... 475	•VEPBF• ..... 483	••H-BRKIT ..... 456
	•HTF• ..... 473	•VEPDP-A ..... 484	••HDP-A ..... 454
	•HTF•• ..... 473	•VEPF• ..... 483	••HF•• ..... 452
	•HTF••-SS ..... 473	•VEPF•-BOP ..... 486	••HF••-B ..... 452
	•HTF•-SS ..... 473	•VEPFH• ..... 485	••HF••-S ..... 452
	•HTJB• ..... 475	•VEFPF• ..... 485	••HF••-SS ..... 452
	•HTM• ..... 473	•VEPOF• ..... 483	••HOF•• ..... 452
	•HTOF• ..... 473	•VF•-B-E ..... 466	••H-RKIT ..... 456
	•HTOF•• ..... 473	•VF•-E ..... 466	••H-SKIT ..... 455
	•HTOM• ..... 473	•VF•-SS-E ..... 466	••H-SRKIT ..... 456
	•HTRB• ..... 475	•VJM• ..... 464	••H-SSRKIT ..... 456
	•KBF• ..... 459	•VM• ..... 464	••HTBF•• ..... 473
	•KBF•-SS ..... 459	•VM•-B ..... 464	••HTF•• ..... 473
	•KDP-K•DC ..... 460, 469	•VM•-B-E ..... 467	••HTOF•• ..... 473
	•KF• ..... 459	•VM•-E ..... 467	••KBF•• ..... 459
	•KF•-SS ..... 459	•VM•-SS ..... 464	••KF• ..... 459
	•KOF• ..... 459	•VM•-SS-E ..... 467	••K-SKIT ..... 460
	•K-SKIT ..... 460	•V-RKIT ..... 471	••STBF•• ..... 479
	•PDF• ..... 482	•V-SKIT ..... 470	••STF•• ..... 479
	•PDM• ..... 482	•V-SSRKIT ..... 471	••STOF•• ..... 479
	•SFBP ..... 55	•WBF•-B ..... 487	••VBF••-B-E ..... 466
	•SFNPCS ..... 55	•WBF•-B-HN ..... 487	••VBF••-E ..... 466
	•SFNPSS ..... 55	•WDP ..... 488	••VBF••-SS-E ..... 466
	•SFSK-BAYLAST ..... 55	•WF•-B ..... 487	••VDP-A ..... 469
	•SFSK-TESS ..... 55	•WF•-B-HN ..... 487	••VEPBF•• ..... 483
	•SFSK-VI ..... 55	•W-RKIT-V2 ..... 489	••VEPDP-A ..... 484
•AGBF• ..... 461			
•AGBF•-PV ..... 461			
•AGDP ..... 462			
•AGF• ..... 461			
•AGF•-PS ..... 461			
•AGF•-PV ..... 461			
•AGF•-PV-PS ..... 461			
•AGOF• ..... 461			
•AGOF•-PS ..... 461			
•AGOF•-PV ..... 461			
•AGOF•-PV-PS ..... 461			
•CM4B•-B ..... 504			
•CM4B•-B-E ..... 504			
•CM4S•-B ..... 504			
•CM4S•-B-E ..... 504			
•CM9B•-B ..... 505			
•CM9B•-B-E ..... 505			
•CM9S•-B ..... 505			
•CM9S•-B-E ..... 505			
•CMB•-B ..... 503			
•CMB•-B-E ..... 503			
•CMF•-B ..... 503			
•CMF•-B-E ..... 503			
•CMPC-B ..... 505			
•CMS•-B ..... 503			
•CMS•-B-E ..... 503			
•CM-SKIT ..... 505			
•CVVBF• ..... 496			
•CVVDP ..... 497			
•CVVF• ..... 496			
•CVVFM•••• ..... 496			
•CVVOF• ..... 496			
•EAF• ..... 501			
•EBF•-B ..... 498			
•EF•-B ..... 498			
•EF•-S ..... 498			
•EM•-B ..... 498			
•EM•-S ..... 498			
•ES•-B ..... 498			
•E-SKIT ..... 500			
•HBF• ..... 450			
•HBF•-B ..... 450			

Part Number	Page #	Part Number	Page #	Part Number	Page #
••VEPF••	483	105••••	217	1255••H	510
••VEPF••-BOP	486	105••••C	217	125-A••	131
••VEPFH••	485	1091P••••	889	125-AA••	154
••VEPFP••	485	1091U••••	889	125-B••	132
••VEPOF••	483	1091U••R00	889	125-C••	134
••VF••-B-E	466	1092T••••	889	125C-90••	158
••VF••-E	466	1094P••••	889	125-D••	139
••VF••-SS-E	466	1094U••••	889	125D-90••	158
••VJM••	464	1094U••R00	889	125-DP••	149
••VM••	464	10-DBHU-10	708	125-E••	142
••VM••-B	464	10-DCAP	710	125-F••	145
••VM••-E	467	10-DELU-10	709	125-G••	168, 169
••VM••-SS	464	10-DFC••	707	125-G••••	168, 170
••VM••-SS-E	467	10-DFPLUG	710	125GTFACC	170
••V-SKIT	470	10-DMC••	707	125GTFVI	169
••WBF••-B	487	10-DTTT-10	709	125GTHK	168
••WBF••-B-HN	487	10-DU	708	126••••	213
••WDP	488	11-009••••	415	126••••C	213
••WF••-B	487	1125A	845, 846	128P•LJ15	89
••WF••-B-HN	487	112D	846	128P•SO15	89
••W-RKIT-V2	489	112DNS	846	129••••C	214
••WSBF••	490	112DSK	846	129••••CLF	214
••WSBF••-SS	490	114/2D-TK	847	129••••SS	214
••WSDP-A	492	1143A	845, 846	12-DBHU-12	708
••WSF••	490	114D	846	12-DCAP	710
••WSF••-BOP	493	114DAL-AV-16	847	12-DELU-12	709
••WSF••-SS	490	114DAL-AV-19	846	12-DFC••	707
••WSF••-SS-BOP	493	114DAL-AV-25	847	12-DFE-12	708
••WSFH••	491	114D-AV	847	12-DFE-8	708
••WSFP••	491	114D-AV-06ASM	847	12-DFPLUG	710
••WSOF••	490	114DAVR	847	12-DMC••	707
••WS-RKIT	492	114DAV-SK	847	12-DMC••••	707
••WS-SKIT	492	114DNS	846	12-DME-12	708
0••••	273, 274, 888	114DSK	846	12-DME-8	708
0••••	888	11963	685	12-DRATT-16	708
0••R	273	1204••••	511	12-DRATT-8	708
001••••	912	1208••	888	12-DTMT••	709
0010••C	912	1217AR••	365	12-DTTM-12	709
0304C••	515	1217AR-4••	365	12-DTTM-8	709
0304C••••	515	1217AR-4AK-KSW	364	12-DTTT••	709
0306••	516	1217AR-4AKWF	366	12-DTTT-12	709
0306••••	516	1217FRAME	365	12-DU	708
0318••	515	1231••••	508	12P•	90
0318••••	515	1234••••	512	12SFO	526
0319••	515	1238••••	509	12SFXO	526
0319••••	515	124••••K	213	13••	566
0610-4	751	1240••••	510	13••••	566
0817••	888	1250-94	847	1310-8	751
0817BL100	888	1250SK	847	134••••	214
09-31•-00001	819	1251••H	522	134••••C	214
		1254••H	515	139••••	216
1•	280				
1••	273				
1••••	273, 274, 279, 888				
1••••	264, 888				
1••R	273				
1••R	273				
10-076-004	418				
100-A••	131				
100-AA••	154				
100-A-HA	150				
100-AL••	160				
100AWBPSTSS	162				
100AWSPSS	162				
100-B••	132				
100BHAN-AL	53				
100-C••	108, 134				
100-D••	139				
100D-90••	158				
100DA-90••	157				
100-DC••	146				
100DHAN-AL	53				
100-DL••	160				
100-DP••	149				
100DWBWPSTSS	161				
100DWSP••	161				
100-E••	109, 142				
100-E-HA	150				
100-F••	145				
100-F-HA	150				
100-G••	168, 169				
100-G••••	168, 170				
100GTFACC	170				
100GTFVI	169				
100GTHK	168				
100-HP-SP	165				
100PRSCSS	171				
100TP	906				
1010-6	751				
1012CIPUSH	904				
1015-DA••	152				
102••••BSPT	212				
102••••C	211				
102••••CLF	211				
10210-64	751				
1025P••••	359				
103••••	211				
103••••C	211				
104••••C	212				
104••••CLF	212				
104••••SS	212				



Part Number Index

Index Part Number

Page #	Page #	Page #	Page #
139...C ..... 216	13WN• ..... 566	14WLI-R... ..... 595	150DWSP• ..... 161
13BNH ..... 566	13WNV ..... 566	14WLMP-G... ..... 567	150-E-• ..... 109, 142
13CB-•• ..... 566	14003-•• ..... 471	14WLMP-R... ..... 567	150-E-ALH ..... 142
13H-G... ..... 589	1404-•• ..... 519	14WMP-G• ..... 567	150-E-HA ..... 150
13H-G...RJT ..... 587	1404-••• ..... 519	14WMP-G... ..... 567	150ENOSSS ..... 144
13HS-• ..... 623	1404-••• ..... 519	14WMP-G...• ..... 567	150-F-•• ..... 145
13HS-•• ..... 623	1404-•••• ..... 519	14WMP-R• ..... 567	150F-•• ..... 718
13IB ..... 566	1405-•• ..... 519	14WMP-R... ..... 567	150F-90AL ..... 159
13IB6 ..... 566	1405-••• ..... 519	14WMP-R...• ..... 567	150-F-ALH ..... 145
13ILB•• ..... 594	1405-•••• ..... 519	14WMV-R... ..... 599	150-F-HA ..... 150
13ILB•••• ..... 594	14-19-G... ..... 591	14WMX-R... ..... 599	150-G-•• ..... 168, 169
13ILH•• ..... 594	142-••• ..... 216	14WQ-G... ..... 596	150-G-••• ..... 168, 170
13ILH•••• ..... 594	1420••C ..... 216	15•0904C ..... 914	150GPCTF ..... 40
13LW ..... 566	143-••• ..... 216	15•0909C ..... 848	150GTF•• ..... 169
13MHHM•• ..... 564	1430••K ..... 216	1500SK ..... 520	150GTFACC ..... 170
13MHHM••• ..... 564	1430407KLF ..... 216	1501-•• ..... 520	150GTHK ..... 168
13MHHM•••• ..... 564	144-••• ..... 217	1501-••• ..... 520	150TP ..... 906
13MHHM••••SN ..... 564	144•••K ..... 217	1501-•••• ..... 520	1510-B-•• ..... 155
13MHHM••••SN ..... 564	144F-• ..... 719	1501-•••• ..... 520	1510-C-•• ..... 155
13MHHM•••SN ..... 564	145-••• ..... 217	1502-•• ..... 520	1510-D-•• ..... 156
13MHHM-3P•• ..... 565	145•••K ..... 217	1502-•••• ..... 520	1510DAAL ..... 152
13MHHM-3P••• ..... 565	149F-•• ..... 718	1503-•• ..... 520	1510-DA-SS ..... 152
13MHHM-3P•••• ..... 565	149F-••• ..... 718	1503-•••• ..... 520	1510-E-•• ..... 156
13MHHM-DP•• ..... 564	149F-•••• ..... 718	15030FXF••00000 ..... 50	1520-AA-•• ..... 154
13MHHM-DP••• ..... 564	14A-G•• ..... 590	150-A-•• ..... 131	1520-DA-•• ..... 152
13MHHM-DP•••• ..... 564	14A-R••DIN ..... 585	150A-90•• ..... 157	1520-F-•• ..... 156
13MHHM-Q• ..... 564	14A-R••RJT ..... 587	150-AA-•• ..... 154	1540••K ..... 914
13MHHM-Q•• ..... 564	14A-R••SMS ..... 586	150-A-ALH ..... 131	156..... ..... 76
13MHHM-Q•••• ..... 564	14MPHR-G•• ..... 570	150-A-HA ..... 150	156-••• ..... 914
13MHHV•• ..... 599	14MPHR-G•••• ..... 570	150-AL-•• ..... 160	1565U ..... 848
13MHLA•• ..... 565	14MPHR-G••••• ..... 570	150AWBPST•• ..... 162	158-••• ..... 914
13MHLA100-150 ..... 565	14MPHRL•• ..... 570	150AWSP•• ..... 162	159F-•• ..... 719
13MHP•• ..... 565	14MPHR-R•• ..... 570	150-B-•• ..... 132	15A-G•• ..... 591
13MHPV•• ..... 599	14MPHR-R••• ..... 570	150B-90•• ..... 158	15A-R••DIN ..... 585
13MO•• ..... 565	14MPHR-R•••• ..... 570	150-B-ALH ..... 132	15A-R••RJT ..... 587
13MO••• ..... 565	14MPHR-R••••• ..... 570	150-C-•• ..... 108, 134	15A-R••SMS ..... 586
13MO100-150 ..... 565	14MPHT-R•• ..... 569	150C-90•• ..... 158	15B15-••RAF ..... 739
13NHN-G• ..... 624	14MPHT-R••• ..... 569	150-C-ALH ..... 134	15B15-••RAS ..... 739
13NHN-G•••• ..... 624	14MPW-R•• ..... 568	150CNOSSS ..... 135	15B15-••RBF ..... 739
13PS-• ..... 623	14MPW-R••• ..... 568	150-D-•• ..... 139	15B15-100RAF ..... 739
13PS-•• ..... 623	14PRF-G•• ..... 590	150D-90•• ..... 158	15B15-100RAS ..... 739
13PV-•• ..... 602	14QMP-G•• ..... 577	150DA-90•• ..... 157	15B15-100RBF ..... 739
13RBN-G••RJT ..... 587	14R-G•• ..... 590	150-D-ALH ..... 139	15R-G•• ..... 591
13R-G••DIN ..... 585	14RMP-G•• ..... 568	150-DC-•• ..... 146	15WI-G•• ..... 595
13R-G••SMS ..... 586	14RMP-R•• ..... 568	150-DC-ALH ..... 146	15WI-R•• ..... 595
13RP ..... 566	14VB-R•• ..... 613	150DC-L•• ..... 147	15WLI-G•• ..... 595
13RP6 ..... 566	14WHRL-R•• ..... 608	150-DD-•• ..... 154	15WLI-R•• ..... 595
13SLN ..... 566	14WI-G•• ..... 595	150-DL-•• ..... 160	16-••• ..... 450, 454
13SN ..... 566	14WI-R•• ..... 595	150-DP-•• ..... 149	16-•••A ..... 454
13WGC•• ..... 566	14WLI-G•• ..... 595	150-DP-ALH ..... 149	1610-10 ..... 751
13WGC100-150 ..... 566		150DWPST•• ..... 161	163••00C ..... 672

	Page #		Page #		Page #		Page #
1630-00CLF	672	171C-....	715	1-HR1004	882	200E-90..	159
164C-..	714	172...C	663	1-HR1004-3	882	200-E-ALH	142
164C-...-...	714	172C-....	714	1-HR1004A	882	200-E-HA	150
165-....	661	174-....	660	1WAYBV...	542	200ENOSSS	144
165...C	661	1740...C	660	1WAYBV...SW	542	200-F-..	145
165...CLF	661	176-....	663	1WAYBV...VIC	542	200F90AL	159
165C-..	714	1760...C	663			200F-90SS	159
166-....	660	1765A	220	2.....	280	200-F-ALH	145
166...C	660	176C-0402	715	2•	280	200-F-HA	150
166...CLF	660	177-....	215	2••	273	200-G-..	168, 169
166FSV-..	718	177...C	215	2•••	273	200-G-...•	168, 170
169-....	665	177...SS	215	2••••	255, 264	200GPC••	40
1690...C	665	177...SS	215	2•••••	423-425	200GTF••	169
169C-....	713	177C-0402	714	2•••R	273	200GTFACC	170
16A-G••	591	178...C	210, 236	2••R	273	200GTHK	168
16AI-14I••	596	178...SS	210	200...C	218	200-HRP-..	165
16AI-14I••R	596	1780•0•CLF	210	2000L	47	200-HSCRIP-SI	165
16AI-15I••	596	179-....	215	200-A-..	131	200-LH-..	165
16AI-15I••R	596	179...C	215	200A-90••	157	200-PC-..	40
16AMP-G•••	569	179...SS	215	200-AA-..	154	200PRSC••	171
16AMP-G••••	569	179...SS	215	200-A-ALH	131	200-PV-9	47
16AMP-G•••••	569	1790...CLF	215	200-A-HA	150	200-TCA-..	58
16AMP-R•••	569	1790604BARB	215	200-AL-..	160	200TP	906
16AMP-R••••	569	179C-....	713	200-AL-SSANSI	160	200YDAAAL	164
16AMP-R•••••	569	18-...•	461, 462	200AWBPST••	162	2010-DA-..	152
16AMP-R••••••	569	18-...•••	425, 427	200AWSP••	162	2015-A-..	155
16AMP-R•••DIN	585	18•57	434	200-B-..	132	2015-B-..	155
16AMP-R••SMS	586	180...F	233	200B-90••	158	2015-B-ALNST	183, 786
16AMV-G•••	600	180...FSS	233	200-B-ALH	132	2015-C-..	155
16AMV-R•••	600	182...S	233	200-C-..	108, 134	2015-D-..	156
16AQ-G•••	596	182...SS	233	200C-90••	158	2015-DA-..	152
16-DBHU-16	708	183...K	231	200-C-ALH	134	2015-E-..	156
16-DCAP	710	183...KSS	231	200CNOSSS	135	2015-F-..	156
16-DELU-16	709	184...A	232	200-D-..	139	2025-DA-..	152
16-DFC-..	707	18-458-00017	835	200D-90••	158	2025-D-ALNST	183, 786
16-DFE-16	708	185-....	232	200DA-45••	157	2025-F-ALNST	183, 786
16-DFPLUG	710	185...K	232	200DA-90••	157	2030-A-..	155
16-DMC-..	707	187.....	76	200-D-ALH	139	2030-AA-..	154
16-DME-..	708	187-....	232	200DBAL	755	2030-B-..	155
16-DTTM-..	709	187...K	232	200-DC-..	146	2030-DA-..	152
16-DTTT-..	709	188-..	527	200-DC-ALH	146	2030-DD-..	154
16-DU	708	189.....	750, 800	200DC-L••	147	2030-F-..	156
16SFO	526	189DH	800	200-DD-..	154	2040-AA-..	154
16SFXO	526	19-...•	462	200DD-45••	157	2040-DA-..	152
16STDP-A	481	1910-12	751	200DD-90••	157	206.....	76
16STF16-SS	479	1BRBF•-B-7	325	200-DL-..	160	207BH•	677
16ST-SKIT	481	1BRF•-B-7	325	200-DP-..	149	207BH••	677
17-...•	451, 454	1BRGM•-B-7	325	200-DP-ALH	149	20SFO	526
17-...A	454	1BRM•-B-7	325	200DWBPST••	161	20SFXO	526
17-016-107	422	1BRS••-B-7	325	200DWSP••	161	211-...C	672
170C-....	713	1HDP	454, 469	200-E-..	109, 142	212.....	76

Part Number Index

Index  
Part Number

Page #	Page #	Page #	Page #
213••00CLF ..... 671	2501•••• ..... 513	280••••CBC ..... 225	2-DTMT-2 ..... 709
2143SEALBU ..... 29	2501•••• ..... 513	282•••• ..... 226	2-DTTM-2 ..... 709
219•••• ..... 672	2503•••• ..... 514	282••••C ..... 226	2-DU ..... 708
219••00C ..... 672	2503•••• ..... 514	282••••CBC ..... 226	2FB•-B ..... 315
21MP-G•• ..... 571	2503•••• ..... 514	284•••• ..... 227	2FBF•-B ..... 312
21MP-G•••• ..... 571	250-A•• ..... 131	286•••• ..... 227	2FF•-B ..... 312
21MP-G••••• ..... 571	250-B•• ..... 132	287•••• ..... 228	2FF•-S ..... 312
21MP-R•• ..... 571	250-C•• ..... 134	287••••C ..... 228	2FF2 ..... 312
21MP-R••• ..... 571	250-D•• ..... 139	287••••CBC ..... 228	2FM•-B ..... 313
21MP-R•••• ..... 571	250-DC•• ..... 146	287••••SS ..... 228	2FM2 ..... 313
21MP-R••••• ..... 571	250-DP•• ..... 149	287••••SS ..... 228	2FS•-B ..... 314
21MP-R••••• ..... 571	250-E•• ..... 142	2870407CLF ..... 228	2FS•-S ..... 314
2210-14 ..... 751	250-F•• ..... 145	288•••• ..... 228	2FS2.5-B ..... 314
2211CBB•••••4 ..... 628	250-G•• ..... 168, 169	288••••C ..... 228	2-HR1004-3 ..... 882
2211CBB•••••F1 ..... 628	250-G••• ..... 168, 170	288••••CBC ..... 228	2-HR1005 ..... 882
2211EBB•••••F1 ..... 629	250GTF•• ..... 169	288••••SS ..... 228	2J••-B ..... 317
2211EBB•••••F4 ..... 629	250GTHK ..... 168	289•••• ..... 228	2JB•-B ..... 317
2221CBB•••••F1 ..... 628	2510-16 ..... 751	289••••C ..... 228	2JF•-B ..... 317
2221CBB•••••F4 ..... 628	2520-DA•• ..... 152	289••••SAE ..... 228	2JS•-B ..... 317
2221EBB•••••F1 ..... 629	2530-AA•• ..... 154	2890••••SAE ..... 228	2L•2-B ..... 322
2221EBB•••••F4 ..... 629	2530-DA•• ..... 152	290•••• ..... 229	2MF•-B ..... 318
225 ..... 76	2540-AA•• ..... 154	290••••C ..... 229	2MF•-PL ..... 318
228•••• ..... 670	25H••• ..... 589	2909••••CBC ..... 229	2MM•-B ..... 319
228••••C ..... 670	25H••••• ..... 589	292••••C ..... 229	2MM•-PL ..... 319
22MP-G•• ..... 572	2601•••• ..... 514	292••••CBC ..... 229	2MS•-B ..... 319
22MP-G•••• ..... 572	2601••••• ..... 514	292-0•• ..... 229	2MS•-PL ..... 319
22MP-G••••• ..... 572	2601•••••• ..... 514	294•••• ..... 229	2MS2.5-PL ..... 319
22MP-R•• ..... 572	2603•• ..... 514	294••••C ..... 229	2NKS2 ..... 324
22MP-R••• ..... 572	2603••• ..... 514	294••••CBC ..... 229	2SHD•• ..... 321
22MP-R•••• ..... 572	268B•••• ..... 212	294••••SS ..... 229	2SHDS• ..... 322
22MP-R••••• ..... 572	269C•••• ..... 713	296••••C ..... 225	2U••-B ..... 323
22MP-R••••• ..... 572	2700LN•• ..... 515	296••••CBC ..... 225	2WAYBV•• ..... 543
230FXF••00000 ..... 50	2700LN••• ..... 515	296••••SS ..... 225	2WAYBV•••SW ..... 543
233 ..... 750, 799	2701LN•• ..... 516	2CJBF•-B ..... 320	2WAYBV••VIC3 ..... 543
234-80•• ..... 846	2701LN••• ..... 516	2CJBM•-B ..... 320	2WCA••••F• ..... 815
2404••• ..... 511	270AT ..... 230	2CJF•-B ..... 320	2WCA••••F-SP• ..... 815
2404•••• ..... 511	271•••• ..... 223	2CJF2-B ..... 374	2WSA••••F ..... 815
2404••••• ..... 511	271••••C ..... 223	2CJM•-B ..... 320	2WSA••••F•• ..... 815
2405••• ..... 511	272••••C ..... 223	2CM4S2.5-B-E ..... 504	3 ..... 280
2405•••• ..... 511	272••••SS ..... 223	2CM9S2.5-B ..... 505	3•• ..... 273
2405••••• ..... 511	272••••W ..... 230	2CM9S2.5-B-E ..... 505	3•• ..... 258, 259, 273
2405••••• ..... 511	2720••CLF ..... 223	2CMS2.5-B ..... 503	3••• ..... 258, 259, 264
24PFX••• ..... 103	273•••• ..... 224	2CMS2.5-B-E ..... 503	3•••• ..... 422, 424, 425
24SFO ..... 526	273••••C ..... 224	2D••-B ..... 312, 313, 315	3•••R ..... 273
24SFXO ..... 526	274••••C ..... 224	2D••-S ..... 312, 313	3••R ..... 273
250 ..... 76	274••••CBC ..... 224	2DB••-B ..... 312	30••• ..... 494
2500HB0000 ..... 99	275 ..... 76	2DB•-B ..... 315	30•••DP ..... 495
2500L ..... 47	278••••C ..... 225	2-DFC•• ..... 707	30••RDSSAP ..... 41
2500SFV ..... 48	2789••••CBC ..... 225	2-DMC•• ..... 707	300••• ..... 526
2501••• ..... 513	280•••• ..... 225	2DS•-B ..... 314	300•••• ..... 526
2501•••• ..... 513	280••••C ..... 225	2DS•-S ..... 314	

	Page #		Page #		Page #		Page #
300-...	526	300EL90..	664	3020-DA..	152	3140....	353, 354, 360
3000....	354	300EL90..	664	3020DAT..SS	153	3140....DOT	335
3002....	445	300ENOSSS	144	3020-E..	156	31440-225AL	29
300300MAE	44	300-F..	145	3020-F..	156	3148....	352
3004....	445	300F-90SS	159	3020-RD..	40	3148....DOT	335
3004030MAE	44	300-F-ALH	145	3025-A-ALNST	183, 786	31665660DOT	334
3006....	445	300-F-HA	150	3025-B-ALNST	183, 786	3175....	350, 354, 358
3009....	351, 445	300FT..	668	3025-C..	155	31825600DOT	334
300-A..	131	300FT..	668	3025-DA..	152	31835600DOT	335
300A-90..	157	300-G..	168, 169	3025-D-ALNST	183, 786	3199....	360
300-AA..	154	300-G....	168, 170	3025-E..	156	3210-20	751
300-A-ALH	131	300GPC..	40	3025-F-ALNST	183, 786	322-....	668
300-A-HA	150	300GTF..	169	30-300F	494	322....C	668
300-AL..	160	300GTFACC	170	304....C	665	322....CLF	668
300-AL-SSANSI	160	300GTHK	168	3040..CLF	665	324-....	670
300-ALT..	36	300GTHKBF	169	3040-A..	155	324....C	670
300ASSSAP	41	300GTTFBL	37	3040-AA..	154	3240606CLF	670
300AWBPST..	162	300GTTFCB	37	3040ALTAL	36	326-....	670
300AWSP..	162	300GTTFK	37	3040-B..	155	326....C	670
300-B..	132	300GTTFTK	37	3040-C..	155	3260404CLF	670
300B-90..	158	300H-PADBR	166	3040-DA..	152	32P-LJ15	89
300-B-ALH	132	300H-PADSS	166	3040-DD..	154	32P-SO15	89
300BR....	654	300-HRP..	165	3040DLTAL	36	32PFX..	103
300-C..	108, 134	300-HSCRPSI	165	3040-F..	156	32SFO	526
300C-90..	158	300-LH..	165	306.....	76	32SFXO	526
300-C-ALH	134	300-MAE	44	306....	667	330FXF..00000	50
300CNOSSS	135	300MICAP..	671	3060-DA..	152	33155614	354
300-D..	139	300MICAP..	671	31..	367	340-....	526
300-D-ALPH	45	300MIU..	657	31....	494	35..	328
300D-90..	158	300MIU..	657	31...DC	495	35-....	243
300DA-45..	157	300-PC..	40	3101....	359	35-...10	561
300DA-90..	157	300PC..AP	41	3102....	353, 360, 445	35..WF	328
300-D-ALH	139	300PRSC..	171	3102....DOT	333	35..WF2	328
300DAT..SS	152	300RHC..	656	3103....	352	350.....	76
300DBAL	755	300RHC..	656	3103....DOT	335	3533..	163
300-DC..	146	300-SFC..	40	3104....	353, 354, 360, 445	3534..	163
300-DC-ALH	146	300SSSG	860	3104....DOT	334	3543..	163
300DC-L..	147	300-TCA..	58	3106....	353, 354, 359	3544..	163
300-DD..	154	300-TFA	46	3106....DOT	333	3601....	348
300DD-45..	157	300-TFG	44	3108....	352, 359	3602....	349
300DD-90..	157	300TP	906	3108....DOT	334	3604....	349
300-DL..	160	3010-RC-SS	40	3109....	351, 354, 358	3606....	348
300-DLT-AL	36	3014....	350	3109....DOT	333	3615....	348
300-DP..	149	3015-DA..	152	3113....	351	3675....	348
300-DP-ALH	149	3015-F..	156	3114....	358	370....C	662
300DWBPST..	161	302....C	664	3114....DOT	332	3700..CLF	662
300DWSP..	161	302....CLF	664	3115....DOT	332	3701212C	365
300-E..	109, 142	3020-A..	155	3116....	353, 359	3710..C	657
300E-90..	159	3020-B..	155	3116....DOT	333	3710..CLF	657
300-E-ALH	142	3020-C..	155	3126....	353, 360	373....C	659
300-E-HA	150	3020-D..	156	3129....	351	373....CLF	659

Part Number Index

Page #	Page #	Page #	Page #
375.....76	3U•-B .....323	400DWPST•• .....161	4055-3 .....751
375••••C .....659	4.....280	400DWSP•• .....161	4060-A•• .....155
375••••CLF .....659	4•• .....273, 279	400DWX5TC .....57	4060-AA•• .....154
377••••C .....655	4••• .....275	400-E•• .....109, 142	4060-DA•• .....152
377••••CLF .....655	4•••• .....422-427	400E-90•• .....159	4060-DD•• .....154
379••••C .....662	4••••• .....423-426	400-E-ALH .....142	40A-45TCAL .....58
38025600.....347	4•••••R .....422, 423, 425	400-F•• .....145	40BS-H•• .....593
3804•••• .....347	4•••••RF .....422	400-F-ALH .....145	40BS-O•• .....593
3805•••• .....346	4•••••RL .....425	400-G•• .....168, 169	40BS-S•• .....593
3806•••• .....346	4••R .....273	400-G••• .....168, 170	40IE••• .....597
3810-24 .....751	40••REV90 .....811	400GAGFI .....164	40IH••• .....597
3816•••• .....346	400•-ALGT .....30	400-G-BUSS .....56	40IT••• .....597
3889•••• .....347	40022ALTAL .....36	400GPCTF .....40	40IV••• .....598
390-••• .....526	40022DLTAL .....36	400GTF•• .....169	40MP-E••• .....578
390-•••• .....526	400-A•• .....131	400GTHK .....168	40MP-EZ••• .....583
391137.....845	400-A••INSERT .....131	400GTHKBF .....169	40MPF-E••• .....581
3CJBF•-B .....320	400A-90•• .....157	400GTTFBL .....37	40MPF-E•••• .....581
3CJBM•-B .....320	400-AA•• .....154	400GTTFCB .....37	40MPF-SFY•• .....581
3CJF•-B .....320	400-A-ALH .....131	400GTTFK .....37	40MPF-SFY•••• .....581
3CJM•-B .....320	400-AA-MI .....154	400GTTFTK .....37	40MPF-U••• .....580
3D••-B .....312, 313, 315	400-AL•• .....160	400-LH•• .....165	40MPF-U•••• .....580
3D••-S .....312, 313	400-ALT•• .....36	400-PC•• .....40	40MPF-UW••• .....580
3DB••-B .....312, 313	400-AS-AL .....164	400-TCA•• .....58	40MPF-XW••• .....581
3DS•-B .....314	400AWBPST•• .....162	400-TLT-AL .....35	40MPF-XW•••• .....581
3DS•-S .....314	400AWSP•• .....162	400TP .....906	40MP-G••• .....580
3FB• .....315	400-B•• .....132	401.....76	40MP-G•••• .....580
3FBF3 .....312	400-B-ALH .....132	401-01 .....444	40MP-GR••• .....582
3FBM3 .....313	400-C•• .....108, 134	401-01S .....444	40MP-GRE••• .....582
3FF• .....312	400-C••INSERT .....134	4020-DA•• .....152	40MP-SFY••• .....579
3FF3-S .....312	400C-90•• .....158	4025-DA•• .....152	40MP-SFYZ••• .....583
3FM• .....313	400-C-ALH .....134	4030-A•• .....155	40MPS-U••• .....582
3FS3-S .....314	400-CVR-AL .....33	4030-B•• .....155	40MP-U••• .....578
3-HR1004-3 .....882	400-D•• .....139	4030-C•• .....155	40MP-U•••DIN .....588
3-HR1005 .....882	400-D•-ALPH .....45	4030-CVR-AL .....33	40MP-U•••RJT .....588
3J•• .....317	400D-90•• .....158	4030-D•• .....156	40MP-U•••SMS .....588
3JB• .....317	400DA-45•• .....157	4030-DA•• .....152	40MP-UW••• .....578
3JF• .....317	400DA-90•• .....157	4030-DAVR-AL .....33	40MP-UZ••• .....583
3JS• .....317	400-D-ALH .....139	4030-DVR-AL .....34	40MPV-G••• .....603
3MF3-PL .....318	400-DC•• .....146	4030-E•• .....156	40MPV-U••• .....603
3MM•-PL .....319	400-DC-ALH .....146	4030-F•• .....156	40MP-XC••• .....579
3MS3-PL .....319	400DC-L•• .....147	4030-MAE .....44	40MP-XW••• .....579
3NBM4 .....294	400-DD•• .....154	4030-RD•• .....40	40PFX••• .....103
3NCS4 .....294	400DD-45•• .....157	40321TF .....37	40QH••• .....598
3NM4 .....294	400DD-90•• .....157	40322TF .....37	40QT••• .....598
3N-SKIT .....295	400DDVR-AL .....33	40323BL .....37	40SFO .....526
3S•-15U-GFB•SS .....620	400-DL•• .....160	40323TF .....37	41440-225AL .....29
3S•-2U-GFB•SS .....620	400-DLT-AL .....36	40364BL .....37	41450-DCAL .....29
3TF3 .....494	400-DP•• .....149	40364TF .....37	4-1460-AL .....37
3TM3-PV .....494	400-DP-ALH .....149	4050-AA•• .....154	418.....76
3TM3-SS .....494	400-DVR-AL .....34	4050-DA•• .....152	41FL• .....719
3TM3-SS-PV .....494		4050-DD•• .....154	41FS• .....719

	Page #		Page #		Page #		Page #
4215-..	426	48PFX-...	103	4NS-B-WF	296	500-DP-..	149
42777-000	439	48SFO	526	4NS-S	294	500DWBSTAL	161
42F-.	718	4D-B	312, 313	4NS-SS	294	500DWSP-.	161
42MP-E-.	578	4D-S	312	4NS-WF	296	500-E-.	142
42MP-G-.	580	4DB-B	312	4N-SKIT	295	500-F-.	145
42MP-GRE-.	582	4-DBHU-4	708	4P-	90	500-G-.	168
42MP-SFY-.	579	4-DCAP	710	4PF-	297	500GH4VBK	245
42MP-U-.	578	4-DELU-4	709	4PF-FS	298	500GHV	244
42MP-UW-.	578	4-DFC-.	707	4PF6-B	297	500GHY	244
42MP-XC-.	579	4-DFE-2	708	4PF6-S	297	500GTCABF	59
42MP-XW-.	579	4-DFPLUG	710	4PM-FS	298	500GTCABU	59
430FXF-00000	50	4-DMC-.	707	4PS-	298	500GTCATF	59
430TFTFLAL-....	53	4-DME-.	708	4PS-B	298	500GTCATV	59
430TFXTFAL-....	53	4-DRATT-2	708	4PS-FS	298	500GTCAVI	59
4315-..	426	4DS-B	314	4PS-WF	299	500GTCAVITHK	59
4316-50	426	4DS-S	314	4PS6-9	298	500GTFWB	169
4328-50	426	4-DTMT-4	709	4PS6-S	298	500QCF	243
43HTFTFLAL-....	53	4-DTTF-4	709	4PSG	38	500QCFSS	243
43HTFXTFAL-....	53	4-DTTM-4	709	4RKOBV	53	500QCFV	243
440TFXTFAL-....	53	4-DTTT-4	709	4RKOVIVI	53	500QCFVOR	243
44-251-00006	830	4-DU	708	4SHD-.	321	500QCFVSG	243
44HTFXTFAL-....	53	4-DU-2	708	4SHDS-	322	500QCK	243
450.....	76	4EA-SKIT	501	5.....	280	500QCKSS	243
4500-5	29	4FAMT	83	5-.	273, 279	500QCKV	243
4500RK	29	4FAMTL	83	5-..	272	500QCM	243
4500RK-V	29	4FB-	315	5-....	424	500QCMSS	243
450-4S	891	4FBF4	312	5-....	422-425, 427	500QCSG	243
450TFXTFAL-....	53	4FBM4	313	5-...LP	881	500YC	244
4510-28	751	4FF-	312	5-..R	273	501-...C	241
452-..	368	4FF4-S	312	500-....	445	502-...CLF	241
4530.....	29	4FM-	313	5000-.	519	50212-..C	241
4530SG	29	4FS-	314	5000-..	519	50212-..SS	241
4540.....	29	4FS4-S	314	5000-..	519	5030-DA-..	152
4540DC	30	4HF4-HV	453	5000-...-	519	50312-..C	241
4540DC-1200	30	4-HR1005	882	5000-....	519	504-....	241
4540F	29	4K-.-DP	460	5000-24	29	5040-C-..	155
4540SG	29	4KDP	460	5000-24L	29	5040-D-..	156
4540SG-RK-	29	4N4N	295	5000-25	29	5040-DA-..	152
45CIPUSH	904	4NBF-	293	500-A-..	131	5040-E-..	156
45HTFXTFAL-....	53	4NBF-B	293	500-AA-..	154	50412-..C	241
46-003-00001	792	4NBM-	294	500AN-	754, 862	50412-..SS	241
46-011-00418	792	4NBM-B	294	500-AN7	754, 862	5060-AA-..	154
46-030-00025	830, 835, 837	4NF-	293	500AWBPST-.	162	5060-DA-..	152
46F-..	717	4NF-B	293	500AWSP-.	162	5061212C	241
46F-...-	717	4NF-SS	293	500-B-..	132	5061212CLF	241
4895-....	357	4NM-	294	500BFP	245	507-....	240
48F-..	717	4NM-B	294	500-C-..	134	50712-..C	240
48F-...-	717	4NM-SS	294	500-D-..	139	5071208SS	240
48F-....	717	4NM6-S	294	500DA-90-.	157	5071212CLF	240
48P-LJ15	89	4NS-	294	500-DC-..	146	50812-..C	239
48P-SO15	89	4NS-B	294	500-DD-..	154	50812-..SS	239

Part Number Index

Index Part Number

Page #	Page #	Page #	Page #
5081208CLF ..... 239	5406-... .. 518	6.. ..... 279, 343, 344	60C-.. ..... 715
509-.... ..... 240	5406-... .. 518	6... ..... 343, 344	60NAB. .... 339
509-12C ..... 240	5406C. .... 522	6.... ..... 673, 675, 677, 703	60NAB.. .... 339
5091212CLF ..... 239	5406C-.. .... 522	6... .. 423	60PT-.. .... 716
5091212SS ..... 240	5500. .... 519	6.... .. 427	60RB-.. .... 341
50-A-.. ..... 131	5500-.. .... 519	600-... .. 526	61-... .. 558
50-B-.. ..... 132	5502. .... 520	6000-.. .... 42	61C-.. ..... 716
50-C-.. ..... 134	5502-.. .... 520	6000-C ..... 43	61CL-.. .... 716
50-D-.. ..... 139	5504. .... 520	6000ASAL ..... 44	61NAB. .... 340
50-DC-.. ..... 146	5504-.. .... 520	6000-SSA ..... 44	61NAB.. .... 340
50-DP-.. ..... 149	56-... ..... 459, 460	600-A-.. ..... 131	61RB-.. .... 341
50-E-.. ..... 142	5600. .... 521	600-AA-.. ..... 154	61RBSG-.. ..... 340
50-F-.. ..... 145	5600-.. .... 521	600-A-ALH ..... 131	6200..... 42
50-G-.. ..... 168, 169	5601. .... 521	600-AL-.. ..... 160	6200. .... 42
50-G-TF-VI ..... 169	5601-.. .... 521	600-ALT-AL ..... 36	6200-.. .... 42
50-HP-SP ..... 165	5602. .... 521	600AWBPST.. ..... 162	62C-.. ..... 712
5110-32 ..... 751	5602-.. .... 521	600AWSP.. ..... 162	62C-.... ..... 712
5111A ..... 220	5604. .... 521	600-B-.. ..... 132	62CBH-.. ..... 712
5131212C ..... 242	5604-.. .... 521	600-B-ALH ..... 132	62NAB. .... 337
5141212C ..... 239	5605. .... 521	600-C-.. ..... 108, 134	62NAB.. .... 337
5141212CLF ..... 239	5605-.. .... 521	600C-90.. ..... 158	62NABH. .... 337
5141212SS ..... 239	56RBSG-.. ..... 340	600-C-ALH ..... 134	62NBH. .... 337
520-.... ..... 445	57-... ..... 459, 460	600-D-.. ..... 139	62NBH.. .... 337
5200-SFI ..... 37	572-.... ..... 226	600D-90.. ..... 158	62NFBH. .... 337
5200-SFI-3 ..... 37	572-...C ..... 226	600DA-45.. ..... 157	62NFBH.. ..... 337
5200-SFI-3-RK1 ..... 38	574-.... ..... 226	600DA-90.. ..... 157	6302-...WP2 ..... 726
5200-SFI-3V-RK1 ..... 38	574-...C ..... 226	600-D-ALH ..... 139	6304-...WP2 ..... 726
5200-SFI-RK1 ..... 38	575-.... ..... 226	600-DC-.. ..... 146	63046056WP2 ..... 726
5200-SFIV-RK1 ..... 38	575-...K ..... 226	600-DC-ALH ..... 146	6306-...WP2 ..... 726
5201-SFI ..... 37	578-...C ..... 236	600DC-L.. ..... 147	6315-...WP2 ..... 725
5201-SFI-RK1 ..... 38	585-12C ..... 235	600-DD-.. ..... 154	6316-...WP2 ..... 726
5204..... 28	586-12C ..... 235	600DD-45.. ..... 157	6322-...WP2 ..... 728
5204LNG ..... 28	587-...K ..... 235	600DD-90.. ..... 157	6325-...WP2 ..... 725
5204LSNG ..... 28	588-12C ..... 235	600-DL-.. ..... 160	6326-...WP2 ..... 727
5204LSNGP ..... 28	589-...K ..... 235	600-DLT-AL ..... 36	6340-...WP2 ..... 726
5204NG ..... 28	59-... ..... 703	600-DP-.. ..... 149	6351-...WP2 ..... 727
5205-RK4 ..... 29	59-1616C ..... 202	600-DP-ALH ..... 149	6366-...WP2 ..... 728
5300..... 28	590-...C ..... 234	600DWPSTAL ..... 161	6382-...WP2 ..... 728
5300B ..... 28	590-12CLF ..... 234	600DWSP.. ..... 161	6388-...WP2 ..... 728
5300BC ..... 28	591-...C ..... 234	600-E-.. ..... 109, 142	639C-04 ..... 715
5300G ..... 28	591-12CLF ..... 234	600-E-ALH ..... 142	63NAB. .... 340
5354K21 ..... 28	591-12SS ..... 234	600-F-.. ..... 145	63PT-.... ..... 715
5400..... 28	5911-1-W ..... 242	600-F-ALH ..... 145	640-... .. 526
5400B ..... 28	5911212F ..... 242	600-G-.. ..... 168, 169	6400..... 43
5400G ..... 28	5911212N ..... 242	600GTFVI ..... 169	6401-.. .. 508
5404. .... 518	592-...K ..... 234	600-HRP-.. ..... 165	6401-... .. 508
5404-.. ..... 518	5921212KLF ..... 234	6030-DA-.. ..... 152	6401-... .. 508
5404-... .. 518	595-...K ..... 237	6040-A-.. ..... 155	6403. .... 508
5404-... .. 518	5951616K ..... 202	6040-D-.. ..... 156	6403-.. .... 508
5404-... .. 518	6..... 280	6040-DA-.. ..... 152	6405-.. .. 509
5404-... .. 518		6050-DA-.. ..... 152	6405-... .. 509

	Page #		Page #		Page #		Page #
6405-...	509	66NBH86	337	70-X	343	7770-...	356
6408HHP-	510	67RBSG-	341	70-X	343	7775-...	356
6408HHP-	510	68-X	342	700013-...	368	78-...	487, 488
6410-	508	68-X	342	7065-...	355	78-...	487
6410-	508	68-X	342	70NAB-	337	7800MP	881
6410-...	508	68-X	342	70NAB-	337	79-...	488
6410-40	751	6803-	510	71-X	345	79-...	488
64NAB-	339	6803-	510	71-X	345	7910-...	355
64NAB-	339	682C-...	713	71-X	345	7982-...	355
64P-LJ15	89	688-	527	71NAB-...VS	339	7994-...	357
64P-SO15	89	68C-...	711	71NAB-...VS	339	7996-...	357
64PFX-...	103	68CIPUSH	904	71S-X	345	79NAB-...VS	338
6500	42	68NAB-...VS	336	71S-X	345	79NAB-...VS	338
6500-	512	68NAB-...VS	336	71S-X	345		
6500-	512	68NAB-...VS	336	71S-X	345		
6500-	512	68RB-...B	341	72-X	344	8	280
6500-...	512	68RBSG-...	341	72-X	344	8-	279, 343
6500-...	512	69-X	343	72-X	344	8-	245, 343, 862
6500A	42	69-X	343	72NAB-...VS	339	8-	861
6501-	513	69-X	343	72NAB-...VS	339	8-H	861
6501-	513	69-X	343	72S-X	345	8-LP	882
6501-...	513	690-...	526	72S-X	345	800-A-	131
6502-	513	6901-	509	72S-X	345	800-AL-	160
6502-	513	6901-	509	750	76	800AWSPAL	162
6503-...WP2	727	6901-...	509	7550-A-	131	800-B-	132
650-4S	891	6901-...	509	7550-E-	142	800-C-	134
6505-	512	69NAB-...VS	338	7550-F-	145	800-D-	139
6505-	512	69NAB-...VS	338	75-A-	131	800-DC-	146
6505-...	512	69NAB-...VS	338	75AWBPSTSS	162	800-DL-	160
6505-...WP2	725	69S-X	344	75AWSPSS	162	800-DP-	149
6506-	512	69S-X	344	75-B-	132	800DWSPAL	161
6506-	512	69S-X	344	75-C-	134	800-E-	142
6506-...	512	6D-B	312	75-D-	139	800-F-	145
650-6S	891	6-DBHU-6	708	75-DC-	146	800-G-	168
6508-...WP2	727	6-DCAP	710	75-DP-	149	800-HNP-BR	165
6509-...WP2	727	6-DELU-6	709	75DWBPSTSS	161	801-A-	131
6530A	42	6-DFC-	707	75DWSPSS	161	801AWBPSTAL	162
6530C	42	6-DFE-4	708	75-E-	142	801AWSPAL	162
6579-...WP2	725	6-DFPLUG	710	75-F-	145	801-DP-	149
65NAB-	338	6-DMC-	707	75-G-	168, 169	801-E-	142
65NAB-	338	6-DME-	708	75-G-	168, 170	801-F-	145
66-X	342	6-DRATT-	708	75GTFACC	170	8060-DA-	152
66-X	342	6DS-B	314	75-G-TF-VI	169	80B-100HAF	739
66-X	342	6-DTMT-4	709	75-HP-SP	165	80B-100HCF	739
6600-	514	6-DTTT-6	709	75TH2R-...SS	446	80B-50HAF	739
6600-	514	6-DU	708	7600HP	881	80B-50HCF	739
6602-	514	6-DU-4	708	7610-48	751	8320605	861
6602-	514			7660-...	356	850	76
66C-...	712	7	280	7665-...	356	850-	100
66NAB-	336	7-	279	77-...	488	851-	368
66NAB-	336	7-...LP	881	77-...	488	855	221
						855231	299



Part Number Index

Page #	Page #	Page #	Page #
855A ..... 221	90IRC4025G ..... 806	A5...UC ..... 733	ADS400 ..... 164
856- ..... 221	90IRC4025GF ..... 806	A5...50RAF ..... 750	ADS4GR ..... 64
856... ..... 221	90ISCS4025F ..... 808	A5...U...CBF ..... 733	ADV150F ..... 840
860..... 222	90PPA... ..... 188	A510100... ..... 733	AFC...F-TGWP ..... 791
861... ..... 222	90PPC... ..... 188	A510-50... ..... 733	AFN... ..... 760
875-4 ..... 846	90PPD... ..... 188	A515100... ..... 733	AFN...NST ..... 760
875-5 ..... 846	90PPF... ..... 188	A515-25... ..... 733	AG... ..... 689
8-DBHU-8 ..... 708	90SCS4025F ..... 808	A515-50... ..... 733	AG-BF... ..... 462
8-DCAP ..... 710	90TCS...F ..... 810	A515-75... ..... 733	AG-BF-PV ..... 462
8-DELU-8 ..... 709	90TCS...F... ..... 810	A515OR50RAF ..... 734	AG-DC ..... 462
8-DFC- ..... 707	915... ..... 528	A515OR50RAS ..... 734	AG-F... ..... 462
8-DFE-8 ..... 708	94...U... ..... 305	A515R50RAF ..... 734	AG-F-PV ..... 462
8-DFPLUG ..... 710	968..... 76	A515Y50RAF ..... 734	AG-OF... ..... 462
8-DMC- ..... 707	96P-LJ15 ..... 89	A525100... ..... 733	AG-OF-PV ..... 462
8-DME-8 ..... 708	96P-SO15 ..... 89	A525-25... ..... 733	AH... ..... 147
8-DRATT-12 ..... 708	A... ..... 288	A525-50... ..... 733	AH...EZ ..... 148
8-DTMT- ..... 709	A... ..... 288	A525-75... ..... 733	AHA...ADP ..... 785
8-DTTM- ..... 709	A...00F...DA ..... 63	A7... ..... 699	AHA...BSP...T ..... 659
8-DTTT-8 ..... 709	A...VC...MG ..... 730	A7... ..... 699	AHDBF75 ..... 561
8-DU ..... 708	A100C...A ..... 61	A800OG... ..... 64	AHGV250 ..... 828
8SFO ..... 526	A100CA1050 ..... 65	A800OGJ... ..... 64	AHGV250F ..... 828
8SF XO ..... 526	A100CA1050V ..... 65	AAPN75GHT ..... 765, 863	AHGV250F-H ..... 828
8STBF8-V2 ..... 479	A100CBLMTR ..... 65	AB... ..... 283	AHGV250F-I ..... 828
8STDP-A-V2 ..... 481	A100D... ..... 65	AB... ..... 283, 284	AHW ..... 799
8STF10-V2 ..... 479	A100LT ..... 65	AB... ..... 133	AHWPT ..... 800
8STF8-V2 ..... 479	A100MTR ..... 65	AB...EZ ..... 133	AK3526-300FL ..... 757
8ST-SKIT-V2 ..... 481	A100SG-POLY ..... 65	ABC... ..... 236	AK4450NST ..... 757
8WF8-HN ..... 487	A100TT... ..... 65	ABC250 ..... 790	AKSP1 ..... 289
9... ..... 279	A200CA3P... ..... 64	ABH...F ..... 743	AKSP25 ..... 289
900..... 846	A200CA5P... ..... 64	ABN100... ..... 761	AL... ..... 866-868, 871, 872
900... ..... 846	A200PC...A ..... 63	ABN150... ..... 761	AL...XX ..... 866
900...34 ..... 846	A200PCSS...A ..... 63	AC... ..... 135	AL455F ..... 868
9000-48S ..... 375	A200PCSSDP...A ..... 63	AC...EZ ..... 137	AL9 ..... 865
900SK ..... 846	A200PHC...A ..... 63	AC1 ..... 289	ALC...EZ ..... 128
900TK ..... 846	A200SA ..... 65	AC200TUBE ..... 163	Alpha Numeric.....
900W... ..... 846	A200SVA ..... 65	AC7 ..... 172	ALTG...F ..... 907
9076M ..... 368	A210...120 ..... 62	ACB304 ..... 261	AL-TPR... ..... 871
90CDMHCB... ..... 812	A210...24 ..... 62	ACL... ..... 173	AM... ..... 283, 365
90CREV... ..... 811	A210-120 ..... 62	ACL8 ..... 289	AM... ..... 283, 284
90DCS...F ..... 809	A210-120TC ..... 65	ACPSO150 ..... 761	AM...WF ..... 287
90DCS...F... ..... 809	A210-24 ..... 62	ACPSO150F ..... 761	AM-SWIV ..... 287
90DCS...NYFD ..... 809	A210CR... ..... 65	AD... ..... 140	AM11WF ..... 287
90DCS4025F- ..... 809	A210PZH-24 ..... 65	AD...EZ ..... 141	AM11WF-1 ..... 287
90DCS4030NYFDSP ..... 809	A3...UC ..... 732	AD400ALEZMTC ..... 57	AM7T ..... 287
90FR3C... ..... 807	A3...UC ..... 732	AD90400... ..... 158	AMF... ..... 366
90FR3C...F ..... 807	A315100... ..... 732	ADA... ..... 153	ANH... ..... 290
90FRC... ..... 806	A315-50... ..... 732	ADA...EZ ..... 153	ANH... ..... 290
90FRC...F ..... 806	A325100... ..... 732	ADD... ..... 154	ANSI... ..... 697
90IRC... ..... 806	A325-50... ..... 732	ADD... ..... 154	ANT... ..... 763
90IRC...F ..... 806	A5...UC ..... 733	ADPW ..... 561	ANT...F ..... 763
		ADS...GR ..... 64	APN... ..... 684

	Page #		Page #		Page #		Page #
APRD•••F	837	AV250NYFD-I	823	B23BMP-R••••	569	B2WCL-G•••P	604
AQ62DOT•	330	AV251NYC	824	B24HS-G••	623	B2WCL-G•••U	610
AQ64DOT•	331	AV251NYFD	824	B24HS-G•••	623	B2WCL-R•••P	604
AQ68DOT•X•	330	AV5-250F	822	B24PS-G••	623	B2WCL-R•••U	610
AQ69DOT•X•	330	AV5-250NYFD	822	B24PS-G•••	623	B2WCL-R•••P	604
AQ69DOTS•X•	330	AVAPR•••F	838	B24PV-G•••	602	B2WCL-R•••U	610
AQ71DOTS•X•	331	AVAPR•••F-I	838	B24RG-G••	624	B2WK-G•••P	605
AQ72DOTS•X•	331	AVAPRF•••	838	B24RG-G•••	624	B2WK-G•••U	611
AR20831	872	AVAPRF•••-I	838	B24RPH-G••	624	B2WK-R•••P	605
AR3000-A2	868	AVF•••	821, 824	B24RPH-G•••	624	B2WK-R•••U	611
AR3500	871	AVF•••-I	823	B24RV-G•••	602	B2WK-R•••U	611
AR5000-1	872	AVF5-250	822	B25-G•••••	624	B2WUL-R•••P	609
AR503830SSP	880	AVG250F	822	B25-G••••••	624	B2WUL-R•••U	614
AR-BROOM16	871	AVG250G	822	B25-G•••••••	624	B2WUMP-R•••	576
AREP400AS	817	AVGF250	822	B28-••AG	392	B3114MP-G•••••	575
AR-REEL100	882	AVN••••-200	699	B28-••AGMB	392	B3114MP-R•••••	575
ARSMSA•••F	780	AWR14	289	B28-••MG	392	B3114MP-R•••••	575
ARTEL18A	867	AWR4	289	B28-••MGMB	392	B3115F-G•••••	592
ARTEL-BELT	867	AWS6	289	B28AMP-R•••	576	B31TP-G•••••	592
ASB••	290	AWSG	858	B28BMP-R•••	576	B31W-G•••••P	608
ASB•••	290	AWSG-TG	861	B28WA-R•••P	609	B31W-G•••••U	613
ASBDV••	833	AWSG-W	858	B28WA-R•••U	614	B31WMP-G•••••	568
ASC•••	290			B28W-R•••P	609	B31WMP-R•••••	568
ASHV1015F	840	B•	68, 71, 75	B28W-R•••U	614	B31W-R•••••P	608
ASP-•BV	448	B••	68, 71, 75, 76	B2CM-G•••	604	B31W-R•••••U	613
ASP310-•40	369	B••SC	70, 365	B2CMP-G•••	572	B31W-R•••••P	608
AST•	190	B07-••AG	407	B2CMP-R••	572	B31W-R•••••U	613
AST••	190	B07-••MG	407	B2CMP-R•••	572	B31W-R•••••P	608
ASTB••	191	B07-202•GC	407	B2CM-R•••	604	B31W-R•••••U	613
ASTB•••	191	B08-02AG	379	B2E-G•••	592	B3214MP-G•••••	575
ATC40ASSAPI	58	B08-02AGMB	379	B2F-G•••	592	B3214MP-R•••••	575
ATC40ASSDDA	58	B11-••WJC	429	B2FMP-14-G•••	573	B32W-G•••••P	608
ATCA40	56	B11-••WJCR	429	B2FP-G•••	604	B32W-G•••••U	613
ATCF40	56	B16-••••S	458	B2KM-G•••	605	B32W-R•••••P	608
ATCF40-90	56	B16-•••S	458	B2KMP-G•••	573	B32W-R•••••U	613
ATCG40-90	56	B16-•63	450	B2KMP-R••	573	B32W-R•••••P	608
ATCGF40	56	B16W-G•••	611	B2KMP-R•••	573	B32W-R•••••U	613
ATCS40	56	B17-••••S	458	B2KM-R•••	605	B3401-•••	523
ATCT••	57	B17-•••S	458	B2KS-G•••P	605	B3401-••••	523
ATN100X7	53	B17-•63	451	B2KS-G•••U	610	B3455-•••	523
ATS••••H	329	B18-••AG	391	B2KS-R•••P	605	B3455-••••	523
ATS7838F	329	B18-••AGMB	391	B2KS-R•••U	610	B3800-•••	523
ATS7838M	329	B18-••MG	391	B2KS-R•••P	605	B3800-••••	523
ATTFST40CS	116	B18-••MGMB	391	B2KS-R•••U	610	B3801-•••	523
AV•••	821, 824	B19MPX-R•••	601	B2S-G•••P	604	B3801-••••	523
AV••••	821	B19WB-G•••	611	B2S-G•••U	610	B38SL-G•••	615
AV•••-I	823	B19WV-R•••	601	B2S-R•••P	604	B38SL-R•••	615
AV•••-RBR	821, 824	B19WX-R•••	601	B2S-R•••U	610	B38W-R•••	615
AV•••S	821	B22WB-G•••	611	B2S-R•••P	604	B45AB-R•••	639
AV•••-W	835	B23BMP-G•••	569	B2S-R•••U	610	B45AB-R100150	639
AV•••-WR	824	B23BMP-R•••	569	B2SXL-••R•••	606	B45BC-R•••	639

Part Number Index

Page #	Page #	Page #	Page #
B45BC-R100150 ..... 639	B74G-MG-MB ..... 416	BBV-DTW ..... 538	BFNE150NST ..... 752, 855
B45BY-R... ..... 638	B7MP-G... ..... 574	BBV-DW ..... 537	BFO... ..... 914
B45BY-RK... ..... 638	B7MP-R... ..... 574	BBV-DWV ..... 537	BFP200 ..... 839
B45BY-SK... ..... 638	B7MP-R... ..... 574	BBV-FP ..... 532	BFS... ..... 213
B45BY-SKV... ..... 638	B7RMP-G..... ..... 574	BBV-LV ..... 534	BFS... ..... 213
B45BY-TB... ..... 638	B7RMP-R..... ..... 574	BBV-SR ..... 533	BFVL... ..... 549
B45CC-R... ..... 639	B7RMP-R..... ..... 574	BBV-ST ..... 534	BFVL...E ..... 549
B45CC-R100150 ..... 639	B7RWWW-G.....P ..... 607	BBV-TW ..... 538	BFVW... ..... 549
B5101E-CC-A ..... 633	B7RWWW-G.....U ..... 612	BBV-VT ..... 534	BFW... ..... 218
B5101E-CC-B ..... 633	B7RWWW-R.....P ..... 607	BBV-DTW ..... 538	BFW... ..... 218
B5101E-CC-C ..... 634	B7RWWW-R.....U ..... 612	BBV-LV ..... 534	BGB... ..... 67, 68
B5101-RKE... ..... 634	B7W-G...P ..... 607	BBV-SR ..... 533	BGB... ..... 67, 68
B5101-RKS... ..... 634	B7W-G...U ..... 612	BBV-ST ..... 534	BGE... ..... 373
B5101-RKV... ..... 634	B7W-R...P ..... 607	BBV-TW ..... 538	BGE6 ..... 373
B5101S-CC-A ..... 633	B7W-R...U ..... 612	BBV-VT ..... 534	BGF... ..... 67
B5101S-CC-B ..... 633	B7W-R...P ..... 607	BBV100 ..... 532	BGH... ..... 235
B5101S-CC-C ..... 634	B7W-R...U ..... 612	BBV75FP ..... 532	BGHF... ..... 235
B5101V-CC-A ..... 633	B7WWW-G...P ..... 607	BC... ..... 234	BGHM... ..... 235
B5101V-CC-B ..... 633	B7WWW-G...U ..... 612	BC... ..... 135	BGV... ..... 547
B5101V-CC-C ..... 634	B7WWW-R...P ..... 607	BC-EZ ..... 137	BGV... ..... 547
B5102E-A ..... 635	B7WWW-R...U ..... 612	BC61... ..... 9	BH... ..... 147
B5102-RKE... ..... 635	B9MP-G... ..... 575	BC62... ..... 9	BH-EZ ..... 148
B5102-RKS... ..... 635	B9MP-R... ..... 575	BCC... ..... 576	BH6 ..... 165
B5102-RKV... ..... 635	B9WWW-G...P ..... 609	BCF... ..... 234	BHSC152 ..... 165
B5102S-A ..... 635	B9WWW-R...P ..... 609	BCM... ..... 234	BHSC175 ..... 165
B5102V-A ..... 635	BA... ..... 239	BCN... ..... 662	BHSC34 ..... 165
B5107-RKE800 ..... 634	BA... ..... 240, 241	BCN... ..... 662	BHT... ..... 669
B5115-RKS... ..... 636	BA-F-F ..... 657	BCP... ..... 9	BIA250... ..... 818
B5115S-BB-C ..... 636	BA31... ..... 9	BCV... ..... 558	BIB250... ..... 818
B5115S-CC-C ..... 636	BA32... ..... 9	BCW... ..... 610	BIC150 ..... 819
B5416MP-A... ..... 617	BA61... ..... 9	BD ..... 75	BID250... ..... 818
B5416MP-A100150 ..... 617	BA62... ..... 9	BD... ..... 140	BIDC250 ..... 819
B54BMP-GL... ..... 618	BA776 ..... 239	BD-EZ ..... 141	BIDP250 ..... 819
B54BMP-LX... ..... 618	BA97... ..... 241	BDS... ..... 523	BIE150 ..... 819
B54BMPLX-R... ..... 618	BAC... ..... 9	BEC... ..... 699	BIF250... ..... 818
B54BMP-R... ..... 617	BAS97... ..... 241	BF... ..... 212	BIT-KIT ..... 865
B54BMP-R...X ..... 617	BB... ..... 75	BF... ..... 212, 218	BL... ..... 845
B54BMP-SK... ..... 617	BB... ..... 68	BF... ..... 218	BL-NS ..... 845
B54BMPS-R... ..... 618	BB... ..... 133	BF-SS ..... 212	BLCA152CS ..... 172
B54BMP-VK... ..... 618	BB-EZ ..... 133	BF30-... ..... 622	BL-RK... ..... 845
B54G-P... ..... 617	BB3-0-AG ..... 378	BF302-... ..... 622	BL-RK... ..... 845
B6-1 ..... 71	BB3-0-AGMB ..... 378	BFC... ..... 550	BL-RK... ..... 845
B72G-AG ..... 415	BB3-0-MG ..... 378	BFC... ..... 550	BLS... ..... 202
B72G-AG-MB ..... 415	BB3-0-MGMB ..... 378	BFL... ..... 218	BLS... ..... 202, 237
B72G-MG ..... 415	BBFVW... ..... 549	BFM...B ..... 218	BLS-NST ..... 203
B72G-MG-MB ..... 415	BBFVW...E ..... 549	BFMW... ..... 218	BLS-NST ..... 203
B73G-AG ..... 416	BBLV... ..... 365, 533	BFN... ..... 752, 854	BLS8-8 ..... 202
B73G-AG-MB ..... 416	BBLV... ..... 533	BFN-NST ..... 750, 752, 854	BLT... ..... 701
B73G-MG ..... 416	BBU... ..... 75	BFN75 ..... 752, 854	BM... ..... 210
B73G-MG-MB ..... 416	BBU... ..... 75	BFN75GHT ..... 752, 854	BM... ..... 210
B74G-AG-MB ..... 416	BBV... ..... 532	BFNE150 ..... 752, 855	BM... ..... 210

Index Part Number

	Page #		Page #		Page #		Page #
BMA...	241	BS..N	199	BWSG	858	CB	68
BMAS...	857	BS61-...	9	BWSG-TI	860	CB6-AG	391
BMS	73	BS62-...	9	BWSG-W	858	CB6-AGMB	391
BMS..	73	BS8-8	201	BZ4051	46	CB6-MG	391
BMV..	533	BS818	234	BZ4051S	46	CB6-MGMB	391
BMV100	533	BSA..	857			CBB...	198
BN	754, 857	BSB..	290	C..	691	CBC..	236
BN..	211, 754, 857	BSB-..	893	C...	691	CBSR...	105
BN...	211, 551	BSB...	290	C...BU	691	CC	71
BN....	551	BSB-...-	893	C..BU	691	CC....	890
BN...RU..	231	BSB-...-	893	C03-0A	380	CC....B	890
BN...RU..SS	231	BSB-..T	893	C03-0AMB	380	CCF...	288
BN..BSPT	212	BSB-..T-...	893	C03-0M	380	CCH50	885
BN..F	754, 857	BSB-20Z	893	C03-0MMB	380	CD	75
BN..NYFD	754, 857	BSC...	290	C08-02A	380	CDMHCB....	812
BN..RU..	231	BSCCQ-R...	621	C11-..A	432	CF...-CS	113, 114
BN..RU..SS	231	BSCCQ3-R...	621	C11-..M	432	CF...-SS	113, 114
BNH..	290	BSCCQ4-R...	621	C119-..A	432	CF...-CS	113, 114
BNH...	290	BSCCS-R...	621	C119-..AMB	432	CF...-SS	113, 114
BNS..	857	BSM..	663	C119-..M	432	CF400-..CSHD	118
BNS..SS	857	BSO150-H	754	C119-..MMB	432	CF400-CSHD	118
BNT...F	754	BSO150NST	754	C16-..A	395	CFB...S	759
BOC-T..	896	BSO150S	754	C16-..AMB	395	CFB...NST	759
BP...-	680	BSS61-...	9	C16-..M	395	CFB...S	759
BP...-T...	680	BSS62-...	9	C16-..MMB	395	CFB75GHT	759
BPF..	224	BST	190	C18-..A	396	CFFR150	760
BPF...	224, 551	BST..	190	C18-..AMB	396	CFFR150NST	760
BPFS..	225	BSVD-HC...B...	642	C18-..M	396	CFG...NST	759
BPM	225	BSVS-HC...B...	642	C18-..MMB	396	CFG...S	759
BPM..	225	BTB-T..	896	C2	272	CFR..	747
BPN..	223	BTB-T..Z	896	C26-..A	396	CFR47-1-...	747
BPN...	223	BTN75	754, 862	C26-..AMB	396	CFR47-150-...	747
BR...	654, 887	BU	75	C26-..M	396	CFR47-C	747
BR...B	655	BU..	75, 76	C26-..MMB	396	CFS800-CS	79, 117
BR...FS	655	BV2	554	C28-..A	397	CG...	270
BR...G	654	BV2CV...CC-A	631	C28-..AMB	397	CGN...NST	756
BR...SS	655	BV2GG...CC-A	632	C28-..M	397	CGSN...F	756
BR1BF-B-E-7	325	BV2IC...VW-A	542	C28-..MMB	397	CGSN...S	756
BR1F-B-E-7	325	BV2IGN...11-A	541	C31-..A	397	CH-B	172
BR1GM-B-E-7	325	BV2IGN...33-A	541	C31-..AMB	397	CH-B..	172
BR1M-B-E-7	325	BVDSO...	762	C31-..M	397	CH-C..	172
BR1S...B-E-7	325	BVDSO...NST	762	C31-..MMB	397	CH-SS..	172
BRN150	753	BVFS..	560	C31-08FRAME	399	CI9	904
BRN150NST	753	BVSO...	762	C33112	882	CI9311SML	904
BRN150NST-I	753	BVSO...NST	762	CAB...	198	CI96	904
BRN150S-I	753	BVSO150-125	762	CAB...N	199	CI96AH	904
BS..	76	BVSO150NST-125	762	CAL..	173	CILR...	105
BS...	199, 201	BVTSO150	762	CAMOPENER	127, 910	CILR...OCS	104
BS...-	622	BVTSO150-200	762	CAP...F-C	788	CJ-BF-B	320
BS...-	622	BVTSO150NST	762	CAP...F-C-LH	788	CJ-BM-B	320
BS...-	622	BVTSO150NST-200	762	CAP...S-C	788		

Part Number Index

Part Number Index

Page #	Page #	Page #	Page #
CJ•BM•-LG ..... 320	CSN75 ..... 862	D2B2-B ..... 315	DC•• ..... 302, 309, 310
CJ•F•-B ..... 320	CSS••••CS ..... 196	D2C•••• ..... 8	DC••• ..... 307
CJ•M•-B ..... 320	CSS••••CS ..... 196	D2F•-B ..... 311	DC•••• ..... 302, 303, 309
CJ•M•-LG ..... 320	CSSR•••-3A ..... 105	D2S•-B ..... 312	DC••••L ..... 302, 309
CJ2BF•-LG ..... 320	CSSR•••CS ..... 104	D34•• ..... 366	DC••••LSE ..... 304
CJ2F•-LG ..... 320	CSSR250 ..... 105	D-4HF4-S-FNS ..... 453	DC••••SE ..... 304
CJ2M2-B ..... 374	CSSTF••F•T• ..... 813	D-4HF4-S-FSB ..... 453	DC••L ..... 307
CJ3BF• ..... 320	CSSTM25F30T• ..... 813	D-4HF4-SS-FNS ..... 453	DC••S ..... 312, 313
CJ3BM• ..... 320	CT••L ..... 266	D-4HF4-SS-FSB ..... 453	DC••SE ..... 304
CJ3F• ..... 320	CTER••• ..... 105	D605 ..... 373	DC•SE ..... 304
CJ3M• ..... 320	CV••• ..... 559	D75AL ..... 562	DC1045S ..... 314
CL•••• ..... 886	CVS•• ..... 172	D8••Y100RAF ..... 734	DC2••S ..... 314
CL••••• ..... 886	CVV••BF•• ..... 496	D8••Y50RAF ..... 734	DC9S ..... 313
CM•F• ..... 502	CVV••DC ..... 497	D815100•• ..... 734	DCB•• ..... 312, 313
CM•F•-B ..... 502	CVV••F•• ..... 496	D815-25•• ..... 734	DCB••• ..... 313
CM•M•-B ..... 502	CVV•BF• ..... 496	D815-50•• ..... 734	DCB•••• ..... 312-314
CM•M•-B-L• ..... 502	CVV•DC ..... 497	D815Y100RAS ..... 734	DCL•• ..... 908
CM•M•-B-L•• ..... 502	CVV•F• ..... 496	D815Y50RAS ..... 734	DCM1 ..... 909
CM3M2-B-L11.5 ..... 502	CVV•FM•••• ..... 496	D817Y50RAF ..... 734	DCP• ..... 306
CMF•• ..... 448	CVV•OF• ..... 496	D825100•• ..... 734	DCP•• ..... 300, 308, 310, 320
CN ..... 22	CWG-C-••••• ..... 900	D825-25•• ..... 734	DCP••• ..... 306, 311, 316
CN••• ..... 662	CWG-S-••••• ..... 900	D825-50•• ..... 734	DCP•••• ..... 300, 301, 308, 312, 318
CN•••B ..... 661	CWH50 ..... 883	D8325Y50RAF ..... 734	DCP••••L ..... 301, 308, 315
CN•••G ..... 662	D•• ..... 365, 554, 562	DAA•••AL ..... 16	DCP•••L ..... 306
CN•••SS ..... 662	D••• ..... 376	DAA•••ALFL ..... 16	DCP••S ..... 311
CNB75GHT ..... 765, 863	D•••• ..... 740	DAB• ..... 849	DCP••SWIV ..... 301
CNB75GHT-GD ..... 765, 863	D•••••F ..... 740	DAB•• ..... 849	DCP2023B ..... 311
CN-P ..... 22	D•••R ..... 447	DAC•••• ..... 849	DCP20B ..... 311
CN-PLUG ..... 22	D••S ..... 447	DAC•••AL ..... 15	DCP210•B ..... 311
CPV••F ..... 839	D••U ..... 447	DAC•••ALBSP ..... 15	DCP214•• ..... 312
CR ..... 275	D••SC ..... 562	DADC250 ..... 16	DCS• ..... 313
CR-C ..... 22	D•B• ..... 315	DADP250 ..... 15	DCS•• ..... 312, 313
CR-CAP ..... 22	D•BF• ..... 311	DATL•• ..... 367	DCS••• ..... 314
CR-S ..... 22	D•BM• ..... 311	DATL••W ..... 367	DCS••••F ..... 809
CRWC ..... 275	D•F• ..... 311	DAWS•• ..... 849	DCS••••F•• ..... 809
CS•• ..... 270	D•M• ..... 311	DB• ..... 72	DCS4025F•- ..... 809
CS••••AL ..... 111, 112	D•M•-B ..... 311	DB•• ..... 72	DCS4030NYFD ..... 809
CS••••CS ..... 111, 112	D150SDB ..... 859	DBA•••• ..... 7	DD ..... 75
CS••••SS ..... 111, 112	D150S-WAND ..... 859	DBAF•••• ..... 7	DDA••••105 ..... 12
CS••••AL ..... 111, 112	D18-04M ..... 398	DBAF••••• ..... 7	DDA••••105FL ..... 12
CS••••CS ..... 111, 112, 196	D18-04MMB ..... 398	DBAV73-2030 ..... 8	DDA••AL ..... 12
CS••••SS ..... 111, 112	D2•• ..... 315	DBC•••• ..... 6	DDA••AL••TTMA ..... 12
CSB•• ..... 199	D201 ..... 373	DBC••••-GL ..... 6	DDA••ALFL ..... 12
CSC-T••-1 ..... 897	D201RT ..... 372	DBCL••• ..... 6	DDA••BR ..... 12
CSC-T••-2 ..... 897	D204-30 ..... 371	DBGV•• ..... 547	DDA••BRFL ..... 12
CSCTF25F30T• ..... 814	D204-30P ..... 371	DBGV••• ..... 547	DDA••SS ..... 12
CSCTM25F30T• ..... 814	D204-30SB ..... 371	DBS•••• ..... 6	DDA••SSFL ..... 12
CSES150F ..... 803	D263 ..... 740	DBV-BL•• ..... 695	DDC••••105 ..... 11
CSES150T ..... 803	D263F ..... 740	DBV-BN•• ..... 695	DDC••AL ..... 11
CSES2015F ..... 803	D28••MMB ..... 398	DBV-WB•• ..... 695	DDC••BR ..... 11
CSM•• ..... 199		DC• ..... 302, 307	

	Page #		Page #		Page #		Page #
DDC•••SS	11	D-H4F4-S	453	DMR••F•S	784	E74•A-MB	421
DDC•••SSFL	11	D-H4F4-SS	453	DMR••F•T	784	E74•M	421
DDC400AL164TTMA	11	D-H4F4-SV-8	453	DMR••S•T	784	E74•M-MB	421
DDDC•••	12	DHS•••••	899	DMXL••	209	EA•F•	501
DDDC300105	12	DHS159-1•••	899	DN•	710	EC•••	699
DDDP•••	11	DHS90•••	899	DN••	710	EK602•	433
DDDP300105	11	DIN-SMS-60/90SP	586	DN7•OBF	852	EK602VB	433
DDSA•••SS	13	DIN-SMS90/155SP	586	DN7U•BF-NC	852	EL•••••	259
DDSC•••SS	13	DKC1	301	DN7U•BF-NPNF	852	EL••••••	255, 259
DDT1	909	DL••	279, 527	DNOG•	853	EL••H•M	214
DEFN075	853	DL•••	279	DNOG5-NL	853	EL•F•F	664
DF16•••	801	DL••••	265	DP2-01•••	402	EL•H•M	214
DFC•	710	DLB12	77	DPW	561	EL•H•MSS	214
DFC••	710	DLS••••	265	DRC•	710	EL45••	667
DFG•	376	DM•	209	DRC••	710	EL45•••	667
DFN•••	851	DM••	209	DRK15	909	EL90••	664
DFN100•-NC	850	DM•••	209	DRP-85-059	401	EL90•••	664
DFN100•-NPNF	850	DM•••••RAF	877	DSB••	207	EL90•••B	664
DFN100•F	850	DM•••••RAS	877	DSBV••	539	EL90•••FS	664
DFN100F-NC	852	DM•••••RAT	877	DSBV•••	539	EL90•••G	664
DFN100F-NPNF	852	DM•••••UC	877	DSCV••	560	EL90•••SS	664
DFN100-NC	851	DM•••••RAF	877	DSCV•••	560	EL90••FS	664
DFN100-NPNF	851	DM•••••RAS	877	DSK••	908	EL90••G	664
DFP••••	768	DM•••••RAT	877	DST••	207	EL90••SS	664
DFP••••F	768	DM•••••UC	877	DSTW	910	ENBG1	372
DFP••••F-D	768	DM••100GAX	877	DTW•••	741	ENBL	22
DFP••F•S	768	DM••50GAX	877	DWG050	860	ENBL-P	22, 26
DFP••NYFD•NYFD	768	DM150SDB	859	DWL100	910	ENBL-P•	26
DFR••••	768	DMH••••	782	DX••••	747	ENBL-PLUG	22
DFR••••F	768	DMH•••••D	784	DXHDR25HC	745	ER••••	741
DFVS••	208	DMH•••••F	782	DXHDR25PB	745	ER•••••	741
DG•••	444	DMH•••••F-D	784	DXHDC25HC	745	ERJ	22
DG••••	444	DMH•••••NYFD	783	E••F••	499	ERJ-C	22
DG•••••	444	DMH••F•F	782	E••F••-B	499	ERS	22
DGA•••SS	14	DMH••F•F-D	784	E••F••-S	499	ERS-C	22, 26
DGA•••SS••	14	DMH••F•S	782	E••F••-S	499	ERS-C•	26
DGA•••SSFL	14	DMH••F•S-D	784	E••M••	499	ERS-CAP	22
DGC•••SS	14	DMH••NYFD•NYFD	783	E••M••-B	499	ETP	905
DGDC•••	14	DMH••S•S	782	E•BF•-B	499	EZL••0-B••	126
DGDP•••	14	DMH••T•S	782	E•F•	499	EZL••0-C••	126
DGH7	243	DMH••T•T	782	E•F•-B	499	EZL••0-D••	126
DGH7C	243	DMH20DR20	562	E•F•-S	499	EZL••0-DC••	127
DGH7CSS	243	DMH25F25NYFD	783	E•M•	499	EZL••0-G••	127
DGH7CV	243	DMOCA••225F	816	E•M•-B	499	EZL•00RPLKIT	127
DGH7P	243	DMP••••	784	E•M•-S	499	EZLCL400	127
DGH7PSS	243	DMP•••••F	784	E•S•	500	F•	267, 271
DGH7SS	243	DMP••F•S	784	E•S•-B	500	F••	267, 271
DGH7V	243	DMP••F•T	784	E73••-MB	421	F•••	267, 271
DGHW7	243	DMP••S•T	784	E73••A	421	F••••	91
DGLBV••	548	DMR••••	784	E73••M	421	F•••••	91
DGLBV•••	548	DMR•••••F	784	E74••A	421		

Part Number Index

Index Part Number

Page #	Page #	Page #	Page #
F••E-SKIT ..... 500	F602••WJR ..... 428	FFC••• ..... 552	FLC2501-•••• ..... 721
F••G-•••• ..... 106	F72G-•A ..... 408	FFH••••F ..... 766	FLC2603-•• ..... 722
F••H-SKIT ..... 455	F72G-•A-MB ..... 408	FFH••••NYFD ..... 766	FLG•••E ..... 697
F••V-SKIT ..... 470	F72G-•M ..... 408	FFH••F••F ..... 766	FM••• ..... 684
F-•E-SKIT ..... 500	F72G-•M-MB ..... 408	FFH••T••S ..... 766	FM•••• ..... 684, 775
F-•H-SKIT ..... 455	F73G-•A ..... 409	FFH15NYFD15NYFD ..... 766	FM••••F ..... 775, 776
F-•V-SKIT ..... 470	F73G-•A-MB ..... 409	FFN••• ..... 763	FM••••F-D ..... 774
F03-0•A ..... 377	F73G-•M ..... 409	FFN•••NST ..... 763	FM••••NYC ..... 776
F03-0•AMB ..... 377	F73G-•M-MB ..... 409	FFN75GHT ..... 763	FM••••NYFD ..... 776
F03-0•M ..... 377	F74C-•A-MB ..... 410	FFS••• ..... 552	FM••••T ..... 775, 776
F03-0•MMB ..... 377	F74G-•A ..... 409	FGH•• ..... 883	FM••F••F ..... 775, 776
F07-•••A ..... 407	F74G-•A-MB ..... 409	FHCS150 ..... 801	FM••F••F-D ..... 774
F07-•••M ..... 407	F74G-•M ..... 409	FHHR-• ..... 748	FM••F••NYC ..... 776
F07-200•C ..... 406	F74G-•M-MB ..... 409	FHHR-C ..... 748	FM••F••NYFD ..... 776
F08-0•M ..... 377	F74H-•A-MB ..... 410	FHHR-C• ..... 748	FM••F••S ..... 775, 776
F08-0•MMB ..... 377	F74V-•A-MB ..... 411	FHPR150 ..... 749	FM••F••S-D ..... 774
F08-02A ..... 377	FA•• ..... 697	FHPR150••CBF ..... 749	FM••F••T ..... 775, 776
F08-02AMB ..... 377	FAB••• ..... 198	FHPR150-100CBF ..... 749	FM••F••T-D ..... 774
F16-••A ..... 381	FAB•••N ..... 199	FHPR2515 ..... 749	FM••NYFD••F ..... 776
F16-••AMB ..... 381	FAPRAV250F ..... 837	FHR-C ..... 744	FM••NYFD••T ..... 776
F16-••M ..... 381	FAPRAVF250 ..... 837	FHR-C1 ..... 744	FM••S•• ..... 775
F16-••MMB ..... 381	FAPRAVG250• ..... 837	FHR-V• ..... 744	FM••S••F ..... 775, 776
F17-•••A ..... 410	FAPRV•250 ..... 837	FJB-•••• ..... 894	FM••S••F-D ..... 774
F17-•••M ..... 410	FBB••• ..... 198	FJB-20Z-20 ..... 894	FM••S••T ..... 776
F18-••A ..... 381	FBSO100• ..... 763	FJC-•••• ..... 894	FM••S••T-D ..... 774
F18-••AMB ..... 381	FBSO100•-PG ..... 763	FJC-20Z-20 ..... 894	FM25NYC25F ..... 776
F18-••M ..... 381	FBSO150• ..... 763	FJC45-•••• ..... 895	FM25NYC25T ..... 776
F18-••MMB ..... 381	FBSO150•-PG ..... 763	FJC45-20Z-20 ..... 895	FMB••• ..... 684
F18-C00• ..... 410	FBV•• ..... 535	FJC90-•••• ..... 895	FMB•••• ..... 684
F23-04M ..... 399	FBV••• ..... 535	FJC90-20Z-20 ..... 895	FMBTFLY••F••F ..... 842
F26-••A ..... 381	FBV•••SE ..... 536	FJC-T•• ..... 896	FMBV••F••F ..... 832
F26-••AMB ..... 381	FBV••SE ..... 536	FJR-T•• ..... 896	FMBV••S••S ..... 832
F26-••M ..... 381	FBVG•• ..... 536	FJS-•••• ..... 894	FMF••• ..... 517
F26-••MMB ..... 381	FBVG••• ..... 536	FJS-20Z-20 ..... 894	FMF•••• ..... 517
F28-••A ..... 382	FBVL•• ..... 535	FJS45-•••• ..... 895	FMF••••-45 ..... 517
F28-••AMB ..... 382	FBVL••• ..... 535	FJS45-20Z-20 ..... 895	FMF••••-90 ..... 517
F28-••M ..... 382	FC••• ..... 787	FJS90-•••• ..... 895	FMF••••-45 ..... 517
F28-••MMB ..... 382	FC•••• ..... 257, 259	FJS90-20Z-20 ..... 895	FMF••••-90 ..... 517
F30-••A ..... 382	FC••••• ..... 253, 259	FL•••• ..... 91	FMGR••F••F ..... 841
F30-••AMB ..... 382	FC•••••ST•• ..... 253	FL••••• ..... 91	FMI••••• ..... 260
F30-••M ..... 382	FC•••••ST•• ..... 258	FLBV•••CS ..... 545	FMI•••••• ..... 260
F30-••MMB ..... 382	FC•••F ..... 787	FLC0318-•• ..... 722	FMI••••••• ..... 260
F35-0•AMB ..... 382	FC•••F-• ..... 787	FLC0319-•• ..... 722	FMR••• ..... 684
F35-0•MMB ..... 382	FC•••F-D ..... 790	FLC2402-•••• ..... 720	FMR•••• ..... 684
F-4EA-SKIT ..... 501	FCB48 ..... 750	FLC2403-•• ..... 721	FMR••••• ..... 260
F-4N-SKIT ..... 295	FCM•••• ..... 257	FLC2404-•• ..... 720	FMR•••••• ..... 260
F602-••4A ..... 428	FCSB••• ..... 199	FLC2404-•••• ..... 720	FMR••••••• ..... 260
F602-••8A ..... 428	FCSM••• ..... 199	FLC2405-•• ..... 721	FMS••• ..... 684
F602-••BJ ..... 428	FD47-C2 ..... 746	FLC2405-•••• ..... 721	FMS•••• ..... 684
F602-••BJR ..... 428	FD47IR-150-100 ..... 746	FLC2500-•• ..... 722	FN•••NST ..... 753, 855
F602-••WJ ..... 428	FFB••• ..... 552	FLC2501-•• ..... 721	FN•••S ..... 753, 855

	Page #		Page #		Page #		Page #
FN600	19	FRS-C	19	FT••B	668	G•••DD••	180
FN600B	19	FRSGX••	898	FT••FS	668	G•••DP••	179
FN600BL	19	FRSGX110	898	FT••G	668	G•••E	700
FN600BL-NI	20	FRT••••	669	FT••SS	668	G•••E••	178
FN600B-PLUG	19	FRX	20	FT590•G	32	G•••E••CR	110
FN600S	21	FRX-C	20	FT590•GT	32	G•••F••	178
FNB•••NST	753, 855	FRXCAP	20	FT6••	31	G•••F-ALNST	183, 786
FNB•••S	753, 855	FS•	267	FT6••••	31	G•••HRP	182
FNB75GHT	753, 855	FS••	267	FT600	31	G•••HRPSI	182
FNB75GHT-GD	765, 863	FS•••	267	FT600•	31	G•••HRPSS	182
FNB75S	753, 855	FS2403•	506	FT600S-4	31	G•••N	695, 700
FNBE150NST	758, 856	FS2403••	506	FT600SC	31	G•••T	695, 700
FNBE150S	758, 856	FS2404•••	506	FT620•	31	G•••V	700
FNG•••NST	758, 856	FS2404••••	506	FTH100	751	G•••VB	695
FNG•••S	758, 856	FS2408•	507	FVFA••	208	G•••A••	174
FNPSO150•••	764	FS2408••	507	FVL••	208	G•••B••	175
FNS	21	FS2501•••	507	FVS••	208	G•••C••	176
FNS2	21	FS2501••••	507	FVSP••	208	G•••D••	177
FNSID	21	FS2603•	507	FWV••F••F	830	G•••DC••	179
FO•	267	FS2603••	507	FWV••S••S	830	G•••DP••	179
FO••	267	FS304C•	507	FX1500	20	G•••E••	178
FO•••	267	FS304C••	507	FX1500P	20	G•••F••	178
FOS•	267	FS6400•••	506	FX1500PLUG	20	G•••HRP	182
FOS••	267	FS6400••••	506	FX1500S	20	G•••HRPSI	182
FOS•••	267	FS6500•••	506	FX1500SP	20	G••00-AL-AL	182
FP•••	792	FS6500••••	506			G••00-DL-AL	182
FP••••	261	FS6602•	507	G•••••HRPSS	182	G10	59
FP•••••	255, 261	FS6602••	507	G•••••00	703	G3050	45
FP•••F	792	FS6801•••	506	G•••••A••	181	G400•LT-AL	181
FP•••F••	792	FS6801••••	506	G•••••AA••	180	G5•••	95
FP•••F-D	792	FSA••••F	793	G•••••C••	181	G75HRPSS	182
FP475S	757	FSA••••S	793	G•••••DA••	180	G9	59
FP500•	757	FSA••••T	793	G•••••E	700	GAM•	285
FR3C••••	807	FSB	21	G•••••E••	181	GAM••	285, 286
FR3C6025F	807	FSCV••	559	G•••••T	700	GAS••••NO	143, 194
FRA	19	FSCV•••	559	G•••••V	700	GAS••••NOS	144, 195
FRA-C	19	FSGLBV••	548	G•••••A••	174	GAS••••TO	92
FRA-NI-C	20	FSGLBV•••	548	G•••••AA••	180	GAW	800
FRC4025	805	FSGR•••F	841	G•••••A-ALNST	183, 786	GB•	67, 68
FRC4025F	805	FSGV••	547	G•••••B••	175	GB••	67, 68, 110
FRC6025	805	FSGV•••	547	G•••••B••••	175	GB6-1	67
FRC6025F	805	FSGV••••F	829	G•••••B-ALNST	183, 786	GBA••	77
FR-CAP	19	FST••	193	G•••••BL	695	GBB••	77
FRP-95•••	370, 401, 402	FST•••	193	G•••••C••	176	GBR••	437
FRP-96•••	401	FST••CS	116	G•••••C••••	176	GBR•••	437
FRRE-T••	897	FSW•	801	G•••••C••CR	109	GBR••••	437
FR-RS	19	FT••	668	G•••••D••	177	GBRW••	443
FR-RS-C	19	FT•••	668	G•••••D••••	177	GBRW•••	443
FR-RS-R	19	FT•••FS	668	G•••••D-ALNST	183, 786	GBRW••••	443
FRR-T••	897	FT•••G	668	G•••••DC••	179	GBRW30R	443
FRS	19	FT•••SS	668	G•••••DC••••	179	GC•	67



Part Number Index

Index Part Number

Page #	Page #	Page #	Page #
GC...	435, 440	GM•	69
GDB•	69	GM••	69, 365
GDB••	69	GMAS•	70
GDF•	77	GMAS••	70
GDF••	77	GNB75GHT	765, 863
GDL•	77	GPA-95-...	403-405
GDL••	77	GPA-95-292	906
GF•	67	GPA-96-...	404, 405
GF••	67	GPA-97-...	405
GF•••	67	GROOVLUB32	701
GF•••P•	69	GRP-95-...	401-403, 405
GF••P•	69	GRP-96-...	401-403, 405
GF26-1	67	GS••••-4	435
GFAS•	70	GS•••-4	435
GFAS••	70	GS••-4	435
GFN150	762	GSAFETYCLIP	182
GFN150NST	762	GSS••	436
GFR•	21	GSS•••	436
GFR••	21	GSS••••	436
GFR1•	21	GSS•••••	436
GFR1••	21	GSS•••••-4	436
GH••••	74	GSS•••••-4	436
GHC7	242	GSS•••-4	436
GHGN	245	GSS•••-4	436
GHN75	760	GSTC•	192
GHN75-B	760	GSTC••	192
GHV	244	GW DGV250F	825
GHY	244	GWH••••	912
GHYV	244	GWH•••••	912
GIBFV••	699	GWH1•00R	912
GJ••	77	GWHC	912
GL••	365, 435, 440	GWHC-C	912
GL•••FG	438	GWHC-FF	912
GLBR••	443	GWHZ••	913
GLBR•••	443	GWHZ•••R	913
GLBR••••	443	H••	690
GLBR••••-4	443	H•••	100, 690
GLBR•••-4	443	H••••-BU	99
GLBR••-4	443	H••••BU	690
GLBR100004	443	H••••Y50SZ	738
GLBRC••	443	H••••Y50UC	738
GLBRC•••	443	H••BF••	452
GLBRC••••	443	H••BF•••B	452
GLP••	441	H••BF•••S	452
GLS••	441	H••BF•••SS	452
GLSC••	441	H••BU	690
GLSS••	442	H••DC-A	454
GLSS•••	442	H••F••	452
GLSS••••	442	H••F•••B	452
GLSS•••••	442	H••F•••S	452
GLSSC••	442	H••F•••SS	452
		H••F•••SS	452
		H••BF••	451
		H••BF•••B	451
		H••BF•••S	451
		H••BF•••SS	451
		H••DC-A	454
		H••F••	451
		H••F•••B	451
		H••F•••BOP	457
		H••F•••S	451
		H••F•••SS	451
		H••F•••SS-BOP	457
		H••M••	451
		H••M•••S	451
		H••OF••	451
		H1DC	454, 482
		H4F4-HV	453
		H5••	95
		H5••••-BU	95
		H5••••NST	95
		H5•••R100UC	736
		H5•••R50UC	736
		H515R100••	736
		H515R50••	736
		H52••-A	95, 97
		H52••-A-BU	95, 97
		H52••-L-A	97
		H52••-L-A-BU	97
		H525R100••	736
		H525R50••	736
		H610Y50••	738
		H615Y50••	738
		H625Y50••	738
		HA••••	771
		HA•••••ADP	785
		HA•••••-D	773
		HA•••••F	771
		HA•••••F-D	773
		HA•••••T	771
		HA•••••T-D	773
		HA•••NYFD••F	773
		HA•••NYFD••S	773
		HA•••NYFD76	773
		HA••S••	771
		HA••S•••F	771
		HA••S•••S	771
		HA••S•••T	771
		HA••T••F	771
		HA••T••S	771
		HA023•	106
		HA024•	106
		HA0900••	683
		HA2515F	750
		HA25NYC76	773
		HA25NYFD15NYFD	773
		HAB•••EZ	151
		HAC•••EZ	151
		HAD•••EZ	151
		HB•••	246
		HB••••	365, 658
		HB•••••B	658
		HB•••••FS	658
		HB•••••G	365, 658
		HB•••••SS	658
		HB••F••M	659
		HBC••S	269
		HBC••S	269
		HC30143	750
		HC90	892
		HC90RB	892
		HD1••	528
		HDBF75	561
		HDPE•••	702
		HDPE••••BU	702
		HDSSF75	561
		HFN••	752, 854
		HFN••••NST	752, 854
		HFN150NYFD	752, 854
		HFN••P•	26
		HFR••C•	26
		HGB••••NST	753, 855
		HGB100S	753, 855
		HGCFB••••NST	759
		HGCFB150S	759
		HGG100NST	758, 856
		HGG100S	758, 856
		HGV250	827
		HGV250F	827
		HGV250F-D	827
		HGV250-H	827
		HGV-HDWHL	828
		HGV-KNOB	828
		HGVW250F	828
		HGVW250-W	828
		HHA••••	773
		HHCI	230
		HHD••P	530
		HHD••T	530
		HHP••M	672
		HHTP	905
		HN	23
		HN••••SS	662

	Page #		Page #		Page #		Page #
HN•SS	662	HSTBC••••	277	HUC20•00BC	81	IXAN••	102
HN•M•M	662	HT•BF••	474	HUF•••••CS	78	IXF•••	94
HNBGH••	235	HT•F••	474	HUF206200MT	83	IXFDPLG•••	101
HNBGHF••	235	HT•OF••	474	HUF206400FLG	82	IXFS••	102
HN-P	23	HT•BF•	474	HUF206400FLG-45	82	IXFS32-3A	102
HN-PLUG	23	HT•BF••	474	HUF206400FLG-ST	82	IXH••	93
HP•	266	HT•BF••-SS	474	HUFALL•••CS	78	IXM••	93
HPBV••	544	HT•BF••-SS	474	HUFALL•00FLG	82	IXMS••	102
HPBV•••	544	HT•DC	475	HUM•••••CS	79	IXPE32-3A	101
HPBV••SAE	544	HT•F•	474	HUM206•00FLG	82	IXSE••	101
HPBV••-3WAY	544	HT•F••	474	HUM206400FLG	82	IXSE••-3A	101
HPBV••SAE	544	HT•F••-SS	474	HUM206400FLG-45	82	IXV••	94
HPBV••SS	544	HT•F••-SS	474	HUM206400FLG-ST	82		
HPFN150	752, 854	HT•JB•	475	HUMF•••••CS	78	J••	279, 527
HPFN150NST	752, 854	HT•M•	474	HUMF206400••	83	J•••	171
HPSG	865	HT•OF•	474	HUP207400	81	J•B•	317
HPSGHD	865	HT•OF••	474	HUP207400DC	81	J•F•	316
HPSGL	865	HT•OM•	474	HUPALL•00	81	J•M•	316
HPSGW	865	HT•RB•	475	HUS500RN	79, 80	J•S•	316
HR	23	HTBC•••	277	HUSF500SW	79	J2F2-B	316
HR1610	748	HTBG	374	HUSM500SW-1	79	J2M2-B	316
HR1610••	748	HTBG•	374	HVF••••-25	804	J47	77
HR-C	23	HTBG••	374	HVG0•••-25	804	J844•••-100	887
HRC•••	528	HTBG••EXT	374	HWH50	884	J844••-BL-100	887
HR-CAP	23	HTBG•EXT	374	HWH50-75	884	JS••	269
HS•	263	HTBG-CT	374	HY•	528	JX••	279
HS••	263	HTE•BF•	477	HY••	528		
HS•••	263	HTE•BF••	477			K•	268
HS•••AL	848	HTE•F•	477	IA•••TP	906	K••	268
HS•••SS	848	HTE•F••	477	IB•••	133	K•••	268
HS•BF•	458	HTE•OF•	477	IBFVW•••	549	K••BF••	459
HS•BF•-B	458	HTE•OF••	477	IBFVW•••E	549	K••F••	459
HS•BF•-S	458	HTM•••	266	IBR••••	887	K•BF•	459
HS•F•	458	HTSW	799	IBV••	544	K•BF•-SS	459
HS•F•-B	458	HTW••P	529	IBV•••	544	K•F•	459
HS•F•-S	458	HTW••T	529	IBV50BOV	906	K•F•-SS	459
HSCE•••	637	HU•••••N	80	IC•••	135	K•OF•	459
HSC-RKE•••	637	HU•••••RN	80	ICL••••	886	K4•-DC	460
HSC-RKV•••	637	HU100•••	681	ID•••	140	K4DC	460
HSCV•••	637	HU100•••BW	681	ID•••TC	906	KB••	68
HSR••	745	HU1002•••	682	IH•••	147	KHN•••	197
HSR••••	745	HU1002•••BW	682	IH6	165	KLW•	205
HSRC••	744, 745	HU1502•••	683	IHC•••F	790	KLW••	205
HSRC••••	745	HU1502•••BW	683	IHSC152	165	KM••	210
HSS•	263	HU200•••	681	IHSC34	165	KM•••	210
HSS••	263	HU200•••BW	681	IRC4025	805	KNW•	205
HSS•••	263	HU206•••	681	IRC4025F	805	KNW••	205
HST••	190	HU400•••	682	IRC4025GF	805	KRH••	884
HST••P	529	HU602•••	682	IRCS4025F	808	KRH•••	884
HST••T	529	HU602•••BW	682	ITD••	894, 895	KRN•••	197
HSTBC•••	277	HUC20•00	81	ITDH	894, 895	KRN••••	197

Part Number Index

Index Part Number

Page #	Page #	Page #	Page #
KRW• ..... 205, 754, 857	L606-••4B ..... 431	LW••200 ..... 899	MC••••ST•• ..... 254
KRW•• ..... 205, 754, 857	L606-••B ..... 431	LWSG-• ..... 858	MC•••ST•• ..... 258
KRW•••• ..... 205	L606-••W ..... 431	M• ..... 74	MCH50 ..... 885
KS• ..... 268	L72M-• ..... 417	M•• ..... 74	MCM•••• ..... 257
KS•• ..... 268	L72M-•MB ..... 417	M•••• ..... 256	MCM••••XL ..... 260
KS••• ..... 268	L73M-• ..... 417	M••••RAF ..... 875	MCS•• ..... 199
KSS•• ..... 364	L73M-•MB ..... 417	M••••RAS ..... 875	MD••••T ..... 740
KSV10-••• ..... 557	L74C-• ..... 420	M••••RAT ..... 875	ME•• ..... 704, 705
KSW•• ..... 364	L74C-•MB ..... 420	M••••UC ..... 874	ME•••• ..... 706
KVW•• ..... 205	L74M-• ..... 418	M••••GAX ..... 876	ME••••• ..... 704
L•• ..... 692	L74M-•MB ..... 418	M••••KAF ..... 876	ME•••••• ..... 705
L••• ..... 692, 698	L74M-•MBPX ..... 419	M••••KAS ..... 876	ME•••F-• ..... 706
L•••• ..... 698	LCJS-•• ..... 903	M••••RAF ..... 875	ME•••FS-• ..... 706
L••••A-AL ..... 128	LCJS12-15 ..... 903	M••••RAS ..... 875	ME•••S ..... 704, 705
L••••A-SS ..... 128	LCLD ..... 903	M••••RAT ..... 875	ME•••S-• ..... 706
L••••BU ..... 692	LCTS• ..... 903	M••••UC ..... 874	ME•••S•• ..... 704
L••••C-SS ..... 128	LCTS14 ..... 903	M•200 ..... 369	ME109-NH3-1 ..... 706
L••••DC-SS ..... 129	LDC2 ..... 554	M•F• ..... 318	ME3162-32B ..... 705
L••••DP-SS ..... 129	LDCF2 ..... 554	M•M• ..... 318	ME3162-32S ..... 705
L••••E-SS ..... 129	LDCM2 ..... 554	M•S• ..... 318	ME502-12/8 ..... 704
L••••HSCRIP-SI ..... 130	LFV•• ..... 536	M16-••A ..... 383	MEP120B ..... 705
L••BU ..... 692	LFV••• ..... 536	M16-••M ..... 383	MEW• ..... 705
L0•BL ..... 695	LHC95 ..... 892	M16-03A ..... 906	MFB•• ..... 552
L03-0•A ..... 379	LHC95RB ..... 892	M16-03M ..... 906	MFC•• ..... 552, 553
L03-0•AMB ..... 379	LHFS400F ..... 803	M18-••A ..... 383	MFC•••• ..... 552
L07-•••A ..... 408	LHFS4045F ..... 803	M18-••M ..... 383	MFS•• ..... 552, 553
L07-200AC ..... 406	LHW ..... 801	M2•2-B ..... 318	MFS•••• ..... 552
L08-02A ..... 379	LJ••• ..... 688	M26-••A ..... 383	MGC• ..... 264
L14AM7-G•• ..... 567	LJ•••• ..... 688	M26-••M ..... 383	MGC•• ..... 264
L14AM7-G••• ..... 567	LJR•• ..... 688	M28-••A ..... 384	MGC••• ..... 264
L14AM7-G•••• ..... 567	LLBV2515F ..... 831	M28-••M ..... 384	MH• ..... 263
L14AM7-R•• ..... 567	LM••* ..... 92	M2B2 ..... 319	MH•• ..... 263
L14AM7-R••• ..... 567	LM••••* ..... 92	M30-••A ..... 384	MIC•• ..... 670
L14AM7-R•••• ..... 567	LOCKINGDEVICE ..... 798	M35-0•AMB ..... 385	MIC••• ..... 670
L14AM7V-R••• ..... 600	LOCKINGDEVICE6 ..... 798	M5834F ..... 239	MICAP•• ..... 671
L14AM7X-R••• ..... 600	LP•• ..... 74	M5834HM ..... 239	MICAP••• ..... 671
L16-••A ..... 392	LP•••• ..... 74	M5834M ..... 239	MICAP••G ..... 671
L16-••AMB ..... 392	LR•••• ..... 261	M7400-••• ..... 522	MIRU7550 ..... 657
L17-•••A ..... 418	LR••••• ..... 261	M7400-•••• ..... 522	MIU•• ..... 657
L17-•••D ..... 420	LR7 ..... 173	M7455-••• ..... 522	MIU••• ..... 657
L17-800APX ..... 419	LRHEZ•• ..... 130	M7455-•••• ..... 522	ML•00M ..... 369
L18-••A ..... 393	LRHEZ34 ..... 130	MA•• ..... 198	MLS•• ..... 202
L18-••AMB ..... 393	LRP-95-••• ..... 403	MA•••N ..... 199	MOC••F-• ..... 775
L2•2 ..... 322	LRP-96-••• ..... 403	MAH• ..... 263	MOC250NYC-P ..... 775
L26-••A ..... 393	LS•• ..... 275	MAH•• ..... 263	MOC250NYFD-P ..... 775
L26-••AMB ..... 393	LS••• ..... 275	MB•• ..... 198	MOC3025F-• ..... 775
L28-••A ..... 394	LSS•• ..... 275	MBV•• ..... 537	MOCA250F ..... 816
L28-••AMB ..... 394	LSS••• ..... 275	MC•• ..... 553	MP•••• ..... 260
L30-••A ..... 394	LV•N6D ..... 400	MC•••• ..... 257, 258	MP••••• ..... 256, 260
L30-••AMB ..... 394	LV•NAD ..... 400	MC••••• ..... 254, 257, 258	MPB-•••• ..... 894

	Page #		Page #		Page #		Page #
MPB-20Z-20	894	N37••F••F	777, 778	N56••F••F	772	P-4EA-SKIT	501
MPC•••••	894	N37••F••G	777, 778	NAPRAV••F••	834	P4F•	297
MPC-20Z-20	894	N37••F••S	777, 778	NAPRAVF•••••	834	P4F•-B	297
MPC-T••	896	N37••F••T	777, 778	NAPRAVGFT•••••	836	P4F6-9	297
MPR-T••	896	N37••G••F	777	NAPRAVGT•••••	836	P4F6-S	297
MPS•••••	894	N37••G••S	777	NAPRVF•••••	835	P4M•	298
MPS-20Z-20	894	N37••G••T	777	NAPRVFT•••••	836	P4M•-B	298
MRCH••	656	N37••S••F	777	NAPRVGT•••••	835, 836	P4M6-9	298
MRCH•••	656	N37••S••G	777	NCS-CSF-STZ•••	796	P4M6-S	298
MS•	73	N37••S••S	777, 778	NCS-CSF-STZ•••C	796	P8A-860•	421
MS••	73	N37••S••T	777, 778	NF307Y50GHT	737	PAP250	791
MS•••	553	N37••T••F	777, 778	NF307Y50GHT-KIT	737	PBC250	790
MS•••••T	740	N37••T••S	778	NF610Y100•••	737	PBLSS••	439
MS••X•	73	N37••T••T	778	NF610Y50•••	737	PBLSS•••	439
MS••X••	73	N3CS4	295	NF615100RAQT	737	PBLSS•••••	439
MS•X•	73	N4BF•	293	NF615-50RAQT	737	PCDVCHSS36	12
MS•X••	73	N4BF•-B	293	NF615Y100•••	737	PD•F•	482
MSA•••••F	795	N4BM•-B	294	NF615Y50•••	737	PD•M•	482
MSA•••••S	795	N4BM•-LS	294	NFSGX••	898	PD•OM•	482
MSA•••••T	795	N4DC	295	NFSGX1••	898	PEDF200	561
MSBC••SS	17	N4DC-B	295	NG••	689	PEDF75	561
MSBC••SSFL	17	N4F•	293	NK2S2	324	PF•	297
MSBC••SSMNPT	17	N4F•-B	293	NORG74DISPLAY	406	PF••	297
MSP•••	869	N4F•-B-LS	293	NPT•••TC	906	PF12SS	297
MSP4PAK	869	N4F6-S	293	NV•F	555	PFB••	297
MSP-95•••	401	N4M•-B	294	NV4M	555	PFB8	297
MT•••	446	N4M•-B-LS	294	NW••	689	PFC250F	789
MT•••••	696	N4M•-LS	294	NW•••	689	PFC250U	789
MT••••••	696	N4M6-S	294	NZ•••••	869	PFCW•••	789
MT•••••••	696	N4M6-S-LS	294	NZ•••••S	869	PFCW•••F	789
MTP-95•••	401	N4S•	295	NZ6540QCS	869	PFCW•••F-Y	789
		N4S•-B	295	NZMMEG5P•••	869	PFL••	297
		N4S•-B-LS	295	NZMQC5P•••	869	PFL••FS	298
N••	193	N4S•-B-LS-WF	296			PFL•FS	298
N•••	193	N4S•-B-WF	296	O•••BU	79, 81, 82	PFL12SS	297
N•••NO	194	N4S•-LS	295	O246BU	38	PFL8	297
N••CS	116	N4S•-LS-WF	296	O249BU	38	PFN4005•	764
N•BM•	294	N4S•-S	295	OA••	914	PFNB•••S	758, 856
N•F•-SS	293	N4S•-S-LS	295	OCTOE32	684	PFNB150NST	758, 856
N•M•	294	N4S•-WF	296	OCTOES32	684	PG700	372
N•M•-SS	294	N53••F••F	769	OCTS••	685	PG8083	907
N•S•-SS	295	N53••F••T	769			PGA•••NST	761
N35••F••F	770	N53••S••S	769	P••	219	PGA150NPSH	761
N35••S••F	770	N53••S••T	769	P••E-SKIT	500	PGH100	883
N35••S••S	770	N54••-25F25F	803	P••H-SKIT	455	PGH50	883
N36••F••F	785	N54••F••F	781	P••V-SKIT	470	PGS••	437
N36••F••T	785	N54••F••T	781	P•E-SKIT	500	PGS•••	437
N36••S••F	785	N54••S••S	781	P•H-SKIT	455	PGS•••••	437
N36••S••S	785	N54••S••T	781	P•V-SKIT	470	PHFA6	750, 820, 911
N36••S••T	785	N54L••F••F	781	P1A•••A	408	PHFA-B-A	820, 911
N36••T••F	785	N54L••F••T	781	P1A•••M	408	PHL•	298
N36••T••T	785						

Part Number Index

Index  
Part Number

Page #	Page #	Page #	Page #
PHL••FS ..... 298	PPCM•• ..... 250	PW6••B50••• ..... 735	R16••RG ..... 387
PHL••WF ..... 299	PPD•• ..... 185	PWH•• ..... 884	R16••RH ..... 387
PHL•FS ..... 298	PPD••• ..... 185	PWH••• ..... 884	R16••RHG ..... 387
PHL•WF ..... 299	PPDV75 ..... 840	PYLS•••• ..... 703	R17•••R ..... 413
PHL1• ..... 298	PPE•• ..... 186	PYLS••••• ..... 703	R17•••RG ..... 413
PHL12SS ..... 298	PPE••• ..... 186	Q•CAP ..... 295	R18••R ..... 387
PHLB1• ..... 298	PPF•• ..... 186	QB• ..... 295	R18••RG ..... 387
PHW ..... 800	PPF••• ..... 186	QB•• ..... 294, 295	R18-C05R ..... 413
PL••• ..... 368	PPH•• ..... 187	QB••WF ..... 296	R18-C05RG ..... 413
PL•••L ..... 368	PPH••• ..... 187	QB•WF ..... 296	R200SS ..... 171
PL400LWF ..... 369	PPLSS•• ..... 248	QB10• ..... 293	R21••R ..... 386
PL400WF ..... 369	PPM• ..... 249	QB8• ..... 293	R21••RG ..... 386
PLUG•••F-C ..... 791	PPN•• ..... 246	QBM• ..... 295	R26••R ..... 388
PLUG•••S-C ..... 791	PPN••• ..... 246	QM• ..... 295	R26••RG ..... 388
PM• ..... 298	PPP•• ..... 187	QM•• ..... 294, 295	R26••RH ..... 388
PM•• ..... 298	PPP••• ..... 187	QM••WF ..... 296	R26••RHG ..... 388
PM12SS ..... 298	PPSO150• ..... 764	QM•WF ..... 296	R28••R ..... 389
PMB1• ..... 298	PRC ..... 749	QM10• ..... 293	R28••RG ..... 389
PMB8 ..... 298	PRN••F ..... 749	QM8• ..... 293	R30••R ..... 389
PML• ..... 297	PRWB ..... 749	QMCAP ..... 295	R30••RG ..... 389
PML••FS ..... 298	PS•• ..... 433, 434	QSS•• ..... 294	R30••RH ..... 389
PML•FS ..... 298	PS-12HF12-B ..... 458	QSS103 ..... 293	R30••RHG ..... 389
PML12 ..... 297	PS403 ..... 401	QSS23 ..... 294	R364••C ..... 429
PML12SS ..... 297	PS417B ..... 405	QSS4 ..... 295	R364••CG ..... 429
PN••• ..... 684	PS-H12F12-B ..... 458	QSS83 ..... 293	R374-02C ..... 429
PN•••• ..... 684	PSM•••• ..... 891	QTF••••-F ..... 743	R374-02CG ..... 429
PN15 ..... 755	PSN76 ..... 862	QTF75GHT-F ..... 743	R40••RH ..... 390
PN15F ..... 755	PSNP•••NYFD ..... 792	QTM••••-F ..... 743	R40••RHG ..... 390
PNB75GHT ..... 862	PSNP250••• ..... 792	QTM75GHT-F ..... 743	R40-0•R ..... 390
PNS••• ..... 684	PSNP250S ..... 792	QTX150-F ..... 743	R40-0•RG ..... 390
PNS•••• ..... 684	PSW ..... 799	R•• ..... 219, 694	R43•••RG ..... 415
POLYHA•••• ..... 774	PSW• ..... 799	R•••BU ..... 694	R46•••R ..... 370
POLYHA15S15F ..... 774	PT•• ..... 446	R••• ..... 694	R46•••RG ..... 370
POLYHA2515F ..... 774	PTH•••AG ..... 408	R••BU ..... 694	R504•••• ..... 241
POLYHA2520T ..... 774	PTLS10040 ..... 703	R••P• ..... 90	R515100••• ..... 736
PP•VEU•-MG ..... 730	PTLS7540 ..... 703	R••P•LJR15 ..... 89	R515100•••/F ..... 736
PP•VFC•-MG ..... 729	PTP ..... 905	R••P•SOR15 ..... 89	R515100CBF ..... 736
PP•VFE•-MG ..... 729	PTTF150• ..... 764	R03-0•R ..... 377	R515100CBF/F ..... 736
PP•VMC•-MG ..... 729	PU••• ..... 891	R03-0•RG ..... 377	R515-50••• ..... 736
PP•VME•-MG ..... 729	PV•• ..... 545	R07•••R ..... 407	R515-50•••/F ..... 736
PP•VTEU•-MG ..... 730	PVFP•• ..... 545	R07•••RG ..... 407	R515-50CBF ..... 736
PP•VUC•-MG ..... 730	PVFP••• ..... 545	R07-200RGC ..... 406	R515-50CBF/F ..... 736
PP250F ..... 791	PVFPN•• ..... 546	R08-02RG ..... 378	R515U100•••/F ..... 735
PP250NYFD ..... 791	PVFPS200 ..... 546	R11•••RG ..... 413	R515U100CBF ..... 735
PPA•• ..... 184	PVFPSA200 ..... 546	R11••C ..... 430	R515U100CBF/F ..... 735
PPA••• ..... 184, 250	PV-HDWHL ..... 841	R11••CG ..... 430	R515U50••• ..... 735
PPB•• ..... 184	PV-KNOB ..... 841	R119••C ..... 430	R515U50•••/F ..... 735
PPB••• ..... 184	PVN200 ..... 546	R119••CG ..... 430	R515U50CBF ..... 735
PPC•• ..... 185	PW••F••F ..... 832	R16••R ..... 387	R515U50CBF/F ..... 735
PPC••• ..... 185	PW••S••S ..... 832		R72G•-R ..... 412
PPCF•• ..... 250	PW6••B100••• ..... 735		R72G•-RG ..... 412

	Page #		Page #		Page #		Page #
R72M•R	414	RDA••••EZ	153	RHA••S•F	772	RNB150S	759
R72M•RG	414	RDA90••EZ	157	RHA••S•T	772	RNW•••40	689
R73G•R	412	RDD••••EZ	154	RHA••T•F	772	RNW••40	689
R73G•RG	412	RDD•••EZ	154	RHC••	656	RPA-95•••	402, 405
R74G•R	413	RDL•••EZ	160	RHC•••	656	RPA-96•••	402
R74G•RG	413	RDM•	209	RHC••B	656	RPN••	223
R83-200R	414	RDM••	209	RHC••FS	656	RRHS••	206
R91-221RG	414	RDWBPST••EZ	162	RHC••G	656	RRP-95•••	402, 403
RA••	239	RDWSP••EZ	161	RHC••SS	656	RRP-95-590	405
RA•••	240	RE••••••	143	RHC••B	656	RRP-96•••	402, 403
RA•F•M	659	RE••BT	584	RHC••FS	656	RS15•••	740
RA79•	240	RE••NO	143	RHC••G	656	RS15••F	740
RAGG•••	697	RE••PF	142	RHC••SS	656	RSDM••	200
RAGG••••	697	RE••SE	584	RHEZ152	166	RSE••••F	803
RAM•	283	REL••••	665	RHEZ175	166	RSE••••F-C	803
RAM••	283	R-EN	24	RHEZ34	166	RSF••F	767
RAM•WF	287	R-EN-P	24	RHEZ6	166	RSF••F•T	767
RAM7T	287	R-EN-PLUG	24	R-HN	25	RSFSA••F	766
RAS••	241	REP••AS	817	RHN•••SS	662	RSFSA••F•T	766
RB•	71, 75	REP••AS•	817	R-HN-P	25	RSHR••	200
RB••	68, 71, 75	REP••HY	817	R-HN-PLUG	25	RSK••	200
RB••BL	133	REP••SP	817	R-HR	25	RSM••F	779
RB••EZ	133	REP••SP••	817	R-HR-C	25	RSM••S	779
RB12SC	70	REP250PT	817	R-HR-CAP	25	RSM••F•T	779
RB3-0•R	378	REP400AS/SP	817	RHS•	206	RSMSA••F	780
RB3-0•RG	378	R-ER	24	RHS••	206	RSMSA250F-Z	780
RBU•	75	R-ER-C	24	RHS•••	206	RSS••	207
RBU••	75	R-ER-CAP	24	RHSC152	165	RST•	190
RC••BL	135	RES••	201	RHSC175	165	RST••	190
RC••BLNO	135, 136	RES•••	201	RHSC34	165	RST•••	192
RC••BT	584	RFC••	787	RIC150F	816	RST••NOS	195
RC••CEZ	136	RFC••F	787	RJT•••SP	587	RST••A	191
RC••EZ	137	RFP••F	792	RK••	890	RST••CS	115
RC••EZ••	138	RFST••	193	RK••••	434	RST••PF	195
RC••EZCR	108, 137	RFST•••	193	RKB605WB	434	RSTB•	191
RC••EZNO	137, 138	RFST••CS	116	RKHN••	211	RSTB••	191
RC••EZPF	137	RG••••	261	RKR••Y	434	RSTB••CS	115
RC••SE	584	RG•••••	256, 261	RL••V	693	RSTV••	191
RC•F•F	655	RGB•	67, 68	RLC••EZ	128	RSTV••CS	115
R-CN	24	RGB••	67, 68	RLD200EZ	129	RTCA••	56
R-CN-P	24	RGF••	67	RLH••EZ	129	RTCT••	57
R-CN-PLUG	24	RGF••P•	69	RLP••	74	R-TN	25
R-CR	24	RGFAS11	70	RM•	210	R-TN-P	25
R-CR-C	24	RGFAS6	70	RMA•••	241	R-TN-PLUG	25
R-CR-CAP	24	RGMAS6	70	RMS•	73	R-TR	25
RD••BL	140	RH••BL	147	RMS••	73	R-TR-C	25
RD••EZ	141	RH••EZ	148	RN••	193, 211	R-TR-CAP	25
RD••EZHD	141	RHA••••	772	RN•••	193, 211	RTW150	741
RD15•••	740	RHA••••F	772	RN••NO	194	RWDGV250F	826
RD15193F	740	RHA••••T	772	RN••CS	116	RWDGV3025F	826
RDA•••BL	153	RHA••S••	772	RNB150NST	759	RWF••	71

Part Number Index

Index Part Number

Page #	Page #	Page #	Page #
	SCVJ• ..... 556	SFSA••••F-LH ..... 794	SM•••S ..... 779
S•• ..... 198	SCVL• ..... 556	SFSA••••S ..... 794	SM••F••T ..... 779
S••• ..... 198, 199	SCVL•• ..... 556	SFSA30••••F ..... 796	SM••F••T-D ..... 779
S••••• ..... 740	SCVM• ..... 556	SFSA30••••F-LH ..... 796	SM••S••F ..... 779
S•••••F ..... 740	SCVM•• ..... 556	SG••• ..... 270	SM515W50••• ..... 735
S••••X•••X120CS ..... 117	SCVR• ..... 556	SGH•• ..... 883	SMB1525 ..... 798
S••••X•••X090CS ..... 117	SCVS• ..... 365, 556	SGH••• ..... 883	SMB450 ..... 798
S••••X•••X120CS ..... 117	SCVS•• ..... 556	SGP••• ..... 798	SMV••• ..... 550
S•••N ..... 199	SD•• ..... 200	SGS••••NL ..... 798	SN••• ..... 551
S6175 ..... 831	SD•200 ..... 171	SGV••• ..... 829	SN•••• ..... 551
S6175S ..... 831	SD•300 ..... 171	SGV•••F ..... 833	SN75 ..... 862
S7100 ..... 831	SD•400 ..... 171	SGV30••• ..... 829	SO••• ..... 688
S7100-15 ..... 831	SDMP•• ..... 200	SGVF••• ..... 833	SO•••• ..... 688
S7100-15S ..... 831	SE•F•M ..... 665	SHA5045F ..... 797	SOE•• ..... 669
S7337S ..... 831	SE45•• ..... 667	SHD•S• ..... 322	SOE••• ..... 669
SA15Y57 ..... 434	SE45••• ..... 365, 667	SHD2•• ..... 321	SOR••• ..... 688
SA161X57 ..... 434	SE45•••G ..... 667	SHD4•• ..... 321	SOT•• ..... 669
SA200•W57 ..... 434	SE45••G ..... 667	SHP•• ..... 672	SOT••• ..... 669
SA4050AL ..... 48	SE90•• ..... 666	SHP••• ..... 672	SP•• ..... 261
SAEB••••• ..... 894	SE90••• ..... 666	SHP•••B ..... 672	SP••• ..... 256, 261
SAEC••••• ..... 894	SE90••B ..... 666	SHP•••FS ..... 672	SPF••• ..... 551
SAHW ..... 799	SE90••FS ..... 666	SHP•••G ..... 672	SRH360•••-G••• ..... 616
SAP• ..... 192	SE90••G ..... 666	SHP•••SS ..... 672	SRH360•••-R••• ..... 616
SAP•• ..... 192	SE90••SS ..... 666	SHP••FS ..... 672	SS••• ..... 204, 238, 270
SAR10Y57 ..... 434	SEGC0••••• ..... 900	SHP••G ..... 672	SS•••• ..... 807
SB•• ..... 198	SEGC1••••• ..... 900	SHP••SS ..... 672	SS16•63 ..... 450
SB••• ..... 198	SEGS0••••• ..... 900	SHS•• ..... 206	SS2404••• ..... 511
SB••N ..... 199	SEGS1••••• ..... 900	SHS••• ..... 206	SS2404••••• ..... 511
SBC•••AL ..... 18	SF•••F ..... 767	SIC250F ..... 816	SS2405••• ..... 511
SBC•••ALFL ..... 18	SF•••F• ..... 767	SIC250F• ..... 816	SS2405••••• ..... 511
SBC•••ALMNPT ..... 18	SF•••F-D ..... 767	SJSS••BB-20 ..... 619	SS2501••• ..... 513
SBC•••ALTMA ..... 18	SF•••NYFD ..... 767	SJSS••CC ..... 619	SS2501••••• ..... 513
SBC•••SS ..... 18	SF•••S ..... 767	SJSS••CC-20 ..... 619	SS337 ..... 71
SBC•••SSFL ..... 18	SF••F••T ..... 767	SK•• ..... 200	SSA•• ..... 857
SBC•••SSMNPT ..... 18	SF••F••T-D ..... 767	SK1098 ..... 274	SSA•••• ..... 797
SBC-E300CC13 ..... 577	SF•20FGXFGCS00 ..... 55	SL•• ..... 292	SSBV•• ..... 539
SBC-E300TP13 ..... 592	SF•20FGXFGCS10 ..... 55	SL••• ..... 758, 856	SSBV••• ..... 539
SBCS ..... 290	SF•20WXWCS00 ..... 55	SL•••CR ..... 291	SSBV•••SR ..... 541
SBDV•• ..... 833	SF•20WXWCS10 ..... 55	SL•••F ..... 291	SSBV•••TW ..... 538
SBG ..... 290	SF1471••• ..... 60	SL•••H ..... 291	SSBV••SR ..... 541
SC••• ..... 281	SF1631••• ..... 60	SL•••M ..... 291	SSBV••TW ..... 538
SC•••• ..... 281	SFBTFLY••••F ..... 842	SL075GHT ..... 758, 856	SSC•• ..... 234
SC•••ABS ..... 798	SFC••• ..... 550	SL150NST ..... 758, 856	SSCAP•• ..... 671
SC•••NL ..... 798	SFC•••• ..... 550	SLP1 ..... 292	SSCF•• ..... 234
SCCW••• ..... 281	SFJCT••CS ..... 115	SLR• ..... 292	SSCF7•• ..... 234
SCCW•••• ..... 281	SFJM••• ..... 517	SLS••• ..... 202	SSC-T••-1 ..... 897
SCM•• ..... 448	SFJM•••• ..... 517	SLS4 ..... 68	SSC-T••-2 ..... 897
SCS4025F ..... 808	SFJM•••••-45 ..... 517	SLT10050 ..... 820, 907	SSCVIL••• ..... 559
SCV••• ..... 558	SFJM•••••-90 ..... 517	SM•••F ..... 779	SSE•• ..... 911
SCVH• ..... 556	SFJM•••••-90 ..... 517	SM•••F-D ..... 779	SSGV•• ..... 547
SCVH•• ..... 556	SFSA••••F ..... 794	SM•••NYFD ..... 779	SSGV••• ..... 547

	Page #		Page #		Page #		Page #
SSLBV••	540	STC••CS	115, 117	SWMF-RK•	845	TCR-T••••	897
SSLBV•••	540	STC-180•-R••	616	SWMF-RK••	845, 848	TCS••••F	810
SSLBV•••SP	540	STC-360-R••	616	SW-S400	802	TCS••••F••	810
SSLBV••SP	540	STC-RK••	616	SZW2	802	TCT••	57
SSPM•	225	STFC•	498	SZW2-NL	802	TES••••	895
SST••	669	STFC••	498	T••	688, 698	TETF4AL	36
SST•••	669	STFC•SS	498	T•••	688, 698	TETF4ALFP50	36
SST10	372	STFP•	499	T••••	688, 698	TETFG4AL	36
ST•	190	STFP••	499	T•DC	495	TF••	247
ST••	190	STFP•B	499	T•F•	494	TF••WF•-80	90
ST•••	190	STFP•SS	499	T•W7	242	TFK	354
ST••BF••	480	STMC•	498	T16AMP-•••••PL	630	TFN150•••	760
ST••F••	480	STMC••	498	T16AMP-•••••PM	630	TFN150NST•••	760
ST••OF••	480	STMC•SS	498	T16AMP•••PL	630	TFS••	247
ST••PF	195	STMP•	499	T16AMP•••PM	630	TFV••	554
ST••SKIT	481	STMP••	499	T16W•••PL	630	TFV2HB	554
ST•BF•	480	STMP•B	499	T16W•••PM	630	TG••	88
ST•BF••	480	STMP•SS	499	T2CM•••PL	625	TG•••	88
ST•BF••SS	480	STR2••••	686	T2CM•••PM	625	TG••••	89
ST•BF••SS	480	STR3••••	687	T2CMP•••PL	625	TG•••••	89
ST•BF••V2	480	STR6648	687	T2CMP•••PM	625	TGL••	88
ST•DC-A	481	STV••	191	T2KM•••PL	626	TGL•••	88
ST•F•	480	STV•••	191	T2KM•••PM	626	TGL••••	89
ST•F••	480	STV••CS	115, 117	T2KMP•••PL	626	TGR••	88
ST•F•••SS	480	STW••	741	T2KMP•••PM	626	THB••	673
ST•F•••V2	480	SUBV••	546	T2KS•••PL	625	THN••	246
ST•F•••SS	480	SUBV•••	546	T2KS•••PM	625	TL14AM7•••PL	567, 630
ST•F•••V2	480	SUBVN100	546	T2S•••PL	625	TL14AM7•••PM	630
ST•OF•	480	SV••	447, 557	T2S•••PM	625	TLFS••	248
ST•OF••	480	SV•••	365, 557	T3F3-SS	494	TLS••	248
ST••SKIT	481	SV•••HD	557	T600-60F	689	TLSS••	248
ST16DC-A	481	SV•••SS	557	T7MP•••PL	627	TLT••	251
ST16F16-SS	480	SV•••HD	557	T7MP•••PM	627	TM•	249
ST204B	270	SV••SS	557	T7RWWW•••••PL	626	TM••	88, 249
ST205G	270	SW••	200, 802	T7RWWW•••••PM	626	TM•••	88
ST206R	270	SW•••	200, 741, 750, 754, 785, 857	T7WWM•••PL	627	TM••••	89
ST8DC-A-V2	481	SW•••••••	679	T7WWM•••PM	627	TM•••••	89
STB•	191	SW•••F	741, 754, 857	T7WWM•••PL	627	TML••	88
STB••	191	SW153	802	T7WWM•••PM	627	TML•••	88
STB•••	191	SW1530	802	T7WWW•••PL	626	TML••••	89
STB••CS	115	SW250	792	T7WWW•••PM	626	TMR••	88
STBC•••	276	SW300F	792	TA•••	251, 673	TMR••••	88, 89
STBC••••	276	SWB-2	802	TA•••F	251	TN	23
STBC••••L	278	SWB-S•	802	TBC•••	276	TN••	246
STBC•••L	278	SWCV••	560	TC97	892	TN•••	246
STC•	190	SWCV•••	560	TC97RB	892	TN••••	246
STC••	190	SWDS	864	TCF•	676	TN•••X•	661
STC•••	190	SWDSHOSE••	880	TCF••	247, 250	TN•••X•SS	661
STC••••	192	SWG300-4	907	TCM••	250	TN-P	23
STC•••••	192	SWMF•••	848	TCMR-T••	897	TN-PLUG	23
STC••A	191			TCN••	674	TP••	88



Part Number Index

Part Number Index

Page #	Page #	Page #	Page #
TP...	88	TUN...FS	657
TP...	89	TUN...SS	657
TP...	89	TUN-F	657
TPF..	252	TUN0..G	657
TPG	909	TVPC200-300	641
TPL..	88	TVS7-30	242
TPL...	88	TVSEC-G...	640
TPM.	252	TWGV25	907
TPN..	252	TYP2501-..	375
TPP140	872		
TPR..	88	U...	723, 724
TPR...	89	UHGV250F	827
TPS.	676	UHGV250F-D	827
TPS..	676	UHGV250-W	827
TPX.	676	UPP250F	750, 755
TPX..	676	UPP250F-SPEC	755
TR	23	UPPT	755
TR...	688	UPPT...	755
TR-BF.	472	USBG	290
TR-F.	472	USW	799
TR-C	23		
TR-CAP	23	V..BF..	465
TSA..	673	V..BF..-B	465
TSE..	675	V..BF..-B-E	468
TSS..	206	V..BF..-E	468
TSSS...	249	V..BF..-SS	465
TSST...	249	V..BF..-SS-E	468
TT-50	902	V..DC-A	469
TT-75	902	V..F..	465
TT-ASG	38	V..F..-B	465
TT-ASG-ETH	38	V..F..-B-E	468
TT-ASGOE	38	V..F..-E	468
TT4ASG-ETH	38	V..F..-SS	465
TT4ASG-ETHOE	38	V..F..-SS-E	468
TTA50LP	902	V..JM..	464
TTA50SS	902	V..M..	464
TTB100	902	V..M..-B	464
TTBP50	902	V..M..-E	467
TTC.	676	V..M..-SS	464
TTF-AL-EMT	35	V..M..-SS-E	467
TTF-AL-MT	35	V..OF..	465
TTF400SP	35	V-BF.	465
TTF4AL-FT	35	V-BF-B	465
TTFS4AL-FP50	36	V-BF-B-E	468
TTFS4SS	38	V-BF-E	468
TTFST-CS	116	V-BF-SS	465
TTFST-CS-THK	116	V-BF-SS-E	468
TTPM...	902	V-BRKIT	471
TTPM...	902	V-DC-A	469
TTPM...	902	V-F.	465
TTPM...	902	V-F-B	465
		V-F-B-E	468
		V-F-E	468
		V-F-SS	465
		V-F-SS-E	468
		V-JM.	464
		V-M.	464
		V-M-B	464
		V-M-B-E	467
		V-M-E	467
		V-M-SS	464
		V-M-SS-E	467
		V-OF.	465
		V-RKIT	471
		V-SSRKIT	471
		V2DC	469
		VEP..BF..	484
		VEP..DC-A	484
		VEP..F..	484
		VEP..F..-BOP	486
		VEP..FH..	485
		VEP..FP..	485
		VEP..OF..	484
		VEP-BF.	484
		VEP-DC-A	484
		VEP-F.	484
		VEP-F-BOP	486
		VEP-FH.	485
		VEP-FP.	485
		VEP-OF.	484
		VHC...	454, 463, 469
		VHC...	463
		VHC...B	463
		VHC...NV	466
		VHC...SS	463
		VHCN...	460, 469
		VHN...	465, 469
		VHN...	465
		VHN...B	465
		VHN...NV	468
		VHN...SS	465
		VN...-200	699
		VNR...-200	699
		VR...CS-AL	34
		VR...CS-AL45	34
		VR4030CS-AL	33
		VR4030CS-SH	34
		VR4040CS-4MNPT	34
		VR4040CS-AL	33
		VR4040CS-ALS45	34
		VR4040CSRK.	33, 34
		VR4050AL	47
		VR4050PL	47
		VR4086	46
		VR4086-BY	46
		VR6200	43
		VR6200NP	43
		VRC3000AL	33
		VRHK	34
		VRHK-C	34
		VT	21
		VT7	21
		VT9	21
		VTT	21
		VTX	21
		VTX-9	21
		W.	72
		W..	72
		W...-U	524
		W..BF..-B	488
		W..-BMF	488
		W..DC	488
		W..F..-B	488
		W..-RKIT-V2	489
		W-BF-B	488
		W-BMF	488
		W-DC	488
		W-F-B	488
		W-RKIT-V2	489
		W104-..	524
		W104-...	524
		W106-..	524
		W106-...	524
		W4-...-U	525
		W4-..-U	525
		W43-...-U	524
		W44-...-U	524
		W44-..-U	524
		W45-..	524
		W45-...	524
		W46-...-U	524
		W46-..-U	524
		W48-...-U	524
		W48-..-U	524
		W49-..	524
		W49-...	524
		W59-...-U	525
		W59-..-U	525
		W60-..	525
		W60-...	525
		W61-..	525
		W61-...	525

	Page #		Page #		Page #
WA•	362	WS•DC-A	492		
WA2B	362	WS•F•	490		
WA2SS	362	WS•F•-BOP	493		
WA4FL12X••••	83	WS•F•-SS	490		
WA4FL12X•••••	83	WS•F•-SS-BOP	493		
WB•	362	WS•FH•	491		
WB1C	362	WS•OF•	490		
WB1SS	362	WS•BF•	490		
WBC	72	WS•BF•-SS	490		
WBN•••	363	WS•DC-A	492		
WD•01ALVB	39, 548	WS•F•	490		
WD•04ALVB	39, 548	WS•F•-BOP	493		
WD40	908	WS•F•-SS	490		
WDGV•••F	825, 826	WS•F•-SS-BOP	493		
WDGV250NYFD	825	WS•FH•	491		
WDGV3025F	826	WS•FP•	491		
WDH•BK••GAX	879	WS•OF•	490		
WDH•BK••KAF	879	WSB••	893		
WDH•BK••KAS	879	WSB••••	893		
WDH•BK••RAF	878	WSB•••••	893		
WDH•BK100RAF	878	WSB••T	893		
WDH•BK100RAS	878	WSB••T•••	893		
WDH•BK100RAT	878	WSB-20Z	893		
WDH•BK100UC	880	WSR•	362		
WDH•BK50RAS	878	WSR•SS	362		
WDH•BK50RAT	878	WSR1•	362		
WDH•BK50UC	880	WSS•	265		
WDN150	857	WTB-T•	896		
WDN150NST	857	WTB-T•Z	896		
WDS1	864	X02-04	400		
WDSR	864	X02-04MB	400		
WF•	71	X03-02	386		
WF••	71	X03-02MB	386		
WF•••	71	X27	280		
WF26-1	71	XLS••A0120P	652		
WH300•	171	XPO•4F	652		
WH400•	171	XSO-4•••-0A	652		
WHYD••••F	830	Y•••	703		
WILK26DISPLAY	405	Y10075	367		
WM•	72				
WM••	72				
WN••	685				
WN•••	689				
WN1000	689				
WOC-T•	896				
WP2H••••	814				
WP2H•••••	814				
WP2H-ASSP•	814				
WP3H••••	814				
WS•BF•	490				
WS•BF•-SS	490				

## Limited Warranty

DIXON VALVE AND COUPLING COMPANY (herein called "Dixon") warrants the products described herein, and manufactured by Dixon to be free from defects in material and workmanship for a period of one (1) year from date of shipment by Dixon under normal use and service. Its sole obligation under this warranty being limited to repairing or replacing, as hereinafter provided, at its option any product found to Dixon's satisfaction to be defective upon examination by it, provided that such product shall be returned for inspection to Dixon's factory within three (3) months after discovery of the defect. The repair or replacement of defective products will be made without charge for parts or labor. This warranty shall not apply to: (a) parts or products not manufactured by Dixon, the warranty of such items being limited to the actual warranty extended to Dixon by its supplier; (b) any product that has been subject to abuse, negligence, accident, or misapplication; (c) any product altered or repaired by others than Dixon; and (d) to normal maintenance services and the replacement of service items (such as washers, gaskets and lubricants) made in connection with such services. To the extent permitted by law, this limited warranty shall extend only to the buyer and any other person reasonably expected to use or consume the goods who is injured in person by any breach of the warranty. No action may be brought against Dixon for an alleged breach of warranty unless such action is instituted within one (1) year from the date the cause of action accrues. This limited warranty shall be construed and enforced to the fullest extent allowable by applicable law.

Other than the obligation of Dixon set forth herein, Dixon disclaims all warranties, express or implied, including but not limited to any implied warranties of merchantability or fitness for a particular purpose, and any other obligation or liability. The foregoing constitutes Dixon's sole obligation with respect to damages, whether direct, incidental or consequential, resulting from the use or performance of the product.

Some products and sizes may be discontinued when stock is depleted, or may require a minimum quantity for ordering.

---

## Limits of Liability

This catalog is intended as a product offering. It is not intended to be a user or technical manual. Information in this catalog is subject to change without notice. All users and distributors of products sold through this catalog should contact Dixon® with questions of use, compatibilities, coupling procedures and life of product. Our full-time engineering and test staff are always available to recommend uses and to assist distributors and users with any questions.



---

## Safety



Safety logos, which appear throughout our catalog, are used as a reminder that the user should carefully review for the appropriateness of the product for the media, application and environment in which it will be used.

NOTE: Because of the health hazards associated with contamination and lead content in drinking water systems, Dixon® couplings, unless otherwise specifically approved, are not recommended for potable water service and should not be used in applications where drinking water will contact the wetted surfaces of the coupling.

Warning: Dixon® products may contain chemicals known to the State of California to cause cancer, birth defects, or other reproduction harm.



---

## Trademarks

Delrin® and Zytel® are registered trademarks of E.I. duPont Nemours and Company.

Kalrez® is a registered trademark of DuPont Dow Elastomers.

All other trademarks appearing in the Dixon® Illustrated Price List are the property of their respective owners.

---

## Copyright

Copyright © 2018 by Dixon Valve and Coupling

All rights reserved. This book is copyrighted material. Use, reproduction or copying of it by anyone other than Dixon® is strictly forbidden without its express written consent.

NOTE: Reasonable care has been taken in preparing this catalog. Dixon Valve & Coupling Company reserves the right to make corrections.



Dixon®  
 ph 877.963.4966  
 fx 800.283.4966  
 dixonvalve.com

United States

**Albany, NY**  
 ph 518.725.0998  
 178A Corporate Drive  
 Gloversville, NY 12078  
 nysales@dixonvalve.com

**Atlanta, GA**  
 ph 770.486.9619  
 101 T.D.K. Boulevard  
 Suite A  
 Peachtree City, GA 30269  
 gasales@dixonvalve.com

**Dallas, NC**  
 ph 704.376.5755  
 2925 Chief Court  
 Dallas, NC 28034  
 ncsales@dixonvalve.com

**Chestertown, MD**  
 ph 800.355.1991  
 800 High Street  
 Chestertown, MD 21620  
 sales@dixonvalve.com

**Chicago, IL**  
 ph 630.323.4442  
 1011 N. Hilltop Drive  
 Itasca, IL 60143  
 chsales@dixonvalve.com

**Cleveland, OH**  
 ph 330.425.3000  
 1900 Enterprise Parkway  
 Twinsburg, OH 44087  
 ohsales@dixonvalve.com

**Houston, TX**  
 ph 713.678.4291  
 6525 Homestead Road  
 Houston, TX 77028  
 txsales@dixonvalve.com

**Kansas City, MO**  
 ph 816.221.0064  
 1244 Saline Street  
 N. Kansas City, MO 64116  
 kcsales@dixonvalve.com

**Los Angeles, CA**  
 ph 909.605.6400  
 8840 Flower Road  
 Suites 150/160  
 Rancho Cucamonga, CA 91730  
 casales@dixonvalve.com

**Portland, OR**  
 ph 503.289.0400  
 2642 North Marine Drive  
 Portland, OR 97217  
 plsales@dixonvalve.com

**Salt Lake City, UT**  
 ph 801.972.1180  
 McGillis Ind. Pk. Suite A  
 1972 South 4370 West  
 Salt Lake City, UT 84104  
 utsales@dixonvalve.com

**Tampa, FL**  
 ph 813.247.3500  
 5120 Adamo Drive  
 Suite E  
 Tampa, FL 33619  
 fsales@dixonvalve.com

Dixon Divisions

**Dixon Bayco**  
 ph 800.355.1991  
 800 High Street  
 Chestertown, MD 21620  
 fx 410.778.4702 • 800.283.4966

**Dixon Brass**  
 ph 800.323.4440  
 40 Chestnut Ave.  
 Westmont, IL 60559  
 fx 800.628.7259

**Dixon Eagle**  
 ph 800.314.9246  
 33 Plan Way, Bldg 5  
 Warwick, RI 02886  
 fx 401.732.2201

**Dixon Fire**  
 ph 877.712.6179  
 800 High Street  
 Chestertown, MD 21620  
 fx 410.778.9525

**Dixon Quick Coupling**  
 ph 704.334.9175  
 2925 Chief Court  
 Dallas, NC 28034  
 fx 704.334.9002

**Dixon Sanitary**  
 ph 800.789.1718  
 N25 W23040 Paul Road  
 Pewaukee, WI 53072  
 fx 800.789.4046

**Dixon Specialty Products**  
 ph 888.226.4673  
 225 Talbot Blvd  
 Chestertown, MD 21620  
 fx 410.778.1958

International

**Wingfield SA,  
 Australia**  
 ph 61.8.8202.6000  
 fx 61.8.8202.6099

**Edmonton, Alberta,  
 Canada**  
 ph 780.469.5444  
 fx 780.463.9205

**Innisfil, Ontario,  
 Canada**  
 ph 705.436.1125  
 fx 705.436.6251

**Montreal, Quebec,  
 Canada**  
 ph 514.422.9292  
 fx 514.422.0166

**Preston, England**  
 ph 44.1772.323529  
 fx 44.1772.314664

**Paris, France**  
 ph 33.171.841016  
 fx 33.171.841019

**Troisdorf-Spich,  
 Germany**  
 ph 49.2241.84406.0  
 fx 49.2241.8440679

**Monterrey, Mexico**  
 ph 52.81.8354.5649  
 fx 52.81.8354.8197

**St. Petersburg,  
 Russia**  
 ph 7.812.677.5447  
 fx 7.812.956.4782

**Singapore**  
 ph 65 6232 5272  
 fx 65 6232 5270

**Sharjah,  
 United Arab Emirates**  
 ph 971.657.41488  
 fx 971.657.41484



The Right Connection®



DPL417  
 INDEX

A

Engineered Fluid  
 Transfer Couplings  
 pages 4 - 65

B

Hose  
 Coupling Systems  
 pages 66 - 118

C

Cam & Groove  
 pages 119 - 188

D

Industrial Hose  
 Fittings  
 pages 189 - 261

E

Clamps  
 pages 262 - 281

F

Pneumatic  
 Fittings  
 pages 282 - 360

G

Pneumatic  
 Accessories  
 pages 361 - 448

H

Hydraulic Fittings  
 pages 449 - 530

I

Valves  
 pages 531 - 562

J

Sanitary Fittings  
 pages 563 - 652

K

Pipe, Welding &  
 Tube Fittings  
 pages 653 - 730

L

Fire Fittings &  
 Accessories  
 pages 731 - 843

M

Nozzles, Spray Guns  
 & Accessories  
 pages 844 - 872

N

Hose & Tubing  
 pages 873 - 900

O

Maintenance and  
 Repair  
 pages 901 - 914

P

Safety & Technical  
 pages 915 - 948

Q

Index  
 pages 949 - 992

Uncommon Excellence • Uncommon Excellence • Unc