



INDUSTRIAL HEALTH & SAFETY PRODUCT CATALOG



About Bullard



Bullard is a manufacturer of high-quality personal protective equipment and systems designed to help save lives around the world. Serving the industrial market for more than a century, Bullard manufactures head, face, and respiratory equipment that provide workers with high-quality, on-the-job protection they trust and rely on.

Market Leader

Bullard maintains its competitive edge through advanced engineering technologies, research and development, and value-added services to develop the most sophisticated, quality-driven, advanced products designed with worker safety in mind. From the time we invented the hard hat in 1919, our Company began a legacy of creating products that are uniquely designed with input from our customers.

Protection

The first Bullard hard hat was the beginning of the Company's prominence as an industry leader in head protection. Today, Bullard offers a full line of hard hats that have revolutionized the industry by providing workers with superior performance, unmatched quality, durability, and added comfort. Worker safety is always paramount when designing Bullard products, so it was no surprise when Bullard became involved with the safety issues of workers constructing the Golden Gate Bridge in the 1930s. Bullard supplied the hard hats for the entire Golden Gate Bridge workforce and provided workers with the original supplied air respirator for blasting the steelwork.

Today, Bullard is a leader in respiratory protection equipment offering powered air-purifying respirators, airline respirators, pressure demand systems, supplied air filters and monitors, and a full range of breathing air pumps. Bullard respiratory products meet National Institute for Occupational Safety and Health (NIOSH) standards and provide high-quality protection to workers worldwide.

Innovation

Bullard continues to lead the industry with innovative products and accessories designed specifically to meet the needs of today's workforce. The Company's Powered Air-Purifying Respirators (PAPRs) are the latest in cutting-edge technology and air flow, offering users unrivaled protection and comfort. In 2013, the Company introduced the GenVX® Blast Helmet, providing users with the industry's lightest, coolest, most comfortable, and most dependable helmet on the market. Bullard's latest innovation, the ICE Pump, offers users a mobile ambient air pump that provides cool, clean, breathable air. With Bullard products, you'll find the ultimate in functionality and durability. You'll also find extraordinary service and the most innovative designs.

Table of Contents



Terms and Conditions	1
Information	2
Industrial Head and Face Protection Products.....	3
Regulations and Standards for Industrial Head Protection	4
Regulations and Standards for Head and Face Protection.....	5
Advanced Head Protection.....	7
Advent® Helmet	7
Vector Helmet	9
Classic Series Hard Hats and Caps	14
Standard Series Hard Hats and Caps	17
Bump Caps	24
Industrial Head Protection Replacement Parts	27
Logo Shop.....	28
Reflective Striping	34
Face Protection.....	36
Body Temperature Management	44
The Turtle Club®.....	46
Respiratory Protection and Air Quality Products	48
Warnings, Regulations, Standards, and Protection Factors Research for Respirators	49
Powered Air-Purifying Respirators (PAPRs)	59
EVA Powered Air-Purifying Respirator	61
Sparxlift for EVA Powered Air-Purifying Respirator	67
Guidance for PAPRs in Hazardous Locations	73
EVAHL Powered Air-Purifying Respirator	75
PAPR Replacement Head Pieces, Parts and Accessories.....	81
Supplied Air Respirators (SARs)	90
CC20 Series Airline Respirator	93
20LF Series	109
RT Series Airline Respirator	117
Blasting and Grinding Respirators.....	126
GenVX® Series Airline Respirator	127
88VX Series Airline Respirator.....	139
GR50 Series Airline Respirator.....	153
Mask-Style Respirators.....	162
Spectrum Series®.....	162
FAMB2 Half-Mask Airline Respirator	181
Sparxlift for Supplied Air Respirator	185
Breathing Air Supply Hose	194
Personal Climate	201
Air Quality and Filtration.....	207
41 Series Airline Filters.....	208
Clean Air Box (CAB) Series Breathing Air Filtration.....	211
Free-Air® Pumps.....	218

Terms and Conditions

Customer Service Policy: This statement does not supersede the terms or conditions of sale that are printed on Bullard sales orders, acknowledgments, and packing slips. Instead, it is a guide to our customer service policies. Bullard reserves the right to change product specifications without notice.

Pricing: Orders must specify one destination and one shipping date. Prices are subject to change without notice. We attempt to advise our customers of price changes in advance but cannot guarantee to do so. Orders specifying future shipment are subject to prices effective at the time of shipment. Possession of a price list does not grant the right to distributor discounts.

Minimum Order: Minimum purchase order is \$100.00. Products from other Bullard price lists may be combined to meet minimum.

Terms: Standard terms net 30 days, F.O.B. shipping point.

Freight: Title to goods passes to the buyer upon delivery to the carrier at the Bullard dock. Orders of \$2,500 or more are shipped freight prepaid by Bullard within the continental U.S. and Canada via the carrier(s) of our choice. Products from other Bullard price lists may be combined to receive free freight. Orders specifying other means of shipment are shipped collect regardless of order value. To qualify for prepaid freight, orders must specify a single destination and shipping date.

Credit Policy: We reserve the right to assess a 1.5% service charge per month on overdue balances. Our credit department is authorized to hold shipments if past due balances are not paid.

Returned Goods: Refer to your Bullard distributor program for details.

Non-standard Orders: We welcome the opportunity to meet special requirements. However, special orders are accepted with the understanding that we may over-ship and bill accordingly by as much as 10% of the order, due to the special nature of the product.

Drop Shipments: In certain situations, drop shipments may be made to authorized distributor locations or other locations within a distributor's recognized territory. Please contact Bullard Customer Service for details.

Information Support Policy: Bullard provides distributors with catalogs, price lists, promotional literature, and other printed material. Generally, this information is provided to the distributor at no cost. However, Bullard reserves the right to charge a distributor when literature requests exceed reasonable levels based on the distributor's annual sales volume. All Bullard literature can also be downloaded from our website at no additional cost at www.bullard.com.



Contact and Ordering Information

Now there are more ways than ever to place an order with Bullard!

Fax

You can fax us any time – 24 hours a day. Faxed orders are processed promptly, and you will receive a Sales Order Confirmation back after the order has been entered into our system.

Toll-Free Fax Number: 1-800-877-6858

Local Fax Number: 1-859-234-6858

E-mail

E-mail your orders to orders@bullard.com.

EDI

Transaction sets are received as soon as they are sent, so the response turnaround is almost immediate. You can even use your own part numbers! Contact edi@bullard.com if you wish to become an EDI partner. **NOTE:** There is a \$100 purchase order minimum.

Mail

Send orders via mail to Bullard Customer Service if you have an account set up with us. The mailing address for Bullard is below.

In Person Contact

Your Bullard Regional Sales Manager will visit your facility and listen to your needs. They can help you decide on the combination of safety products that will best serve you and provide a quote, technical information, product availability, and ordering information.

Call us

Call us anytime between 8:00 a.m. and 6:00 p.m. EST, Monday through Friday, and one of our experienced Customer Service Representatives will assist you with preparing your order. Special order requirements? Just contact a Bullard Customer Service Representative to discuss the options. We do not take orders over the phone; you must e-mail or fax a copy of the purchase order.

Americas:

Bullard

1898 Safety Way
Cynthiana, KY 41031-9303
Toll free within USA:
877-BULLARD (285-5273)
Tel: +1-859-234-6616
Fax: +1-859-234-8987

Europe:

Bullard GmbH

Lilienthalstrasse 12
53424 Remagen
Germany
Tel: +49-2642 999980
Fax: +49-2642 9999829

Asia-Pacific:

Bullard Asia Pacific Pte. Ltd.

LHK Building
701, Sims Drive, #04-03
Singapore 387383
Tel: +65-6745-0556
Fax: +65-6745-5176



Don't Forget to Visit Us Online!

Check out our website and follow us on Facebook and YouTube.

www.bullard.com

www.facebook.com/BullardCompany

www.facebook.com/BullardER

www.facebook.com/BullardIHS

www.youtube.com/BullardTV



Industrial Head and Face Protection Products

Regulations and Standards for Industrial Head Protection

Types of Hard Hats

Type I/1 – Conventional hard hats that are designed to reduce the force of impact to the top of the head, neck, and spine.

Type II/2 – Designs that offer additional impact protection to the front, sides, and back, as well as the top of the head.

Bullard Model	Standard	Type and Class
 C30	ANSI/ISEA Z89.1-2014 CSA Z94.1-2005	Type I, Class E & G,  , LT, HV Type 1, Class E & G
 C33	ANSI/ISEA Z89.1-2014 CSA Z94.1-2005	Type I, Class E & G,  , LT, HV Type 1, Class E & G
 C34	ANSI/ISEA Z89.1-2014	Type I, Class E & G,  , LT, HV
 C35	ANSI/ISEA Z89.1-2014	Type I, Class E & G
 911C	ANSI/ISEA Z89.1-2014	Type I, Class E & G,  , LT, HV
 911H	ANSI/ISEA Z89.1-2014	Type I, Class E & G,  , LT, HV
 S51	ANSI/ISEA Z89.1-2014 CSA Z94.1-2005 EN 397-2012	Type I, Class E & G,  , LT, HV Type 1, Class E & G Type 1, Class E & G, LT
 S61	ANSI/ISEA Z89.1-2014	Type I, Class E & G,  , LT, HV
 S62	ANSI/ISEA Z89.1-2014	Type I, Class C,  , LT, HV
 S71	ANSI/ISEA Z89.1-2014	Type I, Class E & G,  , LT, HV
 Advent®	ANSI/ISEA Z89.1-2014	Type II, Class E & G, LT
 Vector	ANSI/ISEA Z89.1-2014 CSA Z94.1-2005	Type II, Class E & G, LT, HV Type 2, Class E & G

National Standard for Canada CAN/CSA Z94.1-2005 - www.csa.ca

This is the fifth edition of CSA Z94.1, Industrial Protective Headwear Performance, Selection, Care and Use. It supersedes the previous editions published in 1992, 1977, and 1966 under the title Industrial Protective Headwear. It also supersedes the Preliminary Standard, published in 1965, and replaces the protective headwear requirements specified in CSA Z94-1948, Code for Head and Eye Protection. Bullard's S51, C30, and C33 all meet CSA Z94.1-2005, Type 1, Class E & G; Bullard's Vector meets CSA Z94.1-2005, Type 2, Class E & G.

European Standard for Industrial Safety Helmets EN 397:2012

EN 397:2012 certifies that safety helmets are designed to offer protection from lateral impact or top impact. It supersedes EN 397:1995. This European Standard specifies physical and performance requirements, methods of test, and marking requirements for industrial safety helmets. The mandatory requirements of EN 397 apply to helmets for general use in industry in the European Union as mandated by 89/686/EEC for personal protective equipment. Additional optional performance requirements are included to apply only where specifically claimed by the helmet manufacturer. Industrial safety helmets (also known as headgear) are intended primarily to provide protection to the wearer against falling objects to avoid brain injury and skull fracture. EN 397:2012 is written by Technical Committee CEN/TC 158 on "Head Protection." Countries in Europe are expected to adopt it as a national standard, either by publication of an identical text or by endorsement.

Classes of Hard Hats

Class E (electrical) hats are tested to withstand 20,000 volts.

Class G (general) hats are tested at 2,200 volts.

Class C (conductive) hats provide no electrical protection.

OSHA 29 CFR 1910.135 - www.osha.gov

This standard requires head protection if any aspect of the work environment presents a risk of head injury.

National Standard for U.S. ANSI/ISEA Z89.1-2014 - www.ansi.org or www.safetyequipment.org

This standard provides performance and testing requirements for industrial helmets (commonly known as hard hats). It establishes the types and classes of protective helmets, depending on the type of hazard encountered. It includes specifications for helmets designed to offer protection from lateral impact (Type II), or top-only impact (Type I), giving employers and users the flexibility to specify the helmet that best meets the needs of their specific workplace.

This standard outlines requirements for industrial head protection relating to:

1. Impact Protection
2. Penetration Protection
3. Electrical Insulation Protection

Three main changes to the ANSI/ISEA Z89.1-2014 standard were issued on May 15, 2014. (ANSI/ISEA Z89.1-2014 is the revision of the previous ANSI/ISEA Z89.1-2009) Manufacturers who want to claim any of these features can (1) test their helmets according to the new procedures, and (2) label their products appropriately:

1. Under the section of Accessories and Replacement Components there is further clarification that accessory or component manufacturers are required to prove that their components do not cause the helmets to fail. Helmet accessory or component suppliers must provide justification upon request that their product would not cause the helmet to fail the requirements of the Head Protection Standard.
2. Some additional language added under the Instructions and Markings section to help clarify that "useful service life" for helmets is not required by the Standard. It is up to helmet manufacturers if they want to include specific service life in terms of years. Manufacturers could elect to specify the number of years for their helmet's service life or elect to identify certain conditions that may affect a helmet's protection capability over time.
3. The last section revised was the Higher Temperature section for users who work in hot environments. This section was updated to incorporate an optional preconditioning at a higher temperature of 140° F ± 3.6° F (60° C ± 2° C). Previously hot temperature preconditioning was conducted at 120° F +/- 3.6° F (48.8° C ± 2° C) under the 2009 Standard. Helmets that meet the performance criteria after being preconditioned to these higher temperatures (140° F) will be designated with an "HT" marking.

Regulations and Standards for Head and Face Protection

Markings for Head Protection

According to the ANSI/ISEA standard, hard hats must also contain user information such as instructions pertaining to sizing, care and service life guidelines. Every hard hat conforming to the requirements of ANSI Z89.1-2014 must be appropriately marked to verify its compliance. The following information must be marked inside the hard hat:

- The manufacturer's name or identifying mark
- Date of Manufacture
- The legend, "ANSI Z89.1-2014"
- The Type and Class Designation
- The approximate head size range

If optional performance features are applicable, the appropriate marking(s) below must be applied in the sequence as shown:

-  - Reverse Donning
- LT - Lower Temperature
- HV - High Visibility
- HT - Higher Temperature

▲ WARNING

Hard hats are designed to provide limited protection to the head by reducing the force of falling objects striking the top of the hard hat shell. While limited protection is provided in other parts of the shell, this hard hat was not designed to provide front, side or rear impact protection. Avoid contact with electrical wires. NEVER ALTER OR MODIFY THE SHELL OR SUSPENSION SYSTEM. ALWAYS USE BULLARD REPLACEMENT PARTS.

Inspect your hard hat shell and suspension regularly. Check for cracks, frayed straps and any signs of damage before each use. Replace the hard hat immediately if you notice any signs of wear, damage, abuse or environmental degradation. If the hard hat has sustained a forcible blow (impact), dispose of it immediately, even if damage is not visible. Failure to follow these warnings could result in death or serious injury.

ANSI/ISEA Z87.1-2015 - Standard for Occupational and Educational Personal Eye and Face Protection

Bullard's industrial faceshields are all tested to ANSI/ISEA Z87.1-2015, the standard that sets forth criteria for the general requirements, testing, permanent marking, selection, care, and use of protectors to minimize the occurrence and severity or prevention of injuries from such hazards as impact, non-ionizing radiation, and chemical exposures in occupational and education environments including, but not limited to, machinery operations, material welding and cutting, chemical handling, and assembly operations. The standard provides the minimum requirements for protectors including selection, use, and maintenance of these protectors as devices to minimize or prevent eye and face injuries. The standard has tests for Optical Requirements, Physical Requirements, Lens Thickness (for non-impact rated faceshields), and Marking Requirements.

Bullard visors conform to ANSI/ISEA Z87.1-2015 standard when used in combination with Bullard approved headgear or faceshield brackets. See page 6 for classifications by model number.



Regulations and Standards for Face Protection

Bullard Brackets

Model	Description	Material	Standard	Fits Hard Hat Models									No Head Protection
				Cap Style				Full-Brim		Type II		Bump Cap	
				C30 911H	S61	S62	S51	C33/C34/ C35 911H	S71	Advent®	Vector		
300B	Dielectric, band mounting	Nylon	Z87/Z87+	x	x	x	x			x	x	x	
300BW	Dielectric, band mounting with neoprene gasket	Nylon	Z87/Z87+	x	x	x	x			x	x	x	
400	Dielectric, slot mounting	Nylon	Z87/Z87+	x	x	x	x						
400W	Dielectric, slot mounting with neoprene gasket	Nylon	Z87/Z87+	x	x	x	x						
312B	Dielectric, band mounting	Nylon	Z87/Z87+					x	x				
100G	Gold Line, band mounting	Aluminum	Z87/Z87+	x	x	x	x					x	
110G	Gold Line, band mounting for reverse orientation	Aluminum	Z87/Z87+	x	x	x	x						
112G	Gold Line, band mounting	Aluminum	Z87/Z87+					x	x				
500M	Gold Line, slot mounting	Aluminum	Z87/Z87+	x									
SENTINEL1	Headgear	ABS	Z87/Z87+										x
SENTINEL2	Headgear with chin protector	ABS	Z87/Z87+										x
ADFB	Accessory blades and hardware	ABS	Z87/Z87+							x	x		

Bullard Visors

Bullard Model	Material	Classification
640	Acetate	Z87 Non-impact Protector
640G	Acetate	Z87 Non-impact Protector
640PW3	Polycarbonate	Z87+ Impact Protector
640PW5	Polycarbonate	Z87+ Impact Protector
840M	Acetate	Z87 Non-impact Protector
840MH	Acetate	Z87 Non-impact Protector
840MX2	Acetate	Z87 Non-impact Protector
840MG	Acetate	Z87 Non-impact Protector
860H	Acetate	Z87 Non-impact Protector
CS40	Acetate	Z87 Non-impact Protector
1040	Acetate	Z87 Non-impact Protector
840ME	Polyester	Z87 Non-impact Protector
E840ME	Polyester	Z87 Non-impact Protector
680P	Polycarbonate	Z87+ Impact Protector
840P	Polycarbonate	Z87+ Impact Protector
840PW3	Polycarbonate	Z87+ Impact Protector
840PW5	Polycarbonate	Z87+ Impact Protector
840PX2	Polycarbonate	Z87+ Impact Protector
840PX2W3	Polycarbonate	Z87+ Impact Protector
840PX2W5	Polycarbonate	Z87+ Impact Protector
860P	Polycarbonate	Z87+ Impact Protector
880P	Polycarbonate	Z87+ Impact Protector
WS60PM	Polycarbonate	Z87+ Impact Protector
6S24	Mesh Screen	Z87 S Special Purpose
8S24	Mesh Screen	Z87 S Special Purpose
680T	Tritan	Z87+ Impact Protector
840T	Tritan	Z87+ Impact Protector
840TX2	Tritan	Z87+ Impact Protector
860T	Tritan	Z87+ Impact Protector
880T	Tritan	Z87+ Impact Protector
WS60TM	Tritan	Z87+ Impact Protector

Advanced Head Protection Advent® Helmet

The Advent® Helmet. Designed specifically for emergency response services.

The Advent® helmet offers paramedics, emergency medical technicians, industrial hazard response teams, and search and rescue personnel a revolutionary new concept in head protection. Available in two models, Advent® offers a variety of special benefits.

Highly Protective

Advent® offers top, front, side, and rear impact and penetration protection. This level of head protection is essential for emergency response professionals who are involved in everything from vehicle extrication to rope rescue. Advent® meets or exceeds all requirements of ANSI/ISEA Z89.1-2014, Type II, Class E & G.

Comfortable

At just over 25 ounces (709g), Advent® is half the weight of conventional firefighter helmets and is the same weight as many climbing helmets. Its compact design with no rear brim improves freedom of movement both in and out of emergency vehicles and confined spaces. A crown pad and a soft, replaceable, foam-backed vinyl brow pad provide extra comfort.

Easy Adjustment

The Advent® adjustable Sure-Lock® ratchet suspension (ADRTSL) makes it easy to size instantly.

Economical

Advent® is affordable. In fact, it's less than half the price of conventional fire helmets.

Adaptable

Advent® can be equipped with a variety of accessories, including faceshields, ear/neck protectors, and hearing protectors.

Easy to Customize

Advent® is designed as part of the professional's standard uniform. Both models are available in five colors and may be customized with pad printed logos, decals, and reflective stripes. Logos may be printed using up to six colors in as many as eight different locations.



Available Colors



Yellow
(YL)



Orange
(OR)



Red
(RD)



Blue
(BL)



White
(WH)



The Bullard three-rib design is a registered trademark of Bullard.

Advanced Head Protection - Advent® Helmet

Revolutionary Construction, Advanced Levels of Protection.

1. Tough Thermoplastic Outer Shell: Provides superior impact and penetration protection over a wide range of temperatures.
2. ABS and Foam Core Inner Shell: Protects by distributing forces of impact over a wide area.
3. 2- or 3-point Chinstrap with Quick-Release Buckle: Provides safety, versatility, and security.
4. Sure-Lock® Ratchet Headband: Offers quick adjustment and great fit.
5. 8-point Crown Strap System: Gives stability and comfort to the end-user.
6. Decals and Pad Printing: Customize your helmet with a Bullard decal on the front or sides. Pad printing is available in 8 locations.
7. Shell available in 5 colors.
8. Expanded Polystyrene Foam Core: Reduces the possibility of serious head injury by helping to absorb forces of impact.

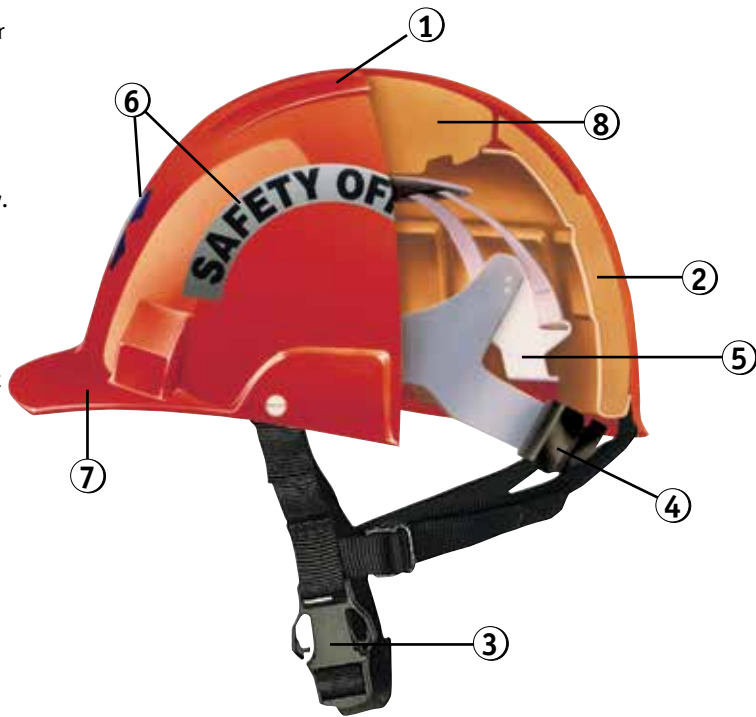

A1S

Advent® Helmet with 2-point Chinstrap

- Polycarbonate alloy shell
- Meets or exceeds ANSI/ISEA Z89.1-2014, Type II, Class E & G requirements
- ABS and EPS foam core impact liner
- Foam-backed vinyl crown pad and replaceable brow pad
- ABS inner shell
- 8-point Sure-Lock® ratchet suspension (ADRTSL)
- 2-point chinstrap with dielectric quick-release buckle (A110)
- Case quantity: 10; minimum order: 1



A1RDS

A2S

Advent® Helmet with 3-point Cradle Chinstrap

Same as Model A1 above with

- 3-point cradle chinstrap with dielectric quick-release buckle (A110)
- Case quantity: 10; minimum order: 1



A2BLS

Additional Accessories

pp. 11-13

Customization • Shell color chart • Part number

pp. 28-35

Advanced Head Protection Vector Helmet

The Vector Helmet. Designed to meet ANSI/ISEA and CSA Type II/2 Standards.

The Bullard Vector helmet provides impact protection for the top, front, back, and side of the head. Vector helmets are lightweight, comfortable, affordably priced, and designed to accommodate numerous accessories. In addition to the advanced features, the helmet is easy to customize with company logos, slogans, and reflective markings.

Protective

Vector helmets use a full inner shock liner to absorb impacts from the top, front, back, and side. The shock liner is carefully engineered to provide advanced protection with minimal weight. Combined with its heavy-duty polyethylene shell and optional self-sizing pinlock suspension or Flex-Gear® ratchet suspension, Vector offers advanced protection at a competitive price. A two-point chinstrap and heavy-duty polycarbonate faceshield are available as options.

Comfortable

Vector helmets offer lateral and top impact protection with only a slight weight addition over conventional hard hats. Either the self-sizing pinlock VT600 suspension or VTRT600 Flex-Gear® ratchet suspension ensures a secure and comfortable fit for virtually all head sizes and shapes. The standard Sportek brow pad is the most absorbent and comfortable brow pad available.

Economical

Vector helmets offer advanced head protection and comfort at an affordable price. The lightweight Vector helmets are compliant with ANSI/ISEA Z89.1-2014, Type II, Class E & G, and CSA Z94.1-2005, Type 2, Class E & G requirements. The Sportek brow pad, comfortable suspension, built-in goggle strap retaining slots, and Bullard's unsurpassed reputation for quality make Vector helmets a superior value in industrial head protection.

Easy to Customize

Vector helmets are available in eight standard shell colors and can be decorated with pad printed logos, decals, and reflective stripes. Logos may be printed using up to six colors in as many as eight different locations.



Available Colors

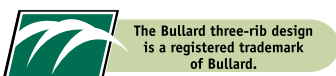
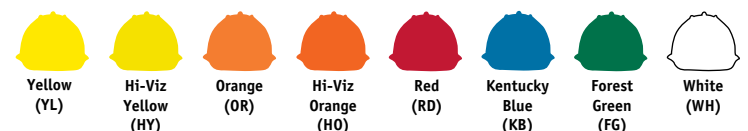

Advanced Head Protection - Vector Helmet

Advanced Levels of Protection

1. Outer Shell of Polyethylene
Lightweight design for maximum comfort.
2. Expanded Polystyrene Foam Core
Reduces the possibility of serious head injury by helping to absorb the forces of impact.
3. Four-point Suspension System
Straps are angled to fit the head for superior balance and comfort.
4. Ventilation Channels
Help keep wearer cooler.
5. Sizing Mechanism
Choose from either the Flex-Gear® ratchet or self-sizing pinlock suspension.

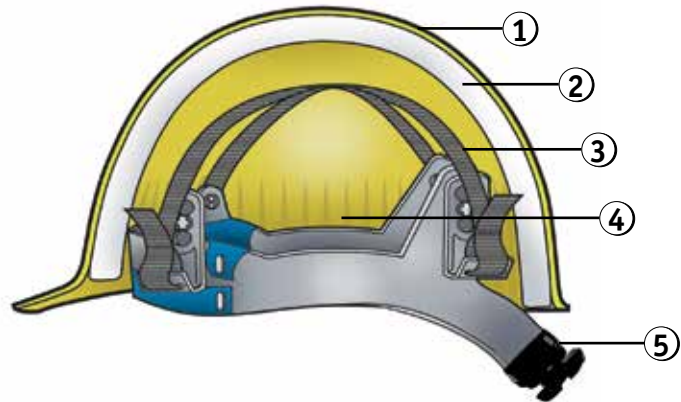

VTP

Helmet with Self-sizing pinlock suspension

- High-density polyethylene shell
- Meets or exceeds ANSI/ISEA Z89.1-2014, Type II, Class E & G and CSA Z94.1-2005, Type 2, Class E & G requirements
- EPS foam impact liner
- 4-point self-sizing pinlock suspension (VT600)
- Case quantity: 10; minimum order: 10



VTHYP

VTR

Helmet with Flex-Gear® Ratchet Suspension

- Same as Model Vector above with
- 4-point Flex-Gear® ratchet suspension (VTRT600)
- Case quantity: 10; minimum order: 10



VTKBR

Additional Accessories

pp. 11-13

Customization • Shell color chart • Part number

pp. 28-35

Advanced Head Protection

Advent® Replacement Parts and Accessories

- ADRTSL** Suspension for Advent®
- 8-point Sure-Lock® ratchet suspension
 - Foam-backed vinyl brow and crown pad (A101)



- A101** Brow Pad
- Foam-backed ventilated vinyl
 - For ADRTSL-Advent® suspension



VECTOR Replacement Parts and Accessories

- VT600** Suspension for Vector
- 4-point self-sizing pinlock suspension
 - Sportek brow pad (TT3)
 - Three vertical adjustments in front and rear



- VRT600** Suspension for Vector
- 4-point Flex-Gear® ratchet suspension
 - Sportek brow pad (TT3)
 - Three vertical adjustments in front and rear



- VTS** Foam Liner for Vector
- Expanded polystyrene (EPS) foam liner replacement



- TT3** Brow Pad
- Sportek replacement brow pad
 - For 4-point VT600, VTRT600 suspensions



Advanced Head Protection

Advent® and Vector Replacement Parts

-
- A110** Chinstrap for Advent® or Vector
- 2-point nylon chinstrap
 - Quick-release buckle



-
- ADFB** Accessory Blades
- For mounting 4" or 6" faceshield on Advent® or Vector
 - Includes blades and hardware
 - Faceshield must be purchased separately (R325 or R330)



-
- R325** Faceshield
- 6" faceshield
 - Optically correct polycarbonate faceshield
 - ADFB blades are required for assembly - sold separately



-
- R330** Faceshield
- 4" faceshield
 - Optically correct polycarbonate faceshield
 - ADFB blades are required for assembly - sold separately



-
- R160** Ratchet Cover
- Leather ratchet cover
 - For all Bullard ratchet suspensions



Advanced Head Protection

Customization for Advent® and Vector

OR145 3" (7.6 cm) Star of Life decal



Crescent Lettering Approx. 7" x 3" (1" wide)



OR308
Emergency Medical
Technician



OR309
Safety Officer



OR310
Paramedic



OR311
Rescue



OR315
Rescate



OR316
Paramedico



OR320
Ambulance

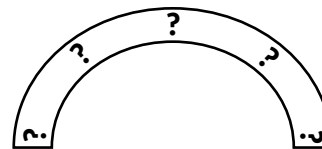

OR299
Custom

* For a complete listing of our Crescent Lettering selection, logon to BuildYourBullard.com



Classic Series Hard Hats and Caps

The Classic. The most comfortable hard hats and caps in the industry.

Featuring a wider profile than most hard hats, Classic caps and hats offer increased protection from rain, snow, dust, and harmful ultraviolet (UV) rays. With the Classic, you'll find a balanced fit with a comfortable six-point suspension.

Meets Safety Requirements

Models C30, C33, C34, C35, 911C, and 911H conform to all OSHA and ANSI/ISEA Z89.1-2014, Type I, Class E & G requirements, including impact, penetration, and electrical. Models C30 and C33 also conform to CSA Z94.1-2005, Type 1, Class E & G requirements.

Decoration

No other manufacturer offers more decorating flexibility and capability than Bullard. Bullard Logo Shop uses state-of-the-art technology to imprint your company logo or safety slogan in up to six colors in virtually any lateral position on the shell. No other manufacturer offers a decoration program that is as easy, fast, or reliable. Configure your Bullard Hard Hat on www.BuildYourBullard.com.

Worker visibility can be increased with Scotchlite® reflective stripes in a multitude of colors. Bullard offers a variety of shell colors and can match other colors for companies requiring specific shades.

Available Colors

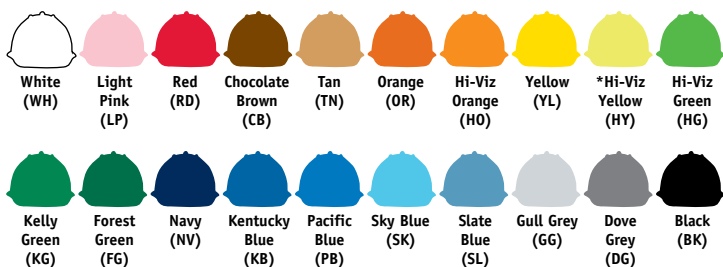

*Meets ANSI/ISEA Z89.1-2014 non-mandatory performance visibility requirements

Available Colors for 911 Series

The High Heat Hard Hats and Caps are available in a select number of colors.



The Bullard three-rib design is a registered trademark of Bullard.

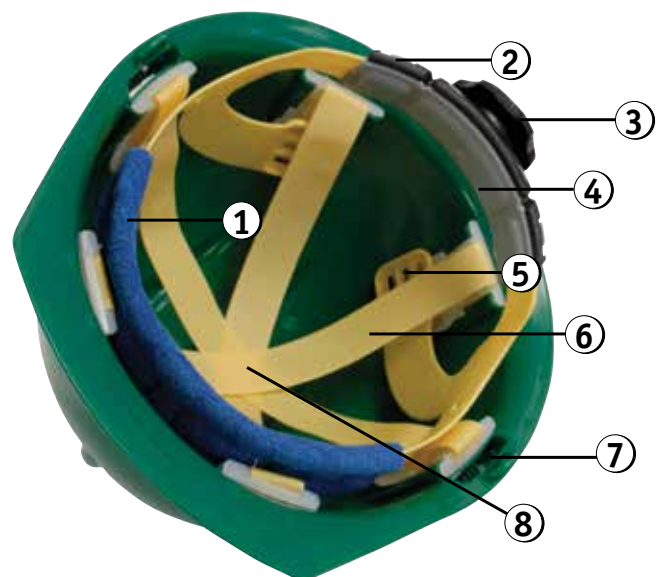

1. Pillowed Brow Pad in Vinyl, Cotton, or Polartec
2. Flex-Gear® Ratchet System
3. Ratchet Sizing Knob
4. Nape Cushion with Flex Points
5. Easy-to-Adjust Vertical Height Settings
6. Seamless 1" Nylon Crown Straps
7. Accessory Slots for Attachments
8. Six-point Balanced Suspension

Classic Series Hard Hats and Caps

C30 Model

- 30P** Classic Series Cap
- High-density polyethylene shell
 - Full-profile, wide-brim
 - Accessory slots for attachments
 - 6-point self-sizing pinlock suspension with large, absorbent cotton brow pad (RS6PC)
 - Replacement brow pads available (RBPCOTTON, RBPVINYL, RBPCOOL)
 - Meets or exceeds ANSI/ISEA Z89.1-2014, Type I, Class E & G and CSA Z94.1-2015, Type 1, Class E & G requirements
 - Case quantity: 20; minimum order: 20



30YLR

- 30R** Classic Series Cap
- Same as Model C30P above with
- 6-point Flex-Gear® ratchet suspension with large, absorbent cotton brow pad (RS6RC)
 - Replacement brow pads available (RBPCOTTON, RBPVINYL, RBPCOOL)
 - Case quantity: 20; minimum order: 20

C33 Model

- 33P** Classic Series Hat
- High-density polyethylene shell
 - Full-profile, full-brim
 - 6-point self-sizing pinlock suspension with large, absorbent cotton brow pad (RS6PC)
 - Replacement brow pads available (RBPCOTTON, RBPVINYL, RBPCOOL)
 - Meets or exceeds ANSI/ISEA Z89.1-2014, Type I, Class E & G requirements and CSA Z94.1-2015, Type 1, Class E & G requirements
 - Case quantity: 10; minimum order: 20



33KGR

- 33R** Classic Series Hat
- Same as Model C33P above with
- 6-point Flex-Gear® ratchet suspension with large, absorbent cotton brow pad (RS6RC)
 - Replacement brow pads available (RBPCOTTON, RBPVINYL, RBPCOOL)
 - Case quantity: 10; minimum order: 20

C34 Model

- 34P** Extra-Large Classic Series Hat
- High-density polyethylene shell
 - Extra-large, full-brim
 - 12% more interior space than the C33 model
 - 6-point self-sizing pinlock suspension with large, absorbent cotton brow pad (RS6PC)
 - Replacement brow pads available (RBPCOTTON, RBPVINYL, RBPCOOL)
 - Meets or exceeds ANSI/ISEA Z89.1-2014, Type I, Class E & G requirements
 - Case quantity: 10; minimum order: 20



34BKR

- 34R** Extra-Large Classic Series Hat
- Same as Model C34P above with
- 6-point Flex-Gear® ratchet suspension with large, absorbent cotton brow pad (RS6RC)
 - Replacement brow pads available (RBPCOTTON, RBPVINYL, RBPCOOL)
 - Case quantity: 10; minimum order: 20

Replacement Parts • Accessories

pp. 19-23

Customization • Shell color chart • Part number

pp. 28-35

Faceshield brackets • Visors

pp. 36-43

Classic Series Hard Hats and Caps

C35 Model

- 35P** Extra-Large Classic Series Hat
- High-density polyethylene shell
 - Extra-large, full-brim
 - 6-point self-sizing pinlock suspension with large, absorbent cotton brow pad (RS6PC)
 - Replacement brow pads available (RBPCOTTON, RBPVINYL, RBPCOOL)
 - Meets or exceeds ANSI/ISEA Z89.1-2014, Type I, Class E & G requirements and CSA Z94.1-2005, Type 1, Class E & G requirements
 - Case quantity: 10; minimum order: 20

COMING SOON



- 35R** Extra-Large Classic Series Hat
- Same as Model C35P above with
- 6-point Flex-Gear® ratchet suspension with large, absorbent cotton brow pad (RS6RC)
 - Replacement brow pads available (RBPCOTTON, RBPVINYL, RBPCOOL)
 - Case quantity: 10; minimum order: 20

Classic Series High Heat Hard Hats and Caps

To meet the demands of high heat environments, Bullard produces hats and caps in technologically advanced thermoplastic materials. Constructed from the same materials as our rugged Wildland firefighter helmets, Bullard Models 911C and 911H are ideal for utilities, welding, foundries, and steel mills. Models 911C and 911H Helmets meet or exceed ANSI/ISEA Z89.1-2014, Type I, Class E & G requirements.

911 Series

- 9CP** High Heat Cap
- High-heat resistant thermoplastic outer shell
 - 6-point self-sizing pinlock suspension (FRS6PC)
 - Cotton brow pad (RBPCOTTON)
 - Meets or exceeds ANSI/ISEA Z89.1-2014, Type I, Class E & G requirements
 - Case quantity: 20; minimum order: 10

- 9CR** High Heat Cap
- Same as Model 911C above with
- 6-point Sure-Lock® ratchet suspension (FRS6RC)
 - Cotton brow pad (RBPCOTTON)
 - Case quantity: 20; minimum order: 10



9CYLR

911 Series Cap with Sure-Lock® Ratchet Suspension

- 9HP** High Heat Hat
- High-heat resistant thermoplastic outer shell
 - Full-brim model
 - 6-point self-sizing pinlock suspension (FRS6PC)
 - Cotton brow pad (RBPCOTTON)
 - Meets or exceeds ANSI/ISEA Z89.1-2014, Type I, Class E & G requirements
 - Case quantity: 10; minimum order: 10

- 9HR** High Heat Hat
- Same as Model 911H above with
- 6-point Sure-Lock ratchet suspension (FRS6RC)
 - Cotton brow pad (RBPCOTTON)
 - Case quantity: 10; minimum order: 10



9HBLR

911 Series Cap with Sure-Lock® Ratchet Suspension

Replacement Parts • Accessories

pp. 19-23

Customization • Shell color chart • Part number

pp. 28-35

Faceshield brackets • Visors

pp. 36-43



Standard Series Hard Hats and Caps

The Standard. Takes style and versatility to a new level.

The low profile shell design of the Standard cap combines a perfect fit with a look workers prefer. The sleek, trim shell profile is the most stylish in the industry.

Meets Safety Requirements

Bullard Models S51, S61, and S71 conform to all ANSI/ISEA Z89.1-2014, Type I, Class E & G requirements, including impact, penetration, and electrical insulation. Bullard Model S62 (vented) conforms to all ANSI/ISEA Z89.1-2014, Type I, Class C requirements, including impact and penetration. Model S51 conforms not only to ANSI/ISEA Z89.1-2014, Type I, Class E & G requirements but also to CSA Z94.1-2005, Type 1, Class E & G and EN397: 2012, Type 1, Class E & G requirements.

Decoration

Bullard Logo Shop uses state-of-the-art technology to imprint your company's logo or safety slogan. Whether the design is one color or six, it can be reproduced accurately, quickly, and inexpensively. No other manufacturer offers a decoration program that is as easy, fast, or reliable. Configure your Bullard Hard Hat on www.BuildYourBullard.com.

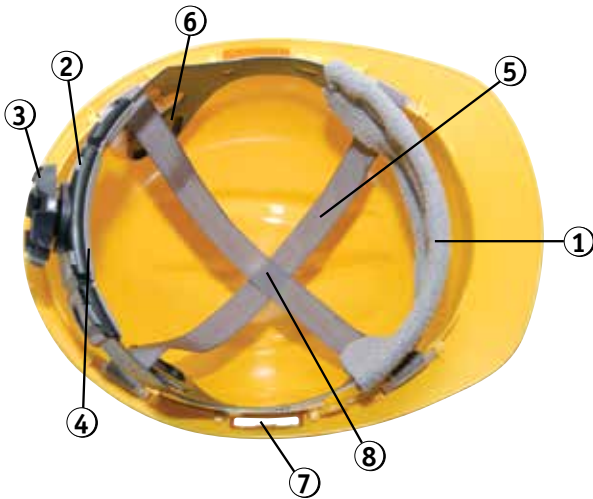

1. Pillowed Brow Pad in Vinyl, Cotton, Polyester, or Polartec
2. Flex-Gear® Ratchet System
3. Ratchet Sizing Knob
4. Nape Cushion with Flex Points
5. Seamless 3/4" Nylon Crown Straps
6. Easy to Adjust Vertical Height Settings
7. Accessory Slots for Attachments
8. Four-point Balanced Suspension

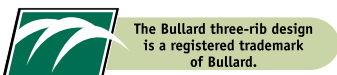

Available Colors

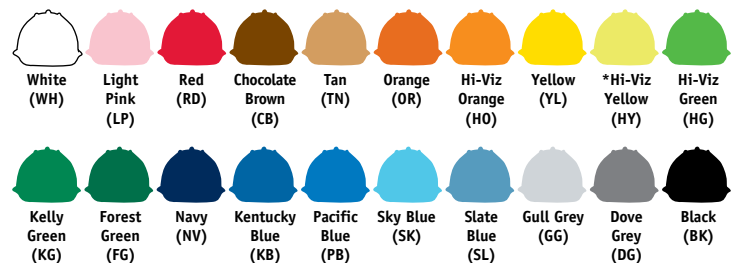

*Meets ANSI/ISEA Z89.1-2014 non-mandatory performance visibility requirements

Standard Series Hard Hats and Caps

Model S51

- 51P** Standard Series Cap
- High-density, polyethylene shell with flat front, low-profile design
 - Accessory slots for attachments
 - Rain trough brim
 - 4-point self-sizing pinlock suspension with poly (RS4PP) or vinyl (RS4PV) brow pad
 - Replacement brow pads available (RBPCOTTON, RBPVINYL, RBPCOOL)
 - Meets or exceeds ANSI/ISEA Z89.1-2014, Type I, Class E & G and CSA Z94.1-2005, Type 1, Class E & G requirements, & EN397:2012
 - Case quantity: 20; minimum order: 20



- 51R** Standard Series Cap
Same as Model S51P above with
- 4-point Flex-Gear® ratchet suspension with poly (RS4RP) or vinyl (RS4RB) brow pad

Model S61

- 61P** Standard Series Cap
- High-density, polyethylene shell with rounded front, low-profile design
 - Accessory slots for attachments
 - 4-point self-sizing pinlock suspension with large, absorbent cotton (RS4PC) or vinyl (RS4PV) brow pad
 - Replacement brow pads available (RBPCOTTON, RBPVINYL, RBPCOOL)
 - Meets or exceeds ANSI/ISEA Z89.1-2014, Type I, Class E & G requirements
 - Case quantity: 20; minimum order: 20



- 61R** Standard Series Cap
Same as Model S61P above with
- 4-point Flex-Gear® ratchet suspension with large, absorbent cotton (RS4RC) or vinyl brow pad (RS4RB)

Model S62

- 62P** Standard Series Cap
- Vented shell
 - High-density, polyethylene shell with rounded front, low-profile design
 - Accessory slots for attachments
 - 4-point self-sizing pinlock suspension with large, absorbent cotton (RS4PC) or vinyl (RS4PV) brow pad
 - Replacement brow pads available (RBPCOTTON, RBPVINYL, RBPCOOL)
 - Meets or exceeds ANSI/ISEA Z89.1-2014, Type I, Class C requirements
 - Case quantity: 20; minimum order: 20



- 62R** Standard Series Cap
Same as Model S62P above with
- 4-point Flex-Gear® ratchet suspension with large, absorbent cotton (RS4RC) or vinyl (RS4RB) brow pad

Model S71

- 71P** Standard Series Hat
- High-density, polyethylene shell with a full-brim, low-profile design
 - 4-point self-sizing pinlock suspension with large, absorbent cotton (RS4PC) or vinyl (RS4PV) brow pad
 - Replacement brow pads available (RBPCOTTON, RBPVINYL, RBPCOOL)
 - Meets or exceeds ANSI/ISEA Z89.1-2014, Type I, Class E & G requirements
 - Case quantity: 10; minimum order: 20



- 71R** Standard Series Hat
Same as Model S71P above with
- 4-point Flex-Gear® ratchet suspension with large, absorbent cotton (RS4RC) or vinyl (RS4RB) brow pad

Replacement Parts • Accessories	pp. 19-23
Customization • Shell color chart • Part number	pp. 28-35
Faceshield brackets • Visors	pp. 36-43

Classic and Standard Series Hard Hats and Caps

Classic Series Replacement Parts and Accessories

Replacement Suspensions for Models C30, C33, C34 and C35

RS6PC

- 6-point self-sizing pinlock suspension
- Large, absorbent cotton brow pad
- Replacement brow pads available (RBPCOTTON, RBPVINYL, RBPCOOL)
- Vertical height adjustments (two front, three rear)
- For Models C30, C33, C34 and C35



RS6RC

- 6-point Flex-Gear® ratchet suspension
- Large, absorbent cotton brow pad
- Replacement brow pads available (RBPCOTTON, RBPVINYL, RBPCOOL)
- Flex-points and nape cushion
- Large, easy-to-turn ratchet knob
- Vertical height adjustments (two front, three rear)
- For Models C30, C33, C34 and C35



Replacement Suspensions 911 Series Hard Hats

FRS6PC

- Same features as RS6PC
- For Models 911C and 911H



FRS6RC

- Same features as RS6RC, but with Sure-Lock® Ratchet
- For Models 911C and 911H



Q: How do I determine the model number of my hard hat?

A: It's easy. Look under the brim of the hat or cap; the model number is molded right into the brim.



Classic and Standard Series Hard Hats and Caps

Standard Series Replacement Parts and Accessories

Replacement Suspensions for Models S51, S61, S62, and S71

RS4PC

4-pt. Suspension

- 4-point self-sizing pinlock suspension
- Large absorbent cotton brow pad
- Replacement brow pads available (RBPCOTTON, RBPVINYL, RBPCOOL)
- Vertical height adjustments (two front, two rear)
- For Models S51, S61, S62, and S71



RS4RC

4-pt. Suspension

- 4-point Flex-Gear® ratchet suspension
- Large absorbent cotton brow pad
- Replacement brow pads available (RBPCOTTON, RBPVINYL, RBPCOOL)
- Flex-points and nape cushion
- Large, easy-to-turn ratchet knob
- For Models S51, S61, S62, and S71



RS4PP

4-pt. Suspension

- 4-point self-sizing pinlock suspension
- Large poly brow pad
- Replacement brow pads available (RBPCOTTON, RBPVINYL, RBPCOOL)
- Vertical height adjustments (two front, two rear)
- For Models S51, S61, S62, and S71



RS4RP

4-pt. Suspension

- 4-point Flex-Gear® ratchet suspension
- Large poly brow pad
- Replacement brow pads available (RBPCOTTON, RBPVINYL, RBPCOOL)
- Flex-points and nape cushion
- Large, easy-to-turn ratchet knob
- For Models S51, S61, S62, and S71

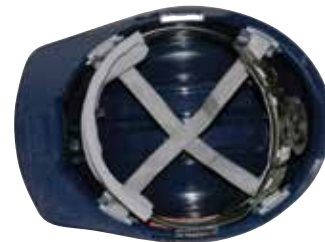

RS4PV

4-pt. Suspension

- 4-point self-sizing pinlock suspension
- Large vinyl brow pad
- Replacement brow pads available (RBPCOTTON, RBPVINYL, RBPCOOL)
- Vertical height adjustments (two front, two rear)
- For Models S51, S61, S62, and S71



RS4RB

4-pt. Suspension

- 4-point Flex-Gear® ratchet suspension
- Large vinyl brow pad
- Replacement brow pads available (RBPCOTTON, RBPVINYL, RBPCOOL)
- Flex-points and nape cushion
- Large, easy-to-turn ratchet knob
- For Models S51, S61, S62, and S71



Classic and Standard Series Hard Hats and Caps

Classic and Standard Series Replacement Parts and Accessories

NEW

EARMUFFSM

Hearing Protection

- Slot Mounted
- Noise Reduction Rating (NRR) of 28db
- Meets OSHA Requirement for NRR
- Light weight soft foam cushion pads for all day comfort
- Fits Bullard cap models C30, S51, S61 and S62



RBPCOTTON

Brow Pad

- Large, absorbent cotton replacement brow pad
- Fits all Bullard suspensions
- Easy, Velcro® design



RBPVINYL

Brow Pad

- Vinyl replacement brow pad
- Fits all Bullard suspensions
- Easy, Velcro® design



RBPCOOL

Brow Pad

- Polartec replacement brow pad
- Wicking material moves sweat away from the worker's brow
- Fits all Bullard suspensions
- Easy, Velcro® design



R160

Ratchet Cover

- Leather ratchet cover
- Fits all Bullard ratchet suspensions



Classic and Standard Series Hard Hats and Caps

Classic and Standard Series Replacement Parts and Accessories

ES42 2-Point Elastic Chinstrap, Natural

- Latex-free, natural elastic
- For Models S51, S61, S62, S71, C30, C33, C34, C35, 911C, 911H, and Bump Cap



ES42B 2-Point Elastic Chinstrap, Black

- Latex-free, black elastic
- For Models S51, S61, S62, S71, C30, C33, C34, C35, 911C, 911H, and Bump Cap



ES3 3-Point Elastic Chinstrap, Black

- Latex-free, black elastic
- For Models S61, S62



R50 2-Point Nomex® Chinstrap, black

- Nomex chinstrap with postman's slide fastener
- For Models S51, S61, S62, S71, C30, C33, C34, C35, 911C, 911H, and Bump Cap



GC100 Goggle Clips

- Self-adhesive
- Set of three



30013 Slot Plugs

- Flexible plugs for hard hat accessory slots
- Set of two
- For Models C30, C35, S51, S61 and S62



Classic and Standard Series Hot Weather and UV Accessories

Bullard offers hard hat wearers a variety of inexpensive accessories that help block the sun's dangerous ultraviolet rays, keep workers cool, and enhance their productivity on the job. While Bullard hard hats and caps shade the worker's head from direct sunlight, these accessories provide added protection from the discomforts associated with overexposure to the sun.

CSS

Cotton Sunshade

- 100% cotton sunshade
- For all helmets, hard hats, and caps
- Protects neck from sun exposure and UV radiation
- Attaches with three Velcro® strips that are provided
- Hard hat not included



SS5

Sun Shield

- "See through" front for overhead visibility
- Extends hat brim 360 degrees to protect face, neck, and ears from sun exposure
- Fits Models S51, S61, S62, C30, and 911C
- Hard hat not included



SS6

Sun Shield

- Same as Model SS5 above
- Fits Models S71, C33, C34, C35 and 911H
- Hard hat not included



UBG

Under brim Anti-Glare Decal

- Reduces glare
- For all helmets, hard hats, and caps
- Hard hat not included



ECB

Evaporative Cooling Beanie

- Submerge in water for 1-2 minutes
- Fits all hard hats and caps
- Hard hat not included



ECCN

Evaporative Cooling Crown and Neck Shade

- Submerge in water for 1-2 minutes
- Fits all hard hats and caps
- Hard hat not included



Faceshield brackets • Visors
Other personal cooling options

pp. 36-43
pp. 44-45



Bump Caps

The Bump Cap. Combines comfort and protection with style.

Designed for industries such as meat and food processing, utility meter reading, pest control, fruit harvesting, and auto repair, Bump Cap (BC) and First Base® (FB) models offer a variety of user options. Bullard bump caps provide limited protection against minor bumps and abrasions and are not designed for applications requiring ANSI approved head protection.

Bullard Bump Cap

The Bullard Bump Cap offers wearers a sleek style combined with user comfort and maximum versatility to provide the ultimate protection against minor bumps, bruises, and lacerations. Equipped with a technologically advanced double-hoop design for greater reinforcement and durability along with an easy-to-assemble user replaceable suspension, the Bullard Bump Cap offers unmatched comfort with a secure fit. Bullard Bump Caps may be customized with pad printed logos using up to six colors in as many as four different locations.

First Base®

The First Base bump cap combines comfort and protection for the wearer in the style of a baseball cap. It has a lightweight design and benefits in strength and protection from a low-density polyethylene liner. An inner foam pad is also included to provide all-day user comfort. The simple one-size-fits-all adjustment ensures a superior fit for all workers.

This cap comes standard with six eyelet holes for superior ventilation. Monogramming is available for a fully customized look.

Available Bump Cap (BC) Colors

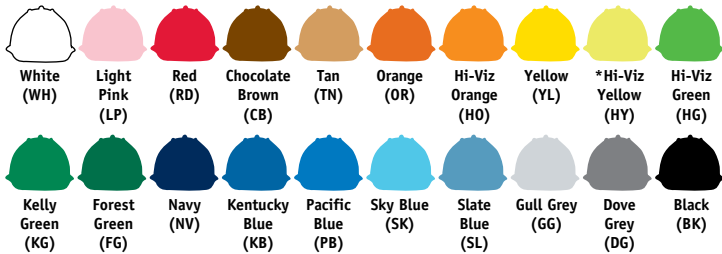

*Meets ANSI/ISEA Z89.1-2014 non-mandatory performance visibility requirements

Available First Base (FB) Colors

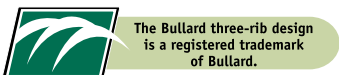

Bump Caps

Bullard Bump Cap

- BCV** Bullard Bump Cap
- Double-hoop design for greater durability
 - 4-point adjustable suspension system with vinyl brow pad (BCHBV)
 - Accommodates the widest array of head sizes of any bump cap on the market ranging from 6 ³/₈" to 8 ¹/₄"
 - Compatible with Bullard Brackets 100G, 300B, and 300BW
 - Compatible with all Bullard visors
 - Case quantity: 25; minimum order: 25



BCKGP

- BCP** Bullard Bump Cap
- Same as BCV
 - 4-point adjustable suspension system with poly brow pad (BCHBP)

Bullard Bump Cap Replacement Parts and Accessories

Replacement Suspensions

- BCHBV** Replacement Suspension with Vinyl Brow Pad (shown)
- BCHBP** Replacement Suspension with Poly Brow Pad

Replacement Brow Pads

- BCRBPV** Replacement Vinyl Brow Pad
- BCRBPP** Replacement Poly Brow Pad



BCHBV

-
- ES42** 2-Point Elastic Chinstrap, Natural
- Latex-free, natural elastic
 - For Models S51, S61, S62, S71, C30, C33, C34, C35, 911C, 911H, and Bump Cap



-
- ES42B** 2-Point Elastic Chinstrap, Black
- Latex-free, black elastic
 - For Models S51, S61, S62, S71, C30, C33, C34, C35, 911C, 911H, and Bump Cap



Bump Caps

First Base®

FB2000

Ventilated Cap

- Six sewn eyelet holes
- Low-density polyethylene liner
- Includes foam pad



Available in seven colors:



First Base Replacement Parts

FBINSHELL

Inner Liner

- Low-density polyethylene
- Includes foam pad
- Fits most baseball style caps



FBFOAM

Foam Pad for First Base Bump Cap



Custom Embroidery Available

- 24-piece minimum on custom embroidered caps
- Logos can be embroidered on front of cap
- Embroidered sample provided for approval
- One time digitization fee on initial order
- contact Customer Service for details



Industrial Head Protection Replacement Parts and Accessories

Bullard Hard Hat Replacement Parts and Accessories Guide

Part Number	Description	C30	S51	S61/ S62	911C	C33/ C34	C35	S71	911H	Advent®	Vector	Bump Cap
Replacement Suspensions												
RS6PC	Replacement Suspension, 6pt, Pinlock, Cotton Brow Pad	X				X	X					
RS6RC	Replacement Suspension, 6pt, Ratchet, Cotton Brow Pad	X				X	X					
RS4PP	Replacement Suspension, 4pt, Pinlock, Poly Brow Pad		X	X				X				
RS4PC	Replacement Suspension, 4pt, Pinlock, Cotton Brow Pad		X	X				X				
RS4PV	Replacement Suspension, 4pt, Pinlock, Vinyl Brow Pad		X	X				X				
RS4RP	Replacement Suspension, 4pt, Ratchet, Poly Brow Pad		X	X				X				
RS4RC	Replacement Suspension, 4pt, Ratchet, Cotton Brow Pad		X	X				X				
RS4RB	Replacement Suspension, 4pt, Ratchet, Vinyl Brow Pad		X	X				X				
FRS6PC	Replacement Suspension, 6pt, Pinlock, Cotton Brow Pad				X				X			
FRS6RC	Replacement Suspension, 6pt, Ratchet, Cotton Brow Pad				X				X			
ADRTSL	Replacement Suspension, 8pt, Ratchet, Vinyl Brow Pad									X		
VT600	Replacement Suspension, 4pt, Pinlock, Sportek Brow Pad										X	
VRT600	Replacement Suspension, 4pt, Ratchet, Sportek Brow Pad										X	
BCHBV	Replacement Suspension with Vinyl Brow Pad											X
BCHBP	Replacement Suspension with Poly Brow Pad											X
Accessories and Replacement Parts												
ES42	Chinstrap, 2-point, latex-free elastic, natural	X	X	X	X	X	X	X	X	X	X	X
ADH20	Miner Lamp Bracket kit		X				X					
ES42B	Chinstrap, 2-point, latex-free elastic, black	X	X	X	X	X	X	X	X	X	X	X
GC100	Goggle Clips, self-adhesive	X	X	X	X	X	X	X	X	X	X	X
R160	Ratchet Cover, leather	X	X	X	X	X	X	X	X	X	X	
R50	Chinstrap, 2-point, Nomex® with postman's slide, black	X	X	X	X	X	X	X	X			
RBPCOTTON	Cotton Replacement Brow Pad	X	X	X	X	X	X	X	X			
RBPVINYL	Vinyl Replacement Brow Pad	X	X	X	X	X	X	X	X			
RBPCOOL	Polartec Replacement Brow Pad	X	X	X	X	X	X	X	X			
30013	Accessory Slot Plugs	X	X	X			X	X				
ES3	Chinstrap, 3-point, latex-free elastic with chin cup, black			X								
EARMUFFSM	Hearing Protection	X	X	X								
A110	Chinstrap, 2-point, nylon, black								X		X	
A101	Vinyl Replacement Brow Pad								X			
TT3	Sportek Replacement Brow Pad										X	
BCRBPV	Vinyl Replacement Brow Pad											X
BCRBPP	Poly Replacement Brow Pad											X
Hot Weather and UV Accessories												
UBG	Under brim Anti-Glare Decal	X	X	X	X	X	X	X	X	X	X	X
ECB	Evaporative Cooling Beanie	X	X	X	X	X	X	X	X	X	X	X
ECCN	Evaporative Cooling Crown and Neck Shade	X	X	X	X	X	X	X	X	X	X	X
CSS	Cotton Neck Sunshade	X	X	X	X	X	X	X	X			X
SS5	Sun Shield	X	X	X								
SS6	Sun Shield					X	X	X	X			



Bullard[®] LOGO SHOP



Customizing your hard hat has never been easier on **Build Your Bullard!**

The hard hat is one of the most recognized pieces of safety equipment on any work site. Take advantage of this opportunity to advertise company products or services, improve worker visibility, and identify worker differentiation. Whether you supply camera-ready artwork or your logo on a business card or letterhead, Bullard will create a hard hat that comes alive to promote your organization's unique identity.



Quality Printing

Pad printed logos are permanent and will not peel, crack, or fade like a decal or sticker.

Order Size

Twenty piece minimum order required for custom logo work.

Pricing

No hidden charges. No set-up charges. No artwork charges.

Delivery

Bullard Logo Shop offers the fastest delivery in the industry.

Pad printed logos are permanent and will not peel, crack, or fade like a decal or sticker. Bullard uses the latest technology available to print clear, crisp logos in up to six different colors per logo - up to eight different locations around the cap - on any Bullard helmet, hat, or cap. We also offer a variety of Scotchlite[®] striping options in various colors and reflectivity. Stripes can be applied around the brim or between the ribs of the hat. Decorative stripe colors are available to accent your custom logo, or use fluorescent and highly reflective stripes to improve worker visibility.

Build Your Bullard lets you customize your hard hat quickly and easily. Just logon to www.BuildYourBullard.com to configure your hat.





Advanced Series
A1, A2, VT



Classic Series
30, 33, 34, 35



Standard Series
51, 61, 62, 71



Classic Series High Heat
9C, 9H



Bump Caps
BC

STANDARD COLORS	Abbreviation	PMS Color	ADVENT® A1, A2	VECTOR VT	Classic 30, 33, 34, 35, BC	STANDARD 51, 61, 62, 71	HIGH HEAT 9C, 9H
White	WH	n/a	•	•	•	•	•
Light Pink	LP	1895C			•	•	
Red	RD	186C	•	•	•	•	•
Chocolate Brown	CB	469			•	•	
Tan	TN	729C			•	•	
Orange	OR	173C	•	•	•	•	•
Hi-Viz Orange	HO	021C		•	•	•	
Yellow	YL	109C	•	•	•	•	•
Hi-Viz Yellow	HY	387C		•	•	•	
Hi-Viz Green	HG	361C			•	•	
Kelly Green	KG	348C			•	•	
Forest Green	FG	3425C		•	•	•	
Navy	NB	289C			•	•	
Kentucky Blue	KB	301U	•	•	•	•	•
Pacific Blue	PB	300C			•	•	
Sky Blue	SK	2985C			•	•	
Slate Blue	SL	549C			•	•	
Gull Grey	GG	428C			•	•	
Dove Grey	DG	424C			•	•	
Black	BK	n/a			•	•	

- - Cap/hat available in this color at a standard four business day lead time. Special colors available: 500-piece minimum. Contact the Bullard Customer Service Department for pricing and lead time. Must furnish PMS number or color match sample.

Follow these steps for simple and easy hard hat ordering

- 1 Start with the hard hat model number 2-digit code (listed above).
2. Add the 2-letter color code (listed above).
3. Add one letter for your choice of the suspension (listed below).
4. If you have a custom pad printed hard hat, you may include the **Build Your Bullard** (BYB) project number at the end of the part number for convenient ordering.

Example:

Model # + Color + Suspension = Part Number Model # + Color + Suspension + Logo = Part Number
 30 RD R 30RDR 61 YL P BYB12345 61YLPBYB12345

Choose your hard hat suspension

Abbreviation	Hard Hat Models
S (Standard)	A1, A2
R (Ratchet)	VT, 30, 33, 34, 35, 51, 61, 62, 71
P (Pinlock)	VT, 30, 33, 34, 35, 51, 61, 62, 71, BC
B (Ratchet, Vinyl)	51, 61, 62, 71
V (Pinlock, Vinyl)	51, 61, 62, 71, BC



Hard Hat Colors

Brilliant Headgear

In choosing a color, it is important to consider the work surroundings. Available in hi-viz orange, yellow, and green, you can select the most appropriate contrasting color for the job site to ensure workers get noticed. These true fluorescent colors are visible under a black light and provide the greatest visible color impact. Bullard's *Hi-Viz Yellow passes ANSI/ISEA Z89.1-2014 non-mandatory high-visibility standard.

Hard Hat Color Selection

Bullard offers 20 of the most popular standard colors for our high-density polyethylene hats and caps. Our wide selection of colors is sure to meet your company's needs. Special colors are available upon request. Minimal volumes apply.

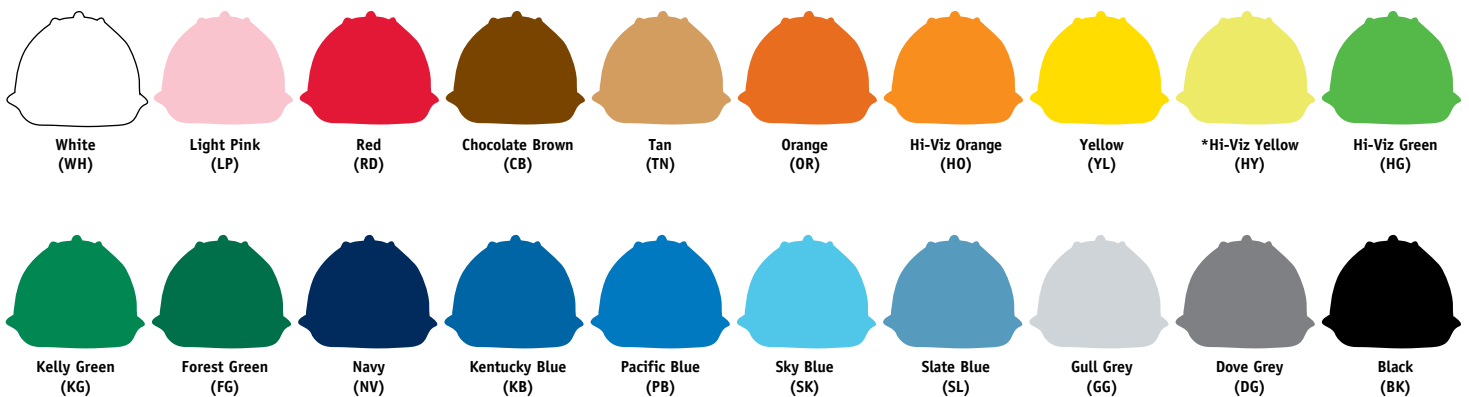

Decoration for Hard Hats and Caps

Logo Size Chart (by hat model)

Hat/Cap Model	Dimensions			Maximum Size			
				Front	Side	Back	
S51	Width (length)			2 1/8"	4"	2 3/4"	
	Height			2 3/4"	1 3/4"	2 1/2"	
S61, S62	Width (length)			2 1/4"	3 1/4"	2"	
	Height			2"	1 1/2"	2"	
S71	Width (length)			2"	3 3/4"	2 3/4"	
	Height			2"	1 3/4"	1 3/4"	
C30, C33, C34, C35 911C, 911H	Width (length)			2 3/4"	4"	2 3/4"	
	Height			2 1/2"	1 3/4"	2 1/2"	
Advent® A1, A2, Vector	Width (length)			3"	4"	3"	
	Height			3"	1 3/4"	3"	
BC	Width (length)	3"	2 1/2"	1 1/2"	1 1/2"	2"	1 1/4"
	Height						

Models S61, S62, and S71 have a low profile with more curvature, which may require that some logos be printed smaller than listed above. Bullard will print all logos to maximum size allowed based on the logo design and shape, unless otherwise specified. Bullard must receive artwork before exact logo size can be determined.

Note: The size may vary on square or rectangular logos.





Follow these simple steps to configure YOUR Bullard Hard Hat or Bump Cap

1. Go to www.BuildYourBullard.com
2. Select Head and Face Protection and your desired model
3. Register and Sign In to request a proof
4. Build your custom hat with your logo!



Camera Ready vs. Non-Camera Ready

Example of Camera Ready Artwork:



Example of Non-Camera Ready Artwork:



Camera Ready Means...

- Faster proof turn around time in just three (3) business days
- Precise logo reproduction

Typical Camera Ready art file extensions include:

- .eps (Vector EPS)
- .pdf (Vector PDF)
- .ai (Illustrator)
- .fh (Freehand)
- .cdr (Corell Draw)

Non-Camera Ready Means...

- Longer proof turn around time (5-7 business days)
- Must supply Pantone® colors

Typical Non-Camera Ready art file extensions include:

- .tiff (Tag Image File Format)
- .jpg, .jpeg (Joint Photographic Experts Group)
- .pdf (Raster PDF)
- .png (Portable Network Graphics)

Mixing Cap Colors or Models on an Order

- Colors: A minimum order of 20 pieces is required per cap/hat color. Colors can be mixed (with a minimum of 20 per color) to meet a higher quantity logo price break, providing that the logo and configuration remain the same.
- Models: Cap and hat models cannot be mixed to meet a logo price break.

Logo Archiving

Bullard will archive logos for up to 24 months. If a logo has not been used within two years, we request that new artwork be submitted and a new proof approved.

Tips for getting camera-ready artwork:

1. Ask your customer for vector or line art or the original art used to print business cards, signs, letterhead, etc.
2. Ask for art that has been converted to points and paths and includes any embedded files.
3. Remember that, in most cases, neither you nor your customer may be able to open the file. That's usually the file we need.

Decoration for Hard Hats and Caps

Stock Logos

If you don't have your own artwork to use on your decorated Bullard hard hat, you might find something in our selection of stock logos.

Stock Logos Available:



PP290

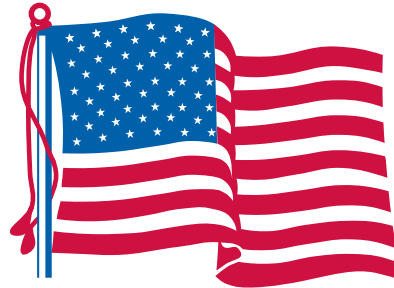

THINK SAFETY

PP24689

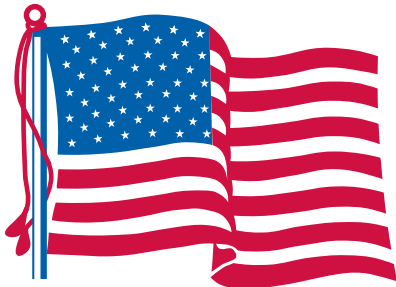

PP6460

VISITOR

PP5009



PP24870

*Safety
depends on
You!*

PP6122



Reflective Striping

Reflective Stripes for Classic and Standard Series Hats and Caps

Single color reflective Scotchlite® brand stripes are available for improved visibility and work group identification. Bullard offers striping in two locations - around the brim and between the ribs (two stripes) of the hat.

To receive stripe pricing and delivery for multi-colored stripes or special requirements, please contact Bullard Customer Service. An application fee will apply (per hat) if Bullard applies the striping.



Striping Options for Classic Series

Factory Applied Part # Code

Around the Brim 1 1/16" wide x 23" long

ST1R500	Highly Reflective Silver Stripe, 500 CPL	S5
ST1RORG175	Fluorescent Orange Stripe, 175 CPL	O7
ST1RBLU	Blue Reflective Strip, 10 CPL	B1
ST1RGRN	Green Reflective Stripe, 15 CPL	G1
ST1RORG	Orange Reflective Stripe, 25 CPL	O1
ST1RRER	Red Reflective Stripe, 20 CPL	R1
ST1RWHT	White Reflective Stripe, 100 CPL	W1
ST1RYLW	Lime-Yellow Reflective Stripe, 60 CPL	Y2



Model C30 with ST1R00 stripe 30YLRRS5

Between the Ribs 3/4" wide x 20" long

ST2RBLU	Blue Reflective Stripe, 10 CPL	B2
ST2RGRN	Green Reflective Stripe, 15 CPL	G2
ST2RORG	Orange Reflective Stripe, 25 CPL	O2
ST2RRER	Red Reflective Stripe, 20 CPL	R2
ST2RWHT	White Reflective Stripe, 100 CPL	W2
ST2RYLW	Lime-Yellow Reflective Stripe, 60 CPL	Y2



Model C30 with ST2RWHT stripe 30WHRW2

Striping Options for Standard Series

Around the Brim 1" wide x 21 1/2" long

STRSS500	Highly Reflective Silver Stripe, 500 CPL	I5
STRSSORG175	Fluorescent Orange Stripe, 175 CPL	O10
STRSSBLU	Blue Reflective Stripe, 10 CPL	SB
STRSSGRN	Green Reflective Stripe, 15 CPL	SG
STRSSORG	Orange Reflective Stripe, 25 CPL	SO
STRSSRED	Red Reflective Stripe, 20 CPL	SR
STRSSWHT	White Reflective Stripe, 100 CPL	SW
STRSSYLW	Lime-Yellow Reflective Stripe, 60 CPL	S4



Model S71 with ST2RWHT stripe 71YLRSW

Standard Stripe Colors for ST1R, ST2R, and STRSS



Striping Options for Classic Series and Standard Series Factory Applied
Part # Code

Three piece Around the Brim 1" wide x 4" long

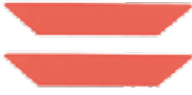
R538	Retro-Reflective 500 CPL White ScotchLite® Stripes	R8		R541
R540	Retro-Reflective 175 CPL Lime-Yellow ScotchLite Stripes	R6		
R541	Retro-Reflective 175 CPL Red-Orange ScotchLite Stripes	R7		

Candle Power of Reflective Stripes (CPL)

Bullard Model Number	Stripe Daytime Color	Stripe Reflected Color	Typical Brightness (Candle Power)
STRSS/ST1R/ST2RWHT	White	White	100
STRSS/ST1R/ST2RRED	Red	Red	20
STRSS/ST1R/ST2RORG	Orange	Orange	25
STRSS/ST1R/ST2RYLW	Yellow	Yellow	60
STRSS/ST1R/ST2RGRN	Green	Green	15
STRSS/ST1R/ST2RBLU	Blue	Blue	10
ST1R500	Silver	White	500
STRSS500	Silver	White	500
ST1RORG175	Fluorescent Red-Orange	White	175
STRSSORG175	Fluorescent Red-Orange	White	175
R538	Silver	White	500
R540	Fluorescent Lime-Yellow	White	175
R541	Fluorescent Red-Orange	White	175

Custom striping available upon request.

Save time by ordering factory-applied stripes

To order your hard hat with the stripe applied, add the following codes to the end of your hard hat part number.

1. Start with the hard hat model number 2-digit code (on page 29).
2. Add the 2-letter color code (on page 29).
3. Add one letter for your choice of the suspension (on page 29).
4. If you have a custom pad printed hard hat, you may include the Build Your Bullard (BYB) project number at the end of the part number for convenient ordering.
5. Add any accessories that are factory applied.

Example:

Model # + Color + Suspension + Stripe = Part Number
 30 YL R S5 30YLR55 (shown on page 34)



Face Protection

Headgear. Brackets. Visors. Lightweight, comfortable face protection.

Sentinel Series Headgear

For the ultimate value in lightweight, comfortable face protection, Bullard Sentinel Series headgear is the obvious choice. All Sentinel Series headgear include two sizing features for enhanced comfort. The ratchet adjusts the headband to sizes 6¹/₂" to 8" and will not slip from the selected size. The crown strap conforms to the shape of the head. The brow pad, made of Sportek and offered exclusively by Bullard, pulls moisture away from the skin, creating a drier, more comfortable fit. Brow pads are hand washable and replaceable. Sentinel easily accommodates both primary eye protection and half-facepiece style respirators.

Hard Hat Mounted Face Protection

When the job calls for both head and face protection, choose from our complete line of dielectric nylon or gold anodized aluminum brackets. Brackets are available in several mounting styles that attach securely to Bullard hard hats and caps.

Dielectric brackets are formed from lightweight, durable nylon and are ideal for general duty applications. Bullard Gold Line brackets are constructed from rugged, gold anodized aluminum. They are highly resistant to corrosion and heat and are ideal for chemical handling and high-heat industrial applications.

Visors

Bullard visors conform to ANSI/ISEA Z87.1-2015 standard for eye and face protection when used in combination with Bullard headgear or faceshield.

Bullard Visor Applications

Activity	Hazards	Impact Protection Needed	Suggested Visor Material	Appropriate Bullard Visor Models
Chemical handling	Chemical splash or spill, acid burns, fumes, glass breakage	Z87	Acetate, Tritan™	640M, 840M, 1040, CS40, 680T, 840MX2, 840TX2, 840T, 860T, 880T, WS60TM
Laboratory operations	Chemical splash or spill, acid burns, fumes, glass breakage	Z87	Acetate, Tritan	640M, 840M, 1040, CS40, 680T, 840MX2, 840TX2, 840T, 860T, 880T, WS60TM
Grinding	Flying particles, dust	Z87+	Polycarbonate, Tritan	640P, 640PW3, 640PW5, 840P, 860P, 880P, WS60PM, 680T, 840PW3, 840PW5, 840PX2, 840TX2, 840T, 860T, 880T, WS60TM
Sawing	Flying particles, dust	Z87+	Polycarbonate, Tritan	640P, 840P, 860P, 880P, WS60PM, 680T, 840T, 860T, 880T, WS60TM
Machining	Flying particles, mists, vapors	Z87+	Polycarbonate, Tritan	640P, 840P, 860P, 880P, WS60PM, 680T, 840PX2, 840TX2, 840T, 860T, 880T, WS60TM
Medical examinations, first aid	Contact with body fluids/bloodborne pathogens	Z87	Acetate, Tritan	640M, 840M, 1040, CS40, 680T, 840PX2, 840TX2, 840T, 860T, 880T, WS60TM
Pesticide/fertilizer application	Chemical splash or spill, airborne chemicals	Z87	Acetate, Tritan	640M, 840M, 1040, CS40, 680T, 840T, 860T, 880T, WS60TM
Spray cleaning, (dirt, grime, etc.)	Flying particles, mists, splash	Z87	Polyester	840ME, E840ME
Molten metal handling	Molten splash	Z87	Polycarbonate	680P, 840P, 840PX2, 840TX2, 860P, 880P, WS60PM
Tree trimming	Flying particles	Z87	Mesh Screen	6S24, 8S24
Soldering, brazing	Infrared light, flying particles	Z87+	Polycarbonate	640PW3, 640PW5, 840PW3, 840PW5, 840PX2W3, 840PX2W5

Face Protection

Sentinel Headgear

The Bullard Sentinel Series headgear offers the ultimate value in lightweight, comfortable face protection. This lightweight molded ABS plastic headgear is non-conductive when used with a non-conductive visor. It includes a Flex-Gear® ratchet suspension and a Sportek brow pad to pull moisture away from the skin. Available with or without a chin protector.

- SENTINEL1** Faceshield Headgear
- Faceshield sold separately
 - Standard headgear with black ABS crown protector
 - Flex-Gear® ratchet sizing with Sportek brow pad (TT3)
 - For use with Bullard faceshields
 - Meets or exceeds ANSI/ISEA Z87.1-2015



- SENTINEL2** Faceshield Headgear
- Faceshield sold separately (840TX2, 840MX2, 840PX2, 840PX2W3 OR 840PX2W5)
 - Standard headgear with black ABS crown and chin protector combination
 - Flex-Gear® ratchet sizing with Sportek brow pad (TT3)
 - Meets or exceeds ANSI/ISEA Z87.1-2015



- CP1** Chin Protector
- Black ABS replacement chin protector
 - For use with 840MX2, 840PX2, 840TX2, 840PX2W3, and 840PX2W5



- CP2** Chin Protector
- Clear polycarbonate replacement chin protector
 - For use with 840MX2, 840PX2, 840TX2, 840PX2W3, and 840PX2W5



Acetate

Meets ANSI/ISEA Z87.1-2015, Z87, Non-impact Protector Testing Requirements

- 840MX2** Visor
- 7" x 15" x .040"
 - Clear flat acetate visor
 - Holes at bottom of visor to accommodate chin protector - Should be used with CP1/CP2 only



Polycarbonate

Meets ANSI/ISEA Z87.1-2015, Z87+, Impact Protector Testing Requirements

- 840PX2** Visor
- 7" x 15" x .040"
 - Clear heat-formed polycarbonate visor
 - Holes at bottom of visor to accommodate chin protector - Should be used with CP1/CP2 only



- 840PX2W3** Visor
- 7" x 15" x .040"
 - Shade 3 polycarbonate visor
 - Holes at bottom of visor to accommodate chin protector - Should be used with CP1/CP2 only



- 840PX2W5** Visor
- 7" x 15" x .040"
 - Shade 5 polycarbonate visor
 - Holes at bottom of visor to accommodate chin protector - Should be used with CP1/CP2 only



Tritan™

Meets ANSI/ISEA Z87.1-2015, Z87+, Impact Protector Testing Requirements

- 840TX2** Visor
- 7" x 15" x .040"
 - Clear heat-formed Tritan™ visor
 - Holes at bottom of visor to accommodate chin protector - Should be used with CP1/CP2 only



Face Protection

Nylon Brackets

Dielectric brackets are formed from lightweight, durable nylon and are ideal for general-duty applications.

33YLR with
312B Bracket
and 840T
Faceshield



- 300B** Dielectric Bracket
- Front mounting nylon bracket
 - For cap style Models S51, S61, S62, C30, Advent®, and Bump Cap



- 300BW** Dielectric Bracket
- Front mounting nylon bracket with neoprene gasket
 - For cap style Models S51, S61, S62, C30, Advent®, and Bump Cap



- 312B** Dielectric Bracket
- Front mounting nylon bracket
 - For full-brim hat Models S71, C33, C34 and C35



- 400** Dielectric Bracket
- Front mounting nylon bracket with blades for accessory slot attachment
 - For slotted cap style Models S51, S61, S62, and C30



- 400W** Dielectric Bracket
- Front mounting nylon bracket with neoprene gasket and blades for accessory slot attachment
 - For slotted cap style Models S51, S61, S62, and C30



Face Protection

Aluminum Brackets

Gold Line brackets are constructed from rugged, gold-anodized aluminum. They are ideal for chemical handling and high heat applications.

100G

Gold Line Bracket

- Front mounting aluminum bracket
- For cap style Models S51, S61, S62, C30, 911C, and Bump Cap

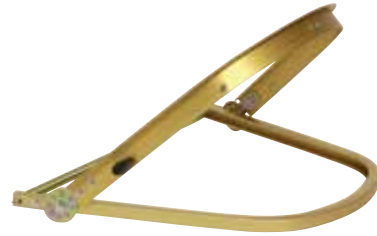

110G

Gold Line Bracket

- Back mounting aluminum bracket
- For cap style Models S51, S61, S62, C30, and 911C



112G

Gold Line Bracket

- Front mounting aluminum bracket
- For full-brim hat Models S71, C33, C34, and 911H



500M

Gold Line Bracket

- Front mounting aluminum bracket with blades for accessory slot attachment
- For cap style Model C30



Face Protection

Multi-Fit Faceshield Visors

Bullard visors are designed to provide limited protection to the face from many hazards. When used with Bullard brackets, all visors conform to ANSI/ISEA Z87.1-2015 for faceshields. For maximum versatility, all Bullard visors fit all Bullard brackets and most competitive models. These visors are available in a variety of materials and sizes for specific applications, environments, and performance needs.



Tritan™ Visors - Chemical Splash, Impact Resistance

- Clear Tritan visor for all Bullard brackets and several competitive models
- Meets ANSI/ISEA Z87.1-2015, Z87+, Impact Protector Testing Requirements

- 680T***
- 6" x 15" x .080"
 - heat-formed



- 840T**
- 8" x 15" x .040"
 - heat-formed



- 860T**
- 8" x 15" x .060"
 - heat-formed



- 880T**
- 8" x 15" x .080"
 - heat-formed



- WS60TM**
- 9" x 19 3/4" x .060"
 - flat visor



Dark Green Acetate Visors - Chemical Splash Resistance

- Dark green flat acetate visor for all Bullard brackets and several competitive models
- 14± 4 percent visible light transmittance
- Meets ANSI/ISEA Z87.1-2015 Non-impact Protector Testing Requirements

- 640G***
- 6" x 15" x .040"
 - flat visor



- 840MG**
- 8" x 15" x .040"
 - flat visor



*Not a multi-fit visor

Face Protection

Multi-Fit Faceshield Visors

Acetate Visors - Chemical Splash Resistance

- Clear acetate visor for all Bullard brackets and several competitive models
- Meets ANSI/ISEA Z87.1-2015 Non-impact Protector Testing Requirements

- 1040**
- 10" x 15" x .040"
 - flat visor



- 640***
- 6" x 15" x .040"
 - flat visor



- 840M**
- 8" x 15" x .040"
 - flat visor



- CS40**
- 9" x 19 3/4" x .040"
 - Specially designed for chemical splash applications
 - flat visor



- 840MH**
- 8" x 15" x .040"
 - heat-formed



- 860H**
- 8" x 15" x .060"
 - heat-formed



Polycarbonate Visors - Impact Resistance

- Clear polycarbonate visor for all Bullard brackets and several competitive models
- Meets ANSI/ISEA Z87+ Impact Protector Testing Requirements

- 680P***
- 6" x 15" x .080"
 - heat-formed



*Not a multi-fit visor

Face Protection

Multi-Fit Faceshield Visors

Polycarbonate Visors - Impact Resistance continued

- 840P**
- 8" x 15" x .040"
 - heat-formed



- 860P**
- 8" x 15" x .060"
 - heat-formed



- 880P**
- 8" x 15" x .080"
 - heat-formed



- WS60PM**
- 9" x 19 3/4" x .060"
 - flat visor



Polycarbonate Shade Visors - Impact Resistance

- Polycarbonate visor for all Bullard brackets and several competitive models
- Meets ANSI/ISEA Z87.1-2015, Z87+ Impact Protector Testing Requirements

- 640PW3***
- 6" x 15" x .040"
 - Shade 3
 - flat visor



- 640PW5***
- 6" x 15" x .040"
 - Shade 5
 - flat visor



- 840PW3**
- 8" x 15" x .040"
 - Shade 3
 - flat visor



- 840PW5**
- 8" x 15" x .040"
 - Shade 5
 - flat visor



*Not a multi-fit visor



Face Protection

Multi-Fit Faceshield Visors

Polyester Visors - Splash Resistance

- Clear flat visor for all Bullard brackets and several competitive models
- Meets ANSI/ISEA Z87.1-2015 Non-impact Protector Testing Requirements

- 840ME**
- 8" x 15" x .040"
 - flat visor



- E840ME**
- 8" x 15" x .040"
 - economical option
 - flat visor



Mesh Screen Visor - Fog, Scratch Resistance

- Mesh black steel screen visor fits all Bullard brackets
- Meets ANSI/ISEA Z87.1-2015 Non-impact Protector Testing Requirements

- 8S24**
- 8" x 15" x 24 mesh
 - with aluminum band
 - flat visor



- 6S24***
- 6" x 15" x 24 mesh
 - with plastic band
 - flat visor



*Not a multi-fit visor

Visor Material Performance

	Acetate	Tritan™	Polycarbonate	Polyester	Mesh Screen
Clarity	Best	Better	Better	Good	N/A
Chemical splash	Best	Better	Fair	Low	N/A
Alkalines	Best	Better	Fair	Better	N/A
Acids	Best	Better	Fair	Better	N/A
Solvents	Good	Good	Good	Good	N/A
Temperature resistance	Good	Better	Best	Low	8S24 (Metal Frame) Best 6S24 (Plastic Frame) Low
Impact & penetration	Good	Better	Best	Low	Good
Fog resistance	Better	Good	Good	Good	Best
Scratch resistance	Best	Better	Best	Better	Best
UV radiation	Fair	Better	Best	Fair	N/A



Body Temperature Management

Worker comfort. Heat stress avoidance. Improved productivity. Bullard offers Body Temperature Management products to keep workers cool while on the job.

Isotherm® Cool Vest

Bullard revolutionary Isotherm® technology offers unparalleled cooling power. Unlike ice or gel packs that steadily lose their effectiveness, Bullard Isotherm® Cool Vests will remain at a CONSTANT 55°F for hours of cooling. Isotherm® can help reduce the chance of heat-related illnesses that sometimes occur in today's difficult work environments. Isotherm® is ergonomically designed, quick to recharge, and does not feel wet against the skin. It uses a simple, interchangeable front/back cool pack system that provides continuous cooling to the worker's upper body. The vests are easily adjustable for maximum comfort and flexibility. Dark blue vest material is flame retardant. Fits medium to extra-large sizes.

Isotherm® provides cooling for approximately 2^{1/2} hours. The period of cooling depends solely on work activity and environmental conditions. Weight: 6.5 lbs. (2.9kg).

The Isotherm® Class 2 provides the same revolutionary cooling while also meeting the ANSI/ISEA 107-2010 Class 2 high-visibility requirements. Wear this vest when working on or near roadways to meet the U.S. Dept. of Transportation Federal Highway Administration's *Manual on Uniform Traffic Control Devices*. Fits extra-large sizes only.

Isotherm® Replacement Packs

No waiting. No down time. Keep extra cool packs ready for instant on-site changes. Made of specially engineered plastic, Isotherm® packs are designed to expand up to 400% without damage. The cooling agent within the pack is a safe, non-toxic, and non-carcinogenic formulation. Cool packs may be re-energized thousands of times, providing hours of safe, controlled body temperature management. Placed in a cooler of ice water, the cool packs will fully recharge in approximately 20 minutes. However, ice water is not necessary as the phase change technology actually begins recharging the packs whenever they are placed in an environment that is cooler than 55°F.

Evaporative Cooling Vests

Stay cool for hours with Bullard's uniquely designed Evaporative Cooling Vest. The vest material is made to be submerged in cold water for 1-2 minutes. Once submerged, wring out the excess water, put the vest on, and stay cool for several hours. It's fast, easy, and convenient. The economical solution to keeping cool while on the job.

Isotherm® Cool Vest

- ISO2** Isotherm® 2
- Cooling vest, fits medium to large sizes (32"-42")
 - Includes vest and one set of packs
 - Dark blue, flame retardant fabric



**ISO2
ISO2XL**

- ISO2XL** Isotherm® 2 Extra-Large
- Cooling vest, fits XL and 2XL sizes (42"-52")
 - Includes vest and one set of packs
 - Dark blue flame retardant fabric

- ISOC2** Isotherm® Class 2
- Cooling vest accommodates XL sizes
 - Cooling vest meets ANSI/ISEA 107-2010 Class 2 high-visibility requirements
 - Includes vest and one set of packs
 - Fluorescent yellow and reflective striping



ISOC2

- ECVL** Evaporative Cooling Vest, Large (40" - 42")

- ECVXL** Evaporative Cooling Vest, Extra-Large (43" - 45")



**ECVL
ECVXL**

- ISO2P** Replacement Packs
- Isotherm® vests
 - One set of two packs (front and back)

- ISO2V** Replacement Vest
- ISO2, medium to large sizes (32"-42")
 - Includes vest only
 - Dark blue, flame retardant fabric

- ISO2XLV** Replacement Vest
- ISO2, XL and 2XL sizes (42"-52")
 - Includes vest only
 - Dark blue, flame retardant fabric

- ISOC2V** Replacement Class 2 Vest
- ISOC2 vest only, XL
 - Fluorescent yellow and reflective striping
 - Meets ANSI/ISEA 107-2010 Class 2 high-visibility requirements



The Turtle Club® For People Who Do Things Right!

Founded 1946

Most news is made when things go wrong, but shouldn't employees get recognition for doing things right? That's the reason the Turtle Club® was founded. This organization is dedicated to saving lives and preventing injuries by promoting the acceptance and use of hard hats. Industrial accidents can happen anytime and anywhere, so wearing required head protection can reduce the risk of serious injury. The Turtle Club® honors men and women who escaped injury because they were wearing hard hats at the time of industrial accidents.

A Different Kind of Safety Incentive

Safety professionals are always looking for new ways to promote safety both on and off the job. While incentives and awards programs are excellent, most focus on accident prevention. The Turtle Club® is a participatory program for workers that have proven to be a valuable adjunct to traditional industry head protection safety efforts.

Sixty Years and Still Going Strong

The Turtle Club® was founded in 1946 by C. R. "Rusty" Rustemeyer, Safety Director at Canadian Forest Products, Ltd. In 1950, Mr. Edward W. Bullard, Sr., was appointed the Turtle Club® sponsor. This appointment was particularly appropriate since, in 1919, Mr. Bullard developed the industry's first universally accepted hard hat, the original "Hard Boiled®" hat. Today, the club's international sponsor is Mr. E. D. "Jed" Bullard, grandson of E. W. Bullard. Because of Jed Bullard's commitment and efforts, interest in the club remains active, and membership continues to grow.

The Turtle Club®

A Tradition Continues

Membership requirements for The Turtle Club® are the same today as they were in 1946. Men and women who have escaped serious injury by wearing hard hats can be nominated for membership by their supervisor or company safety director. Each new member receives a new hard hat, membership certificate, membership card, Turtle Club® pin, and Turtle Club® decal. There are no dues or membership fees.

A Dedication to Safety

Members of the club pledge to "Practice safety, wear head protection when necessary, and to conscientiously encourage others to do so." This pledge, though more than 65 years old, is just as important today as it was six decades ago.

Joe Navarrete, Bullard Turtle Club® Member:

"While rigging combustion turbine air and fuel line piping on the bed of a pitman boom truck, Joe Navarrete's foot slipped. As he stood up to regain his balance, he stepped off the edge of the truck bed, landing on his right knee, left elbow, and his head. He stood up after the fall, actually returned to work the next day, sore and bruised but definitely happy that his Bullard hard hat saved his life."

-Chris Bornhauser



Nominate a Turtle Club® Member today at www.bullard.com/TurtleClub



Respiratory Protection and Air Quality Products

Blasting and Grinding • Painting and Powder Coating • Welding
Clean Room Applications • Pharmaceutical Manufacturing •
Infection Control • Hospital Preparedness • Chemical Handling

877-BULLARD (285-5273) • International calls +1-859-234-6616

Respiratory Protection

Respiratory Protection Resources	
Respiratory Protection.....	50
Key Terms	53
OSHA Regulations	53
Assigned Protection Factors.....	57
Bullard Respirator Application Guide.....	58
Powered Air-Purifying Respirator Selection Chart.....	60
SparxLift PAPR Selection Chart	70
Fittings Selection Guide	92, 198
CC20 Supplied Air Respirator Selection Chart.....	94
LF Series Selection Chart.....	110
RT Series SAR Selection Chart	118
GenVX® Series SAR Selection Chart.....	129
88VX Series SAR Selection Chart	141
GR50 Series SAR Selection Chart	154
Spectrum Series® Selection Chart.....	164
SparxLift SAR Selection Chart	188
Cubic Feet Per Minute Calculator.....	202
Clean Air Box (CAB) Selection Chart.....	211
Free-Air® Pump Selection Chart	218



⚠ WARNING

Consult product literature and instruction manuals for information on the proper function, use and maintenance of these respirators. Before using a Bullard respirator, Federal Law requires the employer to identify and evaluate the respiratory hazard(s) in the workplace including a reasonable estimate of employee exposure to respiratory hazard(s) and an identification of the contaminant's chemical state and physical form. Do not exceed maximum use concentrations established by OSHA, EPA, NIOSH, ACGIH or other regulatory standards.

In accordance with Title 42 Code of Federal Regulations Part 84 and 29 CFR 1910.134, respirator repairs or adjustments shall be made using only Bullard approved parts for use as part of a NIOSH-approved respirator assembly. Use of any other parts on these respirators VOIDS NIOSH APPROVAL. Failure to follow these instructions could result in death or serious injury.

Respiratory Protection

Work Systems

Bullard offers totally configured work systems for use in a wide variety of applications - from painting and abrasive blasting to pharmaceutical and chemical manufacturing. Everything you need for effective respiratory protection is provided in one complete package.



**Spectrum Series®
SPECLSYS**



**FAMB Series
FAMBSYS**



**GenVX® Series
GENVXSYS**



**CC20 Series
CC20SYS**



**GR50 Series
GR50SYS**



**Spectrum Series®
SPECICESYS**



**GenVX® Series
GENVXICESYS**



**CC20 Series
CC20ICESYS**



**GR50 Series
GR50ICESYS**

Applications



Industry	EVA Series	EVAHL Series	CC20 Series	RT Series	LF Series	Spectrum Series®	FAMB2 Series	GR50 Series	GenVX® Series	88VX Series	SparxLift
Painting	•	•	•	•	•	•	•	•	•	•	
Chemical Handling	•	•	•	•	•	•	•	•			
Healthcare	•	•	•	•	•						
Pharmaceutical	•	•	•	•	•	•					
Welding	•						•				•
Abrasive Blasting									•	•	
Grinding	•							•			•

Respiratory Protection

Bullard Relies on DuPont Hoods for Superior Protection

Our standards for developing respiratory protection equipment are high because we know workers face many hazards while on the job. Our products provide workers with superior protection, reliability, and durability for the unique way they work. That's why Bullard chooses Dupont™ Tychem® Hoods for our Powered Air-Purifying and Supplied Air Respirator systems.

Two Preferred Hood Styles

The DuPont™ Tychem® QC hood style is a lightweight, durable fabric that utilizes the strength of DuPont™ Tyvek® fabric with a polyethylene coating for added chemical protection. The Tychem® QC fabric provides workers with protection against more than 40 chemical challenges. This hood is the perfect choice for light splash protection in a variety of industrial environments, including petroleum refining, pulp and paper manufacturing, food processing, chemical processing, and pharmaceutical manufacturing.

The DuPont™ Tychem® SL hood delivers superior protection against a range of chemical environments and hazards. This hood utilizes Saranex® 23-P film laminated to Tyvek® fabric to provide a rugged and durable hood that resists many chemicals. The Tychem® SL fabric provides protection against more than 120 chemical challenges. This hood style is preferred by users who work in waste management, hazardous remediation, paint spraying, and nuclear environments.

The DuPont™ Tychem® QC and Tychem® SL Hoods provide a wide variety of simple, effective and economical options for workers needing respiratory protection in industrial environments. Dupont hoods are NIOSH approved for use in Bullard's Powered Air-Purifying Respirator (EVA/EVAHL Series) and Supplied Air Respirator (CC20 Series) systems.



What are the key terms?

- APF** - Assigned Protection Factor (APF) is the workplace level of respiratory protection that a respirator or class of respirator is expected to provide to employees when the employer implements a continuing, effective respiratory protection program.
- IDLH** - Immediately Dangerous to Life and Health (IDLH) means an atmosphere that poses an immediate threat to life, would cause irreversible adverse health effects or would impair an individual's ability to escape from a dangerous atmosphere.
- MUC** - Maximum Use Concentration (MUC) means the maximum atmospheric concentration of a hazardous substance from which an employee can be expected to be protected when wearing a respirator, and is determined by the Assigned Protection Factor of the respirator or class of respirators and the exposure limit of the hazardous substance.
MUC = APF x PEL or IDLH concentration (whichever is lower).
- NIOSH** - National Institute for Occupational Safety & Health (www.cdc.gov/niosh) is a research organization that approves respirators.
- OSHA** - Occupational Safety & Health Administration (www.osha.gov) is an enforcement agency that ensures workplaces are following the standards detailed in 29 CFR 1910.134 and other standards.
- PEL** - The Permissible Exposure Limit (PEL) is the contaminant concentration enforced by OSHA.

What is the OSHA Regulation for Respiratory Protection?

29 CFR 1910.134 is the OSHA standard for respiratory protection.

In any workplace where respirators are necessary to protect the health of the employee or whenever respirators are required by the employer, the employer shall establish and implement a written respiratory protection program with worksite-specific procedures. The program shall be updated as necessary to reflect those changes in workplace conditions that affect respirator use. The employer shall include in the program the following provisions of this section, as applicable:

- Procedures for selecting respirators for use in the workplace.
- Medical evaluations of employees required to use respirators.
- Fit testing procedures for tight-fitting respirators.
- Procedures for proper use of respirators in routine and reasonably foreseeable emergency situations.
- Procedures and schedules for cleaning, disinfecting, storing, inspecting, repairing, discarding, and otherwise maintaining respirators.
- Procedures to ensure adequate air quality, quantity, and flow of breathing air for atmosphere-supplying respirators.
- Training of employees in the respiratory hazards to which they are potentially exposed during routine and emergency situations.
- Training of employees in the proper use of respirators, including putting on and removing them, any limitations on their use, and their maintenance.
- Procedures for regularly evaluating the effectiveness of the program.

 **WARNING**

Issuing a respirator does not constitute an OSHA compliant respiratory protection program.

An OSHA Compliant Respiratory Program

IS	IS NOT
Written	Verbal
Work site specific	Generic
Regularly reviewed for effectiveness	Static
Trained upon regularly	Operated without training
	Simply issuing a respirator

Respiratory Protection

What is the difference between OSHA and NIOSH?

OSHA, the Occupational Safety and Health Administration, is part of the Department of Labor and is the agency that inspects a workplace for safety compliance. As part of that inspection, if respirators are being used, one of the things the inspector will check to see is that the respirator is NIOSH approved. NIOSH, the National Institute for Occupational Safety and Health, administers a testing and certification program assuring commercial availability of respiratory protective devices that conform to the requirements of Title 42, Code of Federal Regulations, Part 84. NIOSH tests and certifies (i.e. approves) respiratory protective devices and purchases certified products on the open market to verify continued compliance with the requirements of the 42 CFR, Part 84. NIOSH does not conduct job site compliance inspections and cannot issue fines for non-compliance.

How do I select a respirator?

According to OSHA, it is the responsibility of the employer to evaluate workplace hazards (if any) and implement appropriate controls to protect the worker. When engineering and/or administrative controls aren't technically or financially feasible, Personal Protective Equipment (PPE) may be used to protect the worker. When respiratory PPE is needed, the following steps may be helpful as you select a respirator:

1. Identify the hazard(s) including:
 - Lack of Oxygen, Organic Vapor, Acid Gas, Particulate, Confined Space, Explosion Potential, etc.
2. Analyze the hazard(s) including:
 - Contaminant Concentration vs. the PEL & IDLH
 - MSDS, Air Sampling, NIOSH Guide to Chemical Hazards
 - Lower Flammable Limit
 - Boiling Point
 - Odor Threshold
 - Eye/Nose/Throat Irritation
 - Substance Specific Standards
3. Calculate the APF required
 - $APF = (\text{Contaminant Concentration}) / \text{PEL}$
4. Account for other considerations
 - Air source options (Compressor, Bottle, Ambient Air Pump, PAPR, APR)
 - Comfort (Length of time, Temperature)
 - Cost (Including fit testing and consumables)
5. Choose Respirator
 - Type: APR, PAPR, SAR, or SCBA
 - Head Top: Half-Mask, Full-Facepiece, Loose-Fitting Facepiece, Hood, Helmet
 - Evaluate Capabilities & Limitations



Who must receive a Medical Evaluation?

The employer shall provide a medical evaluation (at no cost to the employee) to determine the employee's ability to use a respirator, before the employee is fit tested or required to use the respirator in the workplace. A Physician or Licensed Health Care Professional (PLHCP) may perform medical evaluations using a medical questionnaire or an initial medical examination that obtains the same information as the medical questionnaire. The employer may discontinue an employee's medical evaluations when the employee is no longer required to use a respirator.

Respiratory Protection

How often must training be conducted?

Retraining shall be administered annually, and when the following situations occur:

- Changes in the workplace or the type of respirator render previous training obsolete.
- Inadequacies in the employee's knowledge or use of the respirator indicate that the employee has not retained the requisite understanding or skill.
- Any other situation arises in which retraining appears necessary to ensure safe respirator use.

Who must be fit tested and how often?

The employer shall ensure that any employee using a **tight-fitting facepiece** respirator is fit tested prior to initial use of the respirator, whenever a different respirator facepiece (size, style, model, or make) is used, and at least annually thereafter. The employer shall conduct an additional fit test whenever the employee reports, or the employer, Professionally Licensed Health Care Provider (PLHCP), supervisor, or program administrator makes visual observations of, changes in the employee's physical condition that could affect respirator fit. Such conditions include, but are not limited to: facial scarring, dental changes, cosmetic surgery, or an obvious change in body weight.

The fit test shall be administered using an OSHA-accepted Qualitative Fit Test or Quantitative Fit Test protocol. The OSHA-accepted QLFT and QNFT protocols and procedures are contained in Appendix A of the OSHA standard.

Note: Loose-Fitting Facepieces, Hoods, and Helmets do not require fit testing.

What are the regulations regarding breathing air for supplied air respirators?

Compressed breathing air shall meet at least the requirements for Grade D breathing air described in ANSI/Compressed Gas Association Commodity Specification for Air, G-7.1-1989, to include:

- Oxygen content of 19.5-23.5%.
- Hydrocarbon (condensed) content of 5 milligrams per cubic meter of air or less.
- Carbon monoxide (CO) content of 10 parts per million (ppm) or less.
- Carbon dioxide content of 1,000 parts per million (ppm) or less.
- Lack of noticeable odor.

Compressors used to supply breathing air to respirators are constructed and situated so as to:

- Prevent entry of contaminated air into the air-supply system.
- Minimize moisture content so that the dew point at 1 atmosphere pressure is 10 degrees F (5.56 deg.C) below the ambient temperature.
- Have suitable in-line air-purifying sorbent beds and filters to further ensure breathing air quality. Sorbent beds and filters shall be maintained and replaced or refurbished periodically following the manufacturer's instructions.
- Have a tag containing the most recent change date and the signature of the person authorized by the employer to perform the change. The tag shall be maintained at the compressor.
- For compressors that are not oil-lubricated, the employer shall ensure that carbon monoxide levels in the breathing air do not exceed 10 ppm.
- For oil-lubricated compressors, the employer shall use a high-temperature or carbon monoxide alarm, or both, to monitor carbon monoxide levels. If only high-temperature alarms are used, the air supply shall be monitored at intervals sufficient to prevent carbon monoxide in the breathing air from exceeding 10 ppm.
- The employer shall ensure that breathing air couplings are incompatible with outlets for nonrespirable work site air or other gas systems. No asphyxiating substance shall be introduced into breathing air lines.

Note: Ambient Air Pumps such as Bullard's Free-Air® Pumps are exempt from CO Monitoring and Air Sampling because they are not oil lubricated (OSHA Standards Interpretation July 7, 1994), (OSHA Standards Interpretation August 13, 1999).

⚠ WARNING: An important warning about the use of replacement parts

NIOSH Respirator Users Notice May 4, 2007:

"...Users of NIOSH approved respirators are cautioned against interchanging subassemblies or making unapproved modifications to their respirators. Respirators which have been modified by the interchanging of subassemblies or other deviations using parts not produced and distributed under the respirator manufacturer's controlled system, no longer meet the definition of being approved as a NIOSH certified respirator..."

This includes, but is not limited to, replacement lenses, blast respirator capes, cool tubes, and air supply hoses.



DEPARTMENT OF HEALTH & HUMAN SERVICES

Public Health Service

Centers for Disease Control
and Prevention (CDC)
National Institute for Occupational
Safety and Health (NIOSH)
National Personal Protective
Technology Laboratory (NPPTL)
P.O. Box 18070
Pittsburgh, PA 15236-0070
Phone: 412-386-4000
Fax: 412-386-4051
May 4, 2007

Respirator Users Notice

Subject: Use of Replacement and Spare Parts

The National Institute for Occupational Safety and Health (NIOSH) issues certificates of approval for specific and complete respirator assemblies after the respirator has been evaluated and found to comply with all the requirements of the NIOSH regulations at Title 42, *Code of Federal Regulations* (CFR) Part 84 (42 CFR Part 84). As part of this evaluation, NIOSH reviews the respirator manufacturer's quality control plan to determine if it is satisfactory. The respirator manufacturer¹ must address all the components of the respirator in its quality control plan, including those manufactured in-house and those obtained from suppliers. A respirator that includes any replacement or spare part that has not been inspected as part of the respirator manufacturer's quality control plan is in a configuration not evaluated by NIOSH, and is not NIOSH approved. Please consult the respirator manufacturer before purchasing and installing replacement or spare parts to ensure the NIOSH-approved configuration is maintained.

ADDITIONAL INFORMATION

This is an updated version of a previously-issued (November 6, 1984) Users Notice on the use of unapproved subassemblies. It is being reissued to clarify the interchangeability of respirator subassemblies and unapproved modifications to NIOSH certified (approved) respirators. In some cases even minor modifications to respirators may make significant changes in the performance of the respirator, even if the proposed replacement components or subassemblies (such as self contained breathing apparatus (SCBA) air cylinders or air supply hoses) meet the same component-specific industry safety and performance standards as those included in the NIOSH approval. Respirator manufacturers who modify certified respirators must test the modification to determine if the respirator continues to meet the minimum requirements of 42 CFR Part 84, and must submit the modifications to NIOSH. A user who modifies a certified respirator may not be able to determine whether a change will decrease respiratory protection. Several cases have been reported to NIOSH where unapproved modifications or use of an unapproved subassembly have resulted in respirator failures.

The NIOSH respirator certification regulation, 42 CFR Part 84, defines an approval as "a certificate or formal document issued by the Institute stating that an individual respirator or combination of respirators has met the minimum requirements of this part [84]." Approved is

¹ For the purposes of this notice, the term "respirator manufacturer" means the individual, partnership, company, corporation, association or other organization that holds the NIOSH-issued certificate of approval for a respirator.

Page 2 – Respirator Users Notice

defined to mean that the respirator conforms to the minimum requirements of the regulation. The minimum performance requirements include the applicable construction, performance, manufacturing system quality control and respiratory protection requirements set forth in 42 CFR Part 84. The regulation permits NIOSH to only approve complete respirator assemblies and prohibits the approval of respirator subassemblies such as SCBA air cylinders or supplied air respirator (SAR) air supply hoses. These requirements are intended to insure that one respirator manufacturer has overall control and responsibility for the integrity of the approved respirator. The respirator manufacturer has the responsibility to ensure that its replacement parts are "designed and constructed to ...maintain the effectiveness of the respirator." 42 CFR 84.62(b).

NIOSH requires the respirator manufacturer to file a quality control plan to assure the quality of the respiratory protection provided by the respirator for which the approval is sought. 42 CFR 84.40. Once approved, that approved quality control plan becomes part of, and is incorporated into, the certificate of approval. Compliance with that plan is a condition of approval. 42 CFR 84.42(c). The issuance of the certificate licenses the respirator manufacturer to use the NIOSH approval label but also obligates that respirator manufacturer "to maintain the approved quality control sampling schedule and the acceptable quality level for each characteristic tested..." 42 CFR 84.33(f).

Therefore, users of NIOSH approved respirators are cautioned against interchanging subassemblies or making unapproved modifications to their respirators. Respirators which have been modified by the interchanging of subassemblies or other deviations using parts not produced and distributed under the respirator manufacturer's controlled system, no longer meet the definition of being approved as a NIOSH certified respirator and the use of the NIOSH approval label is not authorized for that unit.

Sincerely yours,

Heinz W. Ahlers
Chief, Technology Evaluation Branch
National Personal Protective Technology Laboratory

What are Assigned Protection Factors (APFs)?

Assigned Protection Factor (APF) is the workplace level of respiratory protection that a respirator or class of respirators is expected to provide to employees when the employer implements a continuing, effective respiratory protection program. The APF required for an application can be calculated by dividing the airborne concentration of the contaminant by the PEL for that contaminant. The OSHA-recognized APFs for different types of respirators are found in the table (from 1910.134) below:

TABLE 1.—ASSIGNED PROTECTION FACTORS⁵

Type of respirator ^{1,2}	Quarter mask	Half mask	Full face-piece	Helmet/hood	Loose-fitting facepiece
1. Air-Purifying Respirator	5	³ 10	50
2. Powered Air-Purifying Respirator (PAPR)	50	1,000	⁴ 25/1,000	25
3. Supplied-Air Respirator (SAR) or Airline Respirator
• Demand mode	10	50
• Continuous flow mode	50	1,000	⁴ 25/1,000	25
• Pressure-demand or other positive-pressure mode	50	1,000
4. Self-Contained Breathing Apparatus (SCBA)
• Demand mode	10	50	50
• Pressure-demand or other positive-pressure mode (e.g., open/closed circuit)	10,000	10,000

Notes:

- ¹ Employers may select respirators assigned for use in higher workplace concentrations of a hazardous substance for use at lower concentrations of that substance, or when required respirator use is independent of concentration.
- ² The assigned protection factors in Table 1 are only effective when the employer implements a continuing, effective respirator program as required by this section (29 CFR 1910.134), including training, fit testing, maintenance, and use requirements.
- ³ This APF category includes filtering facepieces, and half masks with elastomeric facepieces.
- ⁴ The employer must have evidence provided by the respirator manufacturer that testing of these respirators demonstrates performance at a level of protection of 1,000 or greater to receive an APF of 1,000. This level of performance can best be demonstrated by performing a WPF or SWPF study or equivalent testing. Absent such testing, all other PAPRs and SARs with helmets/hoods are to be treated as loose-fitting facepiece respirators, and receive an APF of 25.
- ⁵ These APFs do not apply to respirators used solely for escape. For escape respirators used in association with specific substances covered by 29 CFR 1910 subpart Z, employers must refer to the appropriate substance-specific standards in that subpart. Escape respirators for other IDLH atmospheres are specified by 29 CFR 1910.134 (d)(2)(ii).

*Footnote 4 in essence states that in order to use an APF of 1,000, the respirator manufacturer shall provide evidence to the employer that the respirator demonstrates performance at a level of protection equal to or greater than 1,000. Bullard has long been a leader in protection factor research.

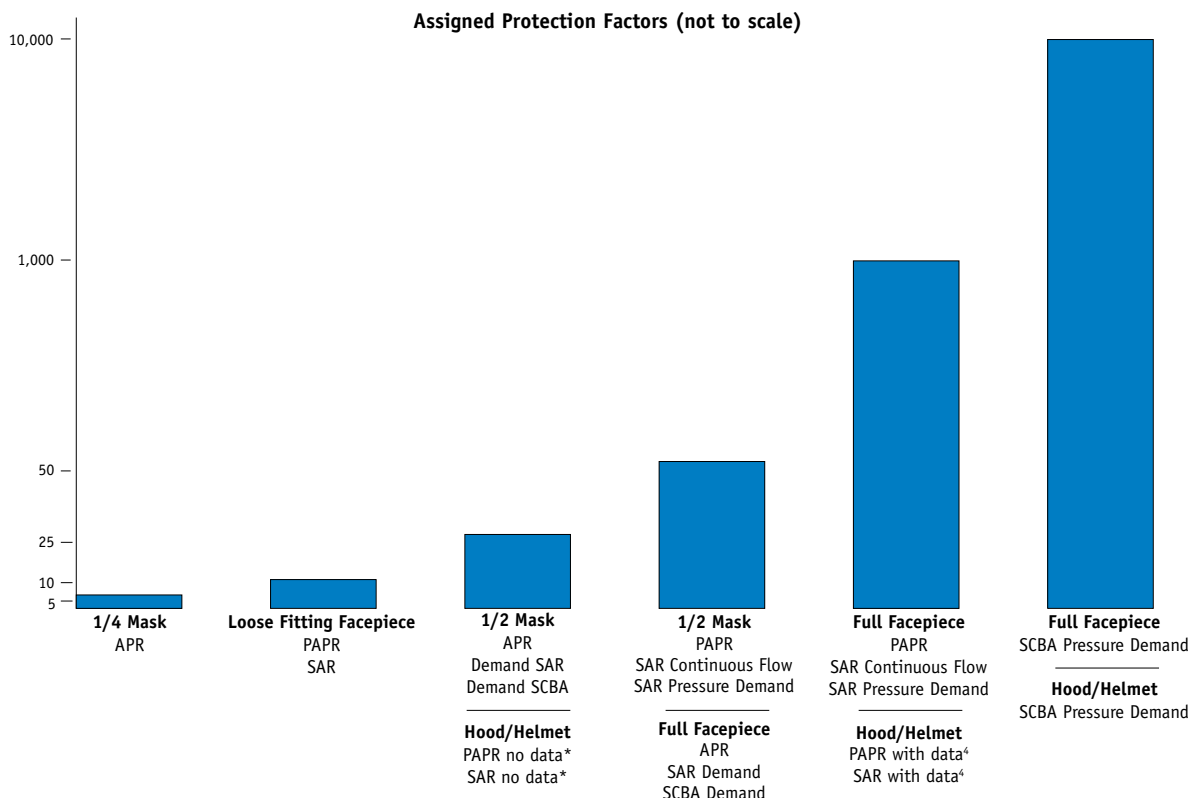

Respiratory Protection Application Guide

	Bullard Product	Respirator Type	NIOSH TC#	APF	3rd Party Validation
Supplied Air Respirators	Lancer	Type C/CE Helmet	19C-309	1,000	Caldwell 1994
	77 Series**	Type C/CE Helmet	19C-84	1,000	LLNL 1995
	88/88VX Series**	Type C/CE Helmet	19C-293	1,000	LLNL 1995
	GenVX® Series	Type C/CE Helmet	19C-0489 19C-0491 19C-0492 19C-0493 19C-0494 19C-0495 19C-0496	1,000	RDECOM 2012
	GR50 Series*	Type C Hood	19C-329	1,000	RDECOM 2012
	CC20 Series*	Type C Hood	19C-154	1,000	ORC 1997
	RT Series	Type C Hood	19C-412	1,000	RDECOM 2007
	PC90 Series**	Type C Hood/Suit	19C-280	1,000	Caldwell 1994
	FAMB Series	Type C ½ Mask	19C-469	50	OSHA Final APF Rule 2006
	Spectrum Series®	Type C Full Facepiece	19C-321 19C-322 19C-354 19C-387 19C-388	1,000	OSHA Final APF Rule 2006
	SparxLift Series	Loose-Fitting Facepiece	19C-0511 19C-0512 19C-0513 19C-0514 19C-0515 19C-0516 19C-0517 19C-0518 19C-0519 19C-0520 19C-0521 19C-0522	1,000	
Powered Air-Purifying Respirators (PAPRs)	PA20 CC20 Series**	LF/Hood	21C-0765	25	OSHA Final APF Rule 2006
	PA30 CC20 Series**	Hood	21C-0773 23C-2236 23C-2237	1,000	RDECOM 2003
	PA30 RT Series**	Hood	21C-0773 23C-2236 23C-2237	1,000	RDECOM 2004
	PA40 Spectrum**	Full Facepiece	21C-0774	1,000	OSHA Final APF Rule 2006
	PA30IS CC20 Series*	Hood	21C-0796 23C-2306 23C-2307	1,000	RDECOM 2006
	PA30IS RT Series	Hood	21C-0796 23C-2306 23C-2307	1,000	RDECOM 2006
	EVA CC20 Series*	Hood	21C-0836 23C-2510	1,000	RDECOM
	EVA RT Series	Hood	21C-0836 23C-2510	1,000	RDECOM
	EVA FAMB	½ Mask	21C-0486 23C-2511	50	OSHA Final APF Rule 2006
	EVA Spectrum	Full Facepiece	21C-0844 23C-2512	1,000	OSHA Final APF Rule 2006
	EVAHL CC20 Series*	Hood	21C-0922 23C-2765	1,000	RDECOM 2012
	EVAHL RT Series	Hood	21C-0922 23C-2765	1,000	RDECOM 2012
	SparxLift Series	Loose-Fitting Facepiece	21C-0940 21C-0941	1,000	

* Double Bib Models only

** Discontinued Products

Powered Air-Purifying Respirators (PAPRs)



What is a Powered Air-Purifying Respirator?

Powered Air-Purifying Respirators (PAPRs) use a battery-powered fan to draw in ambient air through filter cartridges. The purified air is then delivered to the user's hood, helmet, or facepiece via a breathing tube. A flow indicator is provided to check that there is an adequate volume of air available to the wearer prior to use. There are many different PAPR configurations available to best meet the needs of your working environment.

Configuring a Powered Air-Purifying Respirator System

There are many choices to make when piecing together components of a Powered Air-Purifying Respirator System. The following steps may help simplify this intimidating task:

- Choose Blower
- Choose Belt
- Choose Head Top with threaded T-Series or Clamp style connection
- Choose Battery (head top specific)
- Choose Suspension or Hard Hat (if applicable)
- Choose Breathing Tube
- Choose Filter/Cartridge
- Choose Charger
- Choose Accessories

Bullard PAPRs Provide Maximum Airflow Throughout the Entire Shift

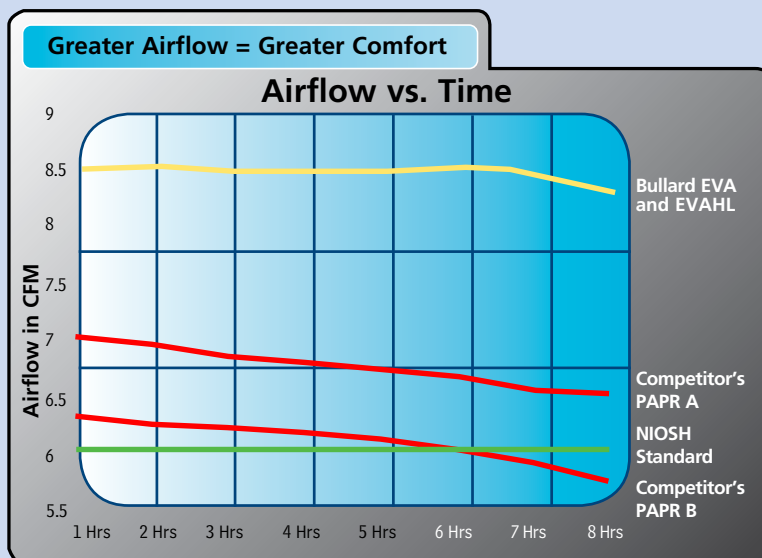

Powered Air-Purifying Respirators (PAPRs)

PAPR Selection Chart

1. Choose Blower



• EVA



• EVAHL

2. Choose Belt



• EVABELT1 - Comfort Decon
• EVAEXT1 - Vinyl extension



• EVABELT2 - Vinyl Decon
• EVAEXT1 - Vinyl extension

3. Choose Head Top



• 20TJN - Tychem® QC Single Bib
• 20TPN - With Solvent-Resistant Lens
• 20TJNT - Tychem® QC Single Bib, Threaded
• 20TPNT - With Solvent-Resistant Lens, Threaded



• 20TICN - Tychem® QC Double Bib
• 20TPCN - With Solvent-Resistant Lens
• 20TICNT - Tychem® QC Double Bib, Threaded
• 20TPCNT - With Solvent-Resistant Lens, Threaded



• 20SICN - Tychem® SL Double Bib w/Taped Seams
• 20TICSN - Tychem® QC Double Bib w/Taped Seams
• 20SICNT - Tychem® SL Double Bib w/Taped Seams, Threaded
• 20TICSNT - Tychem® QC Double Bib w/Taped Seams, Threaded



• 20SICH - Tychem® SL Double Bib with Taped Seams for Hard Hats
• 20TICH - Tychem® QC Double Bib for Hard Hats
• 20SICHT - Tychem® SL Double Bib with Taped Seams for Hard Hats, Threaded
• 20TICHT - Tychem® QC Double Bib for Hard Hats, Threaded



• 20LFM - Loose-Fitting Facepiece, Medium
• 20LFL - Loose-Fitting Facepiece, Large
• 20LFXL - Loose-Fitting Facepiece, Extra Large
• 20LF2S, 20LF2M, 20LF2L - Narrow Version



• RT1 - Tychem® QC Double Bib Hood
• RT2 - Tychem® SL (Saranex coated) Double Bib Hood with Taped Seams
• RT1T - Tychem® QC Double Bib Hood, Threaded
• RT2T - Tychem® SL (Saranex coated) Double Bib Hood with Taped Seams, Threaded



• RT3 - Tychem® QC Double Bib with Extra-Large Lens
• RT4 - Tychem® SL Saranex Coated Double Bib with Extra-Large Lens and Taped Seams
• RT3T - Tychem® QC Double Bib with Extra-Large Lens*, Threaded
• RT4T - Tychem® SL Saranex Coated Double Bib with Extra-Large Lens and Taped Seams*, Threaded



• GRH Nomex Grinding Hood for EVA
• GRHT



• PASPECL, PASPECS - Full-Facepiece, for EVA



• FAM2L, FAM2S, FAM2M - Half-Mask, for EVA



• SparxLift SLH - SparxLift Helmet with ADF and ratchet headgear (no shroud)



• SparxLift SLS1 - Loose-Fitting Facepiece Style 25 APF



• SparxLift SLS2 - Hood Style 1,000 APF

4. Choose Suspension or Hard Hat (Not required for masks or SparxLift)



• 20RT - Adjustable Flex-Gear® Ratchet Headband Suspension for All Heads



• C30R - With 6-point Flex-Gear® Ratchet Suspension for 20SICH, 20TICH, GRH



• S51R - With 4-point Flex-Gear® Ratchet Suspension for 20SICH, 20TICH, GRH



• 20NC - Chinstrap, for Hoods

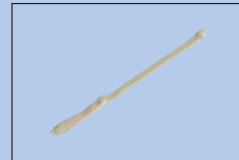

• ES42 - Chinstrap, for Hard Hats

5. Choose Breathing Tube



• PA1BT - 26" for Hoods
• PA1BTXS - 22" for Hoods
• PA1BTXL - 32" for Hoods
• PAHBT - 26" Threaded
• PAHBTXS - 22" Threaded
• PAHBTXL - 32" Threaded
• PAHBTBK - Retractable BT for Backpack



• PA20LFBT - 32" for 20LF
• PA20LFBXS - 26" for 20LF
• PA20LFBTXL - 38" for 20LF



• PA4BT - 33" for PASPEC



• PAFAMBT for FAMB

6. Choose Filter Cartridge and Accessories

For EVA and EVAHL



• PAPRPF2 - Pre-Filter Cover/Retainer 3 Per Pack



• PAPRPF2 - Pre-Filter for EVA OVAGHE



• PAPRFC3 - HEPA (HE)



• PAPRFC4 - OV/AG/HE
• PAPRFC5 - Combination



• PAPRSC2 - Decon Shower Cap for EVA HE



• PAPRSC3 - Shower Cap for EVA OVAGHE

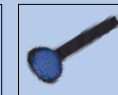

• EVA DCFR1 - PAPR Dust Cover for use with HE Filter and Belt

7. Choose Charger



• EVASMC - Smart Charger, Single Port
• EVASMC2 - Smart Charger, Single Port
• EVAHLSMC - Smart Charger, Single Port
• EVAHLSMC2 - Smart Charger, Single Port



• EVAGC - Gang Charger, 6 Port
• EVAHLGC - Gang Charger, 6 Port



• EVASMC2 - Single Port Genius Charger with EVALuator Software

EVA Powered Air-Purifying Respirator

Reliable, Easy-To-Use Technology

EVA was uniquely designed for all-day worker comfort. Engineers studied the motions, actions, and requests from experts in the field to design the most comfortable and user-friendly PAPR on the market.

Visual Fuel Gauge



The easy to read fuel gauge displays remaining battery capacity at a glance. Wearers can check battery status at any time while using EVA.

Active Flow Technology

Another innovation from Bullard, Active Flow Technology automatically responds to a worker's need for more or less air flow. This intelligent system is continuously working to maintain constant air flow, regardless of filter type, hood type, filter loading, or battery capacity.

Integrated Alarms

Two distinct audible alarms notify wearers of low battery and low air flow. These alarms are designed so the sound of the alarm travels through the breathing tube directly to the wearer's ear.

Durability

EVA is powered by a long-lasting 10,000-hour brushless motor. Unlike other motors that can quickly wear out, this durable brushless motor is designed for long-term reliable use.

Single Filter Design

EVA offers a single filter design for easy use. While other manufacturers' PAPRs may require up to three combination filters, EVA makes it simple, with a single easy-to-install filter.

Filter Locking Tab



EVA helps ensure positive filter installation with a single click. The filter locking tab notifies the user that the filter is in place with both a visual indication and audible click.

Distinctive Ergonomic Design



The streamlined form factor of EVA makes it lightweight, eliminates bulky corners that can dig into the wearer's back, and balances the unit's weight for maximum comfort.



EVA Series Powered Air-Purifying Respirator

EVA Systems

A NIOSH approved EVA Powered Air-Purifying Respirator System consists of four components:

- (1) Hood or Mask
- (2) Breathing Tube
- (3) Purifying Filter Cartridge
- (4) Blower Assembly



- Approval No. 21C-0836 Hoods, HE filter
 23C-2510 Hoods, OVAG filter
 21C-0844 Spectrum®, HE
 23C-2512 Spectrum®, HE, OVAGHE
 21C-0846 FAMB, HE
 23C-2511 FAMB, OVAGHE
 23C-2886 Hoods, Combination

All of these components must be present and properly assembled to constitute a NIOSH-approved respirator.

PAPRs with Single Bib Hoods

- Assemblies include blower (EVA1), belt (EVABELT1), battery (EVABAT1), breathing tube, charger (EVASMC), air flow indicator (PA1AFI), and head top (filter not included)

- EVA20TJ** with 20TJ hood and PA1BT breathing tube
EVA20TJT with 20TJ Quick-Attach T-Series hood and PAHBT breathing tube



20TJ hood

PAPRs with Double Bib Tychem® QC Hoods

- Assemblies include blower (EVA1), belt (EVABELT1), battery (EVABAT1), breathing tube, charger (EVASMC), air flow indicator (PA1AFI), and head top with ratchet suspension (filter not included)

-  **EVA20TIC** with 20TIC hood and PA1BT breathing tube
EVA20TICT with 20TICT Quick-Attach T-Series hood and PAHBT breathing tube
EVA20TICS with 20TICS hood (lens long outer bib, taped seams) and PA1BT breathing tube
EVA20TICST with 20TICST Quick-Attach T-Series hood and PAHBT breathing tube

- EVART1** with RT1 hood (oversized lens and inflatable neck cuff) and PA1BT breathing tube
EVART1T with RT1T Quick-Attach T-Series hood (oversized lens and inflatable neck cuff) and PAHBT breathing tube
EVART3 with RT3 hood (oversized lens and no headband) and PA1BT breathing tube
EVART3T with RT3T Quick-Attach T-Series hood (oversized lens and no headband) and PAHBT breathing tube



20TIC hood

*Add DB suffix to substitute EVABELT1 for decon belt (EVABELT2)

 Best Seller

Replacement Headpieces

pp. 81-84

877-BULLARD (285-5273) • International calls +1-859-234-6616

EVA Series Powered Air-Purifying Respirator

EVA Systems

PAPRs with Double Bib Hoods and Head Protection

- Assemblies include blower (EVA1), belt (EVABELT1), battery (EVABAT1), charger (EVASMC), air flow indicator (PA1AFI), breathing tube, head top, and S51R hard hat (filter not included)

EVA20TICH	with 20TICH hood (Tychem® QC) and PA1BT breathing tube
EVA20TICHT	with 20TICHT Quick-Attach T-Series hood (Tychem® QC) and PAHBT breathing tube
EVA20SICH	with 20SICH hood (Tychem® SL) and PA1BT breathing tube
EVA20SICHT	with 20SICHT Quick-Attach T-Series hood (Tychem® SL) and PAHBT breathing tube

*Add DB suffix to substitute EVABELT1 for decon belt (EVABELT2)



EVA20TICH

EVA Series Assemblies

PAPRs with Double Bib Tychem® SL Hoods (Saranex Coated)

- Assemblies include blower (EVA1), belt (EVABELT1), battery (EVABAT1), charger (EVASMC), air flow indicator (PA1AFI), breathing tube, head top, and ratchet suspension (20RT) (filter not included)

EVA20SIC	with 20SICN hood (taped seams) and PA1BT breathing tube
EVA20SICT	with 20SICNT Quick-Attach T-Series hood (taped seams) and PAHBT breathing tube
EVART2	with RT2 hood (oversized lens and inflatable neck cuff) and PA1BT breathing tube
EVART2T	with RT2 Quick-Attach T-Series hood (oversized lens and inflatable neck cuff) and PAHBT breathing tube
EVART4	with RT4 hood (oversized lens and no headband) and PA1BT breathing tube
EVART4T	with RT4 Quick-Attach T-Series hood (oversized lens and no headband) and PAHBT breathing tube

*Add DB suffix to substitute EVABELT1 for decon belt (EVABELT2)



EVART4

PAPRs with Double Bib Nomex Grinding Hoods

- Assemblies include blower (EVA1), belt (EVABELT1), battery (EVABAT1), charger (EVASMC), air flow indicator (PA1AFI), breathing tube, head top, and ratchet suspension (20RT) (filter not included)

EVAGRH	with GRHRT hood
EVAGRHT	with GRHRT Quick-Attach T-Series hood

*Add DB suffix to substitute EVABELT1 for decon belt (EVABELT2)



EVAGRH

EVA Series Powered Air-Purifying Respirator

EVA Series Assemblies

PAPRs with Full-Face Masks

- Assemblies include blower (EVA1), belt (EVABELT1), battery (EVABAT2), charger (EVASMC), air flow indicator (PA4AFI), breathing tube (PASPECBT), and mask (filter not included)

EVASPECL with Med/Large Spectrum® Full-Face Mask

EVASPECS with Small Spectrum® Full-Face Mask

***Add DB suffix to substitute EVABELT1 for decon belt (EVABELT2)**



EVASPECL

PAPRs with Half-Face Masks

- Assemblies include blower (EVA1), belt (EVABELT1), battery (EVABAT2), charger (EVASMC), air flow indicator (PA4AFI), breathing tube (PAFAMBT) and mask (filter not included)

EVAFAML with Large FAM2L Half-Face Mask

EVAFAMM with Medium FAM2M Half-Face Mask

EVAFAMS with Small FAM2S Half-Face Mask

***Add DB suffix to substitute EVABELT1 for decon belt (EVABELT2)**



EVAFAMM

EVA Series Assemblies

Pandemic Preparedness Systems

- Assemblies include blower (EVA1) with filter (PAPRFC3), belt (EVABELT1), battery (EVABAT1), air flow indicator (PA1AFI), breathing tube (PA20LFBT), and head top

EVAPAN1 PAPR System with 20LF2L loose-fitting facepiece, HE Filter, Single Charger

EVAPAN2 PAPR System with 20LF2L loose-fitting facepiece, HE Filter, No Charger

EVAPAN3 PAPR System with 20LFL loose-fitting facepiece, HE Filter, Single Charger



EVAPAN1

EVA Series Assemblies

PAPRs with Loose-Fitting Facepieces

- Assemblies include blower (EVA1), belt (EVABELT1), battery (EVABAT1), charger (EVASMC1), air flow indicator (PA1AFI), breathing tube (PA20LFBT), and head top with suspension (filter not included)
- PAPR System with loose-fitting facepiece

EVA20LFL with 20LFL loose-fitting facepiece

EVA20LFM with 20LFM loose-fitting facepiece

EVA20LF2L with 20LF2L loose-fitting facepiece

EVA20LF2M with 20LF2M loose-fitting facepiece

EVA20LF2S with 20LF2S loose-fitting facepiece



EVA20LFL

***Add DB suffix to substitute EVABELT1 for decon belt (EVABELT2)**

EVA Series Powered Air-Purifying Respirator

EVA Series Replacement Blowers

EVA1	Blower Unit only
EVA2	Blower, Belt (EVABELT1), Battery (EVABAT1), Charger (EVASMC)
EVA3	Blower, Belt (EVABELT1), Battery (EVABAT1)
EVA4	Blower, Belt (EVABELT1), Battery (EVABAT1), HE Filter (PAPRFC3)
EVA5	Same as EVA2 with EVABAT2 Battery (for masks)
EVA6	Same as EVA3 with EVABAT2 Battery (for masks)
EVA7	Same as EVA4 with EVABAT2 Battery (for masks)



EVA1

EVA Series Replacement Filters and Cartridges

PAPRFC3	HE Filter (6 per package)
PAPRFC4	OVAGHE Filter - Organic vapors, Chlorine, Chlorine Dioxide, Sulfur Dioxide, Hydrogen Chloride, Hydrogen Fluoride, and High Efficiency Particulate (6 per package)
PAPRFC5	Combination Filter, Ammonia, Formaldehyde, Chlorine, Chlorine Dioxide, Sulfur Dioxide, Hydrogen Chloride, Hydrogen Fluoride, Methylamine, High Efficiency Particulate (6 per package)
PAPRFC4ICP	Filter storage cap (3 pack), PAPRFC4 Inlet
PAPRFC4OCP	Filter storage cap (3 pack), PAPRFC3/PAPRFC4 Outlet



MAXXLife Calculator

The ultimate tool for calculating respirator cartridge protection

MAXXLife is a user-friendly calculator that helps measure the service life of combination air-purifying respirator cartridges from Bullard. MAXXLife lets you manage the life of your cartridge. Just follow the step-by-step MAXXLife Calculator program to determine how long you can use your cartridge before it needs to be replaced.

Download it at www.bullard.com



EVA Series Batteries

EVABAT1	Battery (black) for use with hoods and loose-fitting facepieces
EVABAT2	Battery (green) for use with tight-fitting masks



EVABAT1 EVABAT2

EVA Series Chargers

EVASMC	Charger, Single Port
EVASMC2	Charger, Single Port Analyzer
EVASMC AU	EVASMC for Australia
EVASMC EU	EVASMC for Europe
EVASMC UK	EVASMC for United Kingdom
EVAGC	Charger, Six Port Gang
EVASMCPS	Power Supply, EVASMC, EVASMC2, EVAHLSMC, EVAHLSMC2



EVA Series Powered Air-Purifying Respirator

EVA Series Replacement Parts and Accessories

EVABELT1 Belt, closed cell, chemically resistant, combination comfort and decon



EVABELT1

EVABELT2 Belt, closed cell, chemically resistant, vinyl decon



EVABELT2

EVAEXT1 Extender belt



EVAEXT1

PAPRSUSP1 Suspenders, vinyl



PAPRSUSP1

EVALLKIT Lever Lock Kit for EVA Back Plate

PAPRSC2 Decon Shower Cap for EVA HE filter (PAPRFC3)

PAPRSC3 Decon Shower Cap for EVA OVAGHE filters (PAPRFC4, PAPRFC5)

PAPRPF2 Pre-Filter (120 pk) for EVA OVAGHE filters (PAPRFC4, PAPRFC5)

PAPRPFCOVER2 Pre-Filter Cover for EVA OVAGHE filters (PAPRFC4, PAPRFC5)

EVABP1 Back Plate for EVABELT1

EVABP2 Back plate for EVABELT2

EVABUCKLE Replacement buckle for EVABELT1 and EVABELT2



EVABUCKLE

EVACAPBLK Vinyl Storage Cap Black (3 pk)

EVACAPRED Vinyl Storage Cap Red (3 pk)



EVALLKIT



PAPRSC2



PAPRSC3



PAPRPFCOVER2

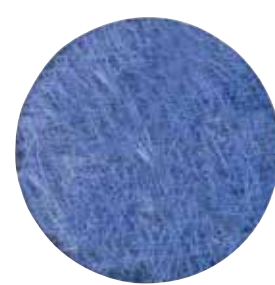

PAPRPF2



EVABP1



EVABP2



EVACAPBLK



EVACAPRED



Powered Air-Purifying Respirators

SparxLift Welding Helmet

Welding Helmet for EVA Powered Air-Purifying Respirator

Powered by the industry leading EVA PAPR blower, the SparxLift system provides the best combination of both face and respiratory protection for welding and grinding in a single package.

Integrated Protection

The SparxLift PAPR combination system provides welders and grinders with NIOSH approved respiratory protection and ANSI/ISEA Z87.1 high impact face protection. Users are protected from airborne hazards when SparxLift is coupled with the EVA PAPR that delivers 8.5 CFM (cubic feet per minute) of airflow and 1,000 Assigned Protection Factor (APF) to the helmet. SparxLift is equipped with a clear panoramic polycarbonate lens to protect users while grinding, and the engineered Nylon Shell provides tough, lightweight, heat resistant protection. The DuPont™ Nomex® shroud completes the protective envelope to cover the remainder of the face and head.

Innovative Design

The SparxLift Welding Helmet features an Auto Darkening Filter (ADF) and unique patented AutoLift design that allows users to quickly switch from welding to grinding with the push of a button. With optically correct Ultraviolet (UV) and Infrared (IR) filters, SparxLift provides users with superior protection and viewing performance. The helmet's ADF reacts to prevent flash in 1/25,000 of a second and UV and IR filters provide full-time protection.

Intuitive Technology

SparxLift Welding is equipped with the patented Inner Sense™ feature, which detects the Radio Frequency (RF) signal produced by Tungsten Inert Gas (TIG) welders to darken the screen before the ark is struck. In addition, SparxLift offers users the added benefit of EVA's features including:

- An Active Flow Technology system that automatically maintains constant air flow regardless of filter type, hood type, filter loading or battery capacity
- Ergonomic single-filter design for quick installation
- Two distinct audible alarms
- Easy-to-read fuel gauge



SPARX LIFT

SparxLift Welding Helmet

Technical Specifications			
Regulatory Standards	ANSI/ISEA Z87.1 EN175 and EN379	Switching Delay (dark to light)	Low: 0.3 - 0.6s Fast: 0.1 - 0.35s
Helmet Weight (without shroud)	19.6 oz (560 grams)	Power Supply	3V Lithium (CR2032)
ADF Window Size	3.9" x 1.8" (97 x 46 mm)	Battery Life	~3,000 hours
Sensors	(2) Dual UV/IR	Supplementary Power	Solar Cells (Auto On/Off)
Switching Time	1/25,000 second (.04 msec)	Indicators	Low Battery
Shade Level	Inactivated Shade #4 Activated Shades #9-#13	Operating Temperature	23°F to 131°F (-5°C to 55°C)
Sensitivity Adjustment	Dual sensors plus pre-shading (low-high)	Storage Temperature	-4°F to 158°F (-20°C to 70°C)

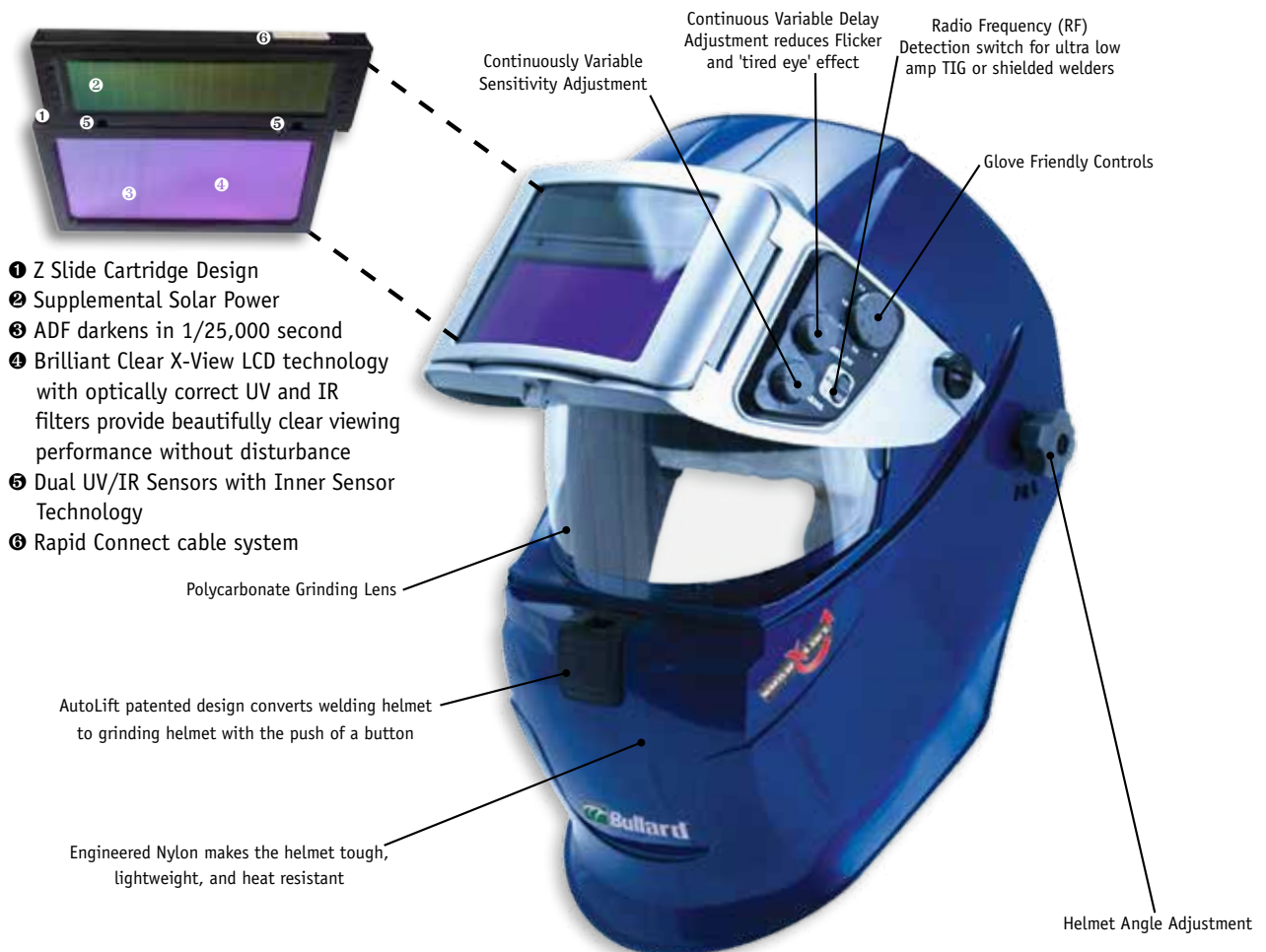

EVA PAPER Blower

Technical Specifications			
Regulatory Standards	NIOSH 42 CFR Part 84 TC-21C-0940 and TC-21C-0941	Battery	Lithium Polymer, 4 cells 14.8V nominal voltage (16.8V peak voltage) 6300 mAh
Blower Weight	1.6 lbs (726 grams)	Motor	Brushless
Battery Weight	1.3 lbs (590 grams)	Filter	High Efficiency Particulate
Assigned Protection Factor	25 APF with SLS1 1,000 APF with SLS2	Operating Temperature	23°F to 131°F (-5°C to 55°C)
Airflow	240/200 lpm (8.5/7.0 CFM) for hi/low speeds	Storage Temperature	23°F to 131°F (-5°C to 55°C)
Alarms	Audible Low Flow Audible Low Battery	Country of Origin	Assembled in the USA with domestic and imported components



Welding Helmet for EVA Powered Air-Purifying Respirator

SparxLift Series Welding Helmet for EVA PAPR Selection Chart

1. SparxLift Helmet



• SLH

2. Choose Shroud



• SLS1 - Loose-Fitting Facepiece Style 25 APF



• SLS2 - Hood Style 1,000 APF

3. Choose Breathing Tube



• PAHBTXL - (32")
• PAHBT - (26")
• PAHBTXS - (22")
Hose Assembly



• PAHBTBK - Hose Assembly for backpack

4. Backpack

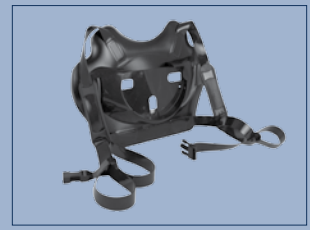

• EVABKPK1 - Backpack

5. Choose Belt



• EVABELT1 - Foam Belt Double Pull Buckle



• EVABELT2 - Vinyl Belt Double Pull Buckle



• EVAEXT1 - Extender Belt

6. FR Cover/Spark Arrest



• EVAFCR1 - FR Cover/Spark Arrest
• EVABPDCFR1 - FR Cover/Spark Arrest for use with HE Filter and Backpack

7. Blower Unit



• EVA1 - EVA, Blower Unit Only
• EVA2 - Blower Battery (EVABAT1), Charger (EVASMC)
• EVA3 - Blower Battery (EVABAT1), Charger (EVASMC), HE Filter (PAPRFC3)

8. Filter



• PAPRFC3 - (HEPA) Package of 6

9. Choose Charger



• EVASMC - Single Port



• EVAGC - Six-Port Gang Charger



• GEVASC2 - Single Port Genius Charger with EVALuator Software

10. Storage Bag



• PAPRBAG - PAPR Storage Bag

SparxLift Series Welding Powered Air-Purifying Respirator

SparxLift Systems

A NIOSH approved EVA Powered Air Purifying Respirator System consists of four components:

- (1) Welding Helmet with Shroud
- (2) Breathing Tube
- (3) HE Filter
- (4) Eva Blower

Approval No. TC-21C-0940
TC-21C-0941



SparxLift Series Assemblies

SparxLift EVA Welding Systems

- Assemblies include blower (EVA1, all black in color) with HE filter (PAPRFC3), belt (EVABELT1), battery (EVABAT1), air flow indicator (PA1AFI), breathing tube (PAHBT), head top (SLH)

EVASL1 Charger (EVASMC) and 25 APF Shroud



EVASL1NC No Charger and 25 APF Shroud



EVASL2 Charger (EVASMC) and 1000 APF Shroud



*Add DB suffix to substitute EVABELT1 for decon belt (EVABELT2)

SparxLift Series Welding Powered Air-Purifying Respirator

SparxLift EVA Replacement Blowers

EVA1	Blower Unit Only
EVA2	Blower Battery (EVABAT1), Charger (EVASMC)
EVA3	Blower Battery (EVABAT1), Charger (EVASMC), HE Filter (PAPRFC3)



EVA1

SparxLift EVA Replacement Belt

EVABELT1	closed cell, chemically resistant, combination comfort and decon
EVABELT2	closed cell, chemically resistant, vinyl decon



EVABELT1

SparxLift EVA Blower Covers

EVADCFR1	Dust Cover with Spark Arrest, FR, for use with HE Filter (PAPRFC3)
EVABPDCFR1	Dust Cover with Spark Arrest, FR, for use with HE Filter (PAPRFC3) and Backpack (EVABKPK1)



EVADCFR1

SparxLift Replacement Shroud

SLS1	25 APF Loose-Fitting Facepiece Style Shroud, Nomex
SLS2	1,000 APF Hood Style Shroud, Nomex



SLS1



SLS2

SparxLift Replacement Helmet

SLH	SparxLift Helmet with ADF and ratchet headgear (no shroud)
------------	--



SLH

SparxLift Replacement Helmet Parts

1. SLSHELLBLU	Helmet Shell, does not include ratchet headgear or knob set
2. SLGL	Inner Protective Lens (Grinding), 3 pack
3. SLRCL	Inside Cover Plate, 5 pack
4. SLADF	Auto Darkening Filter
5. SLPBA	Push Button Assembly
6. SLBAT1	Battery
7. SLFCL	Front Cover Lens, 10 pack
8. SLALA	Auto Lift Assembly (Incl. external ADF controls, mounting kit, push button assembly)
9. SLHCA	Hinge Cap Assembly Kit

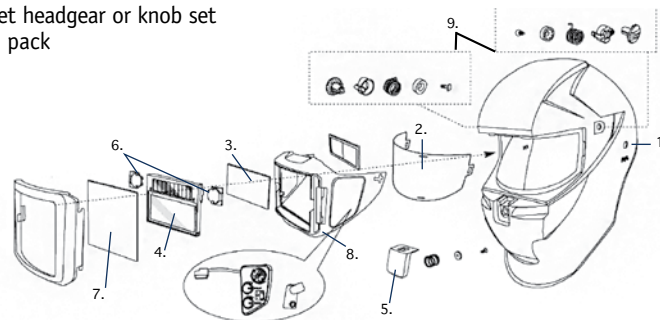

SparxLift Accessories (Not Pictured)

SLCLP	Cover Lens Pack (5 outer, 2 inner lens)
SLHG	Headgear (includes head band and knob set)
SLSBA	Sweat Band Assembly



Guidance for Powered Air-Purifying Respirators (PAPRs) Used in Hazardous Classified Locations

PAPRs are often used in Hazardous Classified Locations, so it is important to understand the regulatory and practical implications. This document provides a brief overview of Hazardous Locations (HazLoc) in general, as well as some specifics with regards to PAPRs.

Overview

A Hazardous Classified Location is an area where fire or explosion hazards exist due to flammable gases or vapors, flammable liquids, combustible dust, or ignitable fibers or flyings.

- Classes: Classes define an area with respect to type of hazard presiding in the area.
- Divisions: Divisions further define an area with respect to whether potentially explosive conditions reside normally or abnormally.
- Groups: Groups further define Class I and Class II areas by the nature of the flammable substances.

Temperature Codes

Because mixtures of hazardous gases and air may ignite in contact with a hot surface, equipment that is certified for hazardous locations receive a temperature code indicating the maximum surface temperature of the equipment. These range from a T6 rating of 185°F (85°C) to a T1 rating of 842°F (450°C). Below is a summary from the National Electric Code (NEC) Articles 501-503 and referenced in OSHA's Hazardous Classified Locations Outreach Training for the Construction Industry.

Summary of Class I, II, III Hazardous Locations			
Class	Group	Division	
		1	2
I Gases, Vapors, Liquids Examples include: Petroleum refineries, spray finishing area, and pharmaceutical manufacturing plants.	A. Acetylene. B. Atmospheres such as butadiene, ethylene oxide, propylene oxide, acrolein, or hydrogen (or gases or vapors equivalent in hazard to hydrogen). C. Atmospheres such as cyclopropane, ethyl ether, ethylene, or gas or vapors of equivalent hazard. D. Atmospheres such as acetone, alcohol, ammonia, benzene, benzol, butane, gasoline, hexane, lacquer solvent vapors, naphtha, natural gas, propane, or gas or vapors of equivalent hazard.	Normally explosive and hazardous.	Not normally present in an explosive concentration (but may accidentally exist).
II Dust Examples include: Grain elevators, flour mills, coal preparation plants, and pharmaceutical manufacturing plants.	E. Metal Dust. Aluminum and magnesium dust and other metal dusts of similar nature. F. Atmospheres containing such materials as carbon black, charcoal dust, coal, and coke dust. G. Grain dust, flour, starch, cocoa, and similar types of materials.	Ignitable quantities of dust normally are or may be in suspension, or conductive dust may be present.	Dust not normally suspended in an ignitable concentration (but may accidentally exist). Dust layers are present.
III Fibers and Flyings Examples include: Textile mills, cotton gins, and saw mills.	H. Textiles, woodworking, etc (easily ignitable, but not likely to be explosive)	Handled or used in manufacturing.	Stored or handled in storage (exclusive of manufacturing).

From OSHA 1910.399 Class I locations. Class I locations are those in which flammable gases or vapors are or may be present in the air in quantities sufficient to produce explosive or ignitable mixtures. Class I locations include the following:

(1) A Class I, Division 1 location is a location:

- (i) In which ignitable concentrations of flammable gases or vapors may exist under normal operating conditions; or
- (ii) In which ignitable concentrations of such gases or vapors may exist frequently because of repair or maintenance operations or because of leakage; or
- (iii) In which breakdown or faulty operation of equipment or processes might release ignitable concentrations of flammable gases or vapors, and might also cause simultaneous failure of electric equipment.

(2) A Class I, Division 2 location is a location:

- (i) In which volatile flammable liquids or flammable gases are handled, processed, or used, but in which the hazardous liquids, vapors, or gases will normally be confined within closed containers or closed systems from which they can escape only in the event of accidental rupture or breakdown of such containers or systems, or as a result of abnormal operation of equipment; or
- (ii) In which ignitable concentrations of gases or vapors are normally prevented by positive mechanical ventilation, and which might become hazardous through failure or abnormal operations of the ventilating equipment; or
- (iii) That is adjacent to a Class I, Division 1 location, and to which ignitable concentrations of gases or vapors might occasionally be communicated unless such communication is prevented by adequate positive-pressure ventilation from a source of clean air, and effective safeguards against ventilation failure are provided.

Guidance for Powered Air-Purifying Respirators (PAPRs) Used in Hazardous Classified Locations

Note to the definition of “Class I, Division 2:” This classification usually includes locations where volatile flammable liquids or flammable gases or vapors are used, but which would become hazardous only in the case of an accident or from some unusual operating condition. The quantity of flammable material that might escape in case of an accident, the adequacy of ventilating equipment, the total area involved, and the record of the industry or business with respect to explosions or fires are all factors that merit consideration in determining the classification and extent of each location.

HazLoc Equipment

Equipment used in Hazloc areas are designed with the prevention of a fire or explosion in mind. There are three ingredients necessary for a fire or explosion: a flammable material (such as the gas, vapor, or dust), an oxidizer (like air or oxygen), and an ignition source (such as a spark or high heat). Equipment designers employ a variety of techniques to prevent their equipment from being an ignition source, from coming in contact with flammable materials, and from coming in contact with oxidizers that can fuel a fire. Enclosures can be designed so that the flammable material stays outside the enclosure, any sparks stay inside the enclosure, and only a limited supply of air (oxidizer) exists within the enclosure. Materials are selected so that a spark isn't generated from friction or impact. Circuits are designed so that electrical sparks are minimized. Further considerations result in designs that limit the temperature rise of the equipment to prevent surface ignition which can occur at the Auto-Ignition Temperature (ATI) or spontaneous ignition temperature at which a hazardous substance will spontaneously ignite without further energy. Finally, design techniques can be taken to limit energy. These protective techniques have names that include explosion proof, dust ignition-proof, dust tight, nonincendive, and intrinsic safety.

PAPR Specifics

PAPRs are typically designed with one of two protective design techniques: nonincendive or intrinsic safety. According to the Fire Protection Handbook, intrinsically safe is defined as "...equipment and wiring incapable of releasing sufficient energy under normal or abnormal conditions to cause ignition of a specific hazardous atmospheric mixture." This protective technique can receive certification for Division 1 environments. Nonincendive equipment is incapable, under normal operating conditions, of causing ignition of a specified flammable gas-air, vapor-air, or dust-air mixture due to arcing or thermal means. This protective technique can receive certification for Division 2 environments.

Certification

There are several factors that determine the type of certification a piece of electrical equipment will receive. For a battery powered device such as a PAPR, the amount of energy in the battery, the operational voltage, the location of battery contacts and the inductance of the motor are all factors. PAPR users often desire features in the blower unit that make achieving the highest hazardous classified location certifications difficult. Higher airflow and longer battery run time require higher levels of energy. Removable batteries, for sharing a blower across shifts, make battery contact design very challenging. At the end of the day the designers must balance the features requested by the customers with the limitations imposed by the certification standards. The implication is that the higher the performance of the PAPR, the less likely the PAPR will be designed with the intrinsic safety protective technique.

Bullard Hazloc PAPR

Bullard has (1) HazLoc PAPR

1. The EVAHL which is certified by CSA for Class I, Div 2, Groups A, B, C, D; Class II, Div 2, Groups F, G; Class III

Key Points to Remember

- Equipment used in any Hazardous Classified Location must match the classification of the location.
- The presence of a flammable substance is not the sole criteria to determine Division 1 or Division 2 designation (see 1910.399).
 - The **concentration** level of the gas/vapor is a key determining factor.
 - The simultaneous failure of electrical equipment is key if the abnormal release of an ignitable concentration is being considered.

Key References

Underwriters Laboratory (UL) North American Protective Techniques Comparison
http://www.ul.com/global/documents/offerings/services/hazardouslocations/CI_protection_methods.pdf

Factory Mutual (FM) Hazardous Locations Resources
<http://www.fmglobal.com/page.aspx?id=50010107>

Canadian Standards Association (CSA) HazLoc Certification in North America
http://www.csa-international.org/product_areas/hazloc_equip/hazloc_for_north_america/

OSHA's Hazardous Classified Locations Outreach Training
<http://www.osha.gov/doc/outreachtraining/htmlfiles/hazloc.html>

Key Regulations

OSHA 29 CFR 1910.399 Subpart S Electrical, Definitions
http://www.osha.gov/pls/oshaweb/owadisp.show_document?p_table=STANDARDS&p_id=9976

OSHA 29 CFR 1910.307 Subpart S Electrical, Hazardous (Classified) Locations
http://www.osha.gov/pls/oshaweb/owadisp.show_document?p_id=9884&p_table=standards

OSHA 29 CFR 1910.134 Subpart I Personal Protection Equipment, Respiratory Protection
http://www.osha.gov/pls/oshaweb/owadisp.show_document?p_table=standards&p_id=12716

EVAHL Powered Air-Purifying Respirator

For Hazardous Locations

Combining the cutting-edge technology and ergonomic design of the EVA, the EVAHL Powered Air-Purifying Respirator (PAPR) offers workers greater protection in Hazardous Locations. The EVAHL is approved for use as part of a NIOSH approved respirator assembly and certified by CSA International for Hazardous Locations Class I, Division 2, Groups A, B, C, D, T6; Class II, Division 2 Groups F, G; and Class III.

All the Great EVA Features...

Now HazLoc Rated

With a HazLoc rating, EVAHL can be used in multiple hazardous locations which may exist due to flammable gases or vapors, flammable liquids, combustible dust, or ignitable fibers or flyings. Equipped with an ergonomic single-filter design, dual speeds, two alarms, and a visual fuel gauge, EVAHL offers advanced technology in a compact, streamlined design.

Safe and Dependable

EVAHL is equipped with an Active Flow Technology system that automatically maintains constant air flow regardless of filter type, hood type, filter loading, or battery capacity. Designed for worker safety, EVAHL features dual alarms for low air flow and low battery and a filter locking tab that notifies users that the filter is properly in place. Its 10,000-hour brushless motor is designed for long-term reliable use providing 10 times the life of most brush motors.

EVAHL can be used with Bullard Dupont™ Tychem® hoods and loose-fitting facepieces. Bullard hoods provide superior protection with a 1,000 Assigned Protection Factor (APF) that is documented by an independent third party.



EVAHL Series Powered Air-Purifying Respirator

EVAHL Systems

A complete EVAHL Series Respirator consists of the following four components:

- (1) Hood or Mask
- (2) Breathing Tube
- (3) EVAHL Blower
- (4) Purifying Filter Cartridge

Approval No. 21C-0922 - Hoods with HE Filter
 23C-2765 - Hoods with OVAGHE Filter
 23C-3097 - Hoods with Combination Filter

All of these components must be present and properly assembled to constitute a NIOSH-approved respirator.



EVAHL Systems

PAPR System with Single Bib Tychem QC Hood

- Assembly includes blower (EVAHL1), belt (EVABELT1), battery (EVAHLBAT1), charger (EVAHLSMC), air flow indicator (PA1AF), breathing tube (PAHBT), and head top with suspension (20RT) (filter sold separately).

EVAHL20TJT with 20TJT Quick-Attach T-Series hood

***Add DB suffix to substitute EVABELT1 for decon belt (EVABELT2)**



EVAHL20TJT

PAPR Systems with Double Bib Tychem® QC Hood

- Assemblies include blower (EVAHL1), belt (EVABELT1), battery (EVAHLBAT1), charger (EVAHLSMC), air flow indicator (PA1AF), breathing tube, and head top (filter sold separately)

EVAHL20TICT with 20TICT Quick-Attach T-Series hood, 20RT suspension, and PAHBT breathing tube

EVAHL20TICS with 20TICS hood (long outer bib, taped seams), 20RT suspension, and PA1BT breathing tube

EVAHL20TICST with 20TICST Quick-Attach T-Series hood (long outer bib, taped seams), 20RT suspension, and PAHBT breathing tube

EVAHLRT3 with RT3 hood (oversized lens and no headband) and PA1BT breathing tube

EVAHLRT3T with RT3T Quick-Attach T-Series hood (oversized lens and no headband) and PAHBT breathing tube

***Add DB suffix to substitute EVABELT1 for decon belt (EVABELT2)**



EVAHL20TICT



EVAHL Series Powered Air-Purifying Respirator

EVAHL Systems

PAPR Systems with Double Bib Hoods and Head Protection

- Assemblies include blower (EVAHL1), belt (EVABELT1), battery (EVAHLBAT1), charger (EVAHLSMC), air flow indicator (PA1AF), breathing tube (PAHBT), and head top with S51R hard hat (filter sold separately).

EVAHL20TICHT with 20TICH Quick-Attach T-Series hood (Tychem® QC)
EVAHL20SICHT with 20SICH Quick-Attach T-Series hood (Tychem® SL)

*Add DB suffix to substitute EVABELT1 for decon belt (EVABELT2)



EVAHL20TICHT

EVAHL Series Assemblies

PAPRs with Double Bib Tychem® SL Hoods

- Assemblies include blower (EVAHL1), belt (EVABELT1), battery (EVAHLBAT1), charger (EVAHLSMC), air flow indicator (PA1AF), breathing tube (PAHBT), and head top.

EVAHL20SICT with 20SICT Quick-Attach T-Series hood (taped seams)
EVAHLRT4T with RT4 Quick-Attach T-Series hood (oversized lens and no headband)

*Add DB suffix to substitute EVABELT1 for decon belt (EVABELT2)



EVAHLRT4T

EVAHL Series Assemblies

Pandemic Preparedness Assemblies

- Assemblies include blower (EVAHL1), belt (EVABELT1), battery, air flow indicator, breathing tube, headtop, and charger (filter sold separately).

EVAHLPAN1 PAPR System with 20LF2L loose-fitting facepiece, HE Filter, Single Charger
EVAHLPAN2 PAPR System with 20LF2L loose-fitting facepiece, HE Filter, No Charger



EVAHLPAN1

EVAHL Series Powered Air-Purifying Respirator

EVAHL Series Assemblies

PAPR System with Loose-Fitting Facepieces

- Assemblies include blower (EVAHL1), belt (EVABELT1), battery (EVAHLBAT1), charger (EVAHLSMC), air flow indicator (PA1AF), breathing tube (PA20LFBT), and head top (filter sold separately).

EVAHL20LFL	with 20LFL loose-fitting facepiece
EVAHL20LFM	with 20LFM loose-fitting facepiece
EVAHL20LF2L	with 20LF2L loose-fitting facepiece
EVAHL20LF2M	with 20LF2M loose-fitting facepiece
EVAHL20LF2S	with 20LF2S loose-fitting facepiece

*Add DB suffix to substitute EVABELT1 for decon belt (EVABELT2)



EVAHL20LFL



EVAHL Series Powered Air-Purifying Respirator

EVAHL Series Replacement Blowers

EVAHL1	Blower unit only
EVAHL2	Blower, Belt (EVABELT1), Battery (EVAHLBAT1), Charger (EVAHLSMC)
EVAHL3	Blower, Belt (EVABELT1), Battery (EVAHLBAT1)
EVAHL4	Blower, Belt (EVABELT1), Battery (EVAHLBAT1), HE Filter (PAPRFC3)



EVAHL4

EVAHL Series Replacement Filters and Cartridges

PAPRFC3	HE Filter (6 per package)
PAPRFC4	OVAGHE Filter - Organic vapors, Chlorine, Chlorine Dioxide, Sulfur Dioxide, Hydrogen Chloride, Hydrogen Fluoride, and High Efficiency Particulate (6 per package)
PAPRFC5	Combination Filter, Ammonia, Formaldehyde, Chlorine, Chlorine Dioxide, Sulfur Dioxide, Hydrogen Chloride, Hydrogen Fluoride, Methylamine, High Efficiency Particulate (6 per package)



PAPRFC3

PAPRFC4
PAPRFC5

MAXXLife Calculator

The ultimate tool for calculating respirator cartridge protection

MAXXLife is a user-friendly calculator that helps measure the service life of combination air-purifying respirator cartridges from Bullard. MAXXLife lets you manage the life of your cartridge. Just follow the step-by-step MAXXLife Calculator program to determine how long you can use your cartridge before it needs to be replaced. Download it at www.bullard.com



EVAHL Series Batteries

EVAHLBAT1	Battery for use with hoods
------------------	----------------------------



EVAHLBAT1

EVAHL Series Chargers

EVAHLSMC	Charger, Single Port
EVAHLSMC2	Charger, Single Port Analyzer
EVAHLSMCAU	EVAHLSMC for Australia
EVAHLSMCEU	EVAHLSMC for Europe
EVAHLSMCAU	EVAHLSMC for United Kingdom
EVAHLSMCPS	Power Supply, EVASMC, EVASMC2, EVAHLSMC, EVAHLSMC2
EVAHLGC	Charger, Six Port Gang, 16x13x4



EVAHLSMC



EVAHLSMC2



EVAHLSMCAU



EVAHLSMCEU



EVAHLSMCAU



EVAHLGC

EVAHL Series Powered Air-Purifying Respirator

EVAHL Series Replacement Parts and Accessories

EVABELT1 Belt, closed cell, chemically resistant, combination comfort and decon



EVABELT1

EVABELT2 Belt, closed cell, chemically resistant, vinyl decon



EVABELT2

EVAEXT1 Extender belt



EVAEXT1

PAPRSUSP1 Suspenders, Vinyl

PAPRSC2 Decon Shower Cap for EVA HE filter (PAPRFC3)

PAPRSC3 Decon Shower Cap for EVA OVAGHE filter (PAPRFC4)

PAPRPF2 Pre-Filter (120 pk) for EVA OVAGHE filter (PAPRFC4)

PAPRPFCOVER2 Pre-Filter Cover for EVA OVAGHE filter (PAPRFC4)



PAPRSUSP1



PAPRSC2



PAPRSC3



PAPRPFCOVER2

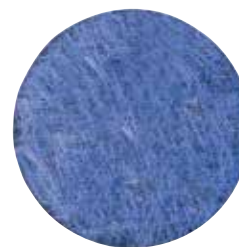

PAPRPF2



PAPR Replacement Head Pieces

Loose-Fitting Facepieces

20LF Series

- Sewn in suspension
- Latex-free
- Quick-attach twist lock connection
- 10 per case

20LFXL Loose-Fitting Facepiece, Extra Large
20LFL Loose-Fitting Facepiece, Large
20LFM Loose-Fitting Facepiece, Medium



20LFL

20LF2 Series

- Narrow Profile
- Sewn In Suspension
- Latex-free
- Quick-attach twist lock connection
- 10 per case

20LF2L Loose-Fitting Facepiece with Narrow Profile, Large - 7 1/2" - 8 1/2" face
20LF2M Loose-Fitting Facepiece with Narrow Profile, Medium - 7" - 7 1/2" face
20LF2S Loose-Fitting Facepiece with Narrow Profile, Small - 6 3/8" - 6 7/8" face



20LF2L

Single Bib Tychem® QC Hoods CC20 Series

20TJ Series

- 9" long bib
- 10 per case

20TJ Tychem® QC Single Bib Hood, Flex-Gear® Ratchet Suspension (20RT)
20TJT Tychem® QC Single Bib Quick-Attach T-Series Hood, Flex-Gear® Ratchet Suspension
20TJN Tychem® QC Single Bib Hood, No Suspension
20TJNT Tychem® QC Single Bib Quick-Attach T-Series Hood, No Suspension





20TJ

Double Bib Tychem® QC Hoods CC20 Series

20TIC Series

- 9" long bib
- 10 per case

 **20TIC** Tychem® QC Double Bib Hood with Inner Bib, Flex-Gear® Ratchet Suspension (20RT)
 **20TICT** Tychem® QC Double Bib Quick-Attach T-Series Hood With Inner Bib, Flex-Gear® Ratchet Suspension (20RT)
20TICN Tychem® QC Double Bib Hood with Inner Bib, No Suspension
20TICNT Tychem® QC Double Bib Quick-Attach T-Series Hood with Inner Bib, No Suspension
20TICNX Tychem® QC Double Bib Hood with Inner Bib, No Suspension, No Lens Tissue
20TICNXT Tychem® QC Double Bib Quick-Attach T-Series Hood With Inner Bib, No Suspension, No Lens Tissue



20TIC

PAPR Replacement Head Pieces

Double Bib Hoods RT Series

RT1/RT2 Series

- Inner Bib
- 20" long outer bib
- Extra-large lens
- No suspension required
- Inflatable Neck Cuff
- 10 per case

RT1	Tychem® QC Double Bib Hood
RT1T	Tychem® QC Double Bib Quick-Attach T-Series Hood
RT2	Tychem® SL Double Bib Hood
RT2T	Tychem® SL Double Bib Quick-Attach T-Series Hood



RT1

RT3/RT4 Series

- Inner Bib
- 20" long outer bib
- Extra-large lens
- No suspension required
- Sport Neck Cuff
- 10 per case

RT3	Tychem® QC Double Bib Hood
RT3T	Tychem® QC Double Bib Quick-Attach T-Series Hood
RT4	Tychem® SL Double Bib Hood
RT4T	Tychem® SL Double Bib Quick-Attach T-Series Hood



RT3

Double Bib Tychem® QC Hoods CC20 Series

Taped and Sealed Seams

20TICS Series

- 19" long outer bib with taped seams
- 10 per case

20TICS	Tychem® QC Double Bib Hood with Taped Seams, Flex-Gear® Ratchet Suspension (20RT)
20TICST	Tychem® QC Double Bib Quick-Attach T-Series Hood with Taped Seams, Flex-Gear® Ratchet Suspension (20RT)
20TICSN	Tychem® QC Single Bib Hood, No Suspension
20TICSNT	Tychem® QC Single Bib Quick-Attach T-Series Hood, No Suspension



20TICS

For use with Hard Hats

20TICH Series

- 9" long outer bib with taped seams
- 10 per case

20TICH	Tychem® QC Double Bib Hood, for use with Bullard Hard Hat (Not Included)
20TICHT	Tychem® QC Double Bib Quick-Attach T-Series Hood, for use with Bullard Hard Hat (Not Included)
20TICHC30R	Tychem® QC Double Bib Hood, with C30R Hard Hat
20TICHTC30R	Tychem® QC Double Bib Quick-Attach T-Series Hood, with C30R Hard Hat
20TICHS51R	Tychem® QC Double Bib Hood, with S51R Hard Hat
20TICHTS51R	Tychem® QC Double Bib Quick-Attach T-Series Hood, with S51R Hard Hat



20TICH



PAPR Replacement Head Pieces

Double Bib Tychem® SL Hoods CC20 Series

20SIC Series

- 19" long outer bib with taped seams
- 5 per case

20SIC	Tychem® SL Double Bib Hood with Taped Seams, Flex-Gear® Ratchet Suspension (20RT)
20SICT	Tychem® SL Double Bib Quick-Attach T-Series Hood with Taped Seams, Flex-Gear® Ratchet Suspension (20RT)
20SICN	Tychem® SL Double Bib Hood with Taped Seams, No Suspension
20SICNT	Tychem® SL Double Bib Quick-Attach T-Series Hood with Taped Seams, No Suspension
20SICNX	Tychem® SL Double Bib Hood with Taped Seams, No Suspension, No Lens Tissue
20SICNXT	Tychem® SL Double Bib Quick-Attach T-Series Hood with Taped Seams, No Suspension, No Lens Tissue



20SIC

Vinyl Lens

20SIC Series

- 19" long outer bib with taped seams
- 5 per case

20SICV	Tychem® SL Double Bib Hood with Taped Seams, Flex-Gear® Ratchet Suspension (20RT)
20SICVT	Tychem® SL Double Bib Quick-Attach T-Series Hood with Taped Seams, Flex-Gear® Ratchet Suspension (20RT)
20SICVN	Tychem® SL Double Bib Hood with Taped Seams, No Suspension
20SICVNT	Tychem® SL Double Bib Quick-Attach T-Series Hood with Taped Seams, No Suspension



20SICV

For use with Hard Hats

20SICH Series

- 9" long outer bib with taped seams
- 5 per case

20SICH	Tychem® SL Double Bib Hood with Taped Seams, for use with Bullard Hard Hats
20SICHT	Tychem® SL Double Bib Quick-Attach T-Series Hood with Taped Seams, for use with Bullard Hard Hats
20SICHC30R	Tychem® SL Double Bib Hood with Taped Seams, includes C30R Hard Hat
20SICHTC30R	Tychem® SL Double Bib Quick-Attach T-Series Hood with Taped Seams, includes C30R Hard Hat
20SICHS51R	Tychem® SL Double Bib Hood with Taped Seams, includes S51R Hard Hat
20SICHTS51R	Tychem® SL Double Bib Quick-Attach T-Series Hood with Taped Seams, includes S51R Hard Hat



20SICH

Vinyl Lens

20SICVH Series

- 19" long outer bib
- 5 per case

20SICVH	Tychem® SL Double Bib Hood with Taped Seams, for use with Bullard Hard Hats
20SICVHT	Tychem® SL Double Bib Quick-Attach T-Series Hood with Taped Seams, for use with Bullard Hard Hats
20SICVHC30R	Tychem® SL Double Bib Hood with Taped Seams, includes C30R Hard Hat
20SICVHTC30R	Tychem® SL Double Bib Quick-Attach T-Series Hood with Taped Seams, includes C30R Hard Hat
20SICVHS51R	Tychem® SL Double Bib Hood with Taped Seams, includes S51R Hard Hat
20SICVHTS51R	Tychem® SL Double Bib Quick-Attach T-Series Hood with Taped Seams, includes S51R Hard Hat



20SICVH

PAPR Replacement Head Pieces

Double Bib Nomex Grinding Hood Polycarbonate Lens

GR50 Series

GRH	Nomex Grinding Hood
GRHT	Nomex Grinding Quick-Attach T-Series Hood
GRHRT	Nomex Grinding Hood with Flex Gear® Ratchet Suspension (20RT)
GRHTRT	Nomex Grinding Quick-Attach T-Series Hood with Flex Gear® Ratchet Suspension (20RT)
GRH30R	Nomex Grinding Hood with C30R Hard Hat
GRHT30R	Nomex Grinding Quick-Attach T-Series Hood with C30R Hard Hat
GRHS51R	Nomex Grinding Hood with S51R Hard Hat
GRHTS51R	Nomex Grinding Quick-Attach T-Series Hood with S51R Hard Hat



GRHRT

Full-Face Masks

Spectrum Series®

PASPECML	Spectrum Series® Full Facepiece - Medium/Large
PASPECS	Spectrum Series® Full Facepiece - Small



PASPECML

Half-Face Masks

FAMB Series

- Silicone
- Includes head straps

FAM2L	Large Half-Mask
FAM2M	Medium Half-Mask
FAM2S	Small Half-Mask



FAM2L



PAPR Replacement Parts and Accessories

PAPR Headpiece Replacement Parts

- 20RT** Adjustable Flex-Gear® Ratchet Headband Suspension
- Poly brow pad
 - Fits head sizes 6½" to 8" (52-64 mm)



- RBPCOTTON** Brow Pad
- Absorbent cotton replacement brow pad
 - Fits all Bullard suspensions
 - Easy, Velcro® design



- RBPVINYL** Brow Pad
- Vinyl replacement brow pad
 - Fits all Bullard suspensions
 - Easy, Velcro® design



- RBPCOOL** Brow Pad
- Polartec replacement brow pad
 - Wicking material moves sweat away from the worker's brow
 - Fits all Bullard suspensions
 - Easy, Velcro® design



- 20NC** Elastic Chinstrap
- For 20TG and 20RT suspensions
 - 10 per package



- 20LCL** Adhesive-Edged Mylar® Lens Covers for use with CC20 Series Hoods
- 25 per package



- 20LCLBP** Same as 20LCL
- Eight packs of 25

- RTLCL** Adhesive-Edged Mylar® Lens Covers for use with RT Series Hoods
- 25 per package



20LCL

RTLCL

PAPR Replacement Parts and Accessories

PAPR Head Protection Replacement Parts

C30R

Hard Hat for use with 20TICH, 20SICH, GRH

- High-density polyethylene shell
- Full-profile, wide-brim
- Accessory slots for attachments
- 6-point Flex-Gear® ratchet suspension (RS6RC) with large, absorbent cotton brow pad (RBPCOTTON)
- Replacement brow pads available (RBPCOTTON, RBPVINYL, RBPCOOL)
- Meets or exceeds ANSI/ISEA Z89.1-2014, Type I, Class E & G requirements and CSA Z94.1-2005, Type 1, Class E & G requirements



S51R

Hard Hat for use with 20TICH, 20SICH, GRH

- High-density, polyethylene shell with flat front, low-profile design
- Accessory slots for cap attachments
- Rain trough brim
- 4-point Flex-Gear® ratchet suspension (RS4RC) with replacement cotton brow pad (RPCOTTON)
- Replacement brow pads available (RBPCOTTON, RBPVINYL, RBPCOOL)
- Meets or exceeds ANSI/ISEA Z89.1-2014, Type I, Class E & G requirements and CSA Z94.1-2005, Type 1, Class E & G requirements, and EN 397:2012 requirements



PAPR Replacement Parts and Accessories

PAPR Head Protection Replacement Parts

RS6RC

6-pt. Suspension

- 6-point Flex-Gear® ratchet suspension
- Large, absorbent cotton brow pad
- Replacement brow pads available (RBPCOTTON, RBPVINYL, RBPCOOL)
- Flex-points and nape cushion
- Large, easy-to-turn ratchet knob
- Vertical height adjustments (two front, three rear)
- For Models C30

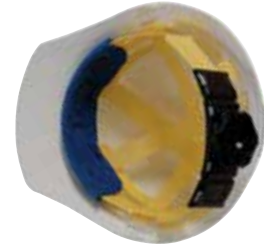

RS4RC

4-pt. Suspension

- 4-point Flex-Gear® ratchet suspension
- Large, absorbent cotton brow pad
- Replacement brow pads available (RBPCOTTON, RBPVINYL, RBPCOOL)
- Flex-points and nape cushion
- Large, easy-to-turn ratchet knob
- For Models S51



ES42

2-Point Elastic Chinstrap, Natural

- Latex-free, natural elastic
- For Models S51, C30



PAPR Replacement Parts and Accessories

Breathing Tubes for CC20 Loose-Fitting Facepieces

- PA20LFBT** Regular Length - 32" Long
- PA20LFBTXS** Extra Small Length - 26" Long
- PA20LFBTXL** Extra Large Length - 38" Long



PA20LFBT

Breathing Tubes for CC20, RT Hoods, and Sparxlift

- PAHBT** Threaded, Regular Length - 26" Long
- PAHBTXS** Threaded, Extra Small Length - 22" Long
- PAHBTXL** Threaded, Extra Large Length - 32" Long

- PA1BT** Regular Length - 26" Long
- PA1BTXS** Extra Small Length - 22" Long
- PA1BTXL** Extra Large Length - 32" Long



PAHBT



PA1BT

Breathing Tubes for Spectrum Series® Full Face Masks

- PA4BT** Regular Length - 33" Long



Breathing Tubes for FAMB Half-Face Masks

- PAFAMBT** Regular Length - 33" Long



PAPR Replacement Parts and Accessories

Breathing Tube Seals

PA1BTS4 Breathing Tube Seal, package of 4



PA1BTS4

Breathing Tube Covers

20QCBTC Tychem® QC Breathing Tube Cover
• Length 24.5"
• 1 each



20QCBTC

20SLBTC Tychem® SL Breathing Tube Cover
• Length 24.5"
• 1 each



POLYBTC

POLYBTC Clear Poly Breathing Tube Cover Sleeve
• Length 38"
• 100 per package



NMXBTC

NMXBTC Nomex Breathing Tube Cover

PAPR Storage Bags

PAPRBAG PAPR Storage Bag
• Green vinyl construction
• 22" long
• Includes shoulder strap
• PAPR not included

PAPRBAG



PPEBAG Storage Bag
• Large black rolling duffel
• 11" wide x 13" tall x 25" long
• Includes shoulder strap

PPEBAG



PAPR Air Flow Indicators

PA1AFI For Hoods
PA4AFI For Masks



PA1AFI

Supplied Air Respirators (SARs)

What is a Supplied Air Respirator?

Supplied Air Respirators deliver breathable air to the worker from a clean air source. The air can come from a variety of sources including high-pressure compressors, low-pressure pumps, or bottled air cylinders. In addition, Supplied Air Respirators can be configured with a variety of head tops including loose-fitting hoods, loose-fitting facepieces, helmets or tight-fitting masks (full and half).

Supplied Air Respirator Advantages

There are many advantages to utilizing a Bullard Supplied Air Respirator System, including the ability to protect against a wide array of contaminants without any filter cartridges to purchase or replace. In addition, most Bullard Supplied Air Respirators can be configured with heating/cooling tubes to increase worker comfort by as much as 40° Fahrenheit (22° Celsius). Finally, Bullard offers a large selection of available head tops, including loose-fitting hoods and helmets, that do not require fit testing.



Supplied Air Respirators (SARs)

Configuring a Supplied Air Respirator System

There are many choices to make when piecing together various components of a Supplied Air Respirator System. The following steps may help simplify this intimidating task:

1.



Choose Air Source (Free-Air® Pump or Compressor)

2.



Choose Head Top

3.



Choose Suspension and/or Hard Hat

4.



Choose Breathing Tube

5.



Choose Flow Control

6.



Choose Hose and Length

7.



Choose Accessories

Supplied Air Fitting Guide

The couplings pictured below are the most popular styles used on airline respirators. A coupling, which is made up of a socket (or nipple) and a plug (or coupler), is also called a "QD" fitting or just "fitting" and comes in various socket (female) and plug (male) sizes. Couplings can have male, female, or hose barb ends for different types of connections.

Industrial Interchange/Hansen-Compatible

Snap-Tite - Also known as Foster; "short and stubby"

Schrader - Looks like a bullet; turn the sleeve to release

CEJN - Similar to Hansen; two hands must be used to disconnect

Bayonet - Long and skinny with pins on the side; no ball bearings to trap grit. Popular with abrasive blasters

Dynaswivel® - Swivels in two axes to keep from kinking

Quick-Disconnect Nipples

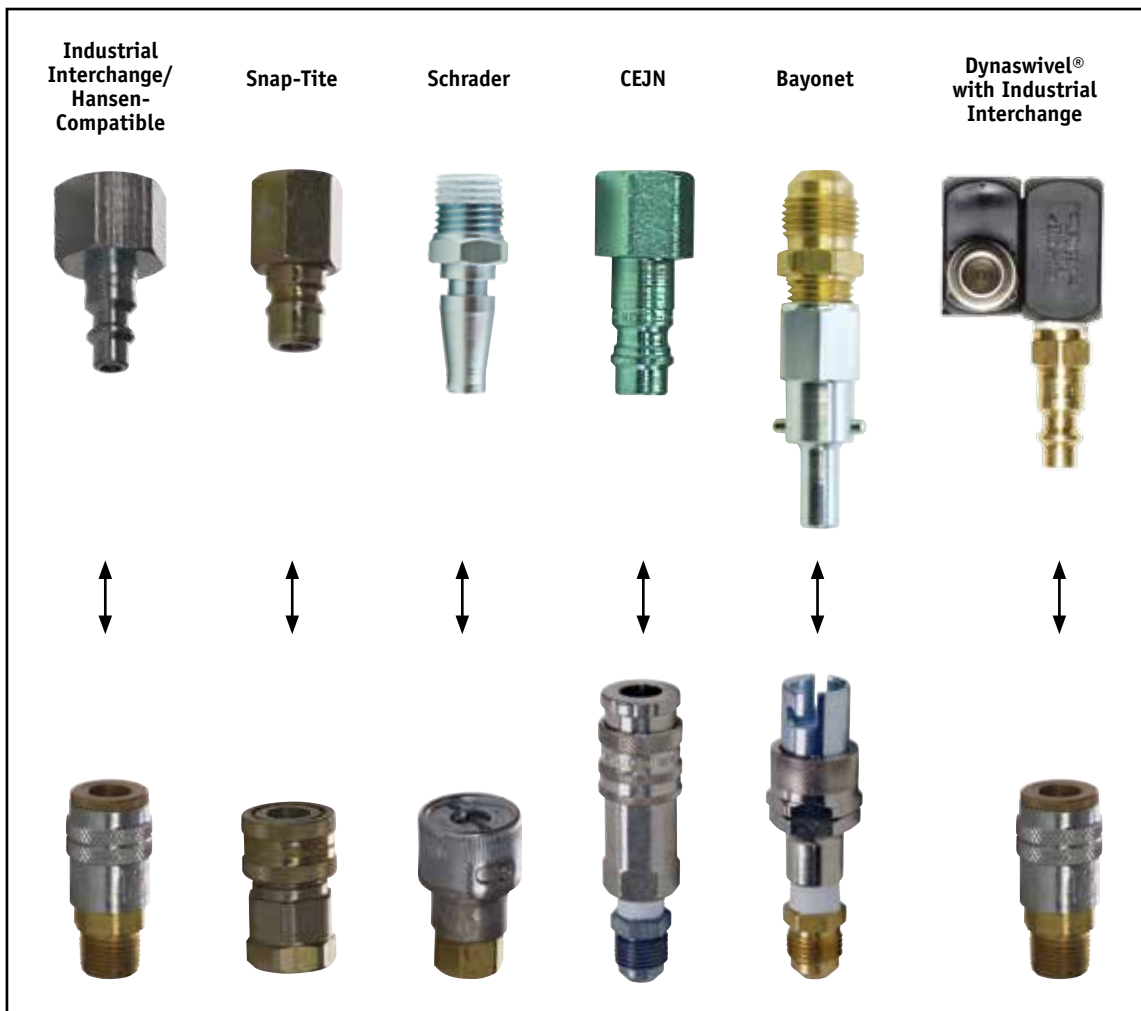

Quick-Disconnect Couplers

CC20 Series Airline Respirator

Simple, Effective, Ultra-Light

The CC20 Series Tychem® hoods provide a wide variety of simple, effective, and economical options for on-the-job respiratory protection. The result is better protection, improved productivity, and greater comfort that combines to produce the best value on the market. These hoods are available for use in a CC20 Series Airline Respirator configuration or Powered Air-Purifying Respirator configuration. These hoods are approved in Type C respirator applications as part of a NIOSH-approved respirator system.

Proven Performance

In a series of 3rd party, independent test the CC20 Series Double Bib Hoods were found to have the highest protection factors of the hoods tested from the pharmaceutical industry with all measurements above 150,000. This series of tests was cited in OSHA's final rule on Assigned Protection Factors (APFs) as the type of Simulated Workplace Protection Factor (SWPF) study that would provide the evidence acceptable for an APF of 1,000.

For a summary of this research, call Bullard Customer Service at 1-877-BULLARD (285-5273) or +1-859-234-6616.

Unique Air Delivery System

A patented neck cuff design helps maintain positive pressure inside the hood to aid in keeping contaminants out. As air enters the hood, the inner collar inflates, providing a snug, comfortable fit around the neck and continuous flow of air to the worker's breathing zone.

Lightweight, Comfortable, and Economical

CC20 Series hoods are lighter and more comfortable than tight-fitting full-facepiece respirators. Covering the entire head, face, and neck, the hood provides splash and overspray protection and makes clean-up quick and easy.

A wide angle lens offers the largest field of vision among Tychem® hood-style respirators on the market, optimizing worker productivity and safety.

Available in a variety of styles, the hood is constructed of either DuPont™ Tychem® QC or Tychem® SL (Saranex), depending on the job application. Taped and sealed seams are also available to provide additional protection for liquid penetration encountered on the job or during decontamination.

No Fit Testing

The hood requires neither fit testing nor extensive record keeping. It easily accommodates beards, prescription eyewear, or safety glasses.

Powered Air or Supplied Air

This hood series is available for use as a Supplied Air Respirator (CC20 Series) or Powered Air Purifying Respirator (EVA and EVAHL Series). The CC20 is a versatile hood suitable for almost any application.



CC20 Series Airline Respirator

CC20 Series Airline Respirator Selection Chart

1. Choose Head Top



• **20TJN** - Tychem® QC Single Bib Hood



• **20TICN** - Tychem® QC Double Bib Hood



• **20SICN** - Tychem® SL Double Bib Hood with Taped Seams
• **20TICSN** - Tychem® QC Double Bib Hood with Taped Seams



• **20SICH** - Tychem® SL Double Bib Hood with Taped Seams, for Hard Hats
• **20TICH** - Tychem® QC Double Bib Hood for Hard Hats

2. Choose Head Top



• **20RT** - Adjustable Ratchet Headband Suspension



• **C30R** - With 6-point Flex-Gear® Ratchet Suspension
For 20SICH, 20TICH, GRH



• **S51R** - With 4-point Flex-Gear® Ratchet Suspension
For 20SICH, 20TICH, GRH

3. Choose Breathing Tube



• **20BT** - Breathing Tube for Hoods

4. Choose Flow Control Device



1/4" Continuous Flow
• **F30, F30B, F30S** - Industrial Interchange
• **F31** - Schrader
• **F32** - Snap-Tite Steel
• **F33** - Snap-Tite Brass
• **F34** - Snap-Tite Stainless
• **F37** - CEJN

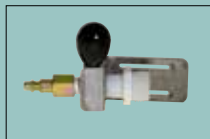

1/4" Adjustable Flow
• **F40, F40B, F40S** - Industrial Interchange
• **F41** - Schrader
• **F42** - Snap-Tite Steel
• **F43** - Snap-Tite Brass
• **F44** - Snap-Tite Stainless
• **F47** - CEJN

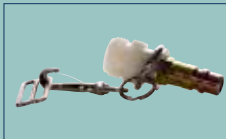

1/2" Continuous Flow for Free-Air® Pumps
• **F35, F35B** - Industrial Interchange



Cool Tubes for Compressed Air
• **AC100030, AC100030B, AC100030S** - 1/4" Industrial Interchange
• **AC100031** - Schrader
• **AC100032** - Snap-Tite Steel
• **AC100033** - Snap-Tite Brass
• **AC100034** - Snap-Tite Stainless
• **AC100037** - CEJN



Cool Tubes for Free-Air® Pumps
• **FRIGITRON2000** - 1/2" Industrial Interchange
• **FRIGITRON2000B** - Brass

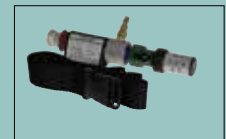

Hot/Cold Tubes
• **HC240030, HC240030B, HC240030S** - 1/4" Industrial Interchange
• **HC240031** - Schrader
• **HC240032** - Snap-Tite Steel
• **HC240033** - Snap-Tite Brass
• **HC240034** - Snap-Tite Stainless
• **HC240037** - CEJN

5. Choose Cooling Vest System



• **DC70ML** - Med/Lg Cool Vest
• **DC70LXXL** - XL/XXL Cool Vest
• **DC705X** - 5XL Cool Vest



• **DC5040, DC5040B, DC5040S** - Dual-Cool Industrial Interchange
• **DC5041** - Dual-Cool Schrader
• **DC5042** - Dual-Cool Snap-Tite Steel
• **DC5043** - Dual-Cool Snap-Tite Brass
• **DC5044** - Dual-Cool Snap-Tite Stainless Steel
• **DC5047** - Dual-Cool CEJN

6. Choose Belt and/or Accessories



• **4612** - Nylon Belt



• **36501** - Decon Belt



• **20NC** - Chinstrap for Hoods

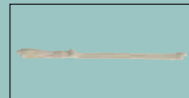

• **ES42** - Chinstrap For Hard Hats

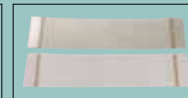

• **20LCL** - Lens Covers

CC20 Series Airline Respirator

CC20 Systems

A complete CC20 Series Airline Respirator consists of the following three components:

1. Respirator Hood with suspension
2. Breathing Tube with Flow Control Device
3. Breathing Air Supply Hose

All of these components must be present and properly assembled to constitute a NIOSH-approved respirator.

Approval No. TC-19C-154

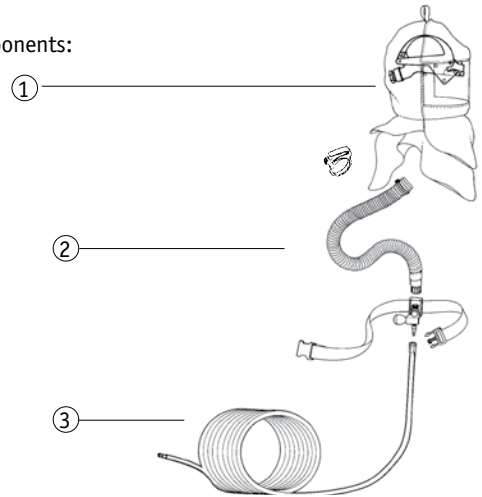

CC20 Series Constant Flow Respirator Systems for Use with Compressed Air

CC20TJ30

Tychem® QC Single Bib Hood System

- 20TJ hood with Flex-Gear® Ratchet Suspension (20RT)
- V30 breathing tube assembly with F30 1/4" Industrial Interchange (Hansen compatible) nipple
- 4612 nylon belt



CC20TJ30

CC20TIC30

Tychem® QC Double Bib Hood System

- 20TIC hood with Flex-Gear® Ratchet Suspension (20RT)
- V30 breathing tube assembly with F30 1/4" Industrial Interchange (Hansen compatible) nipple
- 4612 nylon belt



CC20TIC30

 Best Seller

CC20 Series Airline Respirator

CC20 Series Constant Flow Respirator Systems for use with Compressed Air

CC20TICH30

Tychem® QC Double Bib Hood System for use with Bullard Hard Hat

- 20TICH hood
- Bullard Model C30R hard hat with 6-point Flex-Gear® ratchet suspension (RS6RC)
- V30 breathing tube assembly with F30 1/4" Industrial Interchange (Hansen compatible) nipple
- 4612 nylon belt



CC20TICH30

CC20SIC30

Tychem® SL Double Bib Hood System with Taped Seams

- 20SIC hood with Flex-Gear® Ratchet Suspension (20RT)
- V30 breathing tube assembly with F30 1/4" Industrial Interchange (Hansen compatible) nipple
- 4612 nylon belt



CC20 Series Airline Respirator

CC20 Series Constant Flow Respirator Systems for use with Clean-Air Box

- CC20CABSYS** One-Worker Respirator System
- CC20TIC30 respirator assembly
 - CAB15HA
 - 4696100 air supply hose
 - 20LCL lens covers (One pack of 25)
 - AC1000

- CC20CABSYS2M** Two-Worker Respirator System
- (2) CC20TIC30
 - CAB30IRHA
 - (2) 469100 air supply hose
 - 20LCL lens covers (One pack of 25)
 - (2) AC1000



CC20CABSYS

CC20 Series Constant Flow Respirator Systems for use with Free-Air® Pumps

- CC20SYS** One-Worker Respirator System
- CC20TIC35 respirator assembly
 - EDP10 Free-Air® pump
 - V20100ST 100' air supply hose
 - 20LCL lens covers (One pack of 25)

- CC20SYS50** Same as CC20SYS above except with V2050ST 50' hose

- CC20SYS2M** Two-Worker Respiratory System
- (2) CC20TIC35 respirator assembly
 - EDP16TE Free-Air® pump
 - (2) V20100ST 100' air supply hose
 - 20LCL lens covers (One pack of 25)



CC20SYS

- CC20TIC35** Tychem® QC Double Bib Hood System
- 20TIC hood with Flex-Gear® Ratchet Suspension (20RT)
 - V35 breathing tube assembly with F35 1/2" Industrial Interchange (Hansen compatible) nipple
 - 4612 nylon belt

- CC20TICH35** Tychem® QC Double Bib Hood System with hard hat
- 20TICH hood
 - Bullard Model C30R hard hat with 6-point Flex-Gear® ratchet suspension (RS6RC)
 - V35 breathing tube assembly with F35 1/2" Industrial Interchange (Hansen compatible) nipple
 - 4612 nylon belt

- CC20LF35** Tychem® QC Loose-Fitting Facepiece System
- 20LFL loose-fitting facepiece with sewn in suspension
 - X35 breathing tube assembly with 1/2" Industrial Interchange (Hansen compatible) nipple
 - 4612 nylon belt



CC20TIC35

CC20 Series Airline Respirator Replacement Hoods

Single Bib Tychem® QC Hoods-CC20 Series

20TJ Series

- 10 per case
- 9" long bib

20TJ
20TJN

Tychem® QC Single Bib Hood, Flex-Gear® Ratchet Suspension (20RT)
Tychem® QC Single Bib Hood, No Suspension



20TJ

Double Bib Tychem® QC Hoods

20TIC Series

- 10 per case
- 9" long outer bib

 **20TIC**
20TICN
20TICNX

Tychem® QC Double Bib Hood with Inner Bib, Flex-Gear® Ratchet Suspension (20RT)
Tychem® QC Double Bib Hood with Inner Bib, No Suspension
Tychem® QC Double Bib Hood with Inner Bib, No Suspension, No Lens Tissue



20TIC

 Best Seller



CC20 Series Airline Respirator Replacement Hoods

Double Bib Tychem® QC Hoods

Taped and Sealed Seams

20TICS Series

- 10 per case
- 19" long outer bib

20TICS

Tychem® QC Double Bib Hood with Taped Seams, Flex-Gear® Ratchet Suspension (20RT)

20TICSN

Tychem® QC Double Bib Hood with Taped Seams, No Suspension

20TICS



For use with Hard Hats

20TICH Series

- 5 per case
- 9" long outer bib

20TICH

Tychem® QC Double Bib Hood for use with Bullard Hard Hat (Not Included)

20TICH30R

Tychem® QC Double Bib Hood, Includes C30R Hard Hat

20TICH51R

Tychem® QC Double Bib Hood, Includes S51R Hard Hat

20TICH



CC20 Series Airline Respirator

Double Bib Tychem® SL (Saranex) Hoods CC20 Series

20SIC Series

- 10 per case
- 19" long outer bib

20SIC

Tychem® SL Double Bib Hood with Taped Seams, Flex-Gear® Ratchet Suspension (20RT)

20SICN

Tychem® SL Double Bib Hood with Taped Seams, No Suspension

20SIC



CC20 Series Airline Respirator

For use with Hard Hats

20SIC Series

- 5 per case
- 9" long outer bib

20SICH

Tychem® SL Double Bib Hood with Taped Seams, Hard Hat not included



20SICH



Supplied Air Respirators

CC20 Series Airline Respirator

CC20 Series Headpiece Replacement Parts

- 20RT** Adjustable Flex-Gear® Ratchet Headband Suspension
- Poly brow pad
 - Fits head sizes 6 1/2 to 8 (52-64 mm)



- RBPCOTTON** Brow Pad
- Absorbent cotton replacement brow pad
 - Fits all Bullard suspensions
 - Easy, velcro design



- RBPVINYL** Brow Pad
- Vinyl replacement brow pad
 - Fits all Bullard suspensions
 - Easy, velcro design



- RBPCOOL** Brow Pad
- Polartec replacement brow pad
 - Wicking material moves sweat away from the worker's brow
 - Fits all Bullard suspensions
 - Easy, velcro design



- 20NC** Elastic Chinstrap
- For 20TG and 20RT suspensions
 - 10 per package



- 20LCL** Adhesive-Edged Mylar® Lens Covers
- 25 per package
- 20LCLBP** Same as 20LCL
- Eight packs of 25



20LCL

CC20 Series Airline Respirator

CC20 Head Protection

C30R

Hard Hat for use with 20TICH, 20SICH, GRH

- High-density polyethylene shell
- Full profile, wide brim
- Accessory slots for attachments
- 6-point Flex-Gear® ratchet suspension (RS6RC) with, absorbent cotton brow pad (RBPCOTTON)
- Replacement brow pads available (RBPCOTTON, RBPVINYL, RBPCOOL)
- Meets or exceeds ANSI/ISEA Z89.1-2014, Type I, Class E & G requirements and CSA Z94.1-2005, Type 1, Class E & G requirements



S51R

Hard Hat for use with 20TICH, 20SICH, GRH

- High-density, polyethylene shell with flat front, low-profile design
- Accessory slots for cap attachments
- Rain trough brim
- 4-point Flex-Gear® ratchet suspension with absorbent cotton brow pad (RBPCOTTON)
- Replacement brow pads available (RBPCOTTON, RBPVINYL, RBPCOOL)
- Meets or exceeds ANSI/ISEA Z89.1-2014, Type I, Class E & G requirements and CSA Z94.1-2005, Type 1, Class E & G requirements, and EN 397 requirements



CC20 Series Airline Respirator

CC20 Head Protection Replacement Parts

RS6RC

6-pt. Suspension

- 6-point Flex-Gear® ratchet suspension
- Absorbent cotton brow pad
- Replacement brow pads available (RBPCOTTON, RBPVINYL, RBPCOOL)
- Flex-points and nape cushion
- Large, easy-to-turn ratchet knob
- Vertical height adjustments (two front, three rear)
- For Models C30

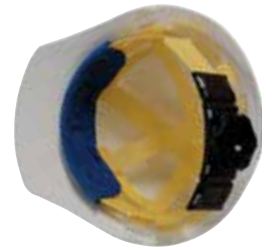

RS4RC

4-pt. Suspension

- 4-point Flex-Gear® ratchet suspension
- Absorbent cotton brow pad
- Replacement brow pads available (RBPCOTTON, RBPVINYL, RBPCOOL)
- Flex-points and nape cushion
- Large, easy-to-turn ratchet knob
- For Models S51



ES42

2-Point Elastic Chinstrap, Natural

- Latex-free, natural elastic



CC20 Series Airline Respirator

CC20 Series Breathing Tube Assemblies for Hoods

Constant Flow Assemblies

- Assemblies include breathing tube (20BT), nylon belt (4612), and clamp (S18051)

- V30**
- With F30 1/4" Industrial Interchange (Hansen compatible) quick-disconnect nipple
 - For use with compressed air



- V31**
- With F31 1/4" Schrader quick-disconnect nipple
 - For use with compressed air



- V32**
- With F32 1/4" Snap-Tite steel quick-disconnect nipple
 - For use with compressed air



- V33**
- With F33 1/4" Snap-Tite brass quick-disconnect nipple
 - For use with compressed air



- V35**
- With F35 1/2" Industrial Interchange (Hansen compatible) quick-disconnect nipple
 - For use with Bullard Free-Air® or ICE pumps



Adjustable Flow Assemblies

- V40**
- With F40 1/4" Industrial Interchange (Hansen compatible) quick-disconnect nipple
 - For use with compressed air



- V41**
- With F41 1/4" Schrader quick-disconnect nipple
 - For use with compressed air



- V42**
- With F42 1/4" Snap-Tite steel quick-disconnect nipple
 - For use with compressed air



- V43**
- With F43 1/4" Snap-Tite brass quick-disconnect nipple
 - For use with compressed air



Air supply hose options

pp. 194-197

Heating and cooling options

pp. 201-206

CC20 Series Airline Respirator

CC20 Series Breathing Tube Replacement Parts

F30 Series Flow Controls

- 1/4" Industrial Interchange (Hansen compatible) quick-disconnect nipple
- Threaded hose connector
- For use with compressed air

F30	Constant Flow Control Fitting with Nylon Belt (4612)
F30VDB	Constant Flow Control Fitting with Vinyl Decon Belt (36501)
F30B	Constant Flow Control Fitting, Brass with Nylon Belt (4612)
F30S	Constant Flow Control Fitting, Stainless Steel with Nylon Belt (4612)
F30SD	Constant Flow Control Fitting, Stainless Steel with Decon Belt (36501)



F30

F31	Constant Flow Control Fitting
	• Same as F30 with 1/4" Schrader quick-disconnect nipple



F32	Constant Flow Control Fitting
	• Same as F30 with 1/4" Snap-Tite steel quick-disconnect nipple



F33	Constant Flow Control Fitting
	• Same as F30 with 1/4" Snap-Tite brass quick-disconnect nipple



F34	Constant Flow Control Fitting
	• Same as F30 with 1/4" Snap-Tite stainless steel quick-disconnect nipple





CC20 Series Airline Respirator

CC20 Series Breathing Tube Replacement Parts

- F35** Constant Flow Control Fitting, Steel
- Same as F30 with 1/2" Industrial Interchange (Hansen compatible) quick-disconnect nipple
 - For use with Bullard Free-Air® and ICE pumps



- F35B** Constant Flow Control Fitting, Brass
- Same as F30 with 1/2" Industrial Interchange (Hansen compatible) quick-disconnect nipple
 - For use with Bullard Free-Air® and ICE pumps Industrial Interchange



F35

- F37** Constant Flow Control Fitting
- Same as F30 with 1/4" CEJN quick-disconnect nipple



F40 Series Flow Controls

- 1/4" Industrial Interchange (Hansen compatible) quick-disconnect nipple
- Threaded hose connector
- For use with compressed air

- F40** Adjustable Flow Control Fitting, Steel, Nylon Belt (4612)
- F40VDB** Adjustable Flow Control Fitting, Vinyl Decon Belt (36501)
- F40B** Adjustable Flow Control Fitting, Brass, Nylon Belt (4612)
- F40S** Adjustable Flow Control Fitting, Stainless Steel, Nylon Belt (4612)

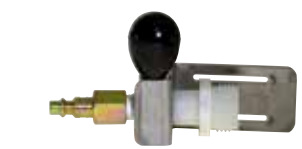

F40

- F41** Adjustable Flow Control Fitting
- Same as F40 with 1/4" Schrader quick-disconnect nipple
 - Nylon belt



CC20 Series Airline Respirator

CC20 Series Breathing Tube Replacement Parts

F42

Adjustable Flow Control Fitting

- Same as F40 with 1/4" Snap-Tite steel quick-disconnect nipple



F43

Adjustable Flow Control Fitting

- Same as F40 with 1/4" Snap-Tite brass quick-disconnect nipple



F44

Adjustable Flow Control Fitting

- Same as F40 with 1/4" Snap-Tite stainless steel quick-disconnect nipple



F47

Adjustable Flow Control Fitting

- Same as F40 with 1/4" CEJN quick-disconnect nipple





CC20 Series Airline Respirator

CC20 Series Breathing Tube Replacement Parts

20BT Breathing Tube for Hoods
 • Flow control not included
 • S18051 clamp



20LFBT Breathing Tube for Loose-Fitting Facepieces
 • Flow control not included



S18051 Breathing Tube Clamp
 • 10 per package



S18051BLACK Breathing Tube Clamp, Black
 • 10 per package



4612 Nylon Belt



36501 Vinyl Decon Belt



20QCBTC Tychem® QC Breathing Tube Cover
 • Length 24.5"
 • 1 each



20QCBTC

20SLBTC Tychem® SL Breathing Tube Cover
 • Length 24.5"
 • 1 each

POLYBTC Clear Poly Breathing Tube Cover Sleeve
 • Length 38"
 • 100 per package



Supplied Air Respirators

20LF Series Loose-Fitting Facepiece

Lightweight, Comfortable Protection

The Bullard Loose-Fitting Facepiece provides comfortable, affordable, and effective protection from a wide range of respiratory hazards. Available for use with supplied air or an EVA Series Powered Air-Purifying Respirator, this loose-fitting facepiece, constructed of DuPont™ Tychem® QC, provides its users with versatility, advanced features, and ease of use. The Bullard Loose-Fitting Facepiece is approved for use as part of a NIOSH approved respirator assembly. The Loose-Fitting Facepiece is used in a wide variety of applications including:

- Pharmaceutical Manufacturing
- General Industry
- General Maintenance
- Woodworking
- Spray Foam
- Painting/Powder Coating
- Healthcare Workers

Features and Benefits

The Loose-Fitting Facepiece utilizes a unique soft plenum design to deliver air to the worker's breathing zone. As air enters the facepiece from the twist-lock breathing tube connection, the soft plenum inflates on the top of the head. The air is then directed down through an opening at the top of the facepiece directly into the worker's breathing zone. Unlike other loose-fitting facepieces, this design provides more airflow where it is most needed and helps to prevent fogging of the lens or drying of the eyes.

Latex-Free Construction

Bullard Loose-Fitting Facepieces are completely latex-free, eliminating any concern over latex sensitivities. The facial seal material is a unique engineered material that is 100% latex-free.

Built-in Suspension

The sewn-in soft suspension provides a comfortable fit to the worker's head, while allowing for complete disposability of the facepiece. This feature also allows for the facepiece to be easily donned/removed with no assembly required.

Twist-Lock Breathing Tube Connection

The twist-lock breathing tube connection provides ease of use by allowing quick connection or disassembly of the breathing tube whether on or off the worker's head.

Wide Angle Lens

The Bullard Loose-Fitting Facepiece features the largest lens available. This gives the worker a wide panoramic field of vision, virtually eliminating the "closed-in" feeling of many respirators.

Climate Control Option

When used as an airline respirator, the Loose-Fitting Facepiece may be used with optional climate control devices. This allows workers to heat or cool incoming air by as much as 40°F (22°C) to improve comfort and enhance productivity.



20LF Loose-Fitting Facepiece

20LF Loose-Fitting Facepiece Chart

1. Choose Head Top



- **20LFM** - Loose-Fitting Facepiece, Medium
- **20LFL** - Loose-Fitting Facepiece, Large



- **20LF2S** - Loose-Fitting Facepiece, Narrow Profile
- **20LF2M** - Loose-Fitting Facepiece, Narrow Profile
- **20LF2L** - Loose-Fitting Facepiece, Narrow Profile

2. Choose Breathing Tube



- **20LFBT** - Breathing Tube for Hoods

3. Choose Flow Control Device



1/4" Continuous Flow

- **F30, F30B, F30S** - Industrial Interchange
- **F31** - Schrader
- **F32** - Snap-Tite Steel
- **F33** - Snap-Tite Brass
- **F34** - Snap-Tite Stainless
- **F37** - CEJN



1/4" Adjustable Flow

- **F40, F40B, F40S** - Industrial Interchange
- **F41** - Schrader
- **F42** - Snap-Tite Steel
- **F43** - Snap-Tite Brass
- **F44** - Snap-Tite Stainless
- **F47** - CEJN



1/2" Continuous Flow for Free-Air®Pumps

- **F35, F35B** - Industrial Interchange



Cool Tubes for Compressed Air

- **AC100030, AC100030B, AC100030S** - 1/4" Industrial Interchange
- **AC100031** - Schrader
- **AC100032** - Snap-Tite Steel
- **AC100033** - Snap-Tite Brass
- **AC100034** - Snap-Tite Stainless
- **AC100037** - CEJN



Cool Tubes for Free-Air® Pumps

- **FRIGITRON2000** - 1/2" Industrial Interchange
- **FRIGITRON200B** - Brass



Hot/Cold Tubes

- **HC240030, HC240030B, HC240030S** - 1/4" Industrial Interchange
- **HC240031** - Schrader
- **HC240032** - Snap-Tite Steel
- **HC240033** - Snap-Tite Brass
- **HC240034** - Snap-Tite Stainless
- **HC240037** - CEJN

4. Choose Cooling Vest System



- **DC70ML** - Med/Lg Cool Vest
- **DC70XLXXL** - XL/XXL Cool Vest
- **DC705X** - 5XL Cool Vest



- **DC5040, DC5040B, DC5040S** - Dual-Cool Industrial Interchange
- **DC5041** - Dual-Cool Schrader
- **DC5042** - Dual-Cool Snap-Tite Steel
- **DC5043** - Dual-Cool Snap-Tite Brass
- **DC5044** - Dual-Cool Snap-Tite Stainless Steel
- **DC5047** - Dual-Cool CEJN

5. Choose Belt and/or Accessories



- **4612** - Nylon Belt



- **36501** - Decon Belt

20LF Series Airline Respirator

20LF Series Constant Flow Respirator Systems for Use with Compressed Air

Narrow Facepieces

- CC20LF2L30** Tychem® QC Loose-Fitting Facepiece System
- 20LF2L large loose-fitting facepiece, narrow profile
 - X30 breathing tube assembly with F30 1/4" Industrial Interchange (Hansen compatible) nipple
 - 4612 nylon belt
 - Soft Plenum air delivery system
 - Latex-free construction with twist-lock breathing tube connection



-
- CC20LF2M30** Tychem® QC Loose-Fitting Facepiece System
- 20LF2M medium loose-fitting facepiece, narrow profile
 - X30 breathing tube assembly with F30 1/4" Industrial Interchange (Hansen compatible) nipple
 - 4612 nylon belt
 - Soft Plenum air delivery system
 - Latex-free construction with twist-lock breathing tube connection



-
- CC20LF2S30** Tychem® QC Loose-Fitting Facepiece System
- 20LF2S small loose-fitting facepiece, narrow profile
 - X30 breathing tube assembly with F30 1/4" Industrial Interchange (Hansen compatible) nipple
 - 4612 nylon belt
 - Soft Plenum air delivery system
 - Latex-free construction with twist-lock breathing tube connection



20LF Series Airline Respirator Replacement Hoods

Loose-Fitting Facepieces

20LF Series

- 10 per case
- Tychem QC
- Sewn in suspension
- Latex-free
- Quick-attach twist lock connection

20LFL

Loose-Fitting Facepiece, Large

20LFM

Loose-Fitting Facepiece, Medium

20LFL50

Same as 20LFL, 50 per case



20LFL

20LF2 Series

- 10 per case
- Tychem QC
- Narrow Profile
- Sewn in suspension
- Latex-free
- Quick-attach twist lock connection

20LF2L

Loose-Fitting Facepiece with Narrow Profile, Large

20LF2M

Loose-Fitting Facepiece with Narrow Profile, Medium

20LF2S

Loose-Fitting Facepiece with Narrow Profile, Small

20LF2L50

Same as 20LF2L, 50 per case

20LF2M50

Same as 20LF2M, 50 per case

20LF2S50

Same as 20LF2S, 50 per case



20LF2L



20LF Series Airline Respirator

20LF Series Breathing Tube Assemblies for Loose-Fitting Facepieces

Constant Flow Assemblies

Adjustable Flow Assemblies

- Assemblies include breathing tube (20LFBT) and nylon belt (4612)

- X30**
- With F30 1/4" Industrial Interchange (Hansen compatible) quick-disconnect nipple
 - For use with compressed air



- X40**
- With F40 1/4" Industrial Interchange (Hansen compatible) quick-disconnect nipple
 - For use with compressed air



- X31**
- With F31 1/4" Schrader quick-disconnect nipple
 - For use with compressed air



- X32**
- With F32 1/4" Snap-Tite steel quick-disconnect nipple
 - For use with compressed air



- X33**
- With F33 1/4" Snap-Tite brass quick-disconnect nipple
 - For use with compressed air



- X35**
- With F35 1/2" Industrial Interchange (Hansen compatible) quick-disconnect nipple
 - For use with Bullard Free-Air® pumps



20LF Series Airline Respirator

20LF Series Breathing Tube Replacement Parts

F30 Series Flow Controls

- 1/4" Industrial Interchange (Hansen compatible) quick-disconnect nipple
- Threaded hose connector
- For use with compressed air

F30	Constant Flow Control Fitting with Nylon Belt (4612)
F30VDB	Constant Flow Control Fitting with Vinyl Decon Belt (36501)
F30B	Constant Flow Control Fitting, Brass with Nylon Belt (4612)
F30S	Constant Flow Control Fitting, Stainless Steel with Nylon Belt (4612)
F30SD	Constant Flow Control Fitting, Stainless Steel with Decon Belt (36501)



F30

F31	Constant Flow Control Fitting <ul style="list-style-type: none"> • Same as F30 with 1/4" Schrader quick-disconnect nipple
------------	--



F32	Constant Flow Control Fitting <ul style="list-style-type: none"> • Same as F30 with 1/4" Snap-Tite steel quick-disconnect nipple
------------	---



F33	Constant Flow Control Fitting <ul style="list-style-type: none"> • Same as F30 with 1/4" Snap-Tite brass quick-disconnect nipple
------------	---



F34	Constant Flow Control Fitting <ul style="list-style-type: none"> • Same as F30 with 1/4" Snap-Tite stainless steel quick-disconnect nipple
------------	---



F35	Constant Flow Control Valve, Steel <ul style="list-style-type: none"> • Same as F30 with 1/2" Industrial Interchange (Hansen compatible) quick-disconnect nipple • For use with Bullard Free-Air® and ICE pumps
F35B	Constant Flow Control Fitting, Brass <ul style="list-style-type: none"> • Same as F30 with 1/2" Industrial Interchange (Hansen compatible) quick-disconnect nipple • For use with Bullard Free-Air® and ICE pumps



F35

F37	Constant Flow Control Fitting <ul style="list-style-type: none"> • Same as F30 with 1/4" CEJN quick-disconnect nipple
------------	--



20LF Series Airline Respirator

20LF Series Breathing Tube Replacement Parts

F40 Series Flow Controls

- 1/4" Industrial Interchange (Hansen compatible) quick-disconnect nipple
- Threaded hose connector
- For use with compressed air

- F40** Adjustable Flow Control Fitting, Steel, Nylon Belt (4612)
F40VDB Adjustable Flow Control Fitting, Vinyl Decon Belt (36501)
F40B Adjustable Flow Control Fitting, Brass, Nylon Belt (4612)
F40S Adjustable Flow Control Fitting, Stainless Steel, Nylon Belt (4612)
-



F40

- F41** Adjustable Flow Control Fitting
- Same as F40 with 1/4" Schrader quick-disconnect nipple



- F42** Adjustable Flow Control Fitting
- Same as F40 with 1/4" Snap-Tite steel quick-disconnect nipple



- F43** Adjustable Flow Control Fitting
- Same as F40 with 1/4" Snap-Tite brass quick-disconnect nipple



- F44** Adjustable Flow Control Fitting
- Same as F40 with 1/4" Snap-Tite stainless steel quick-disconnect nipple



- F47** Adjustable Flow Control Fitting
- Same as F40 with 1/4" CEJN quick-disconnect nipple



20LF Series Airline Respirator

20LF Series Breathing Tube Replacement Parts

20LFBT Breathing Tube for Loose-Fitting Facepieces
• Flow Control not included

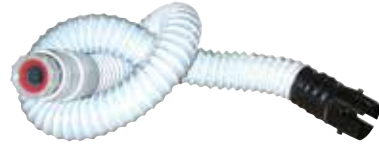

4612 Nylon Belt



36501 Vinyl Decon Belt



20QCBTC Tychem® QC Breathing Tube Cover
• Length 24.5"
• 1 each

20SLBTC Tychem® SL Breathing Tube Cover
• Length 24.5"
• 1 each



20QCBTC

POLYBTC Clear Poly Breathing Tube Cover Sleeve
• Length 38"
• 100 per package



RT Series Airline Respirator

Innovative and Proven

Similar to the proven design of the Bullard CC20, the top performing hood in the OSHA-acknowledged ORC Study, the RT Series hood family represents a significant improvement in the realm of Tychem® hood protection. In addition to the recognized benefits of hood-style respirators (no fit testing, no facial hair issues, and accommodates eyewear), the RT Series offers several unique, customer-driven features that make it stand out from other Tychem® hoods.

Patented Air Delivery System

Air flows into the neck cuff and is then directed through a three-channel air delivery system that delivers the air over the user's head, down the front of the lens and into the breathing zone. This unique air delivery method provides for a positive seal, minimizes fogging of the lens, minimizes dry eyes and nasal passages, and provides a reservoir of breathing air to help maintain positive pressure.

Panoramic View

The domed feature of the RT Series hood lens, provides added visibility and allows more light in minimizing the "closed-in," claustrophobic feeling sometimes experienced in other respirator hoods. A latex-free elastic band located in the neck cuff promotes curvature of the lens while aiding in the neck cuff's inflation.

Long Inner and Outer Bibs

The 20" long outer bibs of the RT Series provide splash protection and feature Velcro® straps that connect the front and rear outer bibs providing a custom fit, eliminating the possibility of the bib's "flipping up" during bending or scooping operations and providing added stability to the hood. Inner bibs add an additional barrier between the worker and the contaminants. With the bibs tucked in, the excess air flowing out of the respirator will travel across the user's body, creating a cooling effect.

Material Options

The RT Series Hood, made from DuPont™ Tychem®, is available in either Tychem® QC (RT1 and RT3) or Tychem® SL (RT2 and RT4). The RT2 and RT4, constructed of Tychem® SL, feature taped and sealed seams to minimize the potential for any inward leakage at the sewn seams. Tychem® SL is Saranex coated and provides excellent permeation characteristics against more caustic chemicals.

Ultimate Disposability

The RT Series Hood is available as a stand-alone replacement hood for those applications that allow for decontamination and reuse of the breathing tube. For those applications or processes that do not allow for decontamination, the RT Series is available fully assembled with a disposable lightweight breathing tube. After exiting from the area, the user may dispose of the complete assembly.

RT Series Hoods Perform in SWPF Study

At Bullard's request, the US Army's RDECOM (Research Development and Engineering Command) Center performed a Simulated Workplace Protection Factor (SWPF) study using the well-respected ORC Study protocol. Exercises were chosen to simulate activities that may be seen in a pharmaceutical manufacturing application. The RT Series Hood was shown to have 5th percentile SWPFs in excess of 100,000!



RT Series Airline Respirator

RT Series Airline Respirator Selection Chart

1. Choose Head Top



• **RT1** - Tychem® QC Double Bib Hood



• **RT2** - Tychem® SL (Saranex coated) Double Bib Hood with Taped Seams



• **RT3** - Tychem® QC Double Bib Hood



• **RT4** - Tychem® SL (Saranex coated) Double Bib Hood with Taped Seams

2. Choose Breathing Tube



• **20BT** - Breathing Tube for Hoods



• **RTBT** - Disposable Breathing Tube

3. Choose Flow Control Device



1/4" Continuous Flow
 • **F30, F30B, F30S** Industrial Interchange
 • **F31** - Schrader
 • **F32** - Snap-Tite Steel
 • **F33** - Snap-Tite Brass
 • **F34** - Snap-Tite Stainless
 • **F37** - CEJN

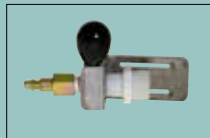

1/4" Adjustable Flow
 • **F40, F40B, F40S** Industrial Interchange
 • **F41** - Schrader
 • **F42** - Snap-Tite Steel
 • **F43** - Snap-Tite Brass
 • **F44** - Snap-Tite Stainless
 • **F47** - CEJN



1/2" Continuous Flow for Free-Air®Pumps
 • **F35, F35B**, Industrial Interchange



Cool Tubes for Compressed Air
 • **AC100030, AC100030B, AC100030S** Industrial Interchange
 • **AC100031** - Schrader
 • **AC100032** - Snap-Tite Steel



Hot/Cold Tubes
 • **HC240030, HC240030B, HC240030S** Industrial Interchange
 • **HC240031** - Schrader
 • **HC240032** - Snap-Tite Steel

4. Choose Belt and/or Accessories



• **4612** - Nylon Belt



• **36501** - Decon Belt



• **RTLC** - Lens Covers

5. Choose Cooling Vest System



• **DC70ML** - Med/Lg Cool Vest
 • **DC70LXXL** - XL/XXL Cool Vest
 • **DC705X** - 5XL Cool Vest



• **DC5040, DC5040B, DC5040S** Dual-Cool Industrial Interchange
 • **DC5041** - Dual-Cool Schrader
 • **DC5042** - Dual-Cool Snap-Tite Steel
 • **DC5043** - Dual-Cool Snap-Tite Brass
 • **DC5044** - Dual-Cool Snap-Tite Stainless Steel
 • **DC5047** - Dual-Cool CEJN

RT Series Airline Respirator

RT Systems

A complete RT Series Airline Respirator consists of the following three components:

1. Respirator Hood
2. Breathing Tube with Fitting or Optional Climate Control Assembly
3. Breathing Air Supply Hose

All three Bullard components must be present and properly assembled to constitute a NIOSH-approved respirator.

Approval No. TC-19C-412, Type C, Continuous Flow Class

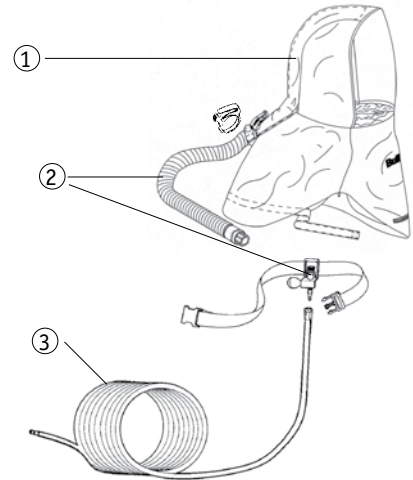

RT Series Constant Flow Respirator Systems for Compressed Air



RT330

Constant Flow Respirator Assembly

- RT3 Tychem® QC double bib hood system - extra-large lens
- Sport neck cuff
- No suspension required
- V30 breathing tube assembly with F30 1/4" Industrial Interchange (Hansen compatible) nipple and 4612 nylon belt
- For use with compressed air



RT430

Constant Flow Respirator Assembly

- RT4 Tychem® SL (Saranex coated) double bib hood system - extra-large lens
- Inflatable neck cuff
- Taped seams
- No suspension required
- V30 breathing tube assembly with F30 1/4" Industrial Interchange (Hansen compatible) nipple and 4612 nylon belt
- For use with compressed air



 Best Seller

RT Series Airline Respirator

RT Series Disposable Respirator Systems

RT1DA/RT3DA Series

- 5 per case
- Tychem® QC double bib hood - extra-large lens
- No suspension required
- RTBT lightweight disposable breathing tube assembly
- Preassembled and individually bagged
- Flow control device sold separately

RT1DA Constant Flow Disposable Assembly with Inflatable Neck Cuff
RT3DA Constant Flow Disposable Assembly with Sport Neck Cuff



RT3DA

RT1DA

RT2DA/RT4DA Series

- 5 per case
- Tychem® SL (Saranex coated) double bib hood - extra-large lens
- No suspension required
- RTBT lightweight disposable breathing tube assembly
- Preassembled and individually bagged
- Flow control device sold separately

RT2DA Constant Flow Disposable Assembly with Inflatable Neck Cuff
RT4DA Constant Flow Disposable Assembly with Sport Neck Cuff



RT4DA

RT2DA

RT Series Replacement Hoods

RT1/RT3 Series

- 5 per case
- Tychem® QC double bib hood - extra-large lens
- No suspension required
- Flow control and breathing tube sold separately

RT1 Tychem® QC double bib hood with Inflatable Neck Cuff
RT3 Tychem® QC double bib hood with Sport Neck Cuff



RT3

RT1

RT2/RT4 Series

- 5 per case
- Tychem® SL (Saranex coated) double bib hood - extra-large lens
- No suspension required
- Flow control and breathing tube sold separately

RT2 Tychem® SL double bib hood with Inflatable Neck Cuff
RT4 Tychem® SL double bib hood with Sport Neck Cuff



RT4

RT2

 Best Seller



RT Series Airline Respirator

RT Series Breathing Tube Assemblies

- Assemblies include breathing tube (20BT), nylon belt (4612), and clamp (S18051)

- V30**
- With F30 1/4" Industrial Interchange (Hansen compatible) quick-disconnect nipple
 - For use with compressed air



- V40**
- With F40 1/4" Industrial Interchange (Hansen compatible) quick-disconnect nipple
 - For use with compressed air



- V31**
- With F31 1/4" Schrader quick-disconnect nipple
 - For use with compressed air



- V41**
- With F41 1/4" Schrader quick-disconnect nipple
 - For use with compressed air



Air supply hose options

pp. 194-197

Heating and cooling options

pp. 201-206

RT Series Airline Respirator

RT Series Breathing Tube Assemblies

- Assemblies include breathing tube (20BT), nylon belt (4612), and clamp (S18051)

- V32**
- With F32 1/4" Snap-Tite steel quick-disconnect nipple
 - For use with compressed air



- V42**
- With F42 1/4" Snap-Tite steel quick-disconnect nipple
 - For use with compressed air



- V33**
- With F33 1/4" Snap-Tite brass quick-disconnect nipple
 - For use with compressed air



- V43**
- With F43 1/4" Snap-Tite brass quick-disconnect nipple
 - For use with compressed air



- V35**
- With F35 1/2" Industrial Interchange (Hansen compatible) quick-disconnect nipple
 - For use with Bullard Free-Air® or ICE pumps



RT Series Airline Respirator

RT Series Breathing Tube Replacement Parts

F30 Series Flow Controls

- 1/4" Industrial Interchange (Hansen compatible) quick-disconnect nipple
- Threaded hose connector
- For use with compressed air

- F30** Constant Flow Control Fitting with Nylon Belt (4612)
F30VDB Constant Flow Control Fitting with Vinyl Decon Belt (36501)
F30B Constant Flow Control Fitting, Brass with Nylon Belt (4612)
F30S Constant Flow Control Fitting, Stainless Steel with Nylon Belt (4612)
F30SD Constant Flow Control Fitting, Stainless Steel with Decon Belt (36501)



-
- F31** Constant Flow Control Fitting
- Same as F30 with 1/4" Schrader quick-disconnect nipple



-
- F32** Constant Flow Control Fitting
- Same as F30 with 1/4" Snap-Tite steel quick-disconnect nipple



-
- F33** Constant Flow Control Fitting
- Same as F30 with 1/4" Snap-Tite brass quick-disconnect nipple



-
- F34** Constant Flow Control Fitting
- Same as F30 with 1/4" Snap-Tite stainless steel quick-disconnect nipple



-
- F35** Constant Flow Control Fitting, Steel
- Same as F30 with 1/2" Industrial Interchange (Hansen compatible) quick-disconnect nipple
 - For use with Bullard Free-Air® and ICE pumps



-
- F35B** Constant Flow Control Fitting, Brass
- Same as F30 with 1/2" Industrial Interchange (Hansen compatible) quick-disconnect nipple
 - For use with Bullard Free-Air® and ICE pumps



RT Series Airline Respirator

RT Series Breathing Tube Replacement Parts

F40 Series Flow Controls

- 1/4" Industrial Interchange (Hansen compatible) quick-disconnect nipple
- Threaded hose connector
- For use with compressed air

- F40** Adjustable Flow Control Fitting, Steel, Nylon Belt (4612)
- F40VDB** Adjustable Flow Control Fitting, Vinyl Decon Belt (36501)
- F40B** Adjustable Flow Control Fitting, Brass, Nylon Belt (4612)
- F40S** Adjustable Flow Control Fitting, Stainless Steel, Nylon Belt (4612)

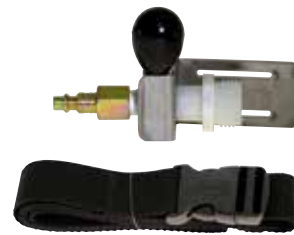

- F41** Adjustable Flow Control Fitting
 - Same as F40 with 1/4" Schrader quick-disconnect nipple



- F42** Adjustable Flow Control Fitting
 - Same as F40 with 1/4" Snap-Tite steel quick-disconnect nipple



- F43** Adjustable Flow Control Fitting
 - Same as F40 with 1/4" Snap-Tite brass quick-disconnect nipple



- F44** Adjustable Flow Control Fitting
 - Same as F40 with 1/4" Snap-Tite stainless steel quick-disconnect nipple



RT Series Airline Respirator

RT Series Breathing Tube Replacement Parts

20BT	Breathing Tube for Hoods <ul style="list-style-type: none">• Flow Control not included• S18051 clamp	
RTBT	Disposable Breathing Tube <ul style="list-style-type: none">• Flow Control not included• S18051 clamp	
S18051	Breathing Tube Clamp <ul style="list-style-type: none">• 10 per package	
S18051BLACK	Breathing Tube Clamp, Black <ul style="list-style-type: none">• 10 per package	
4612	Nylon Belt	
36501	Vinyl Decon Belt	
20QCBTC	Tychem® QC Breathing Tube Cover <ul style="list-style-type: none">• Length 24.5"• 1 each	 20QCBTC
20SLBTC	Tychem® SL Breathing Tube Cover <ul style="list-style-type: none">• Length 24.5"• 1 each	
POLYBTC	Clear Poly Breathing Tube Cover Sleeve <ul style="list-style-type: none">• Length 38"• 100 per package	
RTLC	Adhesive-Edged Mylar® Lens Covers <ul style="list-style-type: none">• 25 per package	

Blasting and Grinding Respirators



What are Blasting and Grinding Respirators?

Bullard has been a leader in the abrasive blasting and grinding industry since the 1930s, with the development of the supplied air abrasive blasting respirator for the construction of the Golden Gate Bridge. Since then, Bullard has continued to develop respiratory protection products for not only abrasive blasters, but many other applications including grinding, painting, welding, and chemical handling.

Abrasive Blasting

Abrasive blasting respirators are defined as Type CE by NIOSH according to 42CFR84 as follows:

84.130 Supplied-air respirators; description.

(f) "Type "CE" supplied-air respirators. A type "C" supplied-air respirator equipped with additional devices designed to protect the wearer's head and neck against impact and abrasion from rebounding abrasive material, and with shielding material such as plastic, glass, woven wire, sheet metal, or other suitable material to protect the window(s) of facepieces, hoods and helmets which do not unduly interfere with the wearer's vision and permit easy access to the external surface of such window(s) for cleaning."

Both the 88VX and the GenVX® are NIOSH approved as continuous flow Type C and Type CE abrasive blasting respirator, complete with a durable cape to protect the wearer's head and neck against abrasive rebound, as well as a durable helmet which meets the ANSI/ISEA Z98.1-2014, Type I, head protection standard requirements. The helmet has both an inner lens and an outer lens to meet the requirements of 42CFR.130 explained above. Both the GenVX® and the 88VX and GenVX® have independent 3rd party data to support 1000 APF.

Grinding

Bullard was one of the first to offer a hood-style respirator designed specifically with grinding operations in mind. The GR50 is lightweight and fully protective with a Nomex® outer hood, flame retardant inner bib, and the ability to integrate a hard hat.

Solutions

Whether blasting or grinding, Bullard can provide the appropriate respiratory protection.



GenVX[®] Series Airline Respirator

The next generation of blasting.

The GenVX is the newest blasting helmet from Bullard, providing users with the industry's lightest, coolest, most comfortable, and most dependable helmet on the market for abrasive blasters and painters.

The GenVX Series airline respirators are approved by NIOSH (TC-19C-0489, TC-19C-0491, TC-19C-0492, TC-19C-0493, TC-19C-0494, TC-19C-0495, TC-19C-0496, Type C and CE) to provide respiratory protection in general purpose applications including heavy- and light-duty abrasive blasting, and Type C and CE painting applications.

Superior Protection and Comfort

The GenVX offers superior protection to workers who are exposed to the harsh environments of blasting and painting. It is a full pound lighter than competitive products and offers the most cooling options for added comfort. Constructed from High-Density Polyethylene (HDPE) for superior strength, the sleek design of the GenVX allows air to pass directly over the user's head, providing greater air flow and improved cooling.

The helmet offers launderable, removable, and adjustable cheek pads for increased comfort and stability and a "Grit Guard" visor that keeps debris out of the lens. The GenVX is equipped with a six-point suspension, wide 1" straps for maximum comfort and a ratchet knob for easy adjustments. The center breathing tube connection provides greater balance to the user.

Dependable

Third-party 1,000 Assigned Protection Factor (APF) data and ANSI/ISEA Z89 Head Protection and High-Impact Z87+ Face Protection ratings make the GenVX the most dependable blast helmet available on the market.



GenVX[®]

GenVX[®] Series Airline Respirator

Technical Specifications			
Regulatory		Lens System	
Assigned Protection Factor (APF)	1,000 (third party tested)	Viewing area	4" x 9.75"
ANSI/ISEA Z89.1-2014, Type I, Class C		Inner lens	.040" Tritan™*
ANSI/ISEA Z87.1-2015, Z87+ High-Impact Face Protection		Outer lens	.015" PETG
Optional adhesive-backed Mylar® lens covers or tinted lenses		Capes	
Helmet		8 oz. Nylon Denier	
Material	High-density Polyethylene shell & door	Continuous steel cable attachment	
Weight	2.39 lbs.	28" standard	
Suspension		Third hand for easy installation	
6-pt. Flex-Gear® Ratchet			
Adjustable to fit sizes 6.5-8			
1" wide nylon webbing			

* Impact- and chemical-resistant faceshield

† Other thicknesses and tints available

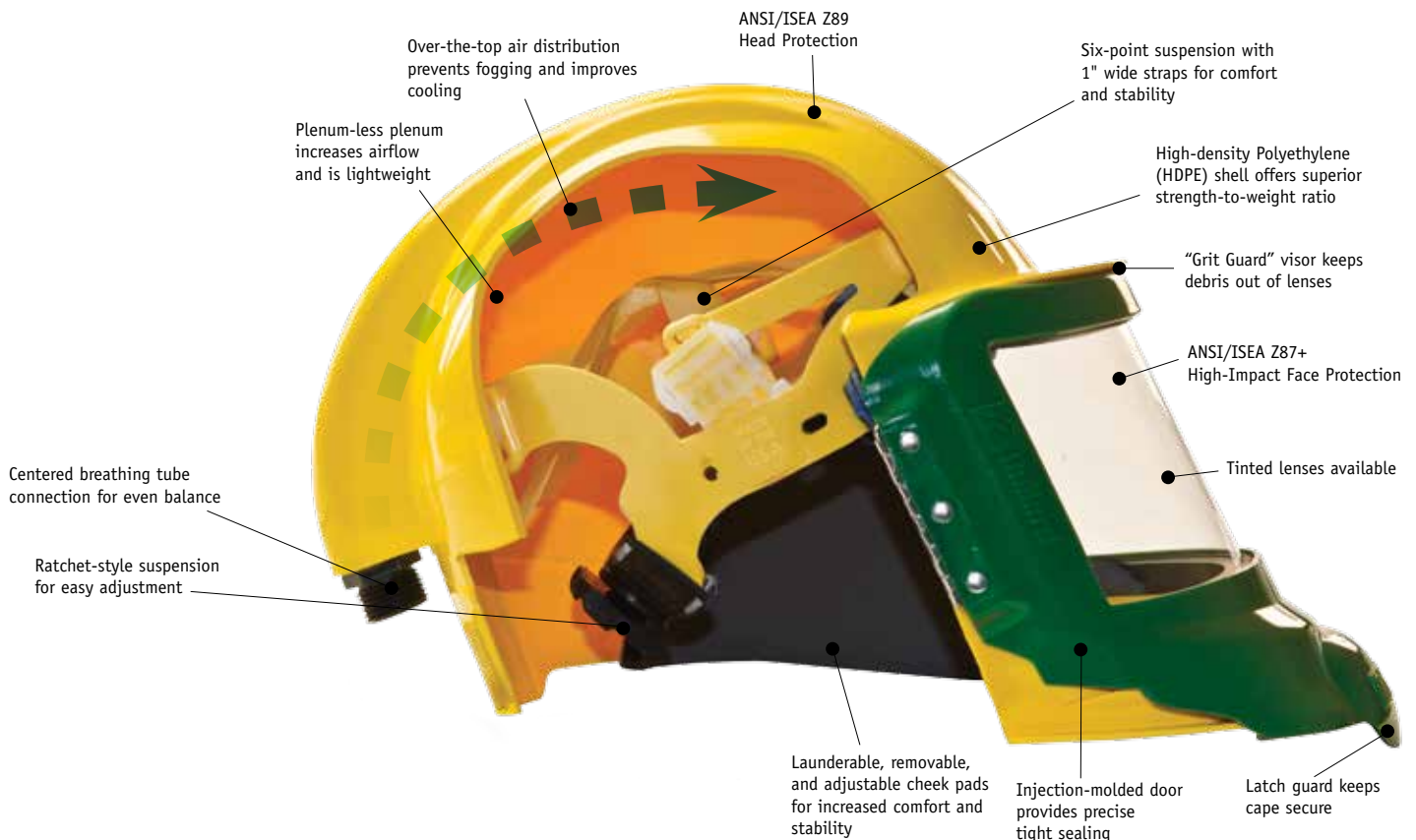

GenVX® Series Airline Respirator

GenVX® Series Airline Respirator Selection Chart

1. GenVX® Hood



- **Oval Window** (Standard)

2. Choose Suspension

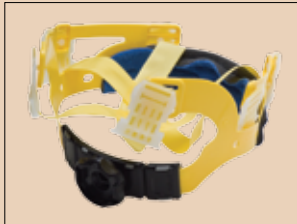

- **GVXRT & GVXPL** - Adjustable Flex-Gear® Ratchet Headband Suspension

3. GenVX® Breathing Tube



- **GVXBT** - Flow control not included

4. Choose Flow control



- **F30, F30B, F30S** Constant Flow control Valve, 1/4" Industrial Interchange
- **F31** - Schrader
- **F32** - Snap-Tite Steel
- **F33** - Snap-Tite Brass
- **F34** - Snap-Tite Stainless
- **F37** - CEJN
- **F38** - Bayonet Steel



- **F35, F35B**, for Free-Air® Pumps Constant Flow control Valve, 1/2" Industrial Interchange

4. Choose Flow control continued...

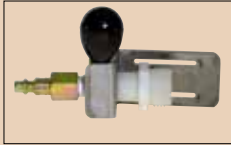

1/4" Adjustable Flow

- **F40, F40B, F40S** - Industrial Interchange (Hansen Compatible)
- **F41** - Schrader
- **F42** - Snap-Tite Steel
- **F43** - Snap-Tite Brass
- **F44** - Snap-Tite Stainless
- **F47** - CEJN
- **F48** - Bayonet Steel



Cool Tubes for Compressed Air (Metal)

- **AC100030, AC100030B, AC100030S** - 1/4" Industrial Interchange (Hansen Compatible)
- **AC100031** - Schrader
- **AC100032** - Snap-Tite Steel
- **AC100033** - Snap-Tite Brass
- **AC100034** - Snap-Tite Stainless
- **AC100037** - CEJN
- **AC100038** - Bayonet Steel



Cool Tubes for Free-Air® Pumps

- (ADP20, EDP30 and ICE Pumps)
- **FRIGITRON2000** 1/2" Industrial Interchange (Hansen Compatible)
- **FRIGITRON2000B** Brass



Cool Tubes for Compressed Air (Plastic)

- **CT30, CT30B, CT30S** 1/4" Industrial Interchange
- **CT30SW, CT30BSW, CT30SSW** 1/4" Industrial Interchange (Hansen Compatible) with Dynaswivel fitting
- **CT31** - Schrader
- **CT32** - Snap-Tite Steel
- **CT33** - Snap-Tite Brass
- **CT34** - Snap-Tite Stainless
- **CT37** - CEJN
- **CT38** - Bayonet Steel



Hot/Cold Tubes for Compressed Air (Plastic)

- **HCT30, HCT30B, HCT30S** 1/4" Industrial Interchange
- **HCT30SW, HCT30BSW, HCT30SSW** 1/4" Industrial Interchange with Dynaswivel fitting (Hansen Compatible)
- **HCT31** - Schrader
- **HCT32** - Snap-Tite Steel
- **HCT33** - Snap-Tite Brass
- **HCT34** - Snap-Tite Stainless
- **HCT37** - CEJN
- **HCT38** - Bayonet Steel



Hot/Cold Tubes for Compressed Air (Metal)

- **HC240030, HC240030B, HC240030S** 1/4" Industrial Interchange (Hansen Compatible)
- **HC240031** - Schrader
- **HC240032** - Snap-Tite Steel
- **HC240033** - Snap-Tite Brass
- **HC240034** - Snap-Tite Stainless
- **HC240037** - CEJN
- **HC240038** - Bayonet Steel

5. Choose Cape



- **28VX** - 28" Nylon Cape
- **38VX** - 38" Nylon Cape



- **GGVX** - 38" "Golden Gate" Nylon Cape



- **PKVX** - 38" Nylon Parka
- **PKVXLVX** - 38" Extra Large Nylon Parka

6. Choose Cooling Vest



- **DC70ML** - Med/Lg Cool Vest
- **DC70LXXL** - XL/XXL Cool Vest
- **DC705X** - 5XL Cool Vest



- **DC5040** - Dual-Cool Industrial Interchange
- **DC5041** - Dual-Cool Schrader
- **DC5042** - Dual-Cool Snap-Tite Steel
- **DC5044** - Dual-Cool Snap-Tite Stainless
- **DC5047** - Dual-Cool CEJN

7. Choose Belt and/or Accessories



- **4612** - Nylon Belt

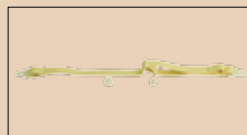

- **GVXCS** - Chinstrap



- **GVXLC** - Adhesive Mylar® Lens Cover



- **GVXCP** - Cheek Pads, Pair

GenVX® Series Airline Respirator

A complete GenVX® Series Airline Respirator consists of the following three components:

1. Respirator Helmet and Cape
2. Breathing Tube with Fitting or Optional Climate Control Assembly
3. Breathing Air Supply Hose

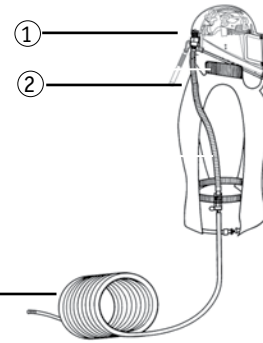



All three Bullard components must be present and properly assembled to constitute a NIOSH-approved respirator.

Approval No. TC-19C-0489, TC-19C-0491, TC-19C-0492, TC-19C-0493, TC-19C-0494, TC-19C-0495, TC-19C-0496, Type C and CE, Continuous Flow Class

GenVX® Series Respirator Assemblies for use with Compressed Air

Respirators with 28VX Nylon Cape – 28" Length

-  **GVX2830** F30 Constant Flow 1/4" Industrial Interchange Fitting
-  **GVX2830CT** CT30 Cool Tube 1/4" Industrial Interchange Fitting
- GVX2830AC1000** AC1000 Cool Tube 1/4" Industrial Interchange Fitting
- GVX2830HCT** HCT30 Hot/Cold Tube 1/4" Industrial Interchange Fitting
- GVX2830HC2400** HC2400 Hot/Cold Tube 1/4" Industrial Interchange Fitting
- GVX2840** F40 Adjustable Flow 1/4" Industrial Interchange Fitting
- GVX2831CT** CT31 Cool Tube 1/4" Schrader Fitting
- GVX2831AC1000** AC100031 Cool Tube 1/4" Schrader Fitting

All systems above include:

- Breathing tube assembly (GVXBT)
- Inner and outer lens with Mylar® lens cover
- Chinstrap (GVXCS)



GVX2830

Best Seller

Respirators with 38VX Nylon Cape – 38" Length

- GVX3830** F30 Constant Flow 1/4" Industrial Interchange Fitting
- GVX3830CT** CT30 Cool Tube 1/4" Industrial Interchange Fitting
- GVX3830AC1000** AC1000 Cool Tube 1/4" Industrial Interchange Fitting
- GVX3830HCT** HCT30 Hot/Cold Tube 1/4" Industrial Interchange Fitting
- GVX3830HC2400** HC2400 Hot/Cold Tube 1/4" Industrial Interchange Fitting
- GVX3840** F40 Adjustable Flow 1/4" Industrial Interchange Fitting

All systems above include:

- Breathing tube assembly (GVXBT)
- Inner and outer lens with Mylar® lens cover
- Chinstrap (GVXCS)



GVX3830CT

Respirators with PKVX Hibernia Parka (Tan) – 38" Length

- GVXPK30** F30 Constant Flow 1/4" Industrial Interchange Fitting
- GVXPK30CT** CT30 Cool Tube 1/4" Industrial Interchange Fitting
- GVXPK30XLCT** GVX3830CT with Extra-Large Parka
- GVXPK30AC1000** AC1000 Cool Tube 1/4" Industrial Interchange Fitting
- GVXPK30HCT** HCT30 Hot/Cold Tube 1/4" Industrial Interchange Fitting
- GVXPK30HC2400** HC2400 Hot/Cold Tube 1/4" Industrial Interchange Fitting
- GVXPK40** F40 Adjustable Flow 1/4" Industrial Interchange Fitting

All systems above include:

- Breathing tube assembly (GVXBT)
- Inner and outer lens with Mylar® lens cover
- Chinstrap (GVXCS)



GVXPK30



Blasting and Grinding

GenVX® Series Airline Respirator

GenVX® Series Respirator Assembly for use with Bullard Free-Air® Pumps

Complete Respirator Work Systems

GVXSYS GVX2835 Respirator with 28VX Nylon Cape – 28" length
ADP20 Free-Air® Pump
V2050ST Air Supply Hose
FRIGITRON2000 climate control device



GVXSTS16TE GVX2835 Respirator with 28VX Nylon Cape – 28" length
EDP16TE Free-Air® Pump
V2050ST Air Supply Hose



GVXICESYS GVX2835 Respirator with 28VX Nylon Cape – 28" length
ICEPUMP11 Pump
V20100ST Air Supply Hose
FRIGITRON2000 climate control device

All systems above include:

- Breathing tube assembly with F35 Constant Flow
1/2" Industrial interchange quick-disconnect fitting
- Inner and outer lens with Mylar® lens cover (package of five)
- Chinstrap (GVXCS)



GenVX® Series Airline Respirator

GenVX® Series Respirator Assembly for use with Bullard Free-Air® Pumps

Respirator Assemblies

GVX2835 Respirator with 28VX Nylon Cape – 28" length

- Breathing tube assembly with F35 Constant Flow
1/2" Industrial interchange quick-disconnect fitting
- Inner and outer lens with Mylar® lens cover (package of five)
- Chinstrap (GVXCS)



GVX3835 Respirator with 38VX Nylon Cape – 38" length

- Breathing tube assembly with F35 Constant Flow
1/2" Industrial interchange quick-disconnect fitting
- Inner and outer lens with Mylar® lens cover (package of five)
- Chinstrap (GVXCS)



GVXPK35 Respirator with PKVX Nylon long sleeve parka – 38" length

- Breathing tube assembly with F35 Constant Flow
1/2" Industrial interchange quick-disconnect fitting
- Inner and outer lens with Mylar® lens cover (package of five)
- Chinstrap (GVXCS)



GenVX® Series Airline Respirator

GenVX® Series Replacement Valves for Breathing Tube Assemblies for use with Compressed Air

F30

Constant Flow control

- 3/4" Industrial Interchange (Hansen Compatible) quick-disconnect flow control
- Threaded hose connector
- Nylon belt (4612)



F31

Constant Flow control

- 3/4" Schrader quick-disconnect flow control
- Threaded hose connector
- Nylon belt (4612)



F32

Constant Flow control

- 3/4" Snap-Tite steel quick-disconnect flow control
- Threaded hose connector
- Nylon belt (4612)



F33

Constant Flow control

- 3/4" Snap-Tite brass quick-disconnect flow control
- Threaded hose connector
- Nylon belt (4612)



F37

Constant Flow control

- 3/4" CEJN steel quick-disconnect flow control
- Threaded hose connector
- Nylon belt (4612)



F38

Constant Flow control Valve

- 3/4" Bayonet steel quick-disconnect flow control
- Threaded hose connector
- Nylon belt (4612)
- No ball bearings to clog with grit



GenVX® Series Airline Respirator

GenVX® Series Replacement Valves for Breathing Tube Assemblies for use with Compressed Air

F40

Adjustable Flow control

- 1/4" Industrial Interchange (Hansen Compatible) quick-disconnect flow control
- Threaded hose connector
- Nylon belt (4612)

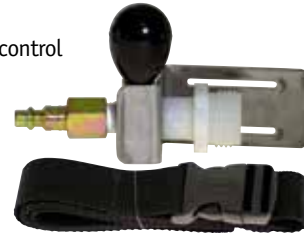

F41

Adjustable Flow control

- 1/4" Schrader quick-disconnect flow control
- Threaded hose connector
- Nylon belt (4612)



F42

Adjustable Flow control

- 1/4" Snap-Tite steel quick-disconnect flow control
- Threaded hose connector
- Nylon belt (4612)



F47

Adjustable Flow control Valve

- 1/4" CEJN stainless steel quick-disconnect flow control
- Threaded hose connector
- Nylon belt (4612)



GenVX® Series Replacement Valves for Breathing Tube Assemblies for use with Bullard Free-Air® Pumps

F35

Constant Flow control

- 1/2" Industrial Interchange (Hansen Compatible) quick-disconnect flow control
- Threaded hose connector
- Nylon belt (4612)



GenVX® Series Airline Respirator

GenVX® Series Replacement Capes



28VX

28" Length Nylon Cape (Tan)

- Includes snap hooks
- Includes breathing tube straps
- Includes additional nylon liner in neck cuff area
- Includes 3rd hand tab assist



Best Seller

38VX

38" Length Nylon Cape (Tan)

- Includes snap hooks
- Includes breathing tube straps
- Includes additional nylon liner in neck cuff area
- Includes 3rd hand tab assist



GGVX

38" Length "Golden Gate" Nylon Cape (Tan)

- Includes Cinch Straps/Fabric Ties
- Includes breathing tube straps
- Includes additional nylon liner in neck cuff area
- Includes 3rd hand tab assist



PKVX

38" Length Hibernia Parka (Tan)

PKXLVX

38" Length Hibernia Parka Extra-Large Size (Tan)

- Includes breathing tube straps
- Includes additional nylon liner in neck cuff area
- Includes 3rd hand tab assist



PKVX

GenVX® Series Airline Respirator

GenVX® Series Replacement Parts

4612 Nylon Belt



GVXBT Breathing Tube
• Flow control device not included



GVXCT Breathing Tube Connector Kit
• Coupling Connector
• Foam airline plug



GVXBTW Breathing Tube Washer
• (10 pack)



RBPCOTTON Replacement Brow Pad, Cotton
• Absorbent cotton replacement brow pad
• Fits all Bullard suspensions
• Easy, Velcro® design



RBPVINYL Replacement Brow Pad, Vinyl
• Vinyl replacement brow pad
• Fits all Bullard suspensions
• Easy, Velcro® design



RBPCOOL Replacement Brow Pad, Cooling
• Polartec replacement brow pad
• Wicking material moves sweat away from the worker's brow
• Fits all Bullard suspensions
• Easy, Velcro® design



GenVX® Series Replacement Parts and Accessories

GVXRT Adjustable Ratchet Six-Point Flex-Gear® Headband Suspension
• Cotton Brow Pad



GVXPL Adjustable Pinlock Six-Point Headband Suspension
• Cotton Brow Pad



GVXCS Elastic Chinstrap
• For use with GenVX® Series only
• 10 per package



GVXCA Replacement Carrying Strap



GVXDMK Maintenance Kit – Door/Gasket
• Includes GenVX® Series door with gasket, inner lens and hinge pin in a kit ready for mounting



GVXIG Inner Gasket



GVXHP Replacement Hinge Pins for GenVX® Door Frame
• 10 per package

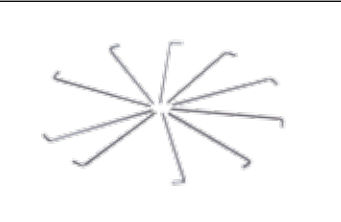

GVXCP Replacement Cheek Pads
• One pair per package
• Velcro® attachment straps included



GenVX® Series Replacement Parts and Accessories

GenVX® Series Mylar® Lens

- GVXLC** Adhesive-backed Mylar® Lens Cover
- Clear
 - 25 per package



GenVX® Series Replacement Lenses

Inner Lens

Tritan, For Use with GenVX® Series

- GVXIL**
- 25 per package
 - .040" thick

- BGVXIL**
- Eight packages of 25
 - .040" thick



Outer Lenses

PETG, For Use with GenVX® Series

- GVXOL40**
- 25 per package
 - .040" thick

- BGVXOL40**
- Eight packages of 25
 - .040" thick

- GVXOL15**
- 50 per package
 - .015" thick

- BGVXOL15**
- Ten packages of 50
 - .015" thick



Tritan, For Use with GenVX® Series

- GVXOLT**
- 25 per package
 - Tinted Lens, Smoke
 - .030" thick

Acetate, For Use with GenVX® Series

- GVXOLG**
- 25 per package
 - Tinted Lens, Green
 - .042" thick



Smoke



Green



88VX Series Airline Respirator

The most popular blasting respirator in the industry.

The Bullard 88VX Series airline respirators offer comfort and reliable respiratory protection for abrasive blasters and painters.

The 88VX Respirator is NIOSH approved as a Type C and CE Continuous Flow Class Respirator (Approval No. TC-19C-293).

Advanced Protection

88VX Series airline respirators provide advanced protection in the harsh exposures of blasting and painting. The snug, yet comfortable, sewn-in neck cuff provides a physical barrier to airborne contaminants and helps maintain positive pressure within the helmet. A double lining in the neck area enhances durability and protection.

Comfortable Fit

A lightweight inner shell with an adjustable headband suspension holds the respirator firmly and comfortably on the wearer's head. Airflow is channeled directly to the user's breathing zone for easy breathing. The helmet easily accommodates beards, prescription eye wear, or safety glasses. No fit testing is required.

Head Protection

The helmet provides top impact and penetration protection. The helmet and cape help protect the worker's entire head, face, and upper body from abrasive rebound, airborne contaminants, and messy overspray.

Optimum Visibility

The wide-angle faceshield lens and headband suspension system are positioned for optimum visibility. With the translucent yellow helmet, workers don't experience a closed-in feeling. Tinted lenses also help reduce glare.

Overall Convenience

88VX respirator components are easily replaceable, saving you lost time on the job as well as eliminating the inconvenience of having to replace the entire respirator assembly.

Climate Control

Optional climate control assemblies permit workers to warm or cool incoming air to maximize comfort and improve productivity. Approved climate control models include CT, HCT, AC1000, HC2400, Frigatron, and Dual-Cool.



88VX Series Airline Respirator

Features and Benefits

Injection-molded inner shell

Key slots for suspension are molded in the shell to provide a proper fit. The shell is also lightweight, compact, and portable.

Latch design on window frame and helmet

Strong, low profile provides tension on window and protection for the interior cape hook.

Forest green window frame gasket material

Durable, resistant to temperature variations, conforms to window frame. Easy to install into hood and replace inner lens.

Forest green window frame material

Flexible and durable with a gasket seal. Easy to install outer lens.

Breathing tube with flexible coating and forest green cuffs

Flexible and durable, reducing the amount of strain on the helmet and thus the user's neck.

Cape design with double lining above neck

Double lining enhances durability, comfort, and protection.

Latch position behind window frame

Reduces difficulty of attaching cape to helmet and prevents accidental opening.

Breathing tube positioning loops on back of cape to retain the breathing tube

Reduced snagging hazard on breathing tube.

Mylar® cover lens with new pull-tab design

Easier to pull off used cover lens.

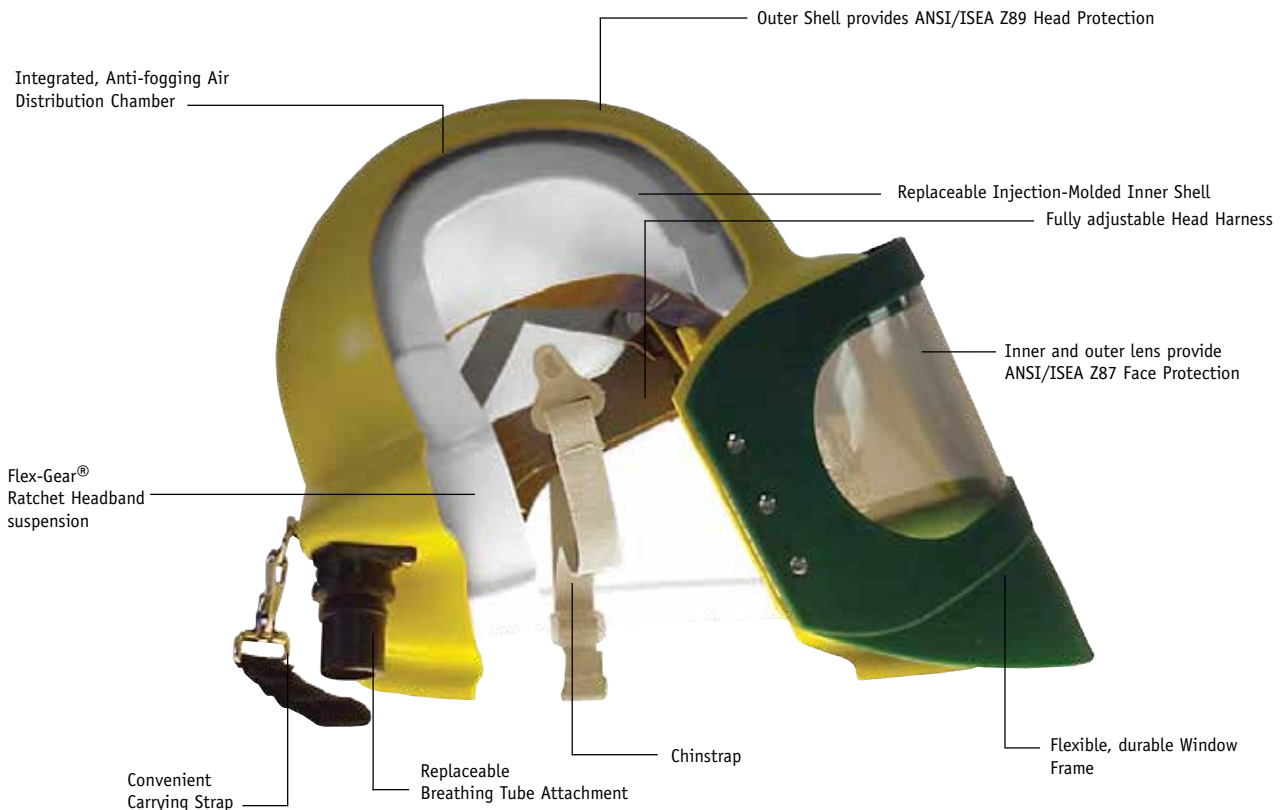

88VX Series Airline Respirator

88VX Series Airline Respirator Selection Chart

1. Choose Window Style (Helmet included)



• **Oval Window**
(Standard)



• **Box Front**
(Optional)

2. Choose Suspension



• **88VXRTP** - Adjustable Flex-Gear® Ratchet Headband Suspension - Inner Shell/Air Plenum included

3. Choose Breathing Tube



• **88VXBT** - Flow control not included

4. Choose Flow control



• **F30, F30B, F30S** - Constant Flow control Valve, 1/4" Industrial Interchange (Hansen Compatible)

- **F31** - Schrader
- **F32** - Snap-Tite Steel
- **F33** - Snap-Tite Brass
- **F34** - Snap-Tite Stainless
- **F37** - CEJN
- **F38** - Bayonet Steel



• **F35, F35B**, for Free-Air® Pumps - Constant Flow control Valve, 1/2" Industrial Interchange (Hansen Compatible)

4. Choose Flow control continued...

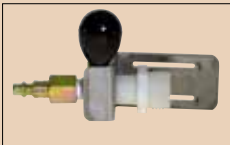

1/4" Adjustable Flow

- **F40, F40B, F40S** Industrial Interchange (Hansen Compatible)
- **F41** - Schrader
- **F42** - Snap-Tite Steel
- **F43** - Snap-Tite Brass
- **F44** - Snap-Tite Stainless
- **F47** - CEJN
- **F48** - Bayonet Steel



Cool Tubes for Compressed Air (Metal)

- **AC100030, AC100030B, AC100030S** 1/4" Industrial Interchange (Hansen Compatible)
- **AC100031** - Schrader
- **AC100032** - Snap-Tite Steel
- **AC100033** - Snap-Tite Brass
- **AC100034** - Snap-Tite Stainless
- **AC100037** - CEJN
- **AC100038** - Bayonet Steel



Cool Tubes for Free-Air® Pumps (ADP20, EDP30 and ICE)

- **FRIGITRON2000** - 1/2" Industrial Interchange (Hansen Compatible)
- **FRIGITRON2000B** Brass



Cool Tubes for Compressed Air (Plastic)

- **CT30, CT30B, CT30S** 1/4" Industrial Interchange
- **CT30SW, CT30BSW, CT30SSW** 1/4" Industrial Interchange with Dynaswivel fitting (Hansen Compatible)
- **CT31** - Schrader
- **CT32** - Snap-Tite Steel
- **CT33** - Snap-Tite Brass
- **CT34** - Snap-Tite Stainless
- **CT37** - CEJN
- **CT38** - Bayonet Steel



Hot/Cold Tubes for Compressed Air (Plastic)

- **HCT30, HCT30B, HCT30S** 1/4" Industrial Interchange
- **HCT30SW, HCT30BSW, HCT30SSW** 1/4" Industrial Interchange with Dynaswivel fitting (Hansen Compatible)
- **HCT31** - Schrader
- **HCT32** - Snap-Tite Steel
- **HCT33** - Snap-Tite Brass
- **HCT34** - Snap-Tite Stainless
- **HCT37** - CEJN
- **HCT38** - Bayonet Steel



Hot/Cold Tubes for Compressed Air (Metal)

- **HC240030, HC240030B, HC240030S** 1/4" Industrial Interchange (Hansen Compatible)
- **HC240031** - Schrader
- **HC240032** - Snap-Tite Steel
- **HC240033** - Snap-Tite Brass
- **HC240034** - Snap-Tite Stainless
- **HC240037** - CEJN
- **HC240038** - Bayonet Steel

5. Choose Cape



• **46VX** - 28" Nylon Cape
• **13VX** - 38" Nylon Cape



• **21821** - 38" "Golden Gate" Nylon Cape



• **36VX** - 38" Nylon Parka
• **36XLVX** - 38" XL Nylon Parka

6. Choose Cooling Vest



• **DC70ML** - Med/Lg Cool Vest
• **DC70XLXXL** - XL/XXL Cool Vest
• **DC705X** - 5XL Cool Vest



• **DC5040** - Dual-Cool Industrial Interchange (Hansen Compatible)
• **DC5041** - Dual-Cool Schrader
• **DC5042** - Dual-Cool Snap-Tite Steel
• **DC5044** - Dual-Cool Snap-Tite Stainless
• **DC5047** - Dual-Cool CEJN

7. Choose Belt and/or Accessories



• **4612** - Nylon Belt



• **20NC** - Chinstrap



• **7714** - Adhesive Backed Lens Cover



• **88VXLC** - Perforated Lens Covers

88VX Series Airline Respirator

A complete 88VX Series Airline Respirator consists of the following three components:

1. Respirator Helmet and Cape
2. Breathing Tube with Fitting or Optional Climate Control Assembly
3. Breathing Air Supply Hose

All three Bullard components must be present and properly assembled to constitute a NIOSH approved respirator.

Approval No. TC-19C-293, Type C and CE, Continuous Flow Class

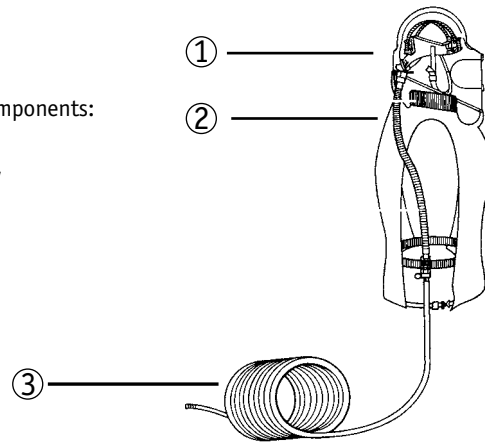

88VX Series Respirator Assemblies for use with Compressed Air

Respirators with 46VX Nylon Cape - 28" Length

- 88VX3230** F30 Constant Flow $\frac{1}{4}$ " Industrial Interchange Fitting
 - 88VX3240** F40 Adjustable Flow $\frac{1}{4}$ " Industrial Interchange Fitting
 - 88VX3230H** F30 Constant Flow $\frac{1}{4}$ " Industrial Interchange Fitting with 4696 Starter Hose 25'
 - 88VX3231** F31 Constant Flow $\frac{1}{4}$ " Schrader Fitting
- All systems above include:
- Breathing tube assembly (88VXBT)
 - Inner and outer lens with Mylar® lens cover (package of five)
 - Chinstrap (20NC)



88VX3230

Best Seller

Respirators with 13VX Nylon Cape - 38" Length

- 88VX1330** F30 Constant Flow $\frac{1}{4}$ " Industrial Interchange Fitting
- System above includes:
- Breathing tube assembly (88VXBT)
 - Inner and outer lens with Mylar® lens cover (package of five)
 - Chinstrap (20NC)



88VX Series Airline Respirator

88VX Series Respirator Assemblies for Use with Compressed Air

Respirators with 36VX Hibernia Parka (Tan) - 38" length
88VX3630 F30 Constant Flow 1/4" Industrial Interchange Fitting
88VX36XL30 88VX3630 with Extra-Large Parka

All systems above include:

- Breathing tube assembly (88VXBT)
- Inner and outer lens with Mylar® lens cover (package of five)
- Chinstrap (20NC)



88VX Series Respirator Assemblies for use with Bullard Free-Air® Pumps

Complete Respirator Work System

88VXSYS 88VX3235 Respirator with 28VX Nylon Cape - 28" length
ADP20 Free-Air® Pump
V2050ST Air Supply Hose
FRIGITRON2000 climate control device

88VXSYS16TE 88VX3235 Respirator with 46VX Nylon Cape - 28" length
EDP16TE Free-Air® Pump
V2050ST Air Supply Hose

All systems above include:

- Breathing tube assembly (88VXBT)
- Inner and outer lens with Mylar® lens cover (package of five)
- Chinstrap (20NC)



88VXSYS

88VXICESYS 88VX3235 Respirator with 46VX Nylon Cape - 28" length
ICEPump11 Pump
V2050ST Air Supply Hose

All systems above include:

- Breathing tube assembly (88VXBT)
- Inner and outer lens with Mylar® lens cover (package of five)
- Chinstrap (20NC)



Respirators with 46VX Nylon Cape - 28" length

88VX3235 F35 Constant Flow 1/2" Industrial Interchange Fitting
88VX3235H100 F35 Constant Flow 1/2" Industrial Interchange Fitting with
V20100ST Supply Hose, 100'

All systems above include:

- Breathing tube assembly (88VXBT)
- Inner and outer lens with Mylar® lens cover (package of five)
- Chinstrap (20NC)

Respirators with 13VX Nylon Cape - 38" length

88VX1335 F35 Constant Flow 1/2" Industrial Interchange Fitting

System above includes:

- Breathing tube assembly (88VXBT)
- Inner and outer lens with Mylar® lens cover (package of five)
- Chinstrap (20NC)



88VX3235

88VX Series Airline Respirator

88VX Breathing Tube Assemblies

Constant Flow Breathing Tube Assemblies - for use with compressed air

- EVX30** F30 1/4" Industrial Interchange (Hansen Compatible) quick-disconnect flow control
- EVX31** F31 1/4" Schrader quick-disconnect Flow control
- EVX32** F32 1/4" Snap-Tite Steel quick-disconnect Flow control
- EVX33** F33 1/4" Snap-Tite Brass quick-disconnect Flow control
- EVX37** F37 1/4" CEJN quick-disconnect Flow control
- EVX38** F38 1/4" Bayonet quick-disconnect Flow control

All above include:

- Breathing tube (88VXBT)
- Nylon belt (4612)



EVX30

Adjustable Flow Breathing Tube Assemblies - for use with compressed air

- EVX40** F40 1/4" Industrial Interchange (Hansen Compatible) quick-disconnect flow control
- EVX41** F41 1/4" Schrader quick-disconnect Flow control
- EVX42** F42 1/4" Snap-Tite Steel quick-disconnect Flow control
- EVX43** F43 1/4" Snap-Tite Brass quick-disconnect Flow control
- EVX47** F47 1/4" CEJN quick-disconnect Flow control
- EVX48** F48 1/4" Bayonet quick-disconnect Flow control

All above include:

- Breathing tube (88VXBT)
- Nylon belt (4612)



EVX40

Constant Flow Breathing Tube Assembly - for use with Bullard Free-Air® Pump

- EVX35** F35 1/2" Industrial Interchange (Hansen Compatible) quick-disconnect flow control

Above includes:

- Breathing tube (88VXBT)
- Nylon belt (4612)



88VX Series Airline Respirator

88VX Series Replacement Valves for Breathing Tube Assemblies for use with Compressed Air

F30

Constant Flow control

- 1/4" Industrial Interchange (Hansen compatible) quick-disconnect flow control
- Threaded hose connector
- Nylon belt (4612)



F31

Constant Flow control

- 1/4" Schrader quick-disconnect flow control
- Threaded hose connector
- Nylon belt (4612)



F32

Constant Flow control

- 1/4" Snap-Tite steel quick-disconnect flow control
- Threaded hose connector
- Nylon belt (4612)



F33

Constant Flow control

- 1/4" Snap-Tite brass quick-disconnect flow control
- Threaded hose connector
- Nylon belt (4612)



F37

Constant Flow control

- 1/4" CEJN steel quick-disconnect flow control
- Threaded hose connector
- Nylon belt (4612)



F38

Constant Flow control Valve

- 1/4" Bayonet steel quick-disconnect flow control
- Threaded hose connector
- Nylon belt (4612)
- No ball bearings to "clog" with grit



88VX Series Airline Respirator

88VX Series Replacement Valves for Breathing Tube Assemblies for use with Compressed Air

F40

Adjustable Flow control

- 1/4" Industrial Interchange (Hansen Compatible) quick-disconnect flow control
- Threaded hose connector
- Nylon belt (4612)

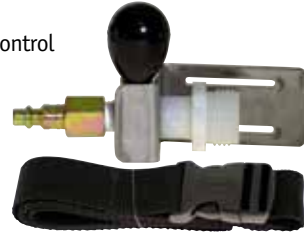

F41

Adjustable Flow control

- 1/4" Schrader quick-disconnect flow control
- Threaded hose connector
- Nylon belt (4612)



F42

Adjustable Flow control

- 1/4" Snap-Tite steel quick-disconnect flow control
- Threaded hose connector
- Nylon belt (4612)



F47

Adjustable Flow control Valve

- 1/4" CEJN stainless steel quick-disconnect flow control
- Threaded hose connector
- Nylon belt (4612)



88VX Series Replacement Valves for Breathing Tube Assemblies for use with Bullard Free-Air® Pumps

F35

Constant Flow control

- 1/2" Industrial Interchange (Hansen Compatible) quick-disconnect flow control
- Threaded hose connector
- Nylon belt (4612)



88VX Series Airline Respirator

88VX Series Replacement Parts for Breathing Tube Assemblies

4612 Nylon Belt



88VXBT Breathing Tube
• Flow control not included



88CK Breathing Tube Connector Kit
• Connector with sleeve
• Hardware
• Gasket
• "O" ring



88VX Series Airline Respirator

88VX Series Replacement Capes



46VX

28" Length Nylon Cape (Tan)

- Includes snap hooks
- Includes breathing tube straps
- Includes additional nylon liner in neck cuff area



Best Seller

13VX

38" Length Nylon Cape (Tan)

- Includes snap hooks
- Includes breathing tube straps
- Includes additional nylon liner in neck cuff area



21821

38" Length "Golden Gate" Nylon Cape (Tan)

- Cut-off cap sleeves
- Includes cinch straps/fabric ties
- Includes breathing tube straps
- Includes additional nylon liner in neck cuff area



36VX

38" Length Hibernia Parka (Tan)

36XLVX

38" Length Hibernia Parka Extra-Large Size (Tan)

- Nylon cape with long sleeves
- Includes belt straps
- Includes breathing tube straps
- Includes additional nylon liner in neck cuff area



Blasting and Grinding

88VX Series Airline Respirator

88VX Series Replacement Parts and Accessories

- 88VXRTP** Adjustable Ratchet Headband Suspension - Inner Shell/Air Plenum Included
- Poly brow pad
 - Flex-Gear®



-
- RBPCOTTON** Replacement Brow Pad, Cotton
- Absorbent cotton replacement brow pad
 - Fits all Bullard suspensions
 - Easy, Velcro® design



-
- RBPVINYL** Replacement Brow Pad, Vinyl
- Vinyl replacement brow pad
 - Fits all Bullard suspensions
 - Easy, Velcro® design



-
- RBPCOOL** Replacement Brow Pad, Cooling
- Polartec replacement brow pad
 - Wicking material moves sweat away from the worker's brow
 - Fits all Bullard suspensions
 - Easy, Velcro® design



-
- 20NC** Elastic Chinstrap
- 10 per package





88VX Series Airline Respirator

88VX Series Replacement Parts and Accessories

88CS Elastic Chinstrap

- For use with older model 88/88VX with riveted key hanger
- 10 per package
- latex-free



88CA Replacement Carrying Strap



88VXAK Maintenance Kit - Door/Gasket/Latch Assembly

- Includes 88VX Series door with latch, gasket, inner lens, bail, and hinge pin in a pre-assembled kit ready for mounting

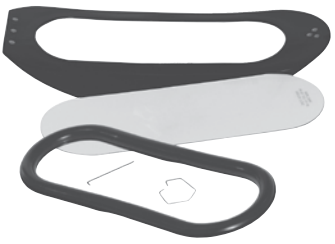

88VXRAK Rectangular Door Kit

- Includes 88VX Series door with latch, gasket, inner lens, bail, and hinge pin in a pre-assembled kit ready for mounting



88VXBAIL Replacement Bail for Latch Assembly

- 10 per package



88VXHP Replacement Hinge Pins for Latch Assembly

- 10 per package



GVXCP Replacement Cheek Pads

- One pair per package
- Velcro® attachment straps included



88VX Series Airline Respirator

88VX Series Replacement Parts and Accessories

-
- BFW** Box Front Window Frame
- Accommodates rectangular glass lens (77GLT)
 - Catch, bail and hinge pin in a pre-assembled kit; ready for mounting



-
- 77GLT** Box Front Glass Lens
- For use with 77BFW and BFW



-
- 77LG** Box Front Lens Gasket
- For use with 77BFW and BFW

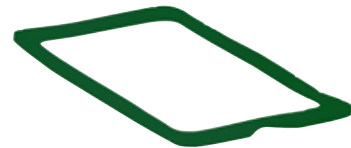

-
- G7713** 88VX Window Frame Gasket
- Oval gasket



-
- 88VX Series Mylar® Lens
- 7714** Adhesive-backed Mylar® Lens Cover
- Clear
 - Rectangular
 - 25 per package



-
- Perforated Edge Mylar® Lens Cover
- 88VXLC**
- Clear
 - 25 per package

- B88VXLC**
- Clear
 - 10 packages of 25



88VX Series Airline Respirator

88VX Series Replacement Lenses

Inner Lens

Tritan™, For Use with 77/88 Series

- MPT71B** • 10 per package
- P771B** • 25 per package
- B771B** • Eight packages of 25 lenses
- Oval
- .040" thick



B771B

Outer Lens

Acetate, For Use with 77/88 Series

- B771040** • Eight packages of 25 lenses
- Oval
- .040" thick



PETG, For Use with 77/88 Series

- MP771020** • 25 per package
- P771020** • 50 per package
- B771020** • 8 packages of 50 lenses
- Oval
- .020" thick



B771020

- B771R** • 50 packs of 10 each
- P771R** • 50 per package
- B771R015** • 10 packages of 50 lenses
- Rectangular
- .015" thick



B771R

- B771D015** • 10 packages of 50 lenses
- Rectangular
- .015" thick
- Protective film on both sides of lens



B771D015

PETG, For Use with 88VX Series

- B771R020** • Seven packages of 50 lenses
- Rectangular
- .020" thick



Tritan, For Use with 88VX Series

- 88VXOLT** • 25 per package
- Tinted Lens, Smoke
- .030" thick



Acetate, For Use with 88VX Series

- 88VXOLG** • 25 per package
- Tinted Lens, Green
- .042" thick



GR50 Series Airline Respirator

Enhanced Comfort and Protection for Grinding Operations

Offering both respiratory and dermal protection, the Bullard GR50 is the hood-style airline respirator designed especially to meet the challenges that are encountered in grinding operations. The lightweight outer hood, made from Dupont™ Nomex®, protects the operator's entire head, face, and neck from sparks and airborne particulates. The inner bib, made from flame-retardant cotton, is an added protective barrier. Applications in which the GR50 airline respirator can be used include grinding and metalworking.

For workers who use compressed breathing air, the Bullard GR50 is complete with Nomex respirator hood, breathing tube, and a choice of belt-mounted airline quick-disconnect fittings. The GR50 can also be used with convenient and low-cost Bullard Free-Air® pumps. Bullard V10 and V20 air supply hoses, sold separately, are available with point-of-attachment fittings for breathing air compressor systems or ambient air pumps.

Breathing Protection

Continuous airflow is delivered through a unique neck cuff, maintaining positive pressure inside the hood to help keep contaminants out.

Comfortable and Durable

Weighing only 12 oz. (340 g), the GR50 from Bullard is a lightweight alternative for workers accustomed to wearing heavier helmet-type respirators during grinding.

Head Protection and Climate Control Options

When worn with a Bullard hard hat, the hood meets ANSI/ISEA Z89.1-2014, Type I, requirements for protective headwear. A variety of climate control devices allow workers to cool incoming air to meet their comfort requirements, helping to boost productivity.

Flexible Hood and Window

For operations performed in tight spaces, the flexible hood and window enhance worker mobility. The inner window is made of .040" polycarbonate so it stands up to temperatures of up to 300°F.

No Fit-Testing

One size fits all, so fit-testing is not required. The hood easily accommodates beards, hearing protection, prescription eyewear, or safety glasses.

Maximum Visibility

Wide-angle faceshield and headband suspension system are positioned to create the maximum viewing area. Replacement outer lens helps protect inner lens from sparks and debris, extending the usable life of the product.



GR50 Series Airline Respirator

GR50 Series Airline Respirator Selection Chart

1. Choose Head Top



• **GRH** - Nomex® Grinding Hood



• **20RT** - Adjustable Ratchet Headband Suspension



• **C30P** - Self-Sizing 6-point Pinlock Suspension, Full-Profile
• **C30R** - 6-point Flex-Gear® Ratchet Suspension



• **S51P** - Self-Sizing 4-point Pinlock Suspension, Low-Profile
• **S51R** - 4-point Flex-Gear® Ratchet Suspension

3. Choose Breathing Tube



• **20BT** - Breathing Tube for Hoods

4. Choose Flow control Device



1/4" Continuous Flow

- **F30, F30B, F30S** - Industrial Interchange (Hansen Compatible)
- **F31** - Schrader
- **F32** - Snap-Tite Steel
- **F33** - Snap-Tite Brass
- **F34** - Snap-Tite Stainless
- **F35, F35B** - 1/2" Industrial Interchange for Free-Air® Pumps
- **F37** - CEJN

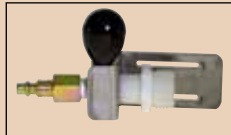

1/4" Adjustable Flow

- **F40, F40B, F40S** - Industrial Interchange (Hansen Compatible)
- **F41** - Schrader
- **F42** - Snap-Tite Steel
- **F43** - Snap-Tite Brass
- **F44** - Snap-Tite Stainless
- **F47** - CEJN



Cool Tubes for Compressed Air

- **AC100030, AC100030B, AC100030S** - 1/4" Industrial Interchange (Hansen Compatible)
- **AC100031** - Schrader
- **AC100032** - Snap-Tite Steel
- **AC100033** - Snap-Tite Brass
- **AC100034** - Snap-Tite Stainless
- **AC100037** - CEJN



Cool Tubes for Free-Air® Pumps

- **FRIGITRON2000** - 1/2" Industrial Interchange (Hansen Compatible)
- **FRIGITRON2000B** - Brass



Hot/Cold Tubes

- **HC240030, HC240030B, HC240030S** - 1/4" Industrial Interchange (Hansen Compatible)
- **HC240031** - Schrader
- **HC240032** - Snap-Tite Steel
- **HC240033** - Snap-Tite Brass
- **HC240034** - Snap-Tite Stainless
- **HC240037** - CEJN

5. Choose Cooling Vest



- **DC70ML** - Med/Lg Cool Vest
- **DC70XLXXL** - XL/XXL Cool Vest
- **DC705X** - 5XL Cool Vest

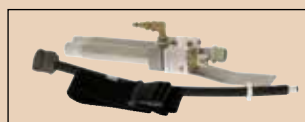

- **DC5040** - Dual-Cool Industrial Interchange (Hansen Compatible)
- **DC5041** - Dual-Cool Schrader
- **DC5042** - Dual-Cool Snap-Tite Steel
- **DC5047** - Dual-Cool CEJN



• **4612** - Nylon Belt



• **20NC** - Chinstrap



• **MB1** - PETG Outer Lens



• **GRH01** - Polycarbonate Outer Lens

GR50 Airline Respirator

GR50 Airline Respirator Systems

Bullard's GR50 Airline Respirator consists of four components, all of which must be present and properly assembled to constitute a complete NIOSH-approved respirator. Approval Number TC-19C-329, Type C.

1. Respirator Hood
2. Headband or Head Protection
3. Breathing Tube Assembly
4. Air Supply Hose

- Meets ANSI/ISEA Z89.1-2014 Head Protection Requirements when used with Bullard Hard Hats
- Meets ANSI/ISEA Z87.1-2015, Z87+ Face Protection Requirements (High Impact Penetration)

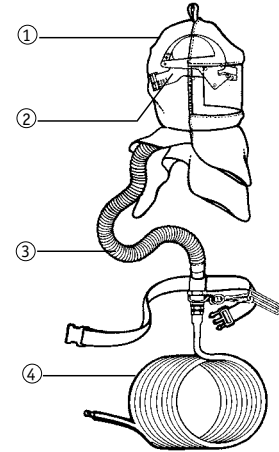

- GR5030** Constant Flow Respirator with V30 Breathing Tube Assembly
- GRH hood
 - 20RT suspension
 - F30 1/4" Industrial Interchange (Hansen compatible) quick-disconnect flow control and nylon belt
 - Outer lens
 - For use with compressed air



- GR50SYS** GR50 Series Airline Respirator System
- GR5035 respirator assembly
 - EDP10 Free-Air® pump
 - V20100ST air supply hose



- GR50ICESYS** GR50 Series Airline Respirator System
- GR5035 respirator assembly
 - ICEPump11 pump
 - V20100ST air supply hose
 - FRIGITRON2000



- GR5035** Constant Flow Respirator with V35 Breathing Tube Assembly
- GRH hood
 - 20RT suspension
 - F35 1/2" industrial interchange (Hansen compatible) quick-disconnect flow control and nylon belt
 - Outer lens
 - For use with Bullard Free-Air® pumps



GR50 Airline Respirator

GR50 Airline Respirator Replacement Respirator Hood

- GRH** Nomex Grinding Hood
- Includes outer lens
 - 12" long outer bib



GR50 Airline Respirator Replacement Parts

- 20RT** Adjustable Flex-Gear® Ratchet Headband Suspension
- Poly brow pad
 - Fits sizes 6½" to 8" (52-64 mm)



- 20TG** Adjustable Pinlock Headband Suspension
- Poly brow pad
 - Fits sizes 6½" to 8" (52-64 mm)

- 20NC** Elastic Chinstrap
- 10 per package



- RBPCOTTON** Replacement Brow Pad, Cotton
- Absorbent cotton replacement brow pad
 - Fits all Bullard suspensions
 - Easy, Velcro® design



- RBPVINYL** Replacement Brow Pad, Vinyl
- Vinyl replacement brow pad
 - Fits all Bullard suspensions
 - Easy, Velcro® design



- RBPCOOL** Replacement Brow Pad, Cooling
- Polartec replacement brow pad
 - Wicking material moves sweat away from the worker's brow
 - Fits all Bullard suspensions
 - Easy, Velcro® design



GR50 Airline Respirator

GR50 Head Protection

C30R

Hard Hat for use with 20TICH, 20SICH, GRH

- High-density polyethylene shell
- Full-profile, wide brim
- Accessory slots for attachments
- 6-point Flex-Gear® ratchet suspension with large, absorbent cotton brow pad (RS6RC)
- Replacement brow pads available (RBPCOTTON, RBPVINYL, RBPCOOL)
- Meets or exceeds ANSI/ISEA Z89.1-2014, Type I, Class E & G requirements and CSA Z94.1-2005, Type 1, Class E & G requirements
- Case quantity: 20; minimum order: 20



S51R

Hard Hat for use with 20TICH, 20SICH, GRH

- High-density, polyethylene shell with flat front, low-profile design
- Accessory slots for cap attachments
- Rain trough brim
- 4-point Flex-Gear® ratchet suspension with poly (RS4RP) or vinyl (RS4RB) brow
- Replacement brow pads available (RBPCOTTON, RBPVINYL, RBPCOOL)
- Meets or exceeds ANSI/ISEA Z89.1-2014, Type I, Class E & G requirements and CSA Z94.1-2005, Type 1, Class E & G requirements, and EN 397:2012 requirements
- Case quantity: 20; minimum order: 20



GR50 Airline Respirator

GR50 Head Protection Replacement Parts

RS6RC

6-pt. Suspension

- 6-point Flex-Gear® ratchet suspension
- Large, absorbent cotton brow pad
- Replacement brow pads available (RBPCOTTON, RBPVINYL, RBPCOOL)
- Flex-points and nape cushion
- Large, easy-to-turn ratchet knob
- Vertical height adjustments (two front, three rear)
- For Models C30, C33, and C34

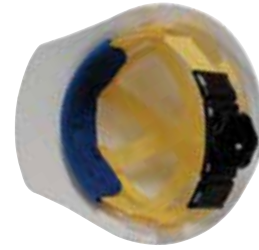

RS4RC

4-pt. Suspension

- 4-point Flex-Gear® ratchet suspension
- Large, absorbent cotton brow pad
- Replacement brow pads available (RBPCOTTON, RBPVINYL, RBPCOOL)
- Flex-points and nape cushion
- Large, easy-to-turn ratchet knob
- For Models S51, S61, S62, and S71



ES42

2-Point Elastic Chinstrap, Natural

- Latex-free, natural elastic
- For Models S51, S61, S62, S71, C30, C33, C34, 911C, 911H, and Bump Cap



GR50 Airline Respirator

GR50 Airline Respirator Breathing Tubes & Parts

- V30** Constant Flow Breathing Tube Assembly
- 20BT breathing tube
 - F30 1/4" Industrial Interchange (Hansen Compatible) quick-disconnect flow control
 - Nylon belt (4612)
 - Clamp (S18051)
 - For use with compressed air



- V40** Adjustable Flow Breathing Tube Assembly
- 20BT breathing tube
 - F40 1/4" Industrial Interchange (Hansen Compatible) quick-disconnect flow control with adjustable flow control valve
 - 4612 nylon belt
 - S18051 clamp
 - For use with compressed air



- V35** Constant Flow Breathing Tube Assembly
- 20BT breathing tube
 - F35 1/2" Industrial Interchange (Hansen Compatible) quick-disconnect flow control
 - 4612 nylon belt
 - S18051 clamp
 - For use with Bullard Free-Air® pumps



- F30** Constant Flow control Valve
- 1/4" Industrial Interchange (Hansen Compatible) quick-disconnect flow control
 - Threaded hose connector
 - 4612 nylon belt
 - For use with compressed air
 - F30B 1/4" Industrial Interchange, Brass
 - F30S 1/4" Industrial Interchange, Stainless



- F31** Constant Flow control Valve
- 1/4" Industrial Interchange Schrader quick-disconnect flow control
 - Threaded hose connector
 - 4612 nylon belt
 - For use with compressed air



- F32** Constant Flow control Valve
- 1/4" Industrial Interchange Snap-Tite quick-disconnect flow control
 - Threaded hose connector
 - 4612 nylon belt
 - For use with compressed air



GR50 Airline Respirator

GR50 Airline Respirator Breathing Tubes & Parts

F33

Constant Flow Control Valve

- 1/4" Industrial Interchange Snap-Tite, brass quick-disconnect flow control
- Threaded hose connector
- 4612 nylon belt
- For use with compressed air



F34

Constant Flow Control Valve

- 1/4" Industrial Interchange Snap-Tite, stainless quick-disconnect flow control
- Threaded hose connector
- 4612 nylon belt
- For use with compressed air



F37

Constant Flow Control Valve

- 1/4" Industrial Interchange CEJN quick-disconnect flow control
- Threaded hose connector
- 4612 nylon belt
- For use with compressed air



F40

Adjustable Flow Control Valve

- 1/4" Industrial Interchange (Hansen Compatible) quick-disconnect flow control
- Threaded hose connector
- 4612 nylon belt
- For use with compressed air



F35

Constant Flow Control Valve

- 1/2" Industrial Interchange (Hansen Compatible) quick-disconnect flow control
- Threaded hose connector
- 4612 nylon belt
- For use with Bullard Free-Air® pumps



20BT

Breathing Tube

- Flow control not included
- Clamp (S18051)



GR50 Airline Respirator

GR50 Airline Respirator Replacement Parts & Accessories

S18051 Breathing Tube Clamp
• 10 per package



S18051BLACK Breathing Tube Clamp, Black
• 10 per package



4612 Nylon Belt



MB1 PETG Outer Lens
• .020" thick
• 10 per package



GRHOL1 Polycarbonate Outer Lens
• .040" thick
• 10 per package



20LC Adhesive-Backed Mylar® Lens Cover
• Clear
• 25 per package



7714 Adhesive-Backed Mylar® Lens Cover
• Clear
• Rectangular
• 25 per package



Mask-Style Respirators Spectrum Series®

Comfort, Low Profile, Outstanding Visibility, Simplicity

Finally, there's a respirator that fits — your face, your needs, and your high expectations. Integrating intelligent features with innovative design, Bullard takes respiratory protection to a whole new level. The Spectrum Series® offers outstanding comfort, low-profile fit, unparalleled visibility, simplicity, and 1,000 Assigned Protection Factor (APF).

With the Spectrum Series®, Bullard can meet all of a customer's airline respirator needs — from continuous flow tight-fitting facepieces to escape Self-Contained Breathing Apparatus (ESCBAs) respirators. The four models in the Spectrum Series® include:

- Continuous flow
- Pressure demand
- Pressure demand with 5-minute cylinder
- Pressure demand with 10-minute cylinder

Spectrum Protection

- NIOSH Approval TC #19C-0505, 0506, 0507, 0508, 0509, 0510
- 1,000 Assigned Protection Factor (APF)
- ANSI/ISEA Z87.1, Z87+ Impact Face Protection

Spectrum Comfort

- Lightweight silicone flange seals softly against the user's face without feeling slippery
- Double flange provides a secure, comfortable fit across a wide range of facial sizes and contours
- Multiple size options

Spectrum Low Profile

- Allows user to get close to their work
- Allows user to fit into tight spaces
- Reduces snag hazards
- Compatible with hard hat donning

Spectrum Visibility

- Optically correct lens provides superior peripheral vision
- Clear nose cup allows more light into the mask, minimizing the closed-in feeling prevalent in other masks
- Mylar® Lens covers keep the lens clean and protected

Spectrum Simplicity

- Snap-together parts make assembly and maintenance quick and efficient without requiring special tools
- A single facepiece platform design allows for conversion to other respirator configurations

Spectrum Versatility

- The Spectrum Full-Face mask allows for multiple configurations:
 - PAPR (with the Bullard EVA)
 - Continuous Flow - Ambient Air Pump
 - Continuous Flow - Compressed Air
 - Pressure Demand - Compressed Air

Mask-Style Respirators Spectrum Series® Full-Facepiece

Features	Benefits
Low Profile	Fits under welding helmets
1,000 APF	100X the protection of APR Half Mask
Polycarbonate Lens	ANSI/ISEA Z87+ Face Protection Great optics for clear vision
Silicone Straps & Flange Seals	Highest Comfort
Nosecup	Improved Comfort Prevents Fogging Clear design for improved visibility
Speaker Diaphragm	Improved communication
Reusable	Low total cost of ownership
No Cartridges Required	Low total cost of ownership
PAPR: Powered Air Purifying Respirator SAR: Supplied Air Respirator PD: Pressure Demand	Multiple configurations allow the user to buy a single platform for many applications

Applications

Painting and Coating Operations, Spray Foam Insulation, Remediation, Chemical Handling, Confined Space (with Escape bottle)



Mask-Style Respirators Spectrum Series® Full-Facepiece

Mask-Style Respirators Spectrum Series® Full-Facepiece

1. Choose Supplied Air Mode

Continuous Flow

Most popular configuration is SPEC40L (air supply hose not included)

Pressure Demand

Most popular configuration is SPECPLA (air supply hose not included)

Pressure Demand with Escape Bottle

Most popular configuration is SPECPE10L (air supply hose not included)

2. Choose Mask Size



- SPECFFML - Medium/Large
- SPECFFS - Small



- SPECDFML - Medium/Large
- SPECDFS - Small

3. Add Breathing Tube



- SPECBT - Spectrum Breathing Tube

4. Choose Flow Control/Regulator Assembly



1/4" Constant Flow

- F30, F30B, F30S Industrial Interchange (Hansen Compatible)
- F31 - Schrader
- F32 - Snap-Tite Steel
- F33 - Snap-Tite Brass
- F34 - Snap-Tite Stainless
- F37 - CEJN
- F38 - Bayonet Steel



1/2" Constant Flow

- F35, F35B, for Free-Air® Pumps Constant Flow control Valve, 1/2" Industrial Interchange (Hansen Compatible)

4. Choose Flow control/Regulator Assembly Continued

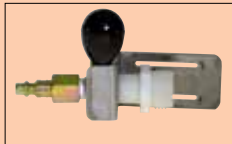

1/4" Adjustable Flow

- F40, F40B, F40S Industrial Interchange (Hansen Compatible)
- F41 - Schrader
- F42 - Snap-Tite Steel
- F43 - Snap-Tite Brass
- F44 - Snap-Tite Stainless
- F47 - CEJN
- F48 - Bayonet Steel

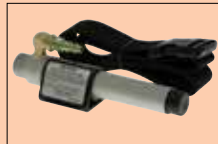

Cool Tubes for Compressed Air (Metal)

- AC100030, AC100030B, AC100030S 1/4" Industrial Interchange (Hansen Compatible)
- AC100031 - Schrader
- AC100032 - Snap-Tite Steel
- AC100033 - Snap-Tite Brass
- AC100034 - Snap-Tite Stainless
- AC100037 - CEJN
- AC100038 - Bayonet Steel



Cool Tubes for Compressed Air (Plastic)

- CT30, CT30B, CT30S 1/4" Industrial Interchange (Hansen Compatible)
- CT30SW, CT30BSW, CT30SSW 1/4" Industrial Interchange with Dynaswivel fitting
- CT31 - Schrader
- CT32 - Snap-Tite Steel
- CT33 - Snap-Tite Brass
- CT34 - Snap-Tite Stainless
- CT37 - CEJN
- CT38 - Bayonet Steel



Hot/Cold Tubes for Compressed Air (Metal)

- HC240030, HC240030B, HC240030S 1/4" Industrial Interchange (Hansen Compatible)
- HC240031 - Schrader
- HC240032 - Snap-Tite Steel
- HC240033 - Snap-Tite Brass
- HC240034 - Snap-Tite Stainless
- HC240037 - CEJN
- HC240038 - Bayonet Steel



Hot/Cold Tubes for Compressed Air (Plastic)

- HCT30, HCT30B, HCT30S 1/4" Industrial Interchange (Hansen Compatible)
- HCT30SW, HCT30BSW, HCT30SSW 1/4" Industrial Interchange with Dynaswivel fitting
- HCT31 - Schrader
- HCT32 - Snap-Tite Steel
- HCT33 - Snap-Tite Brass
- HCT34 - Snap-Tite Stainless
- HCT37 - CEJN
- HCT38 - Bayonet Steel

4. Choose Flow control/Regulator Assembly Continued



- PDR45 - Second stage regulator with Bypass including CA30 Industrial Interchange (Hansen Compatible) coupler
- BHA - Belt/Harness Assembly

Optional Couplers:

- CA30S - 1/4" Industrial Interchange Stainless
- CA31 - 1/4" Schrader
- CA32 - 1/4" Snap-Tite
- CA33 - 1/4" Snap-Tite Brass
- CA34 - 1/4" Snap-Tite Stainless
- CA37 - 1/4" CEJN



- RA45B - First and second regulator with bypass including CA30 Industrial Interchange (Hansen Compatible) coupler
- BHA - Belt/Harness Assembly

Optional Couplers:

- CA30S - 1/4" Industrial Interchange Stainless
- CA31 - 1/4" Schrader
- CA32 - 1/4" Snap-Tite
- CA33 - 1/4" Snap-Tite Brass
- CA34 - 1/4" Snap-Tite Stainless
- CA37 - 1/4" CEJN

5. Choose Escape Bottle



• CYL5H - 5 Minute



• CYL10H - 10 Minute

6. Choose Accessories



- PL - Spectacle Frame Assembly



- LC - Mylar® Lens Covers



- AFW45 - Anti-Fog Lens Wipes



- QNFT45 - Quantitative Fit Test Kit

7. Choose Air Supply Hose

- See pages 194-200

Spectrum Series®

Spectrum Series® Continuous Flow Replacement Parts

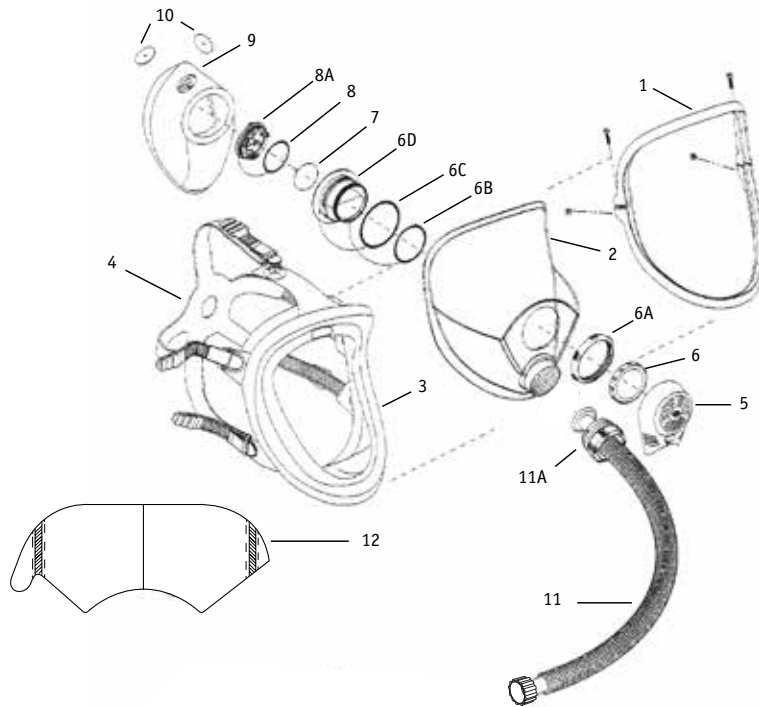

Cat. No.	Description	Cat. No.	Description
1. LCK	Lens Clamp Replacement	8. EVO (includes parts listed)	O-ring for Exhalation Valve Seat
2. RLS	Replacement Lens	8A	Exhalation Valve Seat
3. FKML & FKS	Facepiece Flange	9. LNK	Nose Cup
4. HSK	Headstrap with Buckles and Slides	10. SPECIVK	Inhalation Valve Flaps
5. MCK	Mask Cover	11. SPECBT	Breathing Tube Assembly
6. SEK (includes parts listed)	Speaker Diaphragm	11A	Breathing Tube Adapter
6A	Outer Locking Ring	12. LC	Mylar® Lens Covers
6B	O-ring Speaker Diaphragm		
6C	O-ring Speaker/Exhalation		
6D	Speaker/Exhalation Body		
7. 6059	Exhalation Valve		

Continuous Flow Airline Respirator

A complete Spectrum Series® Continuous Flow Airline Respirator consists of the following three components:

1. Full-Facepiece
2. Breathing Tube Assembly
3. Breathing Air Supply Hose

All three Bullard components must be present and properly assembled to constitute a NIOSH approved respirator.

Approval No. TC-19C-322, Type C, Continuous Flow Class



Spectrum Series® Continuous Flow Airline Respirator

- SPEC40ICESYS** Spectrum Series® Airline Respirator System with ICE Pump
- Respirator assembly (SPEC40L)
 - ICEPump11 pump
 - 100' air supply hose (4696100)
 - Climate Control Device (AC1000)
 - 1/4" Industrial Interchange QD Coupler



SPEC40ICESYS

- SPECLSYS** Spectrum Series® Airline Respirator System with Free-Air® Pump
- Respirator assembly (SPEC35L)
 - Free-Air® pump (EDP10)
 - 100' air supply hose (V20100ST)
 - Lens covers (LC)



SPECLSYS

-  **SPECLSYS2M** 2-Worker Spectrum Series® Airline Respirator System with Free-Air® Pump
- Same as above with additional SPEC35L and 100' air supply hose (V20100ST)

- SPECLSYS50** Same as SPECLSYS with 50' air supply hose (V2050ST)

-  **SPECLCABSYS** Spectrum Series® Airline Respirator System with Clean Air Box
- Respirator assembly (SPEC40L)
 - 15 cfm Clean Air Box (CAB15HA)
 - 100" air supply hose (4696100)
 - Lens covers (LC)
 - Anti-fog wipes

- SPECLCABSYS2M** 2-Worker Spectrum Series® Airline Respirator System with Clean Air Box
- 2 Masks (SPEC40L)
 - 30 cfm Clean Air Box
 - 2 Breathing Tubes
 - 2 100" air supply hose (4696100)
 - Lens covers (LC)
 - Anti-fog wipes



SPECLCABSYS

-  Spectrum Series®-CF Respirator Assembly
- SPEC40L** Medium/Large Facepiece (SPEC40L)
- SPEC40S** Small Facepiece (SPEC40S)
- Breathing tube assembly with 1/4" Industrial Interchange (Hansen compatible) flow control, adjustable flow control valve (SPECBT) and nylon belt (4612)
 - For use with compressed air



- Spectrum Series®-CF Respirator Assembly for use with Bullard Free-Air® Pump
- SPEC35L** Medium/Large Facepiece (SPEC35L)
- SPEC35S** Small Facepiece (SPEC35S)
- Breathing tube assembly with 1/2" Industrial Interchange (Hansen compatible) flow control (SPECBT) and nylon belt (4612)
 - For use with Bullard Free-Air® pumps



 Best Seller

Spectrum Series® Airline Respirator

Continuous Flow Breathing Tubes

- SPECBT** Breathing Tube for Spectrum Series®
- Flow control device not included



Continuous Flow Facepieces

- SPECCFML** Medium/Large Facepiece Assembly
SPECCFS Small Facepiece Assembly
- Complete with facepiece, lens, head straps, exhalation valve, and facepiece components
 - For use only with SPEC-CF respirators



Spectrum Series® Replacement Valves for Breathing Tube Assemblies for use with Compressed Air

- F30** Constant Flow Control
- 1/4" Industrial Interchange (Hansen compatible) quick-disconnect flow control
 - Threaded hose connector
 - Nylon belt (4612)



- F31** Constant Flow Control
- 1/4" Schrader quick-disconnect flow control
 - Threaded hose connector
 - Nylon belt (4612)



- F32** Constant Flow control
- 1/4" Snap-Tite steel quick-disconnect flow control
 - Threaded hose connector
 - Nylon belt (4612)



- F33** Constant Flow Control
- 1/4" Snap-Tite brass quick-disconnect flow control
 - Threaded hose connector
 - Nylon belt (4612)



Spectrum Series® Airline Respirator

Spectrum Series® Replacement Valves for Breathing Tube Assemblies for use with Compressed Air

- F37** Constant Flow Control
- 1/4" CEJN steel quick-disconnect flow control
 - Threaded hose connector
 - Nylon belt (4612)



- F38** Constant Flow Control Valve
- 1/4" Bayonet steel quick-disconnect flow control
 - Threaded hose connector
 - Nylon belt (4612)
 - No ball bearings to "clog" with grit



Spectrum Series® Replacement Valves for Breathing Tube Assemblies for use with Compressed Air

- F40** Adjustable Flow Control
- 1/4" Industrial Interchange (Hansen Compatible) quick-disconnect flow control
 - Threaded hose connector
 - Nylon belt (4612)

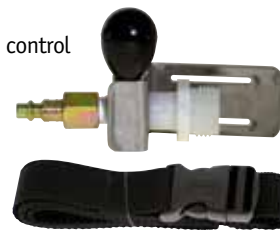

- F41** Adjustable Flow Control
- 1/4" Schrader quick-disconnect flow control
 - Threaded hose connector
 - Nylon belt (4612)



- F42** Adjustable Flow Control
- 1/4" Snap-Tite steel quick-disconnect flow control
 - Threaded hose connector
 - Nylon belt (4612)



- F47** Adjustable Flow Control Valve
- 1/4" CEJN stainless steel quick-disconnect flow control
 - Threaded hose connector
 - Nylon belt (4612)



Spectrum Series®

Spectrum Series® Replacement Valves for Breathing Tube Assemblies for use with Bullard Free-Air® Pumps

F35

Constant Flow Control

- ½" Industrial Interchange (Hansen Compatible) quick-disconnect flow control
- Threaded hose connector
- Nylon belt (4612)



Spectrum Series® Facepiece Components

RAK

Facepiece Components

- O-ring for regulator adapter
- Regulator adapter
- Lens port gasket
- For use with SPEC-PD



EVPDK

Exhalation Valve Kit

- Spring retainer
- Spring
- Plate
- Exhalation valve flap and stem



LNK

Replacement Nose Cup

- Includes 2 inhalation valve flaps



RLS

Replacement Lens



LCK

Lens Clamp Replacement Kit

- Upper and lower clamps
- Screws and nuts



SPECIVK

Inhalation Valve Kit

- Includes five inhalation valve flaps





Spectrum Series®

Spectrum Series® Continuous Flow Facepiece Components

FKML FKS	Medium/Large Facepiece Flange Small Facepiece Flange	
---------------------------	---	--

6059	Exhalation Valve Kit <ul style="list-style-type: none"> • Continuous flow versions only • Includes five exhalation valve flaps 	
-------------	--	--

HSK	Headstrap Kit <ul style="list-style-type: none"> • Includes 5 buckles and five slides 	
------------	--	--

MCK	Mask Cover <ul style="list-style-type: none"> • Includes 5 inhalation valve flaps 	
------------	--	--

SEK	Speaker/Exhalation Kit <ul style="list-style-type: none"> • Speaker/exhalation body • Speaker diaphragm • Outer locking ring • O-ring for speaker diaphragm • O-ring for speaker/exhalation body 	
------------	---	--

EVO	Exhalation Valve Seat and O-Ring	
------------	----------------------------------	--

PL	Spectacle Frame Assembly	
-----------	--------------------------	--

Spectrum Series®

Spectrum Series® Continuous Flow Facepiece Components

- LC** Mylar® Lens Covers
- 25 per package



- AFW45** Anti-Fog Lens Wipes
- 10 per package



Spectrum Series® Fit Testing Accessories: Continuous Flow

- QNFT45** Quantitative Fit Test Kit
- Fit test adapter
 - Facepiece sampling adapter
 - 3/8" barbed mask probe
 - 1 HEPA filter cartridge



- FTR45** Fit Test Refill Kit
- 15 feet of Tygon® tubing
 - 25 suction cups and 25 clips



- HFC45** Replacement HEPA Filter Cartridges
- For quantitative or qualitative fit testing (except for isoamyl acetate)
 - 4 per carton



Spectrum Series®

Pressure Demand Airline Respirator

A complete Spectrum Series® Pressure Demand (PD) Airline Respirator consists of the following four components:

1. Full-Facepiece
- 2a. Second Stage Regulator Assembly (Pressure Demand Only)
- 2b. First and Second Stage Regulator Assembly (Pressure Demand with Egress Only)
- 3a. Harness Assembly
- 3b. Harness Assembly Including 5- or 10-minute Cylinder (PDE Only)
4. Air Supply Hose

All four Bullard components must be present and properly assembled to constitute a NIOSH approved respirator.

SPEC-PD Approval No. TC-19C-354, Type C, Pressure Demand Class

SPEC-PDE-5 Approval No. TC-13F-387, Combination SCBA and Type C Pressure Demand Class

SPEC-PDE-10 Approval No. TC-13F-388, Combination SCBA and Type C Pressure Demand Class



Spectrum Series® PD Respirator Assembly

- SPECPLA** Medium/Large Facepiece (SPECPLML)
SPECPSA Small Facepiece (SPECPS)
• Pressure demand regulator (PDR45)
• Belt harness assembly (BHA)
• Coupler assembly (CA30)



Spectrum Series® PDE5 Respirator Assembly

- SPECPE5L** Medium/Large Facepiece (SPECPLML)
SPECPE5S Small Facepiece (SPECPS)
• Regulator assembly (including 1st and 2nd stage regulators with bypass) (RA45B)
• Belt harness assembly (including 5-minute ESCBA cylinder) (BHA)
• Coupler assembly (CA30)



Spectrum Series® PDE10 Respirator Assembly

- SPECPE10L** Medium/Large Facepiece (SPECPLML)
SPECPE10S Small Facepiece (SPECPS)
• Regulator assembly (including 1st and 2nd stage regulators with bypass) (RA45B)
• Belt harness assembly (including 10-minute ESCBA cylinder) (BHA)
• Coupler assembly (CA30)



Spectrum Series®

Spectrum Series® Pressure Demand Facepiece Replacement Parts

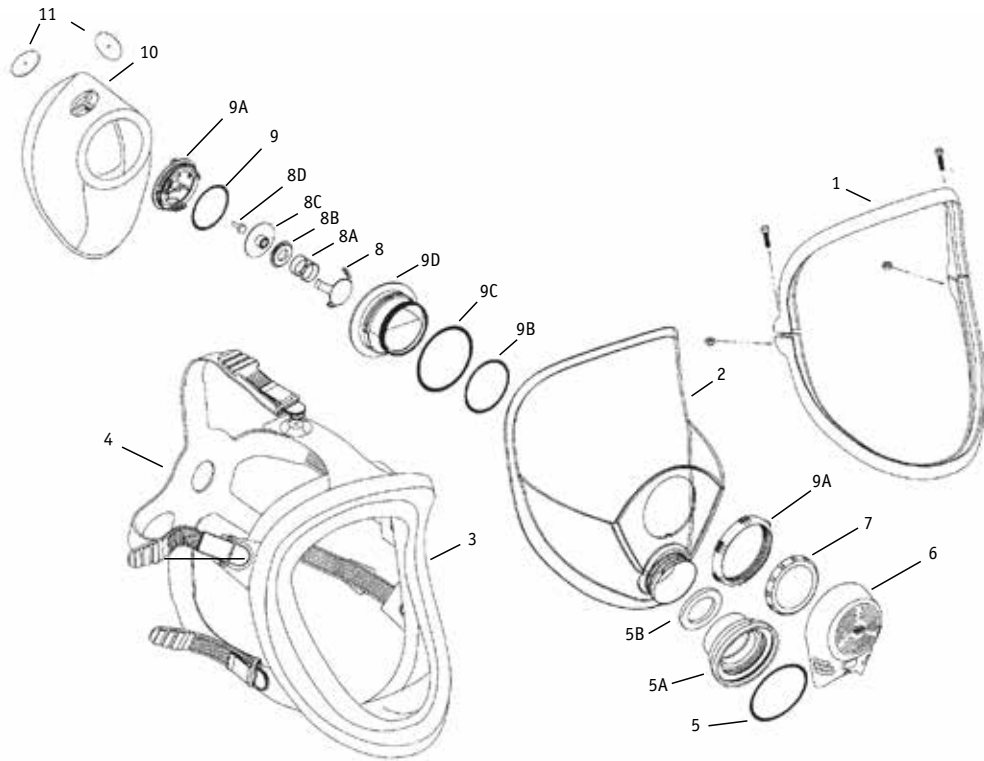

Cat. No.	Description	Cat. No.	Description
1. LCK	Lens Clamp	8. EVPDK (includes parts listed)	Spring Retainer
2. RLS	Replacement Lens	8A	Spring, PD
3. FKML & FKS	Facepiece Flange	8B	Plate
4. HSK	Headstrap with Buckles & Slides	8C	Exhalation Valve Flap
5. RAK (includes parts listed)	O-ring, Regulator Adapter	8D	Stem
5A	Regulator Adapter	9. EVO (includes parts listed)	O-ring for Exhalation Valve Seat
5B	Gasket, Lens Port	9A	Exhalation Valve Seat
6. MCK	Mask Cover	10. LNK	Nose Cup
7. SEK	Speaker Diaphragm	11. SPECIVK	Inhalation Valve Flap

Spectrum Series®

Spectrum Series® Pressure Demand Regulators and Cylinders

- FSR45** First Stage Regulator
- Includes CA30 coupler assembly
 - For use only with SPEC-PDE respirators



- RA45B** First Stage Regulator and Second Stage Regulator with Bypass
- Includes CA30 coupler assembly
 - For use only with SPEC-PDE



- PDR45** Second Stage Regulator without Bypass
- Includes CA30 coupler assembly
 - For use only with SPEC-PD respirator



- PDR45B** Second Stage Regulator with Bypass
- Includes CA30 coupler assembly
 - For use only with SPEC-PDE



- CYL455** 5-Minute Escape Cylinder with Valve
- Additional shipping charges may apply



- CYL4510** 10-Minute Escape Cylinder with Valve
- Additional shipping charges may apply



- CYL5H** 5-Minute Escape Cylinder with Valve and Holster
- For use with SPEC-PDE5L
 - Additional shipping charges may apply



- CYL10H** 10-Minute Escape Cylinder with Valve and Holster
- For use with SPEC-PDE10L
 - Additional shipping charges may apply

CYL5H



Spectrum Series®

Spectrum Series® Pressure Demand Coupler Assemblies

- CA30** 1/4" Industrial Interchange Quick-Disconnect Coupler Assembly
- Male threaded (Hansen compatible) nipple
 - Female threaded coupler with ball lock and adapter, which connects the respirator to the airline extension hose



CA30

- CA30S** 1/4" Industrial Interchange, Stainless, Quick-Disconnect Coupler Assembly
- Male threaded (Hansen compatible) nipple
 - Female threaded coupler with ball lock and adapter, which connects the respirator to the airline extension hose

-
- CA31** 1/4" Schrader Quick-Disconnect Coupler Assembly
- Male threaded nipple
 - Female threaded coupler with adapter, which connects the respirator to the airline extension hose



-
- CA32** 1/4" Snap-Tite Steel Quick-Disconnect Coupler Assembly
- Male threaded nipple
 - Female threaded coupler with adapter, which connects the respirator to the airline extension hose



-
- CA33** 1/4" Snap-Tite Brass Quick-Disconnect Coupler Assembly
- CA34** 1/4" Snap-Tite Stainless Steel Quick-Disconnect Coupler Assembly
- Male threaded nipple
 - Female threaded coupler with adapter, which connects the respirator to the airline extension hose



CA33

-
- CA37** 1/4" CEJN Steel Quick-Disconnect Coupler Assembly
- Male threaded nipple
 - Female threaded coupler with special orifice adapter, which connects the respirator to the airline extension hose
 - Use only with orifice adapter



Spectrum Series®

Spectrum Series® Pressure Demand Accessories

- BHA** Replacement Shoulder Harness
- Fire Retardant nylon belt (4611)
 - Buckle connector
 - Shoulder strap



- 4611** Fire Retardant Nylon Belt



Spectrum Series®

Spectrum Series® Pressure Demand Components

- SPECMDML** Medium/Large Facepiece Assembly
SPECSDS Small Facepiece Assembly
- Complete with facepiece, lens, head straps, exhalation valve, and facepiece components
 - For use with SPEC-PD respirators



- RAK** Facepiece Components
- O-ring for regulator adapter
 - Regulator adapter
 - Lens port gasket
 - For use with SPEC-PD



- EVPDK** Exhalation Valve Kit
- Spring retainer
 - Spring
 - Plate
 - Exhalation valve flap and stem



- LNK** Replacement Nose Cup
- Includes 2 inhalation valve flaps



- RLS** Replacement Lens



Spectrum Series®

Spectrum Series® Pressure Demand Facepiece Components

LCK

- Lens Clamp Replacement Kit
- Upper and lower clamps
 - Screws and nuts



SPECIVK

- Inhalation Valve Kit
- Includes 5 inhalation valve flaps



FKML
FKS

- Medium/Large Facepiece Flange
Small Facepiece Flange



Spectrum Series®

Spectrum Series® Pressure Demand Facepiece Components

- HSK** Headstrap Kit
- Includes 5 buckles and five slides



- MCK** Mask Cover
- Includes 5 inhalation valve flaps



- SEK** Speaker/Exhalation Kit
- Speaker/exhalation body
 - Speaker diaphragm
 - Outer locking ring
 - O-ring for speaker diaphragm
 - O-ring for speaker/exhalation body



- EVO** Exhalation Valve Seat and O-Ring



- PL** Spectacle Frame Assembly



- LC** Mylar® Lens Covers
- 25 per package



- AFW45** Anti-Fog Lens Wipes
- 10 per package



Spectrum Series®

Spectrum Series® Fit Testing Accessories: Pressure Demand

QNFT45

Quantitative Fit Test Kit

- Fit test adapter
- Facepiece sampling adapter
- 1/8" barbed mask probe
- One HEPA filter cartridge



FTR45

Fit Test Refill Kit

- 15 feet of Tygon® tubing
- 25 suction cups and 25 clips



HFC45

Replacement HEPA Filter Cartridges

- For quantitative or qualitative fit testing (except for isoamyl acetate)
- 4 per carton



FAMB2 Half-Mask Airline Respirator

A Comfortable Positive Pressure Airline Respirator

The Bullard FAMB2 presents a simple means of supplying clean air to workers. Available with both pressure demand and continuous flow approvals, FAMB2 provides continuous airflow to workers operating in environments that are contaminated with dust, mists, gases, and vapors.

FAMB2 airline respirators are NIOSH-approved for use in Type C applications, including:

- Spray painting and coating operations
- Chemical and pesticide handling
- Wood finishing
- Welding

FAMB2 Comfort

The Bullard FAMB2 half-mask, available in three sizes, features a soft, flexible silicone facepiece that conforms to the worker's face. The double exhalation valve system offers minimal breathing resistance and reduces worker fatigue, increasing productivity.

Low Air Pressure Requirement

Specifically designed for use with low-pressure air sources such as Bullard Free-Air® pumps, the respirator operates efficiently at air pressures between 1.5 and 20 psig (103-138 kPa), depending on hose length. FAMB2 respirators are also approved for use with high-pressure air sources, such as breathing air compressors.

More Protection

The FAMB2 respirator provides a higher degree of protection than negative-pressure air-purifying respirators. Because FAMB2 is an airline respirator, there is no need to maintain or buy expensive filter cartridges.

Wide Field of Vision

The low-profile facepiece allows a wide field of vision and easily accommodates workers wearing prescription or safety glasses. FAMB2 can be worn under faceshields, visors, and welding helmets.



FAMB2 Series Half-Mask Airline Respirator

FAMB2 Half-Mask Airline Respirator System

A complete FAMB2 Series Airline Respirator consists of the following three components:

1. Half-Mask
2. Breathing Tube Assembly with Flow Control Device
3. Breathing Air Supply Hose

All three Bullard components must be present and properly assembled to constitute a NIOSH approved respirator.

Approval No. TC-19C-469, Type C, Continuous Flow Class - F30 and F35

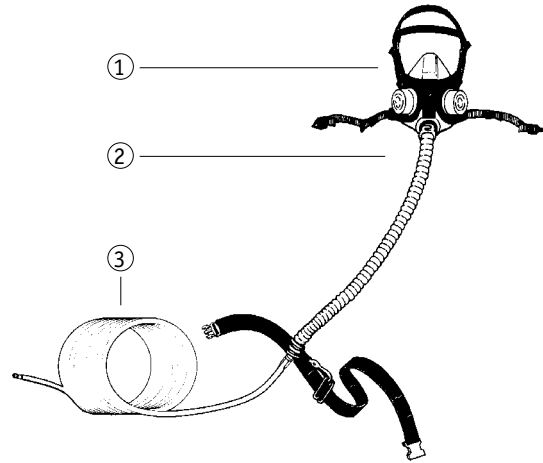

- FAMBSYS** FAMB2 Series Airline Respirator System
- FAMB235M respirator
 - EDP10 Free-Air® Pump
 - 100' air supply hose (V20100ST)



Half-Mask Respirator

- FAMB230S** Small Silicone Facepiece
FAMB230M Medium Silicone Facepiece
FAMB230L Large Silicone Facepiece
- Cradle suspension and breathing tube
 - 1/4" Industrial Interchange (Hansen compatible) flow control and belt
 - For use with compressed air



Half-Mask Respirator

- FAMB235S** Small Silicone Facepiece
FAMB235M Medium Silicone Facepiece
FAMB235L Large Silicone Facepiece
- Cradle suspension and breathing tube
 - 1/2" Industrial Interchange (Hansen compatible) flow control and belt
 - For use with Bullard Free-Air® Pumps



FAMB2 Half-Mask Airline Respirator

FAMB2 Series Half-Mask Respirator Components

- FAM2S** Small Half-Mask
- FAM2M** Medium Half-Mask
- FAM2L** Large Half-Mask
 - Silicone
 - Includes head straps



-
- FAM2CB** Cradle Headband Strap



-
- FAM2EVC2** Exhalation Valve Covers
 - 2 per package



-
- FAM2EVF10** Exhalation Valve
 - 10 per package





FAMB2 Half-Mask Airline Respirator

FAMB2 Series Half-Mask Fit Testing Accessories

FAMAK Fit Test Kit
 • Includes PortaCount® connector, sampling tube and (1) P100 filter



PMFC2 P100 Filter Cartridges (For fit test only)
 • 1 per package



FAMB Series Half-Mask Breathing Tube Assemblies

FAMB2T2C Breathing Tube Assembly
 • For use with FAMB235
 • Two nylon clamps (S18052)
 • 1/2" Industrial Interchange (Hansen compatible) quick-disconnect flow control
 • Nylon belt (4612)
 • For use with Bullard Free-Air® Pumps



FAMB2T3C Breathing Tube Assembly
 • For use with FAMB230
 • Two nylon clamps (S18052)
 • 1/4" Industrial Interchange (Hansen compatible) quick-disconnect flow control
 • Nylon belt (4612)
 • For use with compressed air



4612 Nylon Belt



36501 Vinyl Decon Belt



SparxLift Welding Helmet for Supplied Air Respirators

Integrated Protection

The SparxLift Welding Helmet, with a 1,000 Assigned Protection Factor (APF), is NIOSH-approved for use as a Supplied Air Respirator (SAR) system. Offering six flow control options, the SparxLift SAR system provides respiratory protection and ANSI/ISEA Z87.1+ high impact face protection in a single package for welders and grinders.

SparxLift is equipped with a clear panoramic polycarbonate lens to protect users while grinding and the engineered Nylon Shell provides tough, lightweight, heat resistant protection. The DuPont™ Nomex® shroud completes the protective envelope to cover the remainder of the face and head.

Innovative Design

Featuring an Auto Darkening Filter (ADF) and unique patented AutoLift design, SparxLift allows users to quickly switch from welding to grinding with the push of a button. SparxLift is equipped with optically correct Ultraviolet (UV) and Infrared (IR) filters to provide users with superior protection and viewing performance. The helmet's ADF reacts to prevent flash in 1/25,000 of a second and UV and IR filters provide full-time protection.

Intuitive Technology

Equipped with the patented Inner Sense™ feature, SparxLift detects the Radio Frequency (RF) signal produced by Tungsten Inert Gas (TIG) welders to darken the screen before the arc is struck. Innovative Z-slide ADF cartridge design with X-View filter allows for easy maintenance while providing a crisp, clean view from almost any angle.

Ice Cold Air Flow

Combine the SparxLift SAR system with Bullard's AC1000 Series Cool Tubes to battle heat stress while on the job. See Bullard's full line of Personal Climate Devices including cool tubes and hot/cold tubes on pages 201-206.



SparxLift Welding Helmet For Supplied Air

Technical Specifications			
Regulatory Standards	ANSI/ISEA Z87.1+ EN175 and EN379	Switching Delay (dark to light)	Low: 0.3 - 0.6s Fast: 0.1 - 0.35s
Helmet Weight (without shroud)	19.6 oz (560 grams)	Power Supply	3V Lithium (CR2032)
ADF Window Size	3.9" x 1.8" (97 x 46 mm)	Battery Life	~3,000 hours
Sensors	(2) Dual UV/IR	Supplementary Power	Solar Cells (Auto On/Off)
Switching Time	1/25,000 second (.04 msec)	Indicators	Low Battery
Shade Level	Inactivated Shade #4 Activated Shades #9-#13	Operating Temperature	23°F to 131°F (-5°C to 55°C)
Sensitivity Adjustment	Dual sensors plus pre-shading (low-high)	Storage Temperature	-4°F to 158°F (-20°C to 70°C)

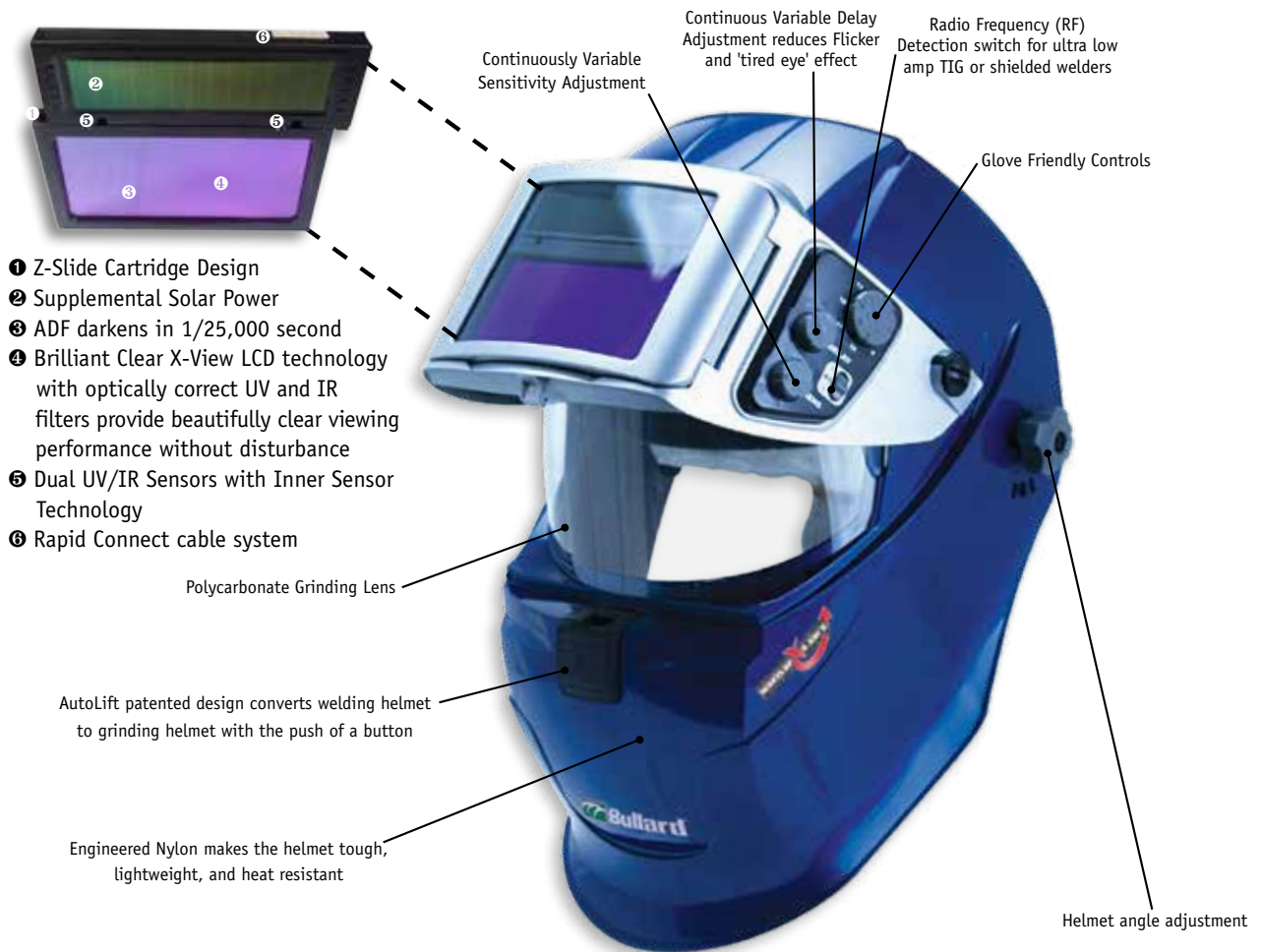

Supplied Air Respirator System (SAR)

Keep Cool When The Sparx Heat Up

AC1000 Series Cool Tubes

The AC1000 features an adjustable airflow control valve that allows the user to adjust the incoming air temperature to a level best suited to individual comfort.

- 30°F/-1°C of cooling
- Adjustable airflow control
- Durable metal construction

Dual-Cool Series

The DC50 Series Dual-Cool Tube assemblies work in conjunction with DC70 Series Vests to provide cooling to both the respirator head top and the wearer's torso.

Bullard is the only company to offer this type of NIOSH-approved apparatus.

- 30°F/-1°C of cooling
- Double-action cooling
- Cools respirator and vest
- Adjustable airflow control

Frigitron 2000 Series Cool Tubes

Designed for use with Bullard's ADP20, ICEPUMP11, and EDP30 ambient-air pumps, the Frigitron 2000 cools air by as much as 20°F maintaining worker comfort and maximizing productivity when working in hot, humid environments.

- 20°F/-7°C of cooling
- Use with Bullard Free-Air® Pumps
- Adjustable airflow control



Stay Warm In Cold Weather

HC2400 Series Hot/Cold Tubes

The HC2400 cools or warms incoming air from compressed breathing air sources.

- 30°F/-1°C of heating or cooling
- Adjustable airflow control
- Durable metal construction

Welding Helmet for Supplied Air Respirator

SparxLift Series Welding Helmet for SAR Selection Chart

1. SparxLift Helmet



• SLH

2. Choose Shroud



• SLS1 - Loose-Fitting
Facepiece Style 25 APF



• SLS2 - Hood
Style 1,000 APF

3. Choose Breathing Tube

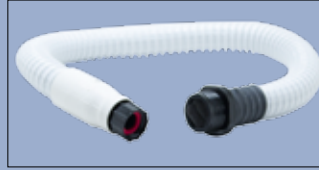

• SARHBT - SparxLift Breathing Tube for Supplied Air



• NMXBTC - Nomex Breathing Tube Cover

4. Choose Flow Control Device (includes nylon belt)



1/4" Constant Flow

- F30, F30B, F30S Industrial Interchange (Hansen Compatible)
- F31 - Schrader
- F32 - Snap-Tite Steel
- F33 - Snap-Tite Brass
- F34 - Snap-Tite Stainless
- F37 - CEJN
- F38 - Bayonet Steel

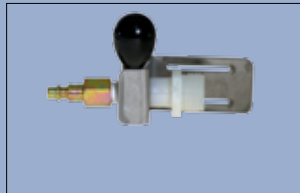

1/4" Adjustable Flow

- F40, F40B, F40S Industrial Interchange (Hansen Compatible)
- F41 - Schrader
- F42 - Snap-Tite Steel
- F43 - Snap-Tite Brass
- F44 - Snap-Tite Stainless
- F47 - CEJN
- F48 - Bayonet Steel



Cool Tubes for Compressed Air (Metal)

- AC100030, AC100030B, AC100030S 1/4" Industrial Interchange (Hansen Compatible)
- AC100031 - Schrader
- AC100032 - Snap-Tite Steel
- AC100033 - Snap-Tite Brass
- AC100034 - Snap-Tite Stainless
- AC100037 - CEJN
- AC100038 - Bayonet Steel

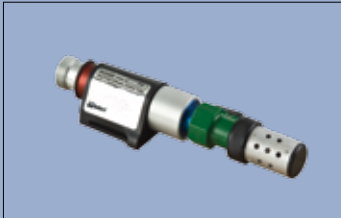

Hot/Cold Tubes for Compressed Air (Metal)

- HC240030, HC240030B, HC240030S
- 1/4" Industrial Interchange (Hansen Compatible)
- HC240031 - Schrader
- HC240032 - Snap-Tite Steel
- HC240033 - Snap-Tite Brass
- HC240034 - Snap-Tite Stainless
- HC240037 - CEJN
- HC240038 - Bayonet Steel



Cool Tubes for Free-Air® Pumps

- FRIGITRON2000 1/2" Industrial Interchange (Hansen Compatible)
- FRIGITRON2000B - Brass



• DC50 Series - Dual-Cool with DC70 Vests

*Above items are shown with Industrial Interchange Fittings. Snap-Tite, Schrader, CEJN and Bayonets are also available.

5. Choose Air Supply Hose



V10 Series
3/8" I.D. for Compressed Air

- 4696 25' Starter Hose
- 469650 50' Starter Hose
- 4696100 100' Starter Hose
- 5454 25' Extension Hose
- 5457 50' Extension Hose
- 5458 100' Extension Hose



V20 Series
1/2" I.D. for Free-Air® Pumps

- V2050ST 50' Starter Hose
- V20100ST 100' Starter Hose

SparxLift Series Airline Respirators

SparxLift Assemblies

A complete SparxLift Series Airline Respirator consists of the following four components:

- (1) Welding Respirator Helmet with Shroud
- (2) Breathing Tube with Optional Nomex® Cover
- (3) Flow Control Device
- (4) Breathing Air Supply Hose

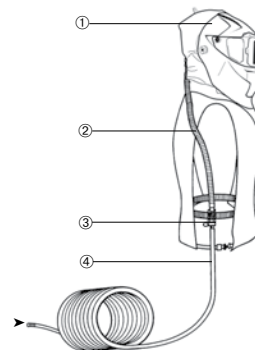

All four Bullard components must be present and properly assembled to constitute a NIOSH approved respirator.

Approval Numbers: TC-19C-0511 SLS1 Shroud-F30 Series Flow Control Devices, TC-19C-0512 SLS2 Shroud-F30 Series Flow Control Devices, TC-19C-0513 SLS1 Shroud-F40 Series Flow Control Devices, TC-19C-0514 SLS2 Shroud-F40 Series Flow Control Devices, TC-19C-0515 SLS1 Shroud-DC50 Series Flow Control Devices, TC-19C-0516 SLS2 Shroud-DC50 Series Flow Control Devices, TC-19C-0517 SLS1 Shroud- Frigitron 2000 Series Flow Control Devices, TC-19C-0518 SLS2 Shroud- Frigitron 2000 Series Flow Control Devices, TC-19C-0519 SLS1 Shroud- AC1000 Series Flow Control Devices, TC-19C-0520 SLS2 Shroud- AC1000 Series Flow Control Devices, TC-19C-0521 SLS1 Shroud- HC2400 Series Flow Control Devices, TC-19C-0522 SLS2 Shroud- HC2400 Series Flow Control Devices

The protective helmet meets ANSI/ISEA Standard Z87.1 Z87+ Eye & Face Protection.

SparxLift Series for a Supplied Air Respirator System (SAR)

Welding Helmet for use with Bullard Free-Air® Pumps

SLS135

Supplied Air Respirator Assembly for Welding

- SparxLift Welding Helmet (SLH)
- Shroud with 25 APF (SLS1)
- Breathing Tube (with NMxBTC Nomex® Breathing Tube Cover) (SARHBT)
- ½" Industrial Interchange (Hansen Compatible) continuous flow control
- Nylon Belt (4612)



SLS135

SLS235

Supplied Air Respirator Assembly for Welding

- SparxLift Welding Helmet (SLH)
- Shroud with 1000 APF (SLS2)
- Breathing Tube (with NMxBTC Nomex® Breathing Tube Cover) (SARHBT)
- ½" Industrial Interchange (Hansen Compatible) continuous flow control
- Nylon Belt (4612)



SLS235

SparxLift Series Airline Respirators

SparxLift Series Assemblies for a Supplied Air Respirator System (SAR)

Welding Helmet for use with Compressed Air

- SLS130** Supplied Air Respirator Assembly for Welding
- SparxLift Welding Helmet (SLH)
 - Shroud with 25 APF (SLS1)
 - Breathing Tube (with NMxBTC Nomex® Breathing Tube Cover) (SARHBT)
 - 1/4" Industrial Interchange (Hansen Compatible) continuous flow control
 - Nylon Belt (4612)
- SLS131** 1/4" Schrader continuous flow control
- SLS132** 1/4" Snap-Tite continuous flow control
- SLS133** 1/4" Snap-Tite Brass continuous flow control
- SLS134** 1/4" Snap-Tite Stainless Steel continuous flow control
- SLS137** 1/4" CEJN flow continuous flow control
- SLS138** 1/4" Bayonet (Hansen Compatible) continuous flow control



SLS130

- SLS230** Supplied Air Respirator Assembly for Welding
- SparxLift Welding Helmet (SLH)
 - Shroud with 1000 APF (SLS2)
 - Breathing Tube (with NMxBTC Nomex® Breathing Tube Cover) (SARHBT)
 - 1/4" Industrial Interchange (Hansen Compatible) continuous flow control
 - Nylon Belt (4612)
- SLS231** 1/4" Schrader continuous flow control
- SLS232** 1/4" Snap-Tite continuous flow control
- SLS233** 1/4" Snap-Tite Brass continuous flow control
- SLS234** 1/4" Snap-Tite Stainless Steel continuous flow control
- SLS237** 1/4" CEJN continuous flow control
- SLS238** 1/4" Bayonet continuous flow control



SLS230

- SLS140** Supplied Air Respirator Assembly for Welding
- SparxLift Welding Helmet (SLH)
 - Shroud with 25 APF (SLS1)
 - Breathing Tube (with NMxBTC Nomex® Breathing Tube Cover) (SARHBT)
 - 1/4" Industrial Interchange (Hansen Compatible) adjustable flow control
 - Nylon Belt (4612)
- SLS141** 1/4" Schrader adjustable flow control
- SLS142** 1/4" Snap-Tite adjustable flow control
- SLS143** 1/4" Snap-Tite Brass adjustable flow control
- SLS144** 1/4" Snap-Tite Stainless Steel adjustable flow control
- SLS147** 1/4" CEJN adjustable flow control
- SLS148** 1/4" Bayonet adjustable flow control



SLS140



SparxLift Series Airline Respirators

SparxLift Series Assemblies for a Supplied Air Respirator System (SAR)

Welding Helmet for use with Compressed Air

-
- SLS240** Supplied Air Respirator Assembly for Welding
- SparxLift Welding Helmet (SLH)
 - Shroud with 1000 APF (SLS2)
 - Breathing Tube (with NMxBTC Nomex® Breathing Tube Cover) (SARHBT)
 - 1/4" Industrial Interchange (Hansen Compatible) continuous flow control
 - Nylon Belt (4612)
- SLS241** 1/4" Schrader adjustable flow control
- SLS242** 1/4" Snap-Tite adjustable flow control
- SLS243** 1/4" Snap-Tite Brass adjustable flow control
- SLS244** 1/4" Snap-Tite Stainless Steel adjustable flow control
- SLS247** 1/4" CEJN adjustable flow control
- SLS248** 1/4" Bayonet adjustable flow control



SLS240

-
- SLS1AC100030** Supplied Air Respirator Assembly for Welding
- SparxLift Welding Helmet (SLH)
 - Shroud with 25 APF (SLS1)
 - Breathing Tube (with NMxBTC Nomex® Breathing Tube Cover) (SARHBT)
 - AC1000 Cool Tube with 1/4" Industrial Interchange (Hansen Compatible) fitting
 - Nylon Belt (4612)
- SLS1AC100031** AC1000 Cool Tube with 1/4" Schrader Nipple
- SLS1AC100032** AC1000 Cool Tube with 1/4" Snap-Tite Nipple
- SLS1AC100033** AC1000 Cool Tube with 1/4" Snap-Tite Brass Nipple
- SLS1AC100034** AC1000 Cool Tube with 1/4" Snap-Tite Stainless Steel Nipple
- SLS1AC100037** AC1000 Cool Tube with 1/4" CEJN Nipple
- SLS1AC100038** AC1000 Cool Tube with 1/4" Bayonet Nipple



SLS1AC100030

-
- SLS2AC100030** Supplied Air Respirator Assembly for Welding
- SparxLift Welding Helmet (SLH)
 - Shroud with 1000 APF (SLS2)
 - Breathing Tube with NMxBTC Nomex® Breathing Tube Cover (SARHBT)
 - AC1000 Cool Tube with 1/4" Industrial Interchange (Hansen Compatible) fitting
 - Nylon Belt (4612)
- SLS2AC100031** AC1000 Cool Tube with 1/4" Schrader Nipple
- SLS2AC100032** AC1000 Cool Tube with 1/4" Snap-Tite Nipple
- SLS2AC100033** AC1000 Cool Tube with 1/4" Snap-Tite Brass Nipple
- SLS2AC100034** AC1000 Cool Tube with 1/4" Snap-Tite Stainless Steel Nipple
- SLS2AC100037** AC1000 Cool Tube with 1/4" CEJN Nipple
- SLS2AC100038** AC1000 Cool Tube with 1/4" Bayonet Nipple



SLS2AC100030

SparxLift Series Airline Respirators

SparxLift Series Assemblies for a Supplied Air Respirator System (SAR)

Welding Helmet for use with Compressed Air

- SLS1HC240030** Supplied Air Respirator Assembly for Welding
- SparxLift Welding Helmet (SLH)
 - Shroud with 25 APF (SLS1)
 - Breathing Tube (with NMxBTC Nomex® Breathing Tube Cover) (SARHBT)
 - HC2400 Hot/Cold Tube with 1/4" Industrial Interchange (Hansen Compatible) fitting
 - Nylon Belt (4612)

- SLS1HC240031** HC2400 Hot/Cold Tube with 1/4" Schrader Nipple
SLS1HC240032 HC2400 Hot/Cold Tube with 1/4" Snap-Tite Nipple
SLS1HC240033 HC2400 Hot/Cold Tube with 1/4" Snap-Tite Brass Nipple
SLS1HC240034 HC2400 Hot/Cold Tube with 1/4" Snap-Tite Stainless Steel Nipple
SLS1HC240037 HC2400 Hot/Cold Tube with 1/4" CEJN Nipple
SLS1HC240038 HC2400 Hot/Cold Tube with 1/4" Bayonet Nipple



SLS1HC240030

- SLS2HC240030** Supplied Air Respirator Assembly for Welding
- SparxLift Welding Helmet (SLH)
 - Shroud with 1000 APF (SLS2)
 - Breathing Tube with NMxBTC Nomex® Breathing Tube Cover (SARHBT)
 - HC2400 Hot/Cold Tube with 1/4" Industrial Interchange (Hansen Compatible) fitting
 - Nylon Belt (4612)

- SLS2HC240031** HC2400 Hot/Cold Tube with 1/4" Schrader Nipple
SLS2HC240032 HC2400 Hot/Cold Tube with 1/4" Snap-Tite Nipple
SLS2HC240033 HC2400 Hot/Cold Tube with 1/4" Snap-Tite Brass Nipple
SLS2HC240034 HC2400 Hot/Cold Tube with 1/4" Snap-Tite Stainless Steel Nipple
SLS2HC240037 HC2400 Hot/Cold Tube with 1/4" CEJN Nipple
SLS2HC240038 HC2400 Hot/Cold Tube with 1/4" Bayonet Nipple



SLS2HC240030



SparxLift Series Airline Respirators

SparxLift Replacement Shroud

- SLS1** 25 APF Loose-Fitting Facepiece Style Shroud
SLS2 1,000 APH Hood Style Shroud



SLS1

SLS2

SparxLift Replacement Helmet

- SLH** SparxLift Helmet with ADF and ratchet headgear (no shroud)



SparxLift Replacement Helmet Parts

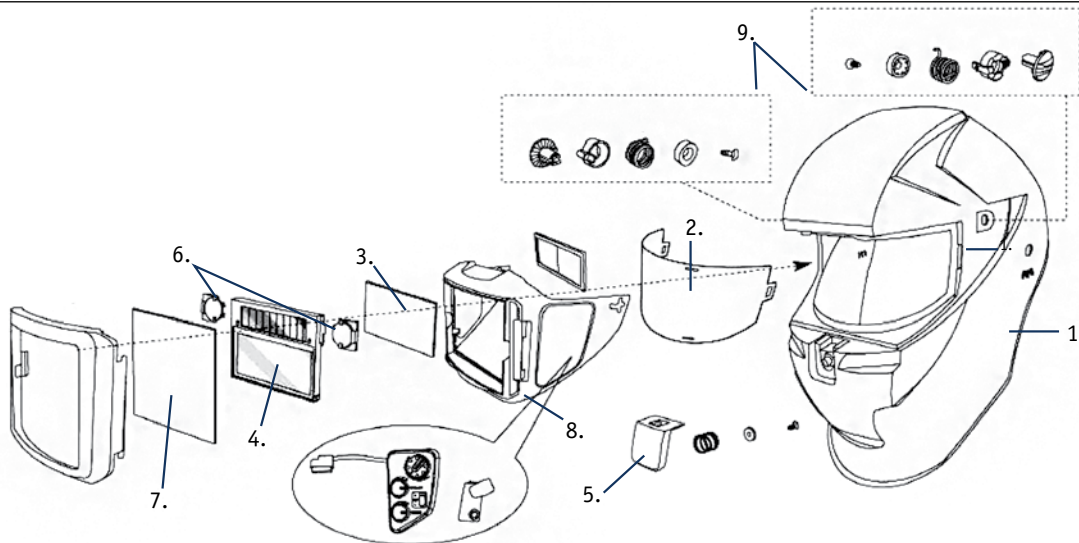

- 1. SLSHELLBLU** Helmet Shell, does not include harness or knob set
- 2. SLGL** Inner Protective Lens (Grinding), 3 pack
- 3. SLRCL** Inside Cover Plate, 5 pack
- 4. SLADF** Auto Darkening Filter
- 5. SLPBA** Push Button Assembly
- 6. SLBAT1** Battery
- 7. SLFCL** Front Cover Lens, 10 pack
- 8. SLALA** Auto Lift Assembly (Incl. external ADF controls, mounting kit, push button assembly)
- 9. SLHCA** Hinge Cap Assembly Kit

SparxLift Accessories (Not Pictured)

- SLCLP** Cover Lens Pack (5 outer, 2 inner lens)
SLHG Headgear (includes head band and knob set)
SLSBA Sweat Band Assembly

Breathing Air Supply Hose

Bullard offers a variety of hoses and fittings to deliver breathable air to the worker from a clean air source.

V5 Series

Coiled hose is ideal for working at varying distances from a fixed air outlet. It is easily stretched and retracts immediately when released. Its self-storage principle ensures that the hose is kept off the floor and out of the way of the operator, improving both safety and cleanliness.

V10 Series

Bullard V10 Series hose is intended for use with compressed air and has an inside diameter of $\frac{3}{8}$ ". Constructed of strong, yet flexible, EPDM rubber (ethylene propylene diene monomer (M-class) rubber) reinforced to prevent crushing or kinking, V10 Series hose is available in 25-, 50- and 100-foot sections configurable up to 300 feet in total length.

V20 Series

Bullard V20 Series hose is intended for use with Bullard Free-Air® Pumps and has an inside diameter of $\frac{1}{2}$ ". Constructed of strong yet flexible EPDM rubber (ethylene propylene diene monomer (M-class) rubber) reinforced to prevent crushing or kinking, V20 Series hose is available in 50- and 100 foot sections configurable up to 300 feet in total length.

Fittings

Bullard offers five different types of fittings to ensure breathing air supply fittings are incompatible with fittings for non-breathing air gases such as nitrogen, natural gas, and argon. These fittings include:

- Industrial Interchange (Hansen Compatible)
- Schrader
- Snap-Tite
- CEJN
- Bayonet

Breathing Air Supply Hose

V5 Coiled Hose for Compressed Air

25-Foot Lengths

- V5KF2530XXX** V5 Industrial Interchange Hose, Kink-Free
- 1/4" Industrial Interchange (Hansen compatible) quick-disconnect coupler and nipple
 - For use with compressed air only. Not for use with Bullard Free-Air® pumps



Note: XXX denotes color. Red = RED; Blue = BLU; Black = BLK; Yellow = YLW

- V5KF2531XXX** V5 Schrader Hose, Kink-Free
- 1/4" Schrader quick-disconnect coupler and nipple
 - For use with compressed air only. Not for use with Bullard Free-Air® pumps



Note: XXX denotes color. Red = RED; Blue = BLU; Black = BLK; Yellow = YLW

- V5KF2532XXX** V5 Snap-Tite Hose, Kink-Free
- 1/4" Snap-Tite steel quick-disconnect coupler and nipple
 - For use with compressed air only. Not for use with Bullard Free-Air® pumps



Note: XXX denotes color. Red = RED; Blue = BLU; Black = BLK; Yellow = YLW

- V5KF2533XXX** V5 Snap-Tite (Brass) Hose, Kink-Free
- 1/4" Snap-Tite brass quick-disconnect coupler and nipple
 - For use with compressed air only. Not for use with Bullard Free-Air® pumps



Note: XXX denotes color. Red = RED; Blue = BLU; Black = BLK; Yellow = YLW

50-Foot Lengths

- V5KF5030XXX** V5 Industrial Interchange Hose, Kink-Free
- 1/4" Industrial Interchange (Hansen compatible) quick-disconnect coupler and nipple
 - For use with compressed air only. Not for use with Bullard Free-Air® pumps



Note: XXX denotes color. Red = RED; Blue = BLU; Black = BLK; Yellow = YLW

- V5KF5031XXX** V5 Schrader Hose, Kink-Free
- 1/4" Schrader quick-disconnect coupler and nipple
 - For use with compressed air only. Not for use with Bullard Free-Air® pumps



Note: XXX denotes color. Red = RED; Blue = BLU; Black = BLK; Yellow = YLW

- V5KF5032XXX** V5 Snap-Tite Hose, Kink-Free
- 1/4" Snap-Tite (Steel) quick-disconnect coupler and nipple
 - For use with compressed air only. Not for use with Bullard Free-Air® pumps



Note: XXX denotes color. Red = RED; Blue = BLU; Black = BLK; Yellow = YLW

- V5KF5033XXX** V5 Snap-Tite Hose, Kink-Free
- 1/4" Snap-Tite (Brass) quick-disconnect coupler and nipple
 - For use with compressed air only. Not for use with Bullard Free-Air® pumps



Note: XXX denotes color. Red = RED; Blue = BLU; Black = BLK; Yellow = YLW

Breathing Air Supply Hose

V10 3/8" ID Heavy Duty Air Supply Hose for Compressed Air

*Not for use with Bullard Free-Air® pumps



Starter Hoses (Includes nipple on one end and coupler on the other)

25-Foot Lengths

- 4696** V1025ST Industrial Interchange Hose Kit (Black)
- 3/4" Industrial Interchange (Hansen Compatible) quick-disconnect coupler
 - V13 hose-to-pipe adapter fitting (3/8" hose to 3/8" pipe)
 - For use with compressed air only. Not for use with Bullard Free-Air® pumps
 - V17 male nipple included



- 46913** V1025ST Schrader Hose Kit (Black)
- 3/4" Schrader quick-disconnect coupler
 - V13 hose-to-pipe adapter fitting (3/8" hose to 3/8" pipe)
 - For use with compressed air only. Not for use with Bullard Free-Air® pumps



- 46915** V1025ST Snap-Tite Hose Kit (Black)
- 46916** V1025ST Snap-Tite Hose Kit (Green)
- 3/4" Snap-Tite quick-disconnect coupler
 - V13 hose-to-pipe adapter fitting (3/8" hose to 3/8" pipe)
 - For use with compressed air only. Not for use with Bullard Free-Air® pumps



- 46918** V1025ST Snap-Tite Hose Kit (Blue)
- Same as above
 - Includes Nipple (S19442)

46918

50-Foot Lengths

- 46917** V1050ST Snap-Tite Hose Kit (Green)
- 469650** V1050ST Industrial Interchange Hose Kit (Black) - includes V17 nipple
- 46919** V1050ST Snap-Tite Hose Kit (Blue)
- 3/4" quick-disconnect coupler
 - V13 hose-to-pipe adapter fitting (3/8" hose to 3/8" pipe)
 - For use with compressed air only. Not for use with Bullard Free-Air® pumps



46917

100-Foot Lengths

- 4696100** V10100ST Industrial Interchange Hose Kit (Black) - includes V17 nipple
- 3/4" Industrial Interchange quick-disconnect coupler and male Flow control
 - V13 hose-to-pipe adapter fitting (3/8" hose to 3/8" pipe)
 - For use with compressed air only. Not for use with Bullard Free-Air® pumps



Breathing Air Supply Hose

Breathing Air Supply Hose

Extension Hoses

25-Foot Lengths

- 5454** V1025 extension Hose Kit (Black)
- 54510** V1025 extension Hose Kit (Green)
- 54514** V1025 extension hose kit (Blue)
 - V11 hose-to-hose adapter fitting
 - V13 hose-to-pipe adapter fitting ($\frac{3}{8}$ " hose to $\frac{3}{8}$ " pipe)
 - For use with compressed air only. Not for use with Bullard Free-Air® pumps



5454

50-Foot Lengths

- 5457** V1050 extension Hose Kit (Black)
- 54511** V1050 extension Hose Kit (Green)
- 54513** V1050 extension Hose Kit (Blue)
 - V11 hose-to-hose adapter fitting
 - V13 hose-to-pipe adapter fitting ($\frac{3}{8}$ " hose to $\frac{3}{8}$ " pipe)
 - For use with compressed air only. Not for use with Bullard Free-Air® pumps



54511

100-Foot Lengths

- 5458** V10100 extension Hose Kit (Black)
- 54512** V10100 extension Hose Kit (Blue)
 - V11 hose-to-hose adapter fitting
 - V13 hose-to-pipe adapter fitting ($\frac{3}{8}$ " hose to $\frac{3}{8}$ " pipe)
 - For use with compressed air only. Not for use with Bullard Free-Air® pumps



54512

V20 1/2" ID Hose for Free-Air® Pumps

- V2050ST** V20 Industrial Interchange Hose (Black)
 - 50 feet of hose
 - $\frac{1}{2}$ " Industrial Interchange (Hansen compatible) quick-disconnect coupler and nipple
 - For use with Bullard Free-Air® pumps



- V20100ST** V20 Industrial Interchange Hose (Black)
 - 100 feet of hose
 - $\frac{1}{2}$ " Industrial Interchange (Hansen compatible) quick-disconnect coupler and nipple
 - For use with Bullard Free-Air® pumps



Hose Adapters

- V11** $\frac{3}{8}$ " Hose to $\frac{3}{8}$ " Hose Adapter, Brass



- V12** $\frac{3}{8}$ " Hose to $\frac{1}{4}$ " Pipe Adapter, Brass



- V13** $\frac{3}{8}$ " Hose to $\frac{3}{8}$ " Pipe Adapter, Brass



Supplied Air Fitting Guide

The couplings pictured below are the most popular styles used on airline respirators. A coupling, which is made up of a socket and a plug, is also called a "QD" or "fitting" and comes in various socket (female) and plug (male) sizes. Couplings can have male, female, or hose barb ends for different types of connections.

Industrial Interchange/Hansen-Compatible

Snap-Tite - Also known as Foster; "short and stubby"

Schrader - Looks like a bullet; turn the sleeve to release

CEJN - Similar to Hansen; two hands must be used to disconnect

Bayonet - Long and skinny with pins on the side; no ball bearings to trap grit. Favorite of abrasive blasters

Dynaswivel® - Swivels in two axes to keep from kinking

Quick-Disconnect Nipples

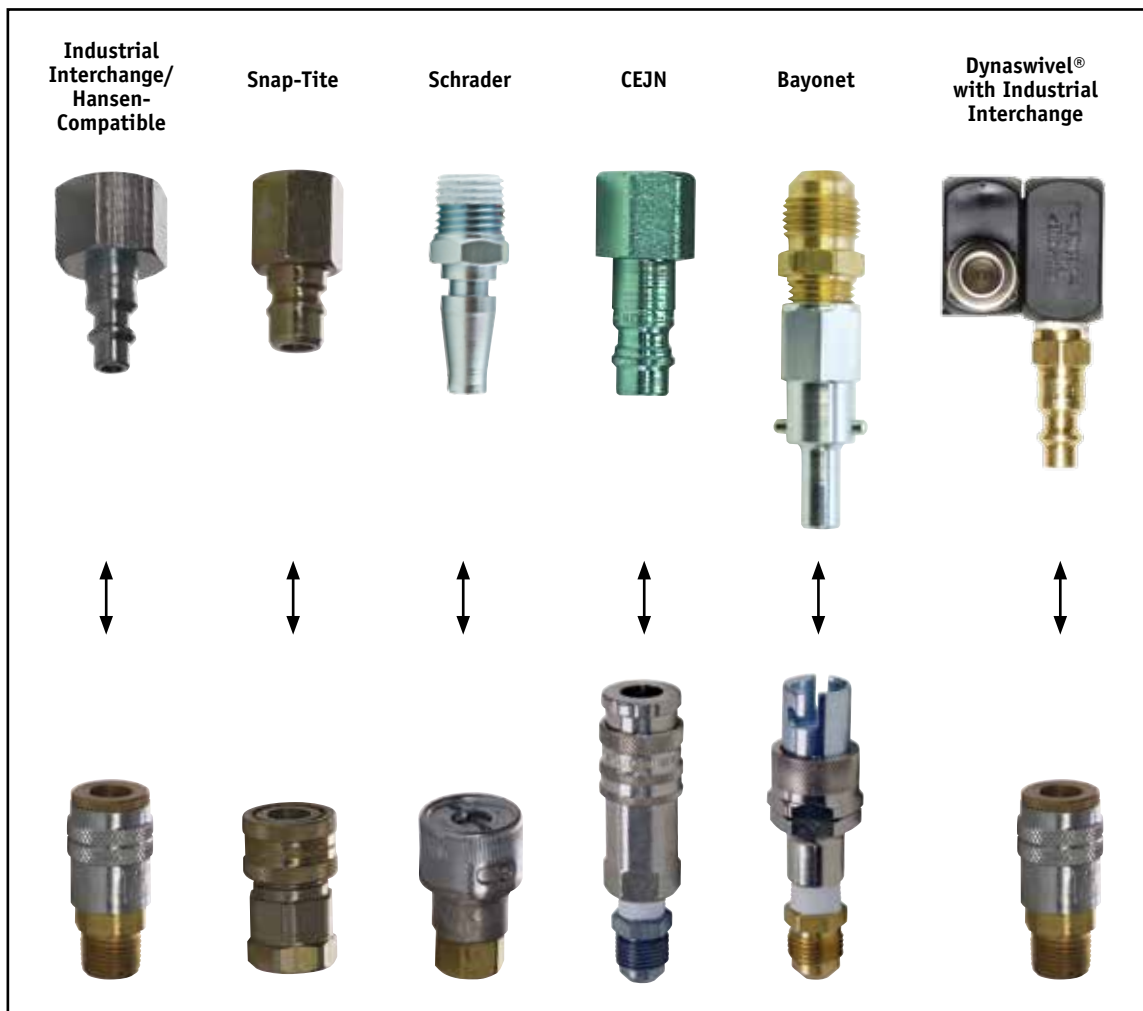

Quick-Disconnect Couplers

Breathing Air Supply Hose

Breathing Air Supply Hose - Quick-Disconnect Couplers

- V14** Industrial Interchange Female Coupler
- 1/4" Industrial Interchange (Hansen compatible) quick-disconnect coupler
 - Includes shut-off with 1/4" female pipe thread, National Pipe Thread (NPT)
 - V12 hose to pipe adapter required to connect to V10 extension hose



- V15** Industrial Interchange Female Coupler
- 1/4" Industrial Interchange (Hansen compatible) quick-disconnect coupler
 - Includes shut-off with 3/8" male pipe thread, National Pipe Thread (NPT)



- V18** Schrader Female Coupler
- 1/4" Schrader quick-disconnect coupler
 - Includes shut-off with 1/4" female pipe thread, National Pipe Thread (NPT)
 - V12 hose to pipe adapter required to connect to V10 extension hose



- V19** Snap-Tite Female Coupler, Steel
- V19B** Snap-Tite Female Coupler, Brass
- 1/4" Snap-Tite quick-disconnect coupler
 - Includes shut-off with 1/4" female pipe thread, National Pipe Thread (NPT)
 - V12 hose to pipe adapter required to connect to V10 extension hose



- V27** Industrial Interchange Coupler
- 1/4" Industrial Interchange coupler assembly
 - Includes V12 hose to pipe adapter



- 3914** CEJN Coupler
- 1/4" CEJN quick-disconnect coupler
 - Includes shut-off with 1/4" female pipe thread, National Pipe Thread (NPT)
 - Includes special orifice adapter which connects respirator to the airline extension hose. Use only with orifice adapter
 - Includes V12 hose to pipe adapter











- 3421** Bayonet Coupler
- 1/4" Bayonet quick-disconnect coupler
 - Includes shut-off with 1/4" female pipe thread, National Pipe Thread (NPT)
 - Includes V12 hose to pipe adapter



Breathing Air Supply Hose

Breathing Air Supply Hose - Quick-Disconnect Nipples

V17	Industrial Interchange Flow control <ul style="list-style-type: none">• 1/4" Industrial Interchange (Hansen compatible) steel male quick-disconnect nipple with 3/8" female pipe thread, National Pipe Thread (NPT)• Requires V13 hose adapter to connect to Bullard V10 air supply hose	
S19432	Schrader Flow control <ul style="list-style-type: none">• 1/4" Schrader steel male quick-disconnect nipple with 1/4" female pipe thread, National Pipe Thread (NPT)• Requires V12 hose adapter to connect to Bullard V10 air supply hose	
S19433	Schrader Flow control <ul style="list-style-type: none">• 1/4" Schrader steel male quick-disconnect nipple with 1/4" male pipe thread	
S19442	Snap-Tite Steel Flow control <ul style="list-style-type: none">• 1/4" Snap-Tite steel male quick-disconnect nipple with 1/4" female pipe thread, National Pipe Thread (NPT)• Requires V12 hose adapter to connect to Bullard V10 air supply hose	
S19443	Snap-Tite Brass Flow control <ul style="list-style-type: none">• 1/4" Snap-Tite brass male quick-disconnect nipple with 1/4" female pipe thread, National Pipe Thread (NPT)• Requires V12 hose adapter to connect to Bullard V10 air supply hose	
3902	CEJN Flow control <ul style="list-style-type: none">• 1/4" CEJN steel male quick-disconnect nipple with 1/4" female pipe thread, National Pipe Thread (NPT)• Requires V12 hose adapter to connect to Bullard V10 air supply hose	
3420	Bayonet Flow control <ul style="list-style-type: none">• 1/4" Bayonet steel male quick-disconnect nipple with 1/4" female pipe thread, National Pipe Thread (NPT)• Includes V12 hose to pipe adapter to connect to Bullard V10 air supply hose	
3422	Bayonet Flow control <ul style="list-style-type: none">• 1/4" Bayonet steel male quick-disconnect nipple with 1/4" male pipe thread, National Pipe Thread (NPT)• Includes V12 hose to pipe adapter to connect to Bullard V10 air supply hose	



Personal Climate Devices

Bullard climate control devices help increase worker comfort and productivity.

Bullard offers the largest number of personal devices for use with airline respirators. Each system enables a worker to adjust and control the temperature of air delivered to the respirator. On extremely hot summer days, air exiting a typical breathing air compressor can exceed 300°F (150°C). Air exiting an ambient air pump can exceed 200°F (100°C). Even with properly installed after coolers and in-line filters, the air entering a respirator could exceed ambient temperatures.

If workers breathe excessively warm air for prolonged periods of time, they may experience discomfort, fatigue, and possibly dehydration. During winter months, excessively cold air can have similar effects. Eventually, all of these conditions may reduce worker productivity. Bullard's personal climate devices help correct these uncomfortable working conditions for wearers of Bullard airline respirators.

Cool Tubes

The Bullard line of cool tubes are designed to cool incoming air from compressed breathing air sources by as much as 20°- 40°F (11°- 22°C) and feature adjustable airflow control valves that allow the user to adjust the incoming air temperature to a level best suited to individual comfort.

Hot/Cold Tubes

The Bullard Hot/Cold Tubes cool or warm incoming air from compressed breathing air sources. When used in the cool mode, the Hot/Cold Tube decreases the incoming air temperature by as much as 40°F (22°C). When warm air is desired, the incoming air temperature may be increased by up to 30°F (17°C).

DC50 Series Dual-Cool

The Dual-Cool Series provides superior cooling to Bullard respirators, while also sending cool air to the vest for upper torso cooling. The Dual-Cool will cool incoming air from compressed breathing sources by as much as 30°F (17°C). Separate control knobs allow the worker to adjust the temperature of air to each zone.

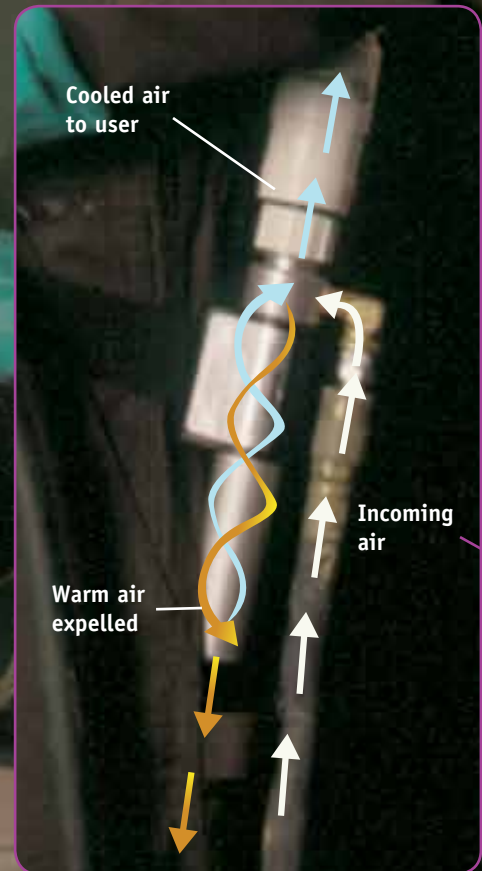
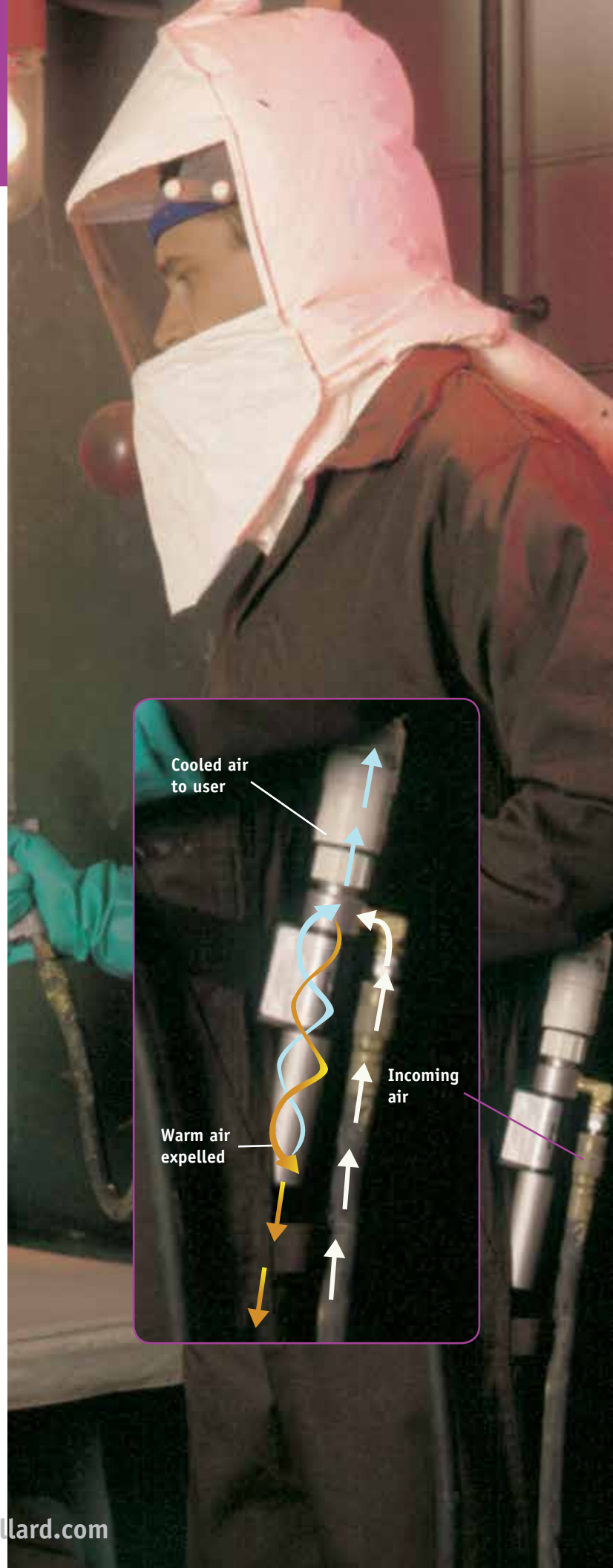

Personal Climate Devices

	Climate Control Devices						
		CT	AC1000	HCT	HC2400	Frigitron 2000	DC50 Dual-Cool
Respirator	GenVX®	X	X	X	X	X	X
	88VX	X	X	X	X	X	X
	20LF		X		X	X	X
	CC20		X		X	X	X
	RT		X		X	X	X
	GR50		X		X	X	X
	Spectrum Series®	X	X	X	X		
	FAMB						
	SparxLift		X		X	X	X
Fitting Type	Hansen/Industrial Interchange	X	X	X	X	X	X
	Schrader	X	X	X	X		X
	Snap-Tite	X	X	X	X		X
	CEJN	X	X	X	X		X
	Dynaswivel®	X		X			
Air Source	Breathing Air Compressor	X	X	X	X	X	X
	Free-Air® Pump					X	
	ICE Pump		*With Spectrum Series® - Continuous Flow Only			X	

Go to www.BuildYourBullard.com to configure entire system

Cubic Feet per Minute (cfm) Requirements								
Respirator Type	Flow Control Type	Minimum cfm	Respirator Type	Flow Control Type	Minimum cfm	Respirator Type	Flow Control Type	Min. CFM
FAMB	All	4	GR50	F30 Series	6	SparxLift	F30 Series	6
Spectrum Series®	All	4	GR50	F40 Series	6	SparxLift	F40 Series	6
20LF	F30 Series	6	GR50	AC1000 Series	15	SparxLift	AC1000 Series	15
20LF	F40 Series	6	GR50	HC2400 Series	15	SparxLift	HC2400 Series	15
20LF	AC1000 Series	15	GR50	DC50 Series	20	SparxLift	DC50 Series	20
20LF	HC2400 Series	15	GR50	Frigitron 2000	15	SparxLift	Frigitron 2000	15
20LF	DC50 Series	20	88VX	F30 Series	6			
20LF	Frigitron 2000	15	88VX	F40 Series	6			
CC20	F30 Series	6	88VX	AC1000 Series	15			
CC20	F40 Series	6	88VX	HC2400 Series	15			
CC20	AC1000 Series	15	88VX	CT Series	15			
CC20	HC2400 Series	15	88VX	HCT Series	15			
CC20	DC50 Series	20	88VX	DC50 Series	20			
CC20	Frigitron 2000	15	88VX	Frigitron 2000	15			
RT	F30 Series	6	GenVX®	F30 Series	6			
RT	F40 Series	6	GenVX®	F40 Series	6			
RT	AC1000 Series	15	GenVX®	AC1000 Series	15			
RT	HC2400 Series	15	GenVX®	HC2400 Series	15			
RT	DC50 Series	20	GenVX®	CT Series	15			
RT	Frigitron 2000	15	GenVX®	HCT Series	15			
			GenVX®	DC50 Series	20			
			GenVX®	Frigitron 2000	15			

Personal Climate Devices

Cool Tubes

- AC1000 Series**
- Metal Construction
 - Includes 1/4" male nipple and leather heat shield

- AC100030** Industrial Interchange (Hansen Compatible)
AC100031 Schrader
AC100032 Snap-Tite
AC100033 Snap-Tite Brass
AC100037 CEJN
AC100038 Bayonet



AC100030

- CT Series**
- Engineered Polymer Construction
 - Exhaust Filter protects against paint overspray
 - Directs hot air away from the body
 - Includes 1/4" male nipple, nylon belt, and leather heat shield

- CT30** Industrial Interchange (Hansen Compatible)
CT30B Industrial Interchange - Brass (Hansen Compatible)
CT30S Industrial Interchange - Stainless (Hansen Compatible)
CT30SW Industrial Interchange - Dynaswivel® (Hansen Compatible)
CT30BSW Industrial Interchange - Dynaswivel® Brass (Hansen Compatible)
CT30SSW Industrial Interchange - Dynaswivel® Stainless (Hansen Compatible)
CT31 Schrader
CT32 Snap-Tite
CT33 Snap-Tite Brass
CT37 CEJN
CT38 Bayonet



CT30

- FRIGITRON2000 Series**
- For use with Free-Air® Pumps
 - Includes 1/2" male nipple and nylon belt

- FRIGITRON2000** Industrial Interchange (Hansen Compatible)
FRIGITRON2000B Industrial Interchange, Brass (Hansen Compatible)



FRIGITRON2000

Replacement Parts

- V1000** 1/4" Industrial Interchange nipple (Hansen Compatible) for climate devices
272556 1/2" Industrial Interchange nipple (Hansen Compatible) and adapter for FRIGITRON2000



V1000

- 30SW** Dynaswivel® with 1/4" Industrial Interchange nipple (Hansen Compatible) for CT30SW and HCT30SW
30BSW Dynaswivel® Brass with 1/4" Industrial Interchange nipple (Hansen Compatible) for CT30SW and HCT30SW
30SSW Dynaswivel® Stainless with 1/4" Industrial Interchange nipple (Hansen Compatible) for CT30SW and HCT30SW

- HS** Leather Heat Shield
CTF Cool Tube Filter - Package of 10



HS

- CTCAP** End Cap Replacement



4612

- 4612** Nylon Belt



36501

- 36501** Vinyl Decon Belt

Personal Climate Devices

Hot/Cold Tubes

- HC2400 Series**
- For use with Compressed Air
 - Metal Construction
 - Includes 1/4" male nipple, nylon belt, and leather heat shield

- HC240030** Industrial Interchange (Hansen Compatible)
HC240031 Schrader
HC240032 Snap-Tite
HC240033 Snap-Tite Brass
HC240037 CEJN
HC240038 Bayonet



HC240030

- HCT Series**
- For use with Compressed Air
 - Engineered Polymer Construction
 - Exhaust Filter protects against paint overspray
 - Directs hot air away from the body
 - For use with 88VX and GenVX® Series Bullard Respirators
 - Includes 1/4" male nipple, nylon belt, and leather heat shield

- HCT30** Industrial Interchange (Hansen Compatible)
HCT30B Industrial Interchange Brass (Hansen Compatible)
HCT30S Industrial Interchange - Stainless (Hansen Compatible)
HCT30SW Industrial Interchange - Dynaswivel® (Hansen Compatible)
HCT30BSW Industrial Interchange - Dynaswivel® Brass (Hansen Compatible)
HCT30SSW Industrial Interchange - Dynaswivel® Stainless (Hansen Compatible)
HCT31 Schrader
HCT32 Snap-Tite
HCT33 Snap-Tite Brass
HCT37 CEJN
HCT38 Bayonet



HCT30

Replacement Parts

- V1000** 1/4" Industrial Interchange nipple (Hansen Compatible) for climate devices
- MV2400** Muffler valve assembly
- 30SW** Dynaswivel® with 1/4" Industrial Interchange nipple (Hansen Compatible) for CT30SW and HCT30SW
- 30BSW** Dynaswivel® Brass with 1/4" Industrial Interchange nipple (Hansen Compatible) for CT30SW and HCT30SW
- 30SSW** Dynaswivel® Stainless with 1/4" Industrial Interchange nipple (Hansen Compatible) for CT30SW and HCT30SW



V1000

- HS** Leather Heat Shield



HS

- HCTCVKIT** Valve Assembly for HCT Series

- HCTK** Filter Cap for HCT Series



4612

- 4612** Nylon Belt



- 36501** Vinyl Decon Belt

36501



Personal Climate Devices

Dual-Cool Tubes for use with Vests (purchased separately) and Respirator

- DC5040 Series**
- Metal Construction
 - Includes 1/4" male nipple, nylon belt, and leather heat shield

- DC5040** Industrial Interchange (Hansen Compatible)
DC5041 Schrader
DC5042 Snap-Tite
DC5043 Snap-Tite Brass
DC5047 CEJN
DC5048 Bayonet

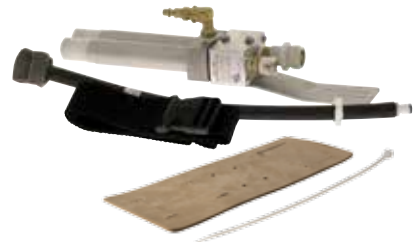

DC5040

Replacement Parts

- V1000** 1/4" Industrial Interchange (Hansen Compatible) nipple for cooling device



V1000

- DCHS** Leather Heat Shield



DCHS

- CH60** Connector Hose



CH60

- S18052** Clamp



S18052

Air-Fed Cool Vest

- DC 70 Series**
- For use with DC5040, AC1000DC, or CT30DC Personal Cooling Devices
 - May be worn without a respirator when used with AC1000DC or CT30DC Personal Cooling Device
 - Nylon Outer Shell
 - Breathable Cotton Inner Shell

- DC70ML** Medium/Large, 49" Chest
DC70XLXXL Extra Large / 2XL, 53.5" Chest
DC705X 5XL, 66" Chest



Cool Tubes for use with Air-Fed Vest without respirator

- AC1000DC**
- Includes 1/4" male nipple
 - Nylon belt (4612)
 - Leather heat shield (HS)
 - Connector Hose (CH1000)



AC1000DC

- CT30DC**
- Includes 1/4" male nipple
 - Nylon belt (4612)
 - Leather heat shield (HS)
 - Connector Hose (CH1000)



CT30DC

Personal Climate Devices

Air Fed Cool Vest Replacement Parts

CH1000 Connector hose with clamp



V1000 1/4" Industrial Interchange (Hansen Compatible) nipple for cooling devices



HS Leather Heat Shield



4612 Nylon Belt



36501 Vinyl Decon Belt



Air Quality and Filtration

41 Series Airline Filters

41 Series Airline Filters help deliver cleaner air for up to six workers.

Versatile Application

OSHA (Occupational Safety & Health Administrators) requires that employers provide their workers with Grade D breathing air. Bullard Airline Filters can be used in conjunction with other compressor safeguards, such as carbon monoxide (CO) monitoring, to help supply Grade D breathing air to supplied air respirators. They may also be used to supply drier, cleaner air to tools and pneumatic systems to reduce down-time and repair costs.

Heavy Duty

The 41 Series Airline Filters are constructed of heavy-gauge steel to withstand rugged industrial environments.

High Capacity

41 Series Airline Filters contain large, disposable filter cartridges, allowing for longer periods of filtration.

Lightweight for Easy Portability

Each model weighs approximately 23 pounds (10.5 kg).

Efficient

The 41 Series Filter cartridges are specifically designed to effectively trap and remove oil particulates, odor, and organic vapors using a multi-layer filtering system. Compressor-supplied air enters the filter and travels through six layers of filter material before exiting through the outlet port. Carded cotton, felt material, activated charcoal, and activated alumina work in sequence to supply cleaner air to workers or equipment.

Replaceable filter cartridge (7-stage operation)

Cartridges effectively trap and remove impurities with little pressure loss. The supplied air enters the compressor at inlet connector (A), travels through six layers of filter material, and exits outlet connector (B). Filter materials work in sequence to trap and hold water, oil, particulates, odors, and organic vapors, so that cleaner air is delivered to workers or equipment.

1. Water is removed by condensation against the cylinder wall
2. Carded cotton removes particulates
3. Activated alumina adsorbs oil and moisture
4. Activated charcoal removes odors and moisture
5. Felt material removes particulates
6. Carded cotton removes particulates
7. Respiratory felt at final stage acts as a final filter before air is transferred to worker or air driven tools

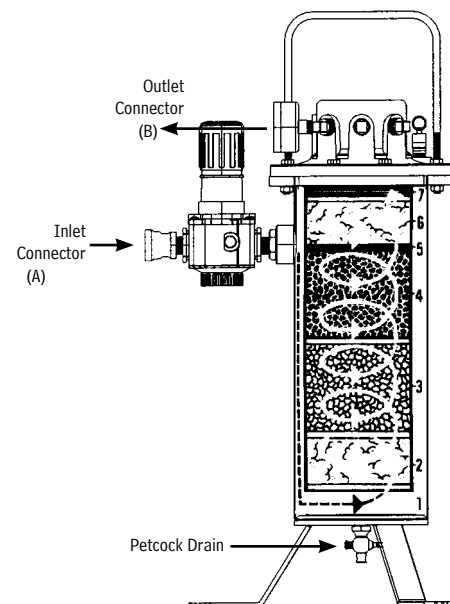

41 Series Airline Filters

Specifications						
Airline Filter	Model 41A	Model 41P2	Model 41PWM	Model 41P6	Model 41P6WM	Model 41P2E
Max. Air Flow Rate	100 cfm* (2830 lpm)	75 cfm (2120 lpm)	75 cfm (2120 lpm)	75 cfm (2120 lpm)	75 cfm (2120 lpm)	75 cfm (2120 lpm)
Inlet Connection	1" NPT (Fem.)	1" NPT (Fem.)	1" NPT (Fem.)	1" NPT (Fem.)	1" NPT (Fem.)	3/4" (19 mm) NPT (Fem.)
Outlet Connection	1" NPT (Fem.)	2 outlets 3/8" NPT (Fem.)	2 outlets 3/8" NPT (Fem.)	6 outlets 3/8" NPT (Fem.)	6 outlets 3/8" NPT (Fem.)	2 outlets 1/4" (6 mm) BPT (Fem.)
Relief Valve	-	125 psig (8.6 bar)	125 psig (8.6 bar)	125 psig (8.6 bar)	125 psig (8.6 bar)	125 psig (8.6 bar)
Tank Diameter	5 1/2" (14 cm)	5 1/2" (14 cm)	5 1/2" (14 cm)	5 1/2" (14 cm)	5 1/2" (14 cm)	5 1/2" (14 cm)
Height	19" (48 cm)	23 1/2" (60 cm)	23" (58 cm)	25 1/4" (64 cm)	22" (56 cm)	23 1/2" (60 cm)
Weight	19 lb. (8.6 kg)	22 lb. (10 kg)	27 lb. (12.2 kg)	24 lb. (10.9 kg)	28 lb. (12.7 kg)	22 lb. (10 kg)

*At maximum recommended pressure of 100 psig (6.9 bar)

41 Series Portable Filtration and Carbon Monoxide (CO) Monitoring One-or-Two Worker Systems

All assemblies include Heavy Duty 41 Series Filter with 7-stage filtration, CO monitor with auto calibration, audible and visual alarms for high CO and low battery, and 6-foot 110 VAC power cord.

10 PPM PART NUMBER	5 PPM PART NUMBER	
COHP41P2	C05HP41P2	75 cfm, Two-Outlet Unit
COHP41P2CABCK Calibration Kit Included	C05HP41P2CABCK Calibration Kit Included	75 cfm, Two-Outlet Unit
COHP41P2WMCABCK Calibration Kit Included	C05HP41P2WMCABCK Calibration Kit Included	75, cfm Two-Outlet Unit



COHP41P2

Bundles

COHP41P2CC20	Includes CC20 Respirator (CC20TIC30RT)
COHP41P288VX	Includes 88VX Respirator (88VX3230)

One-to Six-Worker Systems

All assemblies include Heavy Duty 41 Series Filter with 7-stage filtration, CO monitor with auto calibration, audible and visual alarms for high CO and low battery, and 6-foot 110 VAC power cord.

10 PPM PART NUMBER	5 PPM PART NUMBER	
COHP41P6	C05HP41P6	75 cfm, Six-Outlet Unit

Breathing Air Filtration

41 Series Filter Assemblies

41A

Single Outlet

- 1" NPT inlet, 1" NPT outlet
- Includes 41AF filter cartridge
- Does not include regulator, pressure gauge, or relief valve
- Handle (41HK) must be ordered separately
- Shipping weight: 22 lbs.



 **41P2**

2-Outlet

- 1" NPT inlet, 1/4" and 3/8" NPT (female) outlets
- Includes 41AF filter cartridge
- Regulator adjustable between 0-100 psig
- Relief valve set at 125 psig
- Pressure gauge
- Handle (41HK) must be ordered separately
- Shipping weight: 27 lbs.



41P2WM

2-Outlet Wall Mount

Same as Model 41P6 with:

- Galvanized steel wall mount bracket (no legs)
- Shipping weight: 31 lbs.



41P6

6-Outlet

- 1" NPT inlet, 3/8" NPT (female) outlets
- Includes 41AF filter cartridge
- Regulator adjustable between 0-100 psig
- Relief valve set at 125 psig
- Pressure gauge
- Shipping weight: 27 lbs.
- Handle (41HK) must be ordered separately



41P6WM

6-Outlet, Wall Mount

Same as Model 41P6 above with:

- Galvanized steel wall mount bracket (no legs)
- Shipping weight: 31 lbs.



41AF

Filter Cartridge

- Filter cartridge for 41A, 41P2, 41P6 and 41P6WM
- Shipping weight: 6 lbs.













Now molded from environmentally friendly recycled plastic. Color may vary.



 Best Seller

Breathing Air Filtration

41 Series Filter Replacement Parts

41ATOPYLW	41A Manifold Plate for 41A Filter <ul style="list-style-type: none">Regulator relief valve, and pressure gauge not included	
41P2M	41P2 Manifold Assembly for 41P2 Filter <ul style="list-style-type: none">Steel manifold plateRegulator adjustable between 0-100 psigRelief valve set at 125 psigPressure gaugeShipping weight: 7.0 lbs.	
41P6UPK	41P6 Manifold Assembly for 41P6 Filter <ul style="list-style-type: none">Steel manifold plateRegulator adjustable between 0-100 psigRelief valve set at 125 psigPressure gaugeShipping weight: 10.0 lbs.	
41RG	Regulator Gauge <ul style="list-style-type: none">For 41P2 and 41P60-160 psi	
41PRV	Pressure Relief Valve <ul style="list-style-type: none">For 41P2 and 41P6125 psig activation	
41P2R	41P2 Regulator and Gauge Assembly <ul style="list-style-type: none">For use with flat top design only	
41P6R	41P6 Regulator, no gauge or connection fittings	
V15	Industrial Interchange Female Coupler <ul style="list-style-type: none">3/4" Industrial Interchange (Hansen compatible) quick-disconnect couplerIncludes shut-off with 3/8" male pipe thread (NPT)	
41KB2	Replacement Knob for 41P2	
41HK	Handle Kit <ul style="list-style-type: none">For use with all 41 Series Airline Filters	
41DRAIN	Petcock	
41ACABKIT	Connection kit from 41A to a Clean Air Box (CAB) (not pictured) <ul style="list-style-type: none">Includes two reducersIncludes Industrial Interchange (Hansen Compatible) Coupler	



Clean Air Box (CAB) Series Breathing Air Filtration

Clean Air Boxes (CAB)

High Performance Air Filtering and Monitoring

Clean Air Boxes can help employers comply with Grade D breathing standards by providing high-performance particulate filtration and continuous Carbon Monoxide (CO) monitoring. Available as either portable case, enclosed, or fixed wall mount, these units feature high-performance three-stage filtration, auto-drains, CO monitoring, filter change indicators, and the capacity to support up to eight workers.

Remote Air Manifold (RAM)

Air Distribution and Regulation

Remote Air Manifolds are effective for air distribution and regulation to multiple workers from a common air source. Standard features include multiple respirator couplings, single or multiple pressure regulators, and a rugged Pelican™ protective case.

Carbon Monoxide (CO) Monitors

Continuous Monitoring for Carbon Monoxide

This compact, durable unit connects easily to any compressed breathing air source (connection kit included). The monitor is factory set to sound a 93dB alarm when CO level exceeds 10ppm, the OSHA limit. Monitors are also available with a CO alarm set point of 5ppm to meet Canadian Standards Association (CSA) and certain international requirements. External operation lights show green for normal and red for alarm for easy visual monitoring. An alarm jack to allow connection to remote alarm devices is standard. Monitors operate on 9-volt battery or 110-volt AC power. Backup battery power supply capability is standard on all units.



CAB Series Sizing Chart

*This chart is intended solely as a guide. The actual number of respirators that may be connected to these products is dependent on the inlet pressure to the panel and the airflow and pressure requirements of the respirator.

Number of Workers	Mask Respirators	Hood Respirators	Hood Respirators with Cool Tubes*
1	CAB15	CAB15	CAB15
2	CAB15 or COHP41P2	CAB30 or COHP41P2	CAB30 or COHP41P2
3	CAB15 or COHP41P6	CAB30 or COHP41P6	CAB50 or COHP41P6
4	CAB30 or COHP41P6	CAB50 or COHP41P6	CAB50 or COHP41P6
5	CAB30 or COHP41P6	CAB50 or COHP41P6	CAB100 or COHP41P6
6	CAB30 or COHP41P6	CAB100 or COHP41P6	CAB100 or COHP41P6
7	CAB50 or COHP41P6	CAB100 or COHP41P6	CAB100
8	CAB50 or COHP41P6	CAB100 or COHP41P6	CAB100

* Single Cool Tubes

RAM Series Sizing Chart

Number of Workers	Mask Respirators	Hood Respirators	Hood Respirators with Cool Tubes*
1	RAM1	RAM1	RAM1
2	RAM2	RAM2	RAM2
3	RAM4	RAM4	RAM4
4	RAM4	RAM4	RAM4
5	RAM8	RAM8	RAM8
6	RAM8	RAM8	RAM8
7	RAM8	RAM8	RAM8
8	RAM8	RAM8	RAM8

* Single Cool Tubes

CAB Breathing Air Filtration

CO Monitoring Systems

10 PPM PART NUMBER	5 PPM PART NUMBER	
COHP	CO5HP	CO Monitor System for High Pressure
COHP41P2	CO5HP41P2	75 cfm, two-outlet unit
COHP41P6	CO5HP41P6	75 cfm, six-outlet unit
COHP41P2CABCK	CO5HP41P2CABCK	75 cfm, two-outlet unit • Calibration Kit Included
COHP41P2WMCABCK	CO5HP41P2WMCABCK	75 cfm, two-outlet unit • Calibration Kit Included • Wall Mount Bracket Included



COHP41P2

CO Monitor Series Accessories

COHPKIT	Connection Kit from COHP to Filter • Includes colder coupler, connection hose, and brass bushing
COHPAK	COHP Connector Hose • Only connector hose is included (Tygon® Tubing)
COHPCC	Replacement Colder Coupler • Female fitting on end of connector hose



CAB Series Portable Filtration and CO Monitoring

One-Worker System with Tychem® Respirator

All assemblies include a Clean Air Box, 3-stage filtration, visual filter change indicators, CO monitor with auto-calibration, and audible and visual alarms for high CO and low battery. Respirator includes DuPont™ Tychem® hood, AC1000 cool tube, breathing tube, and 25' breathing hose assembly.

10 PPM PART NUMBER	5 PPM PART NUMBER	
CAB15HASYS*	CAB15HASYS5*	15 cfm Clean Air Box System with 20TIC DuPont™ Tychem® Hood Respirator



CAB15HASYS

One-Worker System with Spectrum Series® Respirator

All assemblies include a Clean Air Box, 3-stage filtration, visual filter change indicators, CO monitor with auto-calibration, and audible and visual alarms for high CO and low battery. Respirator includes Spectrum Series® mask and 100' breathing hose assembly.

10 PPM PART NUMBER	5 PPM PART NUMBER	
SPECLCABSYS	SPECLCABSYS5	15 cfm Clean Air Box System with Spectrum Series® Mask Respirator



SPECLCABSYS

One Worker System with Blasting Respirator

All assemblies include a Clean Air Box, 3-stage filtration, visual filter change indicators, CO monitor with auto-calibration, audible and visual alarms for high CO and low battery. Respirator includes 88VX3230 hood, AC1000 cool tube, breathing tube and 25' breathing hose assembly.

10 PPM PART NUMBER	5 PPM PART NUMBER	
CAB15HA88VXSYS*	CAB15HA88VXSYS5*	15 cfm Clean Air Box System with 88VX3230 Blasting Respirator



CAB15HA88VXSYS

* Requires upgrade kit for use with Remote Alarm

Best Seller

877-BULLARD (285-5273) • International calls +1-859-234-6616



Clean Air Box (CAB) Filtration

CAB Series Portable Filtration and CO Monitoring

All assemblies include 3-stage filtration, visual filter change indicators, automatic filter drains, CO monitor with auto calibration, audible and visual alarms for high CO and low battery, 6-foot 110V AC power cord and remote alarm jack (except for CAB15). Remote Alarm and calibration kits are sold separately.

Pelican™ Case Unit

Single Regulator Manifolds

10 PPM PART NUMBER	5 PPM PART NUMBER
-----------------------	----------------------

CAB15XX	CAB15XX5	1-2 worker, 15 cfm (V25 splitter required for 2 workers)
 CAB30XX	CAB30XX5	1-2 worker, 30 cfm

Refer to XX key below.

CAB50XX	CAB50XX5	1-4 worker, 50 cfm
CAB100XX	CAB100XX5	1-8 worker, 100 cfm

CAB15RAUPGRADE CAB15 upgrade kit for use with Remote Alarm

CAB15HARAJ CAB15HA with Remote Alarm jack

Refer to XX key below.



CAB15HA



CAB30HA



CAB50HA



CAB100HA

Independent Regulators

10 PPM PART NUMBER	5 PPM PART NUMBER
-----------------------	----------------------

CAB30IRXX	CAB30IRXX5	1-2 worker, 30 cfm
CAB50IRXX	CAB50IRXX5	1-4 worker, 50 cfm
 CAB100IRXX	CAB100IRXX5	1-8 worker, 100 cfm



CAB30IRHA



CAB50IRHA



CAB100IRHA

XX Key for Outlet Couplers

When placing an order indicate your choice of outlet coupler for each CAB.

- HA - Hansen/Industrial Interchange Coupler
- SC - Schrader Coupler
- SN - Snap-Tite Coupler
- CE - CEJN Coupler
- SS - Stainless Hansen/Industrial Interchange Coupler

Clean Air Box Breathing Air Filtration

CAB Series Portable Filtration and CO Monitoring

All assemblies include 3-stage filtration, visual filter change indicators, automatic filter drains, CO monitor with auto calibration, audible and visual alarms for high CO and low battery, 6 foot 110V AC power cord, and remote alarm jack (except for CAB15). Remote Alarm and calibration kits are sold separately.



Panel Mount Units

Single Regulator Manifolds

10 PPM PART NUMBER	5 PPM PART NUMBER	
CAB15PMXX	CAB15PMXX5	1-2 worker, 15 cfm (V25 splitter required for 2 workers)
CAB30PMXX	CAB30PMXX5	1-2 worker, 30 cfm



CAB15PM



CAB30PM

Refer to XX key below.

CAB50PMXX	CAB50PMXX5	1-4 worker, 50 cfm
CAB100PMXX	CAB100PMXX5	1-8 worker, 100 cfm



CAB50PM



CAB100PM

CAB15RAUPGRADE CAB15 upgrade kit for use with Remote Alarm

CAB15HARAJ CAB15HA with Remote Alarm jack

Refer to XX key below.

Independent Regulators

10 PPM PART NUMBER	5 PPM PART NUMBER	
CAB30PMIRXX	CAB30PMIRXX5	1-2 worker, 30 cfm
CAB50PMIRXX	CAB50IRXX5	1-4 worker, 50 cfm
CAB100PMIRXX	CAB100IRXX5	1-8 worker, 100 cfm



CAB30PMIR



CAB50PMIR

Refer to XX key below.

XX Key for Outlet Couplers

When placing an order, indicate your choice of outlet coupler for each CAB.

- HA - Hansen/Industrial Interchange Coupler
- SC - Schrader Coupler
- SN - Snap-Tite Coupler
- CE - CEJN Coupler
- SS - Stainless Hansen/Industrial Interchange Coupler



CAB100PMIR

Remote Air Manifolds (RAM)

RAM1WMHA One Outlet Remote Air Manifold with Hansen Outlet Coupling



RAM1WMHA

Single Regulator Manifolds

All assemblies include Pelican™ case, male inlet fitting, regulator(s), pressure gauge(s), and female quick-disconnect outlet coupling.

RAM1XX 1-2 worker



RAM1

RAM2XX 1-2 worker



RAM2

RAM4XX 1-2 worker



RAM4

RAM8XX 1-2 worker



RAM8

Refer to XX key below.

Independent Regulators

RAM2IRXX 1-2 worker, 30 cfm



RAM2IR

RAM4IRXX 1-4 worker, 15 cfm



RAM4IR

RAM8IRXX 1-8 worker, 15 cfm



RAM8IR

Refer to XX key below.

XX Key for Outlet Couplers

When placing an order indicate your choice of outlet coupler for each CAB.

- HA - Hansen/Industrial Interchange Coupler
- SC - Schrader Coupler
- SN - Snap-Tite Coupler
- CE - CEJN Coupler
- SS - Stainless Hansen/Industrial Interchange Coupler

Clean Air Box (CAB) Filtration

CAB Replacement Parts and Accessories

Calibration Kits and Gas

Full Kits

- CABCK** Calibration Kit (includes Zero Air 34L Cylinders, 10 ppm CO, Regulator, Tubing, and Connector)
Approximately 25 calibrations
- CABCK17L** Same as above, with 17L Cylinders - no carrying case
Approximately 12 calibrations
- CABCK103L** Same as above, with 103L Cylinders
Approximately 77 calibrations



CABCK

Replacement Cylinders

- CABCG0** Zero Air, 34L Cylinder (Regulator not included, order CABCALREG if needed)
- CABCG017L** Zero Air, 17L Cylinder (Regulator not included, order CABCALREG if needed)
- CABCG0103L** Zero Air, 103L Cylinder (Regulator not included, order CABCALREG103 if needed)
- CABCG10** 10 PPM CO, 34L Cylinder (Regulator not included, order CABCALREG if needed)
- CABCG1017L** 10 PPM CO, 17L Cylinder (Regulator not included, order CABCALREG if needed)
- CABCG10103L** 10 PPM CO, 103L Cylinder (Regulator not included, order CABCALREG103 if needed)

Other Replacement Items

- CABCALREG** Regulator, tubing and connector fitting for CABCK and CABCK17L calibration kits
- CABCALREG103** Regulator, tubing and connector fitting for CABCK103L calibration kit
- CABREGTB** Tygon® tubing for regulator
- CABLEDGR** Replacement LED Indicator Light, Green
- CABLEDRD** Replacement LED Indicator Light, Red
- CABLEDYW** Replacement LED Indicator Light, Yellow
- RA** Remote Alarm
- RA300** Remote Alarm with 300' Cable
- COM5** Replacement CO Monitor, 5ppm Alarm Set Point
- COM10** Replacement CO Monitor, 10ppm Alarm Set Point
- CABRS2** Replacement Sensor
- CABKS** Kickstand for 15-100 cfm CAB Models
- RACABLE** Replacement Cable 50'
- COHPKIT** Tygon® Tubing and Connector Kit
- COHPAK** COHPconnector hose (Tygon® Tubing)



CABKS - Kickstand



RA

Replacement Filters and Change Indicators for 15 & 30 cfm Models

- CAB30FA** Filter Stage 1 - 15 or 30 cfm (entire filter housing included)
- CAB30FB** Filter Stage 2 - 15 or 30 cfm (entire filter housing included)
- CAB30FC** Filter Stage 3 - 15 or 30 cfm (entire filter housing included)



CAB30FA

CAB30FB

CAB30FC

Replacement Filter Elements

- CAB30FK** Filter Element Kit, Includes CAB30FEA, CAB30FEB and CAB30FEC
- CAB30FEA** Filter Element A - Particulate (outer housing not included)
- CAB30FEB** Filter Element B - Coalescing (outer housing not included)
- CAB30FEC** Filter Element C - Activated Charcoal (outer housing not included)



CAB30FK

- CAB30ADA** Filter Auto Drain Bowl - 15 or 30 cfm



CAB30ADA

CAB Breathing Air Filtration Replacement Filters, Elements and Change Indicators

For 50 cfm Models

CAB50FA	Filter Stage 1 - 50 cfm
CAB50FB	Filter Stage 2 - 50 cfm
CAB50FC	Filter Stage 3 - 50 cfm
CAB50FK	Filter Element Kit
	• Includes CAB50FEA, CAB50FEB, and CAB50FEC
CAB50FEA	Filter Element A - Particulate
CAB50FEB	Filter Element B - Coalescing
CAB50FEC	Filter Element C - Activated Charcoal



For 100 cfm Models

CAB100FA	Filter Stage 1 - 100 cfm
CAB100FB	Filter Stage 2 - 100 cfm
CAB100FC	Filter Stage 3 - 100 cfm
CAB100FK	Filter Element Kit
	• Includes CAB100FEA, CAB100FEB, and CAB100FEC
CAB100FEA	Filter Element A - Particulate
CAB100FEB	Filter Element B - Coalescing
CAB100FEC	Filter Element C - Activated Charcoal
CAB100MB	Mounting Block



Filter Change Indicator

CAB15FCI	Filter Change Indicator 15 cfm
CAB30FCI	Filter Change Indicator 30 cfm
CAB50FCIA	Filter Change Indicator 50 cfm, Stage 1
CAB50FCIB	Filter Change Indicator 50 cfm, Stage 2
CAB100FCIA	Filter Change Indicator 100 cfm, Stage 1
CAB100FCIBC	Filter Change Indicator 100 cfm, Stages 2 and 3



Replacement Regulators and Parts

CABREG1	Replacement Regulator 15 and 30
CABREG2	Replacement Regulator 50
CABREG3	Replacement Regulator 100
CABREG4	Replacement Independent Regulator
CABQDHA	Quick-Disconnect Outlet Fitting Hansen (v14)
CABQDSN	Quick-Disconnect Outlet Fitting Snap Tite
CABQDSC	Quick-Disconnect Outlet Fitting Schrader
CABQDCE	Quick-Disconnect Outlet Fitting CEJN
CABQDSS	Quick-Disconnect Outlet Fitting Hansen Stainless Steel
CABQDNV	Quick-Disconnect Outlet Fitting Nova
CABQDCAP	Quick-Disconnect Dust Cap
41PRV	Pressure Relief Valve, 125psi - All CAB and RAM Units
S196810	Replacement Gauge (CAB30)
CABFR	CAB Fuse Replacement Kit
S17456	Inlet fitting



Power Cords

CABCORDJA	6-Foot Power Cord for Japan
CABCORDUK	6-Foot Power Cord for United Kingdom
CABCORDAU	6-Foot Power Cord for Australia
CABCORDEU	6-Foot Power Cord for Europe
CABPC	U.S. Powercord
V25HA	CAB Hansen, 2-person, Outlet Coupling Splitter
41ACAB	CAB Hansen, 2-person, Outlet Coupling Splitter
41ACABKIT	Connection Kit for 41 Filter to CAB





Free-Air® Pumps

Reliable, Economical Air Sources for Airline Respirators.

Easy to operate and maintain, Bullard Free-Air® pumps offer a low-cost way to supply clean, breathable air to workers in contaminated environments. They are an economical air source when compressed air is not available and an inexpensive way to add breathing capacity when a compressed air source is at its maximum utilization.

Economical

Bullard Free-Air® pumps are efficient and economical. They are portable and can be moved quickly and easily from job site to job site. Plus, they require no expensive plumbing or installation. Bullard Free-Air® pumps are oil-less, so they do not produce carbon monoxide, oil vapor, or oil mist. Since Carbon Monoxide (CO) monitors, temperature alarms, airline filters, and complicated calibration equipment aren't necessary, Free-Air® pumps are frequently a more cost-effective alternative to compressed air.

Easy-To-Use

Bullard Free-Air® pumps are reliable and easy to use. They are available in both electric and air driven models. Electric models have low power requirements; simply plug in, set the proper air pressure, and go to work. The air-driven model is ideal for both general purpose and hazardous duty use. Used with optional extension hose kits, the breathable air inlet can be located up to 300 feet away from the pump.

Pump and Number of Workers

Model	Cubic Feet Per Minute (CFM)	Number of Workers Wearing Hoods	Number of Workers Wearing Masks	Cooling Options
ADP20	11-31	4	6	Frigitron2000 (1 worker max)
EDP10	10	1	2	None
EDP16TE	16	2	4	None
EDP16HAZ	16	2	4	None
EDP30	30	4	6	Frigitron2000 (2 worker max)
EDP50	50	7	10	None
ICE Pump	8-11	1	1	Frigitron2000 (1 worker max)

*AC1000 with Spectrum Series® - CF Only

Thermal Overload Tips

- Always use 1/2" Connections
- Always use 1/2" Inner Diameter (ID) Hose
- Only use Cool Tubes when compatible
- Never exceed recommended operating pressures
- Always use a heavy-duty extension cord (10 or 12 American Wire Gauge (AWG), 20 amp is recommended)

ICE® Pump

Electric-Driven Pumps - 8 cfm

ICEPUMP11 2HP Electric-Driven, Oil-Less Air Pump with drip-proof motor drive



- Portable with standard wheel kit and roll cage
- Supplies air to one hood-style or mask-style respirator
- Provides 15°F+ (9.5°C+) of ambient cooled air, when used with Bullard's Frigatron2000
- Inlet and Outlet filter cartridges
- Liquid filled Pressure gauge (0-100 psig)
- 6' Electrical cord and On/Off switch (Nema 5-20 Plug)
- One ½" Industrial Interchange (Hansen compatible) quick-disconnect coupler
- Pump Weight: 100 lbs (45KG).
- Shipping Weight: 185 lbs (84KG).



ICE Pump (ICEPUMP11) Electrical Motor Specifications

Enclosure: Open, Drip-proof
Meets UL Requirements,
CSA Approved

Class: Natl. Elec. Code:
Class B
Design N
Code K

H.P. 2.0
Phase: Single
Cycles: 60 Hz
Volts: 110/120
Amps: 19 @ 115
Service Factor: 1.25
Protector: Internal Thermal Overload

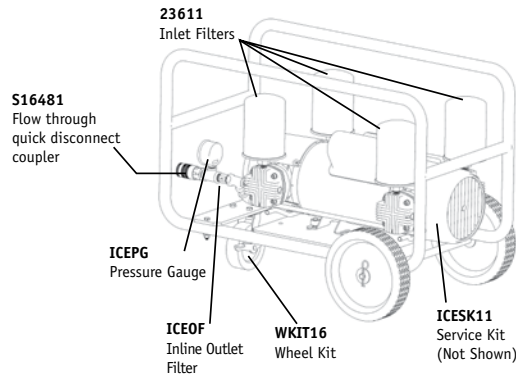

ICEPUMP11 Replacement Parts

23611 Inlet Filter

- Change every 500 hours or as required
- One required for EDP10, EDP16TE/HAZ, ADP20; two required for EDP30 & EDP50



ICEOF Inline Outlet Filter, 90 micron



V50IN Remote inlet air hose kit, 50' (four needed per pump)



V50EX Remote extension air hose kit, 50' (five per inlet maximum)



ICE® Pump

ICEPUMP11 Replacement Parts

ICEPG Pressure gauge, liquid-filled, 0-100 Pounds Per Square Inch, Gage (PSIG)



ICESK11 Service Kit, ICEPUMP11. Includes Gasket Heads, Cylinders, Seals, Valves, Sleeves, Rings, and Spacers.



FRIGITRON2000 Climate control device, Industrial Interchange (Hansen Compatible)



V20100ST 1/2" Industrial Interchange (Hansen compatible) Quick Disconnect (QD) coupler and nipple, 100' Breathing Air Hose



WKIT16 Wheel Kit Assembly



S16481 Quick-Disconnect Coupler
• 1/2" Industrial Interchange (Hansen compatible), flow-through
• 3/8" National Pipe Thread (NPT)



ICEXTCORD25 12 gauge, 20 Amp Extension cord. NEMA 5-20 plugs receptacle 25 feet.
ICEXTCORD50 12 gauge, 20 Amp Extension cord. NEMA 5-20 plugs receptacle 50 feet.

Electric-Driven Pumps - 10 cfm



EDP10 One- to Two-Person Pump
EDP10HM One- to Two-Person Pump (With Run Hour Meter)
• 3/4 HP electric-driven, oil-less air pump with open drip-proof motor drive
• Supplies air to one hood-style or two half- or full-face mask airline respirators
• Carrying handle
• Inlet and outlet filter cartridges
• Pressure gauge (0-30 psig)
• 6' Electrical cord and On/Off switch
• One 1/2" Industrial Interchange (Hansen compatible) quick-disconnect coupler
• Shipping Weight: 60 lbs (27KG).

EDP1050HZ220V One- to Two-Person Pump
• 220V 50HZ version

EDP1050HZ220VHM One- to Two-Person Pump (With Run Hour Meter)



EDP10

 Best Seller

877-BULLARD (285-5273) • International calls +1-859-234-6616

Free-Air® Pumps

EDP10 Electrical Motor Specifications

Enclosure: Open, Drip-proof
Meets UL Requirements,
CSA Approved

Class: Natl. Elec. Code:
Class B
Design N
Code K

H.P. 3/4
Phase: Single
Cycles: 60 Hz
Volts: 115
Amps: 10.2 @ 115 V
Service Factor: 1.25
Protector: Internal Thermal Overload

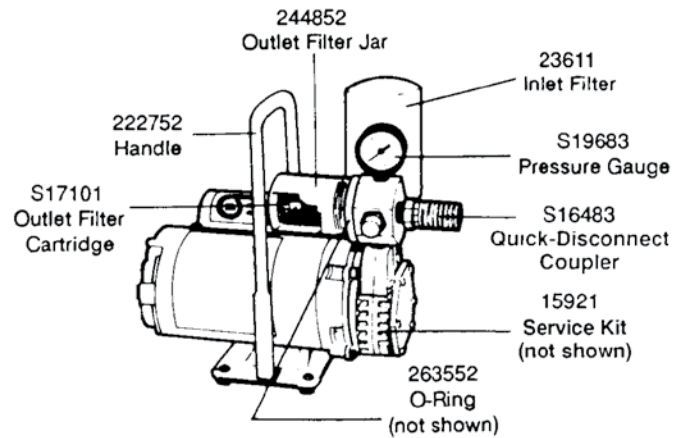

EDP10

EDP1050HZ220V Electrical Motor Specifications

Enclosure: Open, Drip-proof
Meets UL Requirements,
CSA Approved

Class: Natl. Elec. Code:
Class B
Design N
Code K

H.P. 1
Phase: Single
Cycles: 50 Hz
Volts: 110/220
Amps: 10 @ 110 V / 5.3 @ 220 V
Service Factor: 1.15
Protector: Internal Thermal Overload

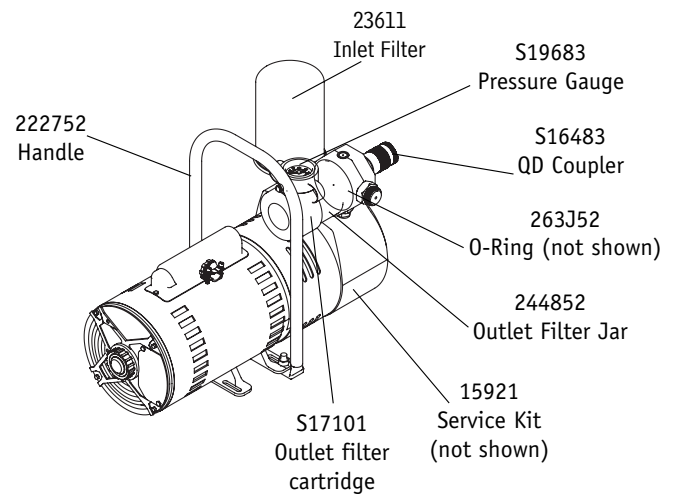

EDP1050HZ220V

EDP10 Replacement Parts

- 15921** Service Kit for EDP10
 - Four carbon vanes (VANEEDP10)
 - Inlet filter (23611)
 - Outlet filter cartridge (S17101)
- 15923** Service Kit for EDP1050HZ220V
- VANEEDP10** Vane Replacement Kit for EDP10 (set of 4 vanes)



- S19683** Pressure Gauge, 0-30 psi
- EDP10PRV** Pressure relief valve



- S16483** Quick-Disconnect Coupler
 - 1/2" Industrial Interchange (Hansen Compatible), flow-through
 - 3/4" NPT pipe thread















- 23611** Inlet Filter
 - Change every 500 hours or as required
 - One required for EDP10, EDP16TE/HAZ, ADP20; two required for EDP30 & EDP50
four required for ICEPUMP11



- 23612** For EDP2A retrofit kit
- 23613** For EDP1A retrofit kit
- HEXADAPTOR** Bushing for EDP10 inlet filter

Free-Air® Pumps

EDP10 Replacement Parts

244852	Outlet Filter Jar	
INLINE10	Replacement Inline Filter Assembly for remote re-locating of outlet	
263552	Outlet Filter Assembly O-Ring	
S17101	Outlet Filter <ul style="list-style-type: none"> • Carbofine (change every 200 hours or as required) • One required for EDP10, EDP16TE/HAZ, ADP20; four required for EDP30; eight required for EDP50 	
222752	Carrying Handle	
S17931	Cleaning Solvent, 14 oz. Aerosol Can	
V22	Quick-Disconnect Coupler Adapter <ul style="list-style-type: none"> • Converts pump's quick-disconnect coupler to double 3/8" female NPT 	
V23	Quick-Disconnect Adapter <ul style="list-style-type: none"> • Converts pump's quick-disconnect coupler to single 3/8" female NPT 	
V24	Quick-Disconnect Coupler Splitter/Adapter <ul style="list-style-type: none"> • Converts pump's quick-disconnect coupler to double 1/2" Industrial Interchange female couplers (one flow-through, one shut-off) 	
V50EX	Remote Extension Hose Kit <ul style="list-style-type: none"> • 50-ft. length • Connects to V50IN to extend length • Maximum five per pump • 1 1/2" ID 	
V50IN	Remote Inlet Air Hose Kit <ul style="list-style-type: none"> • 50-ft. length • Connects to pump for remote location of inlet filter • Maximum one per pump • 1 1/2" ID 	
V50INF	Remote Inlet Air Hose Fittings Kit	
HM	Run Hour Meter-Field Conversion Kit	



Free-Air® Pumps

Electric-Driven Pumps - 16 cfm

- EDP16TE** Two- to Three-Person Pump
- 1 1/2 HP electric-driven, oil-less air pump with totally enclosed fan-cooled motor drive (TFEC)
 - Supplies air to two hood-style or three half- or full-face mask airline respirators
 - Inlet and outlet filter cartridges
 - Pressure gauge (0-30 psig)
 - Electrical cord and On/Off switch
 - Two 1/2" Industrial Interchange (Hansen compatible) quick-disconnect couplers
 - Shipping Weight: 100 lbs (45KG)

EDP16TE60HZ220V Same as EDP16TE wired for 220V, 60Hz

EDP16TEW EDP16TE pump with wheel kit

WKIT16 Wheel Kit for EDP16 Pump, Field Conversion

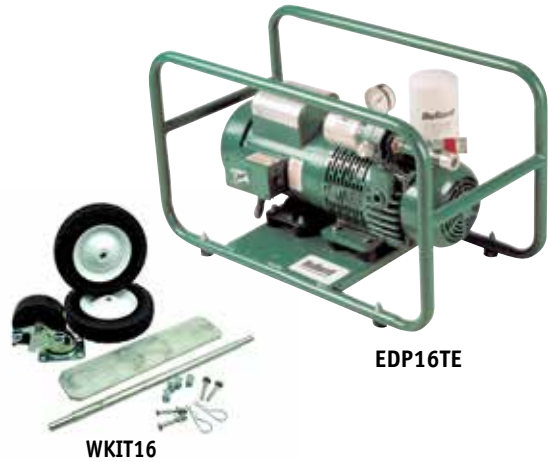

EDP16TE Electrical Motor Specifications

- Enclosure:** Totally-Enclosed, Fan Cooled
Capacitor Start
- Meets UL Requirements, CSA Approved
- Class:** Natl. Elec. Code:
Class III
Division 1 and 2
- H.P.:** 1.5
- Phase:** Single
- Cycles:** 60 Hz
- Volts:** 115/208/230
(Connected for 115 V.)
- Amps:** 16.0 @ 115 V
8.0 @ 208/230 V.
- Service Factor:** 1.15
- Protector:** Manual Reset Thermal Overload equipped for 115 volt operation.
- Thermal Overload and Starter/Contactor to be provided by the user if rewired to 208/230 volts.

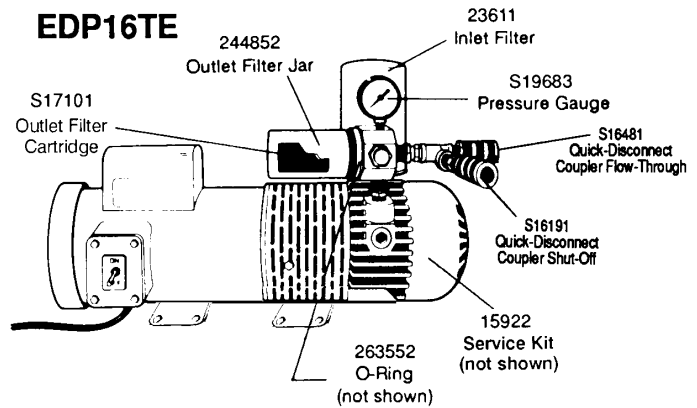

Free-Air® Pumps

EDP16HAZ

- EDP16HAZ** Two-to-Three-Person Hazardous Duty Pump (Not Pictured)
- 1½ HP electric-driven, oil-less air pump with hazardous-duty motor (Explosion Proof)
 - Supplies air to two hood-style or three half- or full-face mask airline respirators
 - Inlet and outlet filter cartridges
 - Pressure gauge (0-30 psig)
 - Starter/contactor to be supplied by user
 - Two ½" Industrial Interchange (Hansen compatible) Quick-Disconnect couplers
 - Shipping Weight: 100 lbs (45KG).

EDP16HAZW With Wheels for ease of mobility



EDP16HAZ Electrical Motor Specifications

Enclosure:	Hazardous Duty
	Meets UL Requirements, CSA Approved
Class:	National Electric Code: Class I, Group D, Div. 1 & 2 Class II, Group F, Div. 1 & 2 Class II, Group G, Div. 1 & 2 Class III, Division 1 & 2<
H.P.:	1.5
Phase:	Three
Cycles:	60 Hz
Volts:	230-460
Amps:	5.0 @ 230 V 2.5 @ 460 V
Service Factor:	1.0
Protector:	Thermal Overload and Starter/Contactor to be provided by the user.

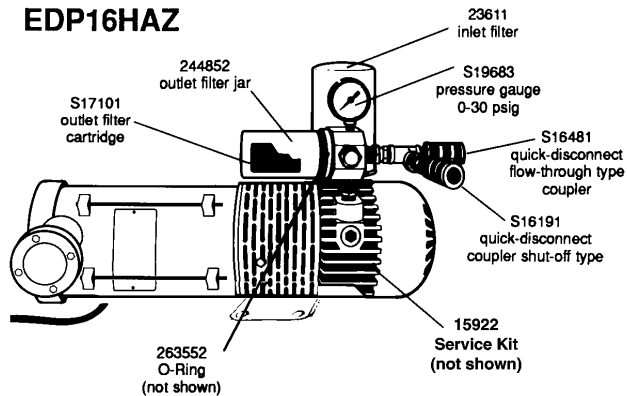

EDP16HAZ/EDP16TE Replacement Parts

- 15922** Service Kit
- Four carbon vanes (VANE1620)
 - 23611 inlet filter
 - S17101 outlet filter cartridge



- VANE1620** Pressure Gauge, 0-30 psi



- S19683** Pressure Gauge, 0-30 psi



Free-Air® Pumps

EDP16HAZ/EDP16TE Replacement Parts

INLINE16 Replacement Inline Filter Assembly for remote re-locating of outlet



S16191 Quick-Disconnect Coupler
• 1/2" Industrial Interchange (Hansen compatible), shut-off
• 3/8" NPT Pipe Thread
• Red Band



S16481 Quick-Disconnect Coupler
• 1/2" Industrial Interchange (Hansen compatible), flow-through
• 3/8" NPT Pipe Thread
• Green Band



23611 Inlet Filter
• Change every 500 hours or as required
• One required for EDP10, EDP16TE/HAZ, ADP20; two required for EDP30 & EDP50, four required for ICEPUMP11



244852 Outlet Filter Jar



263552 Outlet Filter Assembly O-Ring



S17101 Outlet Filter
• Carbofine (change every 200 hours or as required)
• One required for EDP10, EDP16TE/HAZ, ADP20; four required for EDP30; eight required for EDP50



S17931 Cleaning Solvent, 14 oz. Aerosol Can



Free-Air® Pumps

EDP16HAZ/EDP16TE Replacement Parts

V22

Quick-Disconnect Coupler Adapter

- Converts pump's quick-disconnect coupler to double $\frac{3}{8}$ " Female NPT



V23

Quick-Disconnect Adapter

- Converts pump's quick-disconnect coupler to single $\frac{3}{8}$ " Female NPT



V24

Quick-Disconnect Coupler Splitter/Adapter

- Converts pump's quick-disconnect coupler to double $\frac{1}{2}$ " Industrial Interchange female couplers (one flow through, one shut-off)



V50EX

Remote Extension Hose Kit

- 50-ft. length
- Connects to V50IN to extend length
- Maximum five per pump
- $1\frac{1}{2}$ " ID



V50IN

Remote Inlet Air Hose Kit

- 50-ft. length
- Connects to pump for remote location of inlet filter
- Maximum one per pump
- $1\frac{1}{2}$ " ID



Free-Air® Pumps

Electric-Driven Pumps - 30 cfm

Electric Driven, Oil-less Air Pump

- All motors are open drip-proof
- Supplies air to:
 - Four hood-style; or
 - Six half- or full-face mask airline respirators; or
 - Two hood-style respirators equipped with FRIGITRON climate control devices.
- Respirators must be approved to operate on 30 psig or less
- Shipped complete with inlet and outlet filter cartridges, pressure gauges, pressure relief valves and one air supply hose Quick-Disconnect pod with six 1/2" Industrial Interchange (Hansen compatible) quick-disconnect couplers
- Three phase motors come standard with protective reversing starters to prevent running backwards
- Shipping weight: 292 lbs (132KG).



NOTE: EDP30 pumps are custom built to your specifications. Contact Bullard Customer Service for lead time information

EDP30A208 Single Phase 5 HP Motor, 208 Volt

EDP30A230 Single Phase 5 HP Motor, 230 Volt

EDP30B208 Three Phase 5 HP Motor, Reversing Starter, 208 Volt

EDP30B230 Three Phase 5 HP Motor, Reversing Starter, 230 Volt

EDP30B460 Three Phase 5 HP Motor, Reversing Starter, 460 Volt

EDP30C230 Three Phase 7.5 HP Motor, Reversing Starter, 230 Volt

EDP30C460 Three Phase 7.5 HP Motor, Reversing Starter, 460 Volt

Electric-Driven Pumps - 50 cfm

Electric Driven, Oil-less Air Pump

- All motors are open drip-proof
- Supplies air to:
 - Seven hood-style; or
 - Ten half- or full-face mask airline respirators
- Respirators must be approved to operate on 15 psig or less
- Shipped complete with inlet and outlet filter cartridges, pressure gauges, pressure relief valves and two air supply hose quick-disconnect pods with six 1/2" Industrial Interchange (Hansen compatible) Quick-Disconnect couplers
- Three phase motors come standard with protective reversing starters to prevent running backwards.
- Shipping weight: 317 lbs (144KG).



NOTE: EDP50 pumps are custom built to your specifications. Contact Bullard Customer Service for lead time information.

EDP50A208 Single Phase 5 HP Motor, 208 Volt

EDP50A230 Single Phase 5 HP Motor, 230 Volt

EDP50B208 Three Phase 5 HP Motor, Reversing Starter, 208 Volt

EDP50B230 Three Phase 5 HP Motor, Reversing Starter, 230 Volt

EDP50B460 Three Phase 5 HP Motor, Reversing Starter, 460 Volt

EDP50C208 Three Phase 7.5 HP Motor, Reversing Starter, 208 Volt

EDP50C230 Three Phase 7.5 HP Motor, Reversing Starter, 230 Volt

EDP50C460 Three Phase 7.5 HP Motor, Reversing Starter, 460 Volt

Free-Air® Pumps

EDP30 and EDP50 Replacement Parts

- V60** Pod Extension Hose
- 100 Feet
 - 1 $\frac{1}{4}$ " ID
 - Three per pod maximum



- 26701** Pod Gasket (Filter Side)



- 27161** Pod Gasket (Cover Side)



- 26781-EDP30** Pod Assembly
26781-EDP50 Pod Assembly

- Pod Assemblies allow the point of connection to be moved closer to the worker while still keeping the pump at an optimal distance for noise, fresh-air, etc.



- 28151** EDP30 Pressure Relief Valve



- 28152** EDP50 Pressure Relief Valve



- S16191** Quick-Disconnect Coupler
- $\frac{1}{2}$ " Industrial Interchange (Hansen compatible), shut-off
 - $\frac{3}{8}$ " NPT pipe thread



- EDP30WHEEL** Replacement Wheel, 10" rubber wheel, includes cotter-pin (1ea)
EDP50WHEEL



Free-Air® Pumps

EDP30 and EDP50 Replacement Parts

- S19683** Pressure Gauge, 0-30 psi
• For EDP30 and EDP50 pod



-
- S19688** Pressure Gauge, 0-60 psi
• For EDP30 and EDP50 manifold



-
- S2084** EDP30 Drive Belt (Matched Pair)



-
- S2089** Kamlok Adapter (Pod)
• 1 1/4" ID aluminum



-
- S2090** Kamlok Coupler (Manifold)
• 1 1/4" ID aluminum



-
- 15924** Service Kit
• Four carbon vanes
• Two bearings
• Two cover gaskets



Free-Air® Pumps

EDP30 and EDP50 Replacement Parts

23611	Inlet Filter <ul style="list-style-type: none">• Change every 500 hours or as required• One required for EDP10, EDP16TE/HAZ, and ADP20; two required for EDP30 & EDP50	
244852	Outlet Filter Jar	
263552	Outlet Filter Assembly O-Ring	
S17101	Outlet Filter <ul style="list-style-type: none">• Carbofine (change every 200 hours or as required)• One required for EDP10, EDP16TE/HAZ, ADP20; four required for EDP30; eight required for EDP50	
S17931	Cleaning Solvent, 14 oz. Aerosol Can	
V22	Quick-Disconnect Coupler Adapter <ul style="list-style-type: none">• Converts pump's quick-disconnect coupler to double 3/8" Female NPT	
V23	Quick-Disconnect Adapter <ul style="list-style-type: none">• Converts pump's quick-disconnect coupler to single 3/8" Female NPT	
V24	Quick-Disconnect Coupler Splitter/Adapter <ul style="list-style-type: none">• Converts pump's quick-disconnect coupler to double 1/2" Industrial Interchange female couplers (one flow through, one shut-off)	
V50EX	Remote Extension Hose Kit <ul style="list-style-type: none">• 50-ft. length• Connects to V50IN to extend length• Maximum five per pump• 1 1/2" ID	
V50IN	Remote Inlet Air Hose Kit <ul style="list-style-type: none">• 50-ft. length• Connects to pump for remote location of inlet filter• Maximum one per pump• 1 1/2" ID	



Free-Air® Pumps

Air-Driven Pumps - 30 cfm

- ADP20** Air-Driven, Oil-Less Air Pump
- Supplies air to four hood-style respirators or six half- or full-face mask respirators
 - 30 cfm at 5 psi with minimum 85 cfm at 95 psi incoming drive air pressure
 - Intrinsically safe
 - Pressure gauge (0-30 psig)
 - Two 1/2" Industrial Interchange (Hansen compatible) quick-disconnect couplers
 - Shipping Weight: 100 lbs (45KG).

ADP20 Replacement Parts

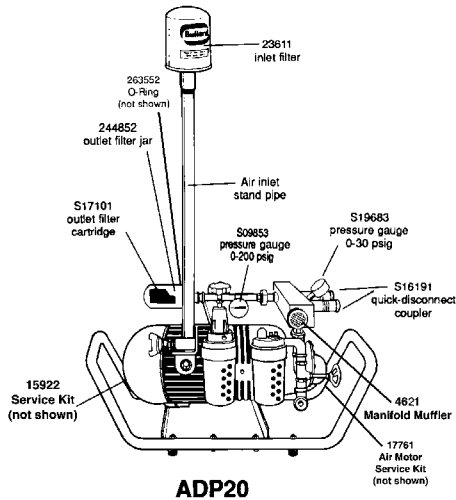

ADP20 Replacement Parts

- 17761** Service Kit for Air Motor
- Four carbon vanes
 - Two motor bearings
 - Four vane springs
 - Seal
 - Two body gaskets
 - Two push pins
 - End cap gasket
 - O-ring



- LUBREG** Lubricator Regulator



ADP20 Replacement Parts

- S09853** Pressure Gauge, 0-200 PSI



Free-Air® Pumps

ADP20 Replacement Parts

15922	Service Kit for Pump <ul style="list-style-type: none">• Four carbon vanes (VANE1620)• Inlet filter (23611)• Outlet filter cartridge (S17101)	
VANE1620	Pressure Gauge, 0-30 psi	
4621	ADP20 Manifold Muffler	
21052	Conversion Kit <ul style="list-style-type: none">• Conversion components - ADP16 or ADP3CA to ADP20	
S19683	Pressure Gauge, 0-30 psi	
S16191	Quick-Disconnect Coupler <ul style="list-style-type: none">• 1/2" Industrial Interchange (Hansen compatible), shut-off• 3/8" NPT Pipe Thread	
23611	Inlet Filter <ul style="list-style-type: none">• Change every 500 hours or as required• One required for EDP10, EDP16TE/HAZ, ADP20; two required for EDP30 & EDP50, Four required for ICEPUMP11	
244852	Outlet Filter Jar	
263552	Outlet Filter Assembly O-Ring	
S17101	Outlet Filter <ul style="list-style-type: none">• Carbofine (change every 200 hours or as required)• One required for EDP10, EDP16TE/HAZ, ADP20; 4 required for EDP30; eight required for EDP50	



Free-Air® Pumps

ADP20 Replacement Parts

S17931 Cleaning Solvent, 14 oz. Aerosol Can



V22 Quick-Disconnect Coupler Adapter
• Converts pump's quick-disconnect coupler to double 3/8" female NPT



V23 Quick-Disconnect Adapter
• Converts pump's quick-disconnect coupler to single 3/8" female NPT



V24 Quick-Disconnect Coupler Splitter/Adapter
• Converts pump's quick-disconnect coupler to double 1/2" Industrial Interchange female couplers (one flow through, one shut-off)



V50EX Remote Extension Hose Kit
• 50-ft. length
• Connects to V50IN to extend length
• Maximum five per pump
• 1 1/2" ID



V50IN Remote Inlet Air Hose Kit
• 50-ft. length
• Connects to pump for remote location of inlet filter
• Maximum one per pump
• 1 1/2" ID



Part Number Product Index

Part Number	Page Number				
6S24.....	6, 36, 43	20TG.....	85, 101, 155	41RG	210
8S24.....	6, 36, 43	20TIC.....	62, 81, 98	46VX.....	129, 141, 142,
9CP	16	20TICH.....	60, 63, 77, 82,		143, 148
9CR	16		94, 96, 97, 99	51P	18
9HP	16	20TICH30R	82, 99	51R	18
9HR.....	16	20TICH51R	82, 99	61P	18
13VX.....	141, 142, 148	20TICHT	60, 82	61R	18
20BT.....	94, 108, 118,	20TICHT30R.....	82	62P	18
	121, 125, 154,	20TICHTS51R.....	82	62R	18
	159, 160	20TICN.....	60, 81, 94, 95,	71P	18
20LC.....	161		97, 98	71R	18
20LCL	85, 94, 97, 101	20TICNT	81	77GLT	151
20LCLBP.....	85, 101	20TICNX	81, 98	77LG.....	151
20LF2L.....	60, 64, 77, 78,	20TICNXT.....	81	88CA.....	150
	110, 112	20TICS	62, 82, 99	88CK.....	147
20LF2L50.....	112	20TICSN	82, 99	88CS.....	150
20LF2M	60, 64, 78, 110,	20TICSNT.....	60, 82	88VX.....	152
	112	20TICST.....	62, 82	88VX36XL30	143
20LF2M50.....	112	20TICT	81	88VX1330.....	142
20LF2S.....	60, 64, 78, 110,	20TJ	62, 81, 98	88VX1335.....	143
	112	20TJN	60, 81, 94, 95, 98	88VX3230.....	142, 212
20LF2S50	112	20TJNT.....	81	88VX3230H.....	142
20LFBT	108, 113, 116	20TJT.....	81	88VX3231.....	142
20LFL.....	60, 64, 78, 81,	20TPC	77	88VX3235.....	143
	97, 110, 112	20TPCN	60	88VX3235H100.....	143
20LFL50	112	20TPCNT.....	60	88VX3240.....	142
20LFM.....	60, 64, 78, 81,	20TPN.....	60	88VX3630.....	143
	110, 112	28VX.....	129, 130, 131,	88VXAK	150
20NC.....	60, 85, 94, 101,		135	88VXBAIL	150
	129, 141, 142,	30BSW	203, 204	88VXBT	141, 142,
	143, 149, 154,	30P	15		143, 144, 147
	156	30R	15	88VXHP	150
20QCBTC.....	89, 108, 116, 125	30SSW.....	203, 204	88VXICESYS.....	143
20RT.....	60, 76, 81, 82,	30SW	204	88VXLC.....	129, 141, 151
	83, 84, 85, 94,	33P	15, 16	88VXOLG.....	152
	99, 100, 101,	33R	15, 16	88VXOLT	152
	154, 156	34P	15	88VXRTP.....	70, 129, 141,
20SIC.....	77, 83, 99	34R	15		149, 188
20SICH.....	60, 94, 100	36VX.....	129, 141, 148	88VXSYS	143
20SICHT	60	36XLVX.....	129, 141, 148	88VXSYS16TE.....	143
20SICN	60, 83, 94, 96,	38VX.....	129, 135	88VXTGP.....	150
	99	41A	208, 209	100G.....	6, 39
20SICNT	60, 83	41ACAB	217	110G.....	6, 39
20SICNX	83	41ACABKIT	210, 217	112G.....	6, 39
20SICNXT.....	83	41AF.....	209	300B	6, 38
20SICT	77, 83	41HK	209, 210	300BW	6, 38
20SICV	83	41KB2.....	210	312B	6, 38
20SICVH	83	41P2.....	208, 209, 210	400	6, 38, 44
20SICVHS51R	83	41P2M	210	400W	6, 38
20SICVHT	83	41P2R.....	210	500M	6, 39
20SICVHTC30R.....	83	41P2WM.....	209	640	6, 41
20SICVHTS51R.....	83	41P6.....	208, 209, 210	640G.....	6, 40
20SICVN	83	41P6R.....	210	640PW3.....	6, 36, 42
20SICVNT.....	83	41P6UPK	210	640PW5.....	6, 36, 42
20SICVT.....	83	41P6WM.....	208, 209	680P.....	6, 36, 41, 42
20SLBTC	89, 108, 116, 125	41PRV.....	210, 217	680T.....	6, 36, 40
				840M	6, 41
				840ME.....	6, 40, 43
				840MG	6, 40
				840MH	6, 41
				840MX2.....	6, 37
				840P.....	6, 40
				840PW3.....	6, 36, 42
				840PW5.....	6, 36, 42
				840PX2	6, 37
				840PX2W3	6, 36, 37
				840PX2W5	6, 36, 37
				840T.....	6, 36, 40
				840TX2.....	6, 36, 37
				860H	6, 41
				860P.....	6, 36, 42
				860T.....	6, 36, 40
				880P.....	6, 42
				880T.....	6, 36, 40
				911CP	16
				911CR	16
				911HP.....	16
				911HR.....	16
				1040.....	6, 41
				3420.....	200
				3421.....	199
				3422.....	200
				3902.....	200
				3914.....	199
				4611.....	176
				4612.....	94, 95, 96, 97,
					105, 106, 108,
					110, 111, 116,
					118, 119, 121,
					125, 129, 134,
					141, 144, 147,
					154, 159, 160,
					161, 184, 203,
					204, 206
				4621.....	232
				4696.....	142, 196
				5454.....	197
				5457.....	197
				5458.....	197
				6059.....	165, 170
				7714.....	141, 161
				15921	221
				15922	224, 232
				15923	221
				15924	229
				17761	231
				21052	232
				21821	141, 148
				23611	219, 221, 224,
					225, 230, 232
				23612	221
				23613	221

Part Number	Page Number			
26701.....	228		141, 154, 164,	CAB15HASYS5 212
26781-EDP30	228		188	CAB15PM..... 214
26781-EDP50	228	AC100037	94, 110, 129,	CAB15RAUPGRADE.... 213, 214
27161.....	228		141, 154, 164,	CAB30..... 211, 217
28151.....	228		188, 203	CAB30FA 216
28152.....	228	AC100038.....	129, 141, 164,	CAB30FB 216
30013.....	22, 27		188, 203	CAB30FC..... 216
36501.....	94, 105, 106,	ADFB	6, 12	CAB30FCI 217
	108, 110, 116,	ADH20	27	CAB30FEA..... 216
	118, 125, 184,	ADP20.....	131, 143, 187,	CAB30FEB..... 216
	203		218, 219, 221,	CAB30FEC 216
46913.....	196		222, 225, 230,	CAB30FK 216
46915.....	196		231, 232	CAB30IRHA..... 97, 213
46916.....	196	ADRTSL	7, 8, 11, 27	CAB30PM..... 214
46917.....	196	AFW45	171, 179	CAB30PMIR..... 214
46918.....	196	B1.....	34	CAB50..... 211, 217
46919.....	196	B2.....	34	CAB50FA 217
54510.....	197	B88VXLC.....	151	CAB50FB 217
54511.....	197	B771B.....	152	CAB50FC..... 217
54512.....	197	B771D015	152	CAB50FCIA..... 217
54513.....	197	B771R.....	152	CAB50FCIB..... 217
54514.....	197	B771R015.....	152	CAB50FEA..... 217
222752	222	B771R020.....	152	CAB50FEB..... 217
244852	222, 225, 230,	B771020	152	CAB50FEC 217
	232	B771040	152	CAB50FK 217
263552	222, 225, 230,	BC.....	24, 25	CAB50PM..... 214
	232	BCHBP	25, 27	CAB50PMHA..... 214
272556	203	BCHBV	25, 27	CAB50PMIR..... 214
469650	188, 196	BCP	25	CAB100 211
4696100.....	166, 196	BCRBPP.....	25, 27	CAB100FA..... 217
A1	8, 31	BCRBPV.....	25, 27	CAB100FB..... 217
A1S	8	BCV	25	CAB100FC..... 217
A2	8, 31	BFW.....	151	CAB100FCIA..... 217
A2S	8	BGVXLL.....	138	CAB100FCIC 217
A101	11, 27	BGVXOL15.....	138	CAB100FEA 217
A110	8, 12, 27	BGVXOL40.....	138	CAB100FEB 217
AC1000	130, 185, 187	BHA.....	172, 176	CAB100FEC 217
AC1000DC.....	205	BT135	166	CAB100FK..... 217
AC100030.....	94, 110, 118,	C20LFL35.....	111	CAB100MB
	129, 141, 154,	C30P.....	15, 86, 102, 154,	CAB100PM 214
	164, 188, 203		157	CAB100PMIRHA 214
AC100030B	94, 110, 118,	C30R.....	15, 60, 82, 83, 84,	CABCALREG 216
	129, 141, 154,		94,	CABCALREG103 216
	164, 188		100, 154	CABCG0 216
AC100030S	94, 110, 118,	C33P.....	15, 16	CABCG10 216
	129, 141, 154,	C34R.....	15	CABCG017L 216
	164, 188	CA30.....	172, 174, 175	CABCG0103L 216
AC100031.....	94, 110, 118,	CA31.....	175	CABCG0103L..... 216
	129, 130, 141,	CA32.....	175	CABCK..... 216
	154, 164, 188,	CA33.....	175	CABCK17L..... 216
	203	CA34.....	175	CABCK103L 216
AC100032.....	94, 110, 118,	CA37.....	175	CABCORDAU 217
	129, 141, 154,	CAB15.....	211, 213, 214	CABCORDEU 217
	164, 188, 203	CAB15FCI	217	CABCORDJA..... 217
AC100033.....	94, 110, 129,	CAB15HA88VXSYS	212	CABCORDUK 217
	141, 154, 164,	CAB15HA88VXSYS5... 212		CABFR..... 217
	188, 203	CAB15HARAJ.....	213, 214	CABKS..... 216
AC100034.....	94, 110, 129,	CAB15HASYS	212	
				CABPC..... 217
				CABQDCAP 217
				CABQDCE 217
				CABQDHA 217
				CABQDNV..... 217
				CABQDSC 217
				CABQDSN..... 217
				CABQDSS 217
				CABREG1 217
				CABREG2 217
				CABREG3 217
				CABREG4 217
				CABREGTB..... 216
				CABRS2 216
				CC20CABSYS..... 97
				CC20CABSYS2M..... 97
				CC20ICESYS..... 50
				CC20LF2L30 111
				CC20LF2M30..... 111
				CC20LF2S30 111
				CC20LF35..... 97
				CC20SIC30 96
				CC20SYS 50, 97
				CC20SYS2M 97
				CC20SYS50..... 97
				CC20TIC35 97, 111
				CC20TICH30 96
				CC20TICH35 97
				CC20TJ30..... 95
				CC20TP30RT 95
				CH60 205
				CH1000 205, 206
				C05HP..... 212
				C05HP41P2..... 208, 212
				C05HP41P2CABCK 208, 212
				C05HP41P2WMCABCK.. 208, 212
				C05HP41P6..... 208, 212
				COHP 212
				COHP41P2 208, 211, 212
				COHP41P2CABCK..... 208, 212
				COHP41P2CC20..... 208
				COHP41P2WMCABCK... 208, 212
				COHP41P6 208, 211, 212
				COHP41P288VX..... 208
				COHPAK..... 212, 216
				COHPCC 212
				COHPKIT..... 216
				COM5 216
				COM10 216
				CP1 37
				CP2 37
				CS40..... 6, 41
				CSS..... 23, 27
				CT30 129, 130, 141,
				164, 203
				CT30B 129, 141, 164,
				203
				CT30BSW 129, 141, 164,

Part Number	Page Number				
	203	EDP10.....	97, 155, 166,	EVA20SICT.....	63
CT30DC.....	205		182, 190, 191,	EVA20TIC.....	62, 76
CT30S.....	129, 141, 164,		192, 218, 219,	EVA20TICH.....	63, 77
	203		220, 221, 222,	EVA20TICHT.....	63
CT30SSW.....	129, 141, 164,		225, 230, 232	EVA20TICS.....	62, 76
	203	EDP10HM.....	220	EVA20TICST.....	62
CT30SW.....	129, 141, 164,	EDP10PRV.....	221	EVA20TICT.....	62
	203, 204	EDP16HAZ.....	218, 224, 225,	EVA20TJ.....	62
CT31.....	129, 130, 141,		226	EVA20TJT.....	62
	164, 203	EDP16HAZW.....	224	EVA20TP.....	62
CT32.....	129, 141, 164,	EDP16TE.....	131, 218, 219,	EVABAT1.....	65, 71, 72, 79
	203		221, 222, 223,	EVABAT2.....	65
CT33.....	129, 141, 164,		224, 225, 226,	EVABELT1.....	60, 66, 70, 71,
	203		230, 232		72, 76, 80
CT34.....	129, 141, 164	EDP16TE60HZ220V ...	223	EVABELT2.....	60, 66, 70, 71,
CT37.....	129, 141, 164,	EDP16TEW.....	223		72, 80
	203	EDP30A230.....	227	EVABKPK1.....	70, 72
CT38.....	129, 141, 164,	EDP30B208.....	227	EVABP1.....	66
	203	EDP30B230.....	227	EVABP2.....	66
CTF.....	203	EDP30B460.....	227	EVABPCFR1.....	70, 72
CYL5H.....	174	EDP30C230.....	227	EVABUCKLE.....	66
CYL10H.....	174	EDP30C460.....	227	EVACAPBLK.....	66
CYL455.....	174	EDP30WHEEL.....	228	EVACAPRED.....	66
CYL4510.....	174	EDP50A208.....	227	EVADCFR1.....	70, 72
DC70ML.....	94, 110, 118,	EDP50A230.....	227	EVAEXT1.....	70, 80
	129, 141, 154,	EDP50B208.....	227	EVAFAML.....	64
	205	EDP50B230.....	227	EVAFAMM.....	64
DC70XLXXL.....	94, 110, 118,	EDP50B460.....	227	EVAFAMS.....	64
	129, 141, 154,	EDP50C208.....	227	EVAGC.....	60, 70
	205	EDP50C230.....	227	EVAGRH.....	63
DC705XL.....	94, 110, 118,	EDP50C460.....	227	EVAHL1.....	51, 75, 76, 79
	129, 141, 154	EDP50WHEEL.....	228	EVAHL2.....	79
DC5040.....	94, 110, 118,	EDP1050HZ220V.....	220, 221	EVAHL3.....	79
	129, 141, 154,	EDP1050HZ220VHM ..	220	EVAHL4.....	79
	205	EDPPRV.....	221	EVAHL5.....	79
DC5040B.....	94, 110, 118	ES3.....	22, 27	EVAHL20LF2L.....	78
DC5040S.....	94, 110, 118	ES42.....	22, 25, 27, 60,	EVAHL20LF2M.....	78
DC5041.....	94, 110, 118,		87, 94, 103, 158	EVAHL20LF2S.....	78
	129, 141, 154,	ES42B.....	22, 25, 27	EVAHL20LFL.....	78
	205	EVA.....	51, 59, 60, 61,	EVAHL20LFM.....	78
DC5042.....	94, 110, 118,		62, 63, 64, 65,	EVAHL20SICHT.....	77
	129, 141, 154,		71, 75, 76, 77,	EVAHL20SICT.....	77
	205		78, 79, 93	EVAHL20TICHT.....	77
DC5043.....	94, 110, 118,	EVA1.....	65, 70, 71, 72, 79	EVAHL20TICST.....	76
	205	EVA2.....	65, 70, 72, 79	EVAHL20TICT.....	76
DC5044.....	94, 110, 118,	EVA3.....	65, 70, 72, 79	EVABL20TICT.....	76
	129, 141, 205	EVA4.....	65, 79	EVABLGC.....	60, 79
DC5047.....	94, 110, 118,	EVA5.....	65	EVAPAN1.....	77
	129, 141, 154,	EVA6.....	65	EVAPAN2.....	77
	205	EVA7.....	65	EVAPAN1.....	64, 77
DC5048.....	205	EVA20LF2L.....	64, 78	EVAPAN2.....	64, 77
DCHS.....	205	EVA20LF2M.....	64, 78		
E840ME.....	6, 36, 43	EVA20LF2S.....	64, 78		
EARMUFFSM.....	21, 27	EVA20LFL.....	64, 78		
ECB.....	23, 27	EVA20LFM.....	64, 78		
ECCN.....	23, 27	EVA20SIC.....	63, 77		
ECVL.....	45	EVA20SICH.....	63, 77		
ECVXL.....	45	EVA20SICHT.....	63		
				EVART1T.....	62
				EVART2.....	63
				EVART3.....	62
				EVART3T.....	62
				EVART4.....	63
				EVART4T.....	63
				EVASL1.....	71
				EVASL1NC.....	71
				EVASL2.....	71
				EVASMC.....	60, 65, 70, 71,
					72, 79
				EVASMC2.....	60, 65, 79
				EVASMCAU.....	65, 79
				EVASMCEU.....	65, 79
				EVASMCPS.....	65
				EVASMCUK.....	65, 79
				EVASPECL.....	64
				EVASPECS.....	64
				EVO.....	165, 170, 179
				EVDPK.....	169, 173, 177
				EVX30.....	144
				EVX31.....	144
				EVX32.....	144
				EVX33.....	144
				EVX35.....	144
				EVX37.....	144
				EVX38.....	144
				EVX40.....	144
				EVX41.....	144
				EVX42.....	144
				EVX43.....	144
				EVX47.....	144
				EVX48.....	144
				F30.....	94, 95, 96,
					104, 105, 110,
					113, 114, 118,
					119, 121, 123,
					129, 130, 133,
					141, 142, 143,
					145, 154, 155,
					159, 167, 182
				F30B.....	94, 105, 110,
					114, 118, 123,
					129, 141, 154
				F30S.....	94, 105, 110,
					114, 118, 123,
					129, 141, 154
				F30SD.....	105, 114, 123
				F30VDB.....	105, 114, 123
				F31.....	94, 104, 105,
					110, 113, 114,
					118, 121, 123,
					129, 133, 142,
					145, 154, 164,
					167, 188
				F32.....	94, 104, 105,
					110, 113, 114,
					118, 122, 123,

Part Number	Page Number				
MB1.....	154, 155, 161	R1	34	RT2	60, 82, 118, 120
MCK.....	165, 170, 173, 179	R2	34	RT2DA.....	120
MKHB	25	R50	22, 27	RT2T.....	82
MP771020	152	R160.....	12, 21, 27	RT3	60, 62, 82, 118,
MPT71B.....	152	R325.....	12		119, 120
NMXBTC.....	89	R330.....	12	RT3DA.....	120
O1.....	34	R538.....	35	RT3T.....	60, 62, 82
O2.....	34	R540.....	35	RT4	60, 63, 77, 82,
O7.....	34	R541.....	35		118, 119, 120
OR145.....	13	RA.....	216	RT4DA.....	120
OR308.....	13	RA45B.....	172, 174	RT4T.....	82
OR309.....	13	RACABLE	216	RT330	119
OR310.....	13	RAK.....	169, 173, 177	RT430	119
OR311.....	13	RAM1.....	211, 215	RTBT.....	118, 125
OR315.....	13	RAM1HA.....	215	RTL.....	85, 118, 125
OR316.....	13	RAM1WMHA	215	S4	34
OR320.....	13	RAM2.....	211, 215	S5	34, 35
P771B.....	152	RAM2IR.....	215	S51P.....	18, 86, 102,
P771R.....	152	RAM2IRHA.....	215		154, 157
P771020.....	152	RAM4.....	211, 215	S51R.....	18, 60, 82, 83,
PA1AFI.....	71, 76, 89	RAM4IR.....	215		84, 94, 100, 154
PA1BT	60, 88	RAM4IRHA.....	215	S61P.....	18
PA1BTS4.....	89	RAM8.....	211, 215	S61R.....	18
PA1BTXL.....	60, 88	RAM8IR.....	215	S62P.....	18
PA1BTXS.....	60, 88	RAM8IRHA.....	215	S71P.....	18
PA3IS.....	60	RBPCOOL	15, 16, 18, 19,	S71R.....	18
PA4AFI.....	89		20, 21, 27, 85,	S2084	229
PA4BT	60, 88		86, 87, 101,	S2089	229
PA20LFBT	60, 88		102, 103, 136,	S2090	229
PA20LFBTXL	60, 88		149, 156, 157,	S09853	231
PA20LFBTXS	88		158, 237	S16191	225, 228, 232
PAFAMBT	60, 88	RBPCOTTON	15, 16, 18, 19,	S16481	220, 225
PAHBT.....	60, 70, 71, 76, 88		20, 21, 27, 85,	S16483	221
PAHBTBK.....	70		86, 87, 101,	S17101	221, 222, 224,
PAHBTXL.....	60, 70, 88		102, 103, 136,		225, 230, 232
PAHBTXS.....	60, 70, 88		149, 156, 157,	S17456	217
PAPRBAG	70, 89		158	S17931	222, 225, 230, 233
PAPRFC3.....	65, 70, 71, 72, 79	RBPVINYL	15, 16, 18, 19,	S18051	108, 121, 125, 159,
PAPRFC4.....	65, 79		20, 21, 27, 85,		161, 205
PAPRFC40CP.....	65		86, 87, 101,	S18051BLACK.....	108, 125, 161
PAPRFC41CP.....	65		102, 103, 136,	S18052	184
PAPRPF2.....	60, 66, 80		149, 156, 157,	S19432	200
PAPRPF COVER2	80		158	S19433	200
PAPRSC2.....	80	RLS.....	165, 169, 173, 177	S19442.....	200
PAPRSC3.....	80	RS4PC.....	18, 20, 27	S19443.....	200
PAPRSUSP1	80	RS4PP.....	18, 20, 27	S19683.....	221, 224,
PASPEC.....	60	RS4PV.....	18, 20, 27		229, 232
PASPECL.....	84	RS4RB.....	18, 20, 27, 157	S19688.....	229
PASPECS	60, 84	RS4RC.....	18, 20, 27, 87,	S196810.....	217
PDR45.....	172, 174		103, 158	SARHBT	189, 190,
PDR45B.....	174	RS4RP.....	18, 20, 27, 157		191, 192
PKVX.....	129, 130, 135	RS6PC.....	15, 16, 19, 27	SB.....	34
PKXLVX.....	135	RS6RC.....	15, 16, 19, 27,	SEK	165, 170,
PL	170, 179		87, 102, 103,		173, 179
PMFC2.....	184		157, 158	SENTINEL1	6, 37
POLYBTC	89, 108, 116, 125	RT1	60, 82, 118, 120	SENTINEL2	6, 37
PPEBAG.....	89	RT1DA.....	120	SG.....	34
QNFT45	171, 180	RT1T.....	60, 62, 82	SLADF.....	72, 193
				SLALA.....	72, 193
				SLBAT1	72, 193
				SLCLP	72, 193
				SLFCL.....	72, 193
				SLGL.....	72, 193
				SLH	70, 71, 72,
					188, 190,
					191, 192,
					193
				SLHCA	72, 193
				SLHG	72, 193
				SLPBA.....	72, 193
				SLRCL	72, 193
				SLS1.....	70, 72,
					189, 190,
					192, 193
				SLS1AC100030	191
				SLS1AC100031	191
				SLS1AC100032	191
				SLS1AC100033	191
				SLS1AC100034	191
				SLS1AC100037	191
				SLS1AC100038	191
				SLS1HC240030	192
				SLS1HC240031	192
				SLS1HC240032	192
				SLS1HC240033	192
				SLS1HC240034	192
				SLS1HC240037	192
				SLS1HC240038	192
				SLS2.....	70, 72,
					189, 190,
					191, 192,
					193
				SLS2AC100030	191
				SLS2AC100031	191
				SLS2AC100032	191
				SLS2AC100033	191
				SLS2AC100034	191
				SLS2AC100037	191
				SLS2AC100038	191
				SLS2HC240030	192
				SLS2HC240031	192
				SLS2HC240032	192
				SLS2HC240033	192
				SLS2HC240034	192
				SLS2HC240037	192
				SLS2HC240038	192
				SLS130.....	190
				SLS131.....	190
				SLS132.....	190
				SLS133.....	190
				SLS134.....	190
				SLS135.....	189
				SLS137.....	190
				SLS138.....	190
				SLS140.....	190
				SLS141.....	190

Part Number	Page Number						
SLS142.....	190	SPECPDE10S.....	172	V5KF5031XXX.....	195	182, 197, 220	
SLS143.....	190	SPECPDLA.....	172	V5KF5032XXX.....	195	VANE1620.....	224, 232
SLS144.....	190	SPECPDML.....	172, 177	V5KF5033XXX.....	195	VANEEDP10.....	221
SLS147.....	190	SPECPDS.....	177	V11.....	197	VECTOR-C.....	10
SLS148.....	190	SPECPDSA.....	172	V12.....	197, 199, 200	VECTOR-CRT.....	10
SLS230.....	190	SR.....	34	V13.....	196, 197, 200	VT600.....	9, 10, 11, 27
SLS231.....	190	SS5.....	23, 27	V14.....	199	VTP.....	10
SLS232.....	190	SS6.....	23, 27	V15.....	199, 210	VTR.....	10
SLS233.....	190	ST1R.....	34, 35	V17.....	196, 200	VTRT600.....	10, 11, 27
SLS234.....	190	ST1R500.....	34, 35	V18.....	199	VTS.....	11
SLS235.....	189	ST1RBLU.....	34	V19.....	199	W1.....	34
SLS237.....	190	ST1RGRN.....	34	V19B.....	199	W2.....	34
SLS238.....	190	ST1RORG.....	34	V22.....	222, 225, 226, 230, 233	WKIT16.....	220, 223
SLS240.....	191	ST1RORG175.....	34, 35	V23.....	222, 226, 230, 233	WS60PM.....	6
SLS241.....	191	ST1RRED.....	34	V24.....	222, 226, 230, 233	WS60TM.....	6, 36
SLS242.....	191	ST1RWHT.....	34	V25HA.....	217	X30.....	113
SLS243.....	191	ST1RYLW.....	34	V27.....	199	X31.....	113
SLS244.....	191	ST2R.....	34	V30.....	95, 96, 104, 119, 121, 155, 159	X32.....	113
SLS247.....	191	ST2RBLU.....	34, 35	V31.....	104, 121	X33.....	113
SLS248.....	191	ST2RGRN.....	34, 35	V32.....	104, 122	X35.....	97, 113
SLSBA.....	72, 193	ST2RORG.....	34, 35	V33.....	104, 122	X40.....	113
SLSHELLBLU.....	72, 193	ST2RRED.....	34, 35	V35.....	97, 104, 122, 155, 159	Y2.....	34
SO.....	34	ST2RWHT.....	34, 35	V40.....	104, 121, 159		
SPEC35L.....	166	ST2RYLW.....	34, 35	V41.....	104, 121		
SPEC35S.....	166	STRSS.....	34, 35	V42.....	104, 122		
SPEC40L.....	166	STRSS500.....	34, 35	V43.....	104, 122		
SPEC40S.....	166	STRSSBLU.....	34	V50EX.....	219, 222, 226, 230, 233		
SPECBT.....	167	STRSSGRN.....	34	V50IN.....	219, 222, 226, 230, 233		
SPECCFML.....	166, 167	STRSSORG.....	34	V60.....	228		
SPECCFS.....	166, 167	STRSSORG175.....	34, 35	V1000.....	203, 204, 205, 206		
SPECICESYS.....	50	STRSSRED.....	34	V2050ST.....	97, 131, 143, 188, 197		
SPECIVK.....	165, 169, 173, 178	STRSSWHT.....	34	V20100ST.....	97, 131, 155,		
SPECLCABSYS.....	166, 212	STRSSYLW.....	34				
SPECLCABSYS2M.....	166	SW.....	34				
SPECLCABSYS5.....	212	TT3.....	11, 27, 37				
SPECLSYS.....	50, 166	UBG.....	23, 27				
SPECLSYS2M.....	166	V5KF2530XXX.....	195				
SPECLSYS50.....	166	V5KF2531XXX.....	195				
SPECPDE5L.....	172, 174	V5KF2532XXX.....	195				
SPECPDE5S.....	172	V5KF2533XXX.....	195				
SPECPDE10L.....	172	V5KF5030XXX.....	195				



Subject Index

41 Series Airline Filter ... 207-210 <i>Replacement</i> 210	Constant Flow Respirator95-97, 119 Credit 1	GR50 Airline Respirator153, 161 <i>Belt</i> 161 <i>Breathing Tube</i> 159-160 <i>Lenses</i> 161 <i>Replacement</i> 156, 158 <i>Selection Chart</i>154	Spectrum Series Respirator 162-180 <i>Breathing Tubes</i> 167 <i>Continuous Flow</i> 167-169, 171 <i>Pressure Demand</i>172-179, 180
88VX Series Airline Respirators 139-152 <i>Belt</i> 147 <i>Breathing Tube</i> 147 <i>Lenses</i> 151-152 <i>Maintenance Kit</i> 150 <i>Replacement</i> 133-140 145-152 <i>Selection Chart</i>141	Decoration 29-35 Disposable Respirator 120 EDP10 220-221 <i>Replacement</i> 221-222	Grinding126-161 HEPA Filter Cartridges 171, 180	Standards <i>Head Protection</i> 4 <i>Face Protection</i> 5-6 <i>Respiratory</i> 49-59
Abrasive Blasting 126-161	EDP16TE 223-226 <i>Replacement</i> 224-226	HEPA Protection 171, 180	Standard Series Hard Hat 17-18 <i>Replacement</i> 19-20
ADP20 231 <i>Replacement</i> 231-233	EDP30 227-230 <i>Replacement</i> 228-230	High Heat Hard Hats 16	Stripping 34-35
Advent 7-8 <i>Customization</i> 13 <i>Replacement</i> 11-12	EDP50 227-230 <i>Replacement</i> 228-230	Hoses 194-200	Supplied Air Respirators 90-125
Air Driven Pump 231-233	Electric Driven Pumps 218-230	Hot/Cold Tubes 201-206	Terms 1
Airflow Chart 59	Emergency Response 7-8	Ice Pump 219-220 <i>Replacement</i> 219-220	Turtle Club 46-47
Air Quality and Filtration .. 207-233	EVA 61-66 <i>Batteries</i> 65 <i>Belt</i> 66 <i>Breathing Tubes</i> 88 <i>Filter</i> 65 <i>Head Protection</i> 86 <i>Replacement</i> 65	Isotherm Cool Vest 44-45	V5 Coiled Hose 195
Aluminum Brackets 39	EVAHL 75-80 <i>Batteries</i> 79 <i>Belt</i> 80 <i>Breathing Tubes</i> 88 <i>Filter</i> 79 <i>Head Protection</i> 86 <i>Replacement</i> 79-80	Logos 28-35	V10 3/8" ID Hose 196
Batteries 65, 79	Evaporative Cooling 23, 44-45	Mylar Lens 85, 101, 151, 161, 171, 179	V20 1/2" ID Hose 197
Belts 66, 80, 161, 176, 184	Face Protection 36-43	Nylon Brackets 38	Vector 9-10 <i>Customization</i> 13 <i>Replacement</i> 11-12
Blowers 65, 79	FAMB 181-184 <i>Breathing Tubes</i> 184 <i>Components</i> 183 <i>Fit Test Kit</i> 184	PAPRs 59-89	Visors 40-43
Brackets 38-39	Filters 65, 79	PAPR Selection Chart 60	
Breathing Air Supply Hose 194-200	First Base Bump Cap 26	Paramedics 7-8	
Breathing Tubes 88, 89, 159, 160, 167, 184	Free-Air Pumps 218-233 <i>Hose</i> 196	Personal Climate Devices ...201-206	
Bump Caps 22, 24, 25, 26, 38, 39, 158	Freight 1	Quick-Disconnect Couplers 199	
CC20 Airline Respirator .. 93-109 <i>Belt</i> 105-109 <i>Breathing Tube</i> 104, 109 <i>Head Protection</i> 102-103, 157-158 <i>Replacement Parts</i> 103-109 <i>Selection Chart</i> 94	Gang Charger 65, 79	Quick-Disconnect Nipples 200	
Chin Protector 37	GenVX 127-138 <i>Belt</i> 136 <i>Breathing Tube</i> 136 <i>Lenses</i> 138 <i>Maintenance Kit</i> 137 <i>Replacement</i> 136-138 <i>Selection Chart</i> 129	Respirator Selection 49	
Classic Series Hard Hat ... 14-16 <i>Replacement</i> 19-21		RT Airline Respirator 117-125 <i>Belts</i> 125 <i>Breathing Tubes</i> 125 <i>Replacement</i> 123-125 <i>Selection Chart</i> 118	
Clean Air Box 211-218		<i>Sentinel</i> 37	
		SparxLift Series Welding Powered Air-Purifying Respirator .. 67-72 <i>Systems</i> 71 <i>Replacement</i> 72 <i>Selection Chart</i> 70	
		SparxLift Welding Helmet for Supplied Air Respirators 185-193 <i>Systems</i> 189-192 <i>Replacement</i> 193 <i>Selection Chart</i> 188	



Experience Build Your Bullard...



- The industry's first complete online product configurator
- Configure your Respiratory and Head Protection at www.BuildYourBullard.com

Easy. Complete. Personal.





www.bullard.com



Join our click.

www.bullard.com 

- Detailed Product Information
- Promotions and Giveaways
- Distributor Locator
- Shipment Tracking
- Hi-Res Photo Galleries
- Like Bullard on Facebook 
- View Our Product Videos on BullardTV 
- F.A.Q. - Frequently Asked Questions
- Downloads (Manuals, Brochures, etc.)
- Company and Product History
- Fully Searchable



Americas:

Bullard
1898 Safety Way
Cynthiana, KY 41031-9303 • USA
Toll-free within USA: 877-BULLARD (285-5273)
Tel: +1-859-234-6616 • Fax: +1-859-234-8987

Europe:

Bullard GmbH
Lilienthalstrasse 12
53424 Remagen • Germany
Tel: +49-2642 999980 • Fax: +49-2642 9999829

Asia-Pacific:

Bullard Asia Pacific Pte. Ltd.
LHK Building
701, Sims Drive, #04-03 • Singapore 387383
Tel: +65-6745-0556 • Fax: +65-6745-5176

©2016 Bullard. All rights reserved. Bullard Advent, First Base, Flex-Gear, Free-Air, GenVX, Hard Boiled, Isotherm, Spectrum Series, Sure-Lock, Three Rib Design, and Turtle Club are registered trademarks of Bullard. Velcro is a registered trademark of Velcro USA. Eastman and Tritan are trademarks of Eastman Chemical Company. Scotchlite is a registered trademark of 3M Company. Mylar and Tychem are registered trademarks of E. I. du Pont de Nemours and Company. Polartec is a registered trademark of Polartec Fabrics. Dynaswivel® is a registered trademark of DYNABRADE. Tyson® is a registered trademark of Saint-Gobain Performance Plastics.